



40th EKF Junior&Cadet Karate Champ. 5th Under 21

TURKEY - Konya

8/2/2013 - 10/2/2013

Cadet Kumite Female 54+ kg

Entries: 24

AUT257 J.WAEGER [1]
ENG347 N.BAILEY [2]
POR251 A.OLIVEIRA []
<BYE>
SRB276 T.ZUNIC [7]
SCO212 O.HAND [0]
MNE190 J.MATOVIC []
<BYE>
TUR742 Z.COSKUN [3]
RUS527 V.KERIMOVA [0]
CZE247 L.JANOUCHOVA []
<BYE>
FRA527 I.HASSOUNI [3]
BLR234 A.DZYACHKOVA [0]
BIH304 M.BEKTAS []
<BYE>
SLO280 Z.MAGAJNA [1]
LUX156 S.DOS SANTOS [0]
FIN190 J.SALONEN []
<BYE>
CRO376 I.PRGA [8]
FYR282 S.SIMONOSKA [0]
AZE263 F.ALIYEVA []
<BYE>
HUN282 T.PAL [0]
UKR320 I.SIROSH [8]
DEN205 S.PEDERSEN []
<BYE>
GRE674 N.VROUTSI [0]
GER431 A.MIGGOU [6]
SVK337 H.KUKLOVA []
<BYE>

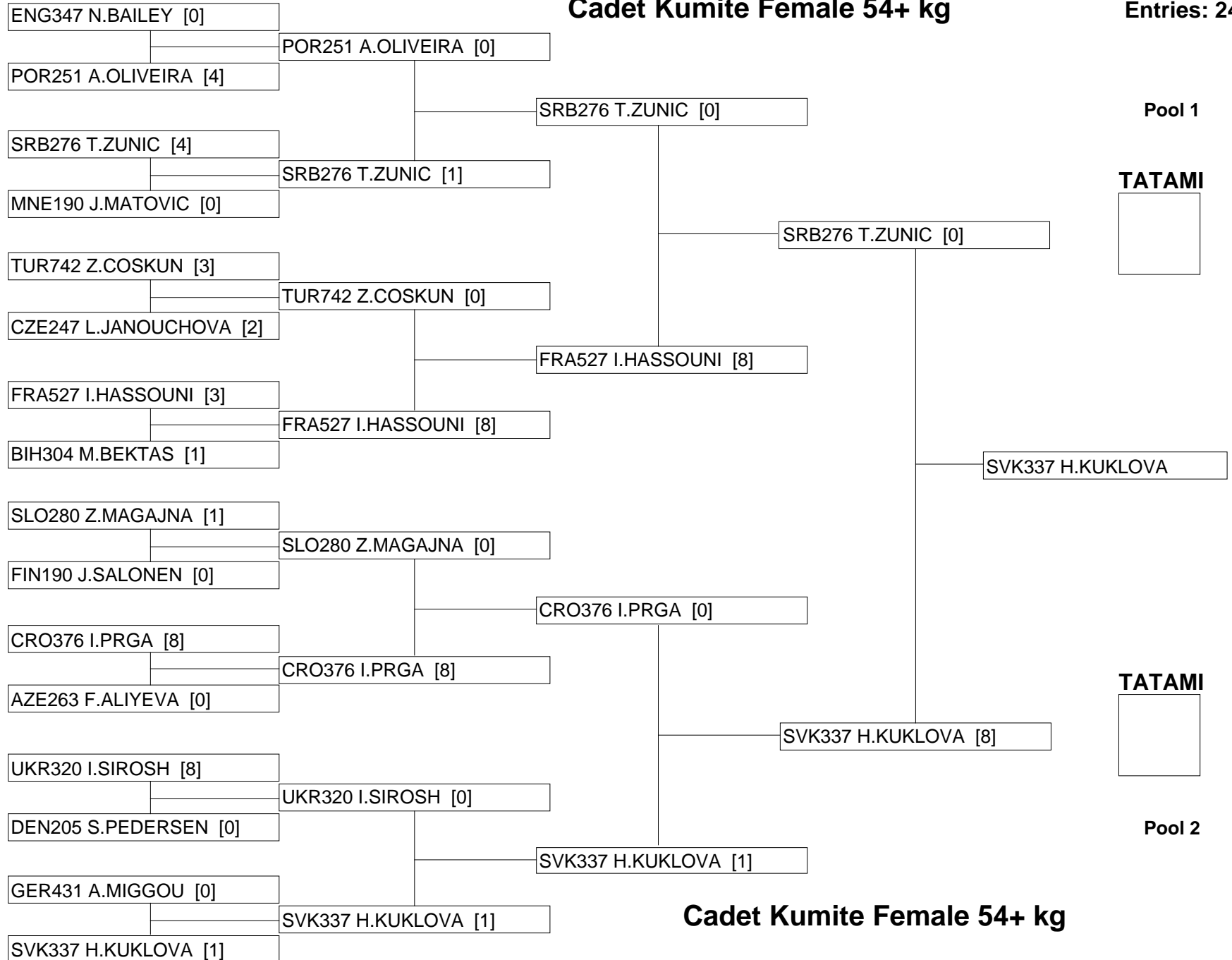



40th EKF Junior&Cadet Karate Champ. 5th Under 21

TURKEY - Konya

8/2/2013 - 10/2/2013

Cadet Kumite Female -47 kg

Entries: 23

AZE265 A.MALIKOVA [0]
GER509 S.HUBRICH [1]
SRB267 T.PAVLOVIC []
<BYE>
RUS630 D.ASADULLINA [0]
UKR286 G.CHEGOLYA [5]
FRA529 L.LAMBERT []
<BYE>
LUX154 L.DA NAZARE [0]
FYR366 M.PENDAROVSKA [8]
BIH365 S.ORASCANIN []
<BYE>
HUN281 R.KISS [2]
GRE485 A.ZISI-NATSI [4]
SUI267 M.SCHAERER []
<BYE>
SLO279 Z.KUSTRIN [0]
SCO213 C.PENDREICH [8]
SVK338 R.VIDOVA []
<BYE>
POR250 A.SILVA [4]
AUT249 J.REITER [0]
BEL208 Y.FARSI []
<BYE>
CRO364 I.GRDENIC [1]
LAT225 A.PAVLOVA [0]
TUR746 H.UNLUSOY []
<BYE>
ENG348 K.DALZELL []
<BYE>
MNE243 A.JOVIC []
<BYE>



Pool 1

TATAMI



TATAMI

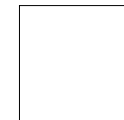

Pool 2

Cadet Kumite Female -47 kg



40th EKF Junior&Cadet Karate Champ. 5th Under 21

TURKEY - Konya

8/2/2013 - 10/2/2013

Cadet Kumite Female -47 kg

Repechage Pool 1

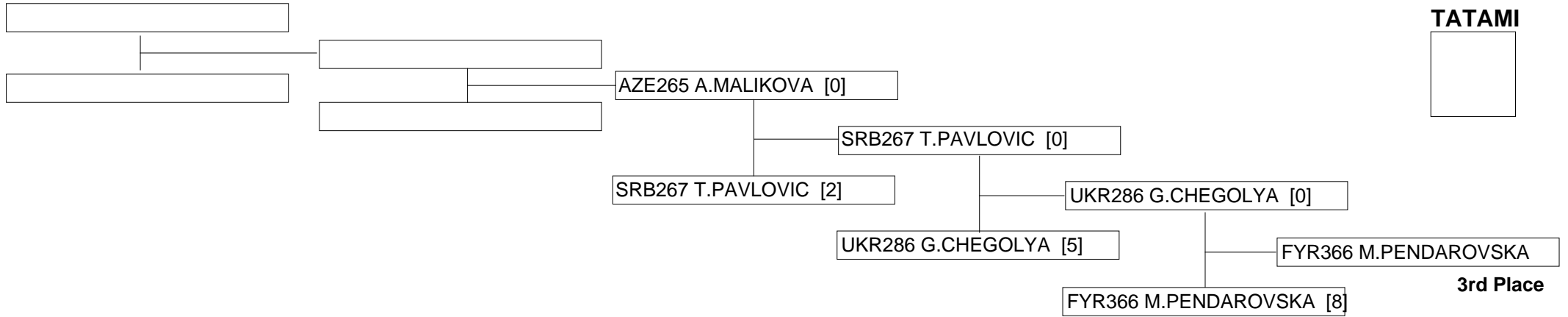

Repechage Pool 2

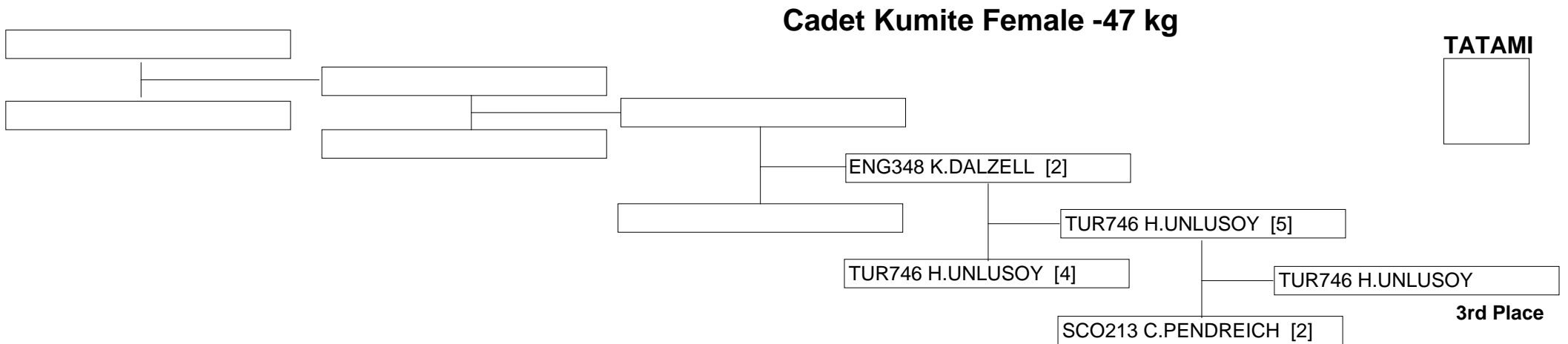



40th EKF Junior&Cadet Karate Champ. 5th Under 21

TURKEY - Konya

8/2/2013 - 10/2/2013

Cadet Kumite Female -54 kg

Entries: 28

FRA506 A.BRITO [0]
TUR651 K.DEMIRTURK [4]
ENG349 F.HARDCASTLE [1]
FIN193 T.KAUPPINEN [0]
AZE262 A.ALIYEVA [1]
FYR328 M.VASILEVA [0]
SVK334 M.KOZMOVA []
<BYE>
EST204 L.LIRISMAN [8]
SLO281 N.ROM - ZUPANC [0]
ISR153 T.BENAROCHE [4]
AUT261 N.VORDERLEITNER []
SRB404 T.ZIVIC [0]
GRE399 G.XYLIKIOTI [1]
BEL223 D.CAVRAINE []
<BYE>
CRO361 N.DESA [5]
UKR317 O.PAVLOVA [0]
RUS633 E.LAZAREVA [0]
GER513 J.ROEHL [1]
HUN241 A.BOUSSEBAA [2]
MNE203 N.KILIBARDA [2]
POR243 D.PIRES []
<BYE>
ITA515 A.STAGLIOLI [3]
SCO207 K.JOHNSTONE [3]
SWE201 A.NILSSON [0]
GEO172 T.TURMANIDZE [1]
LUX152 A.BERNA [0]
BIH285 D.TADIC [0]
DEN203 C.ALBERG []
<BYE>

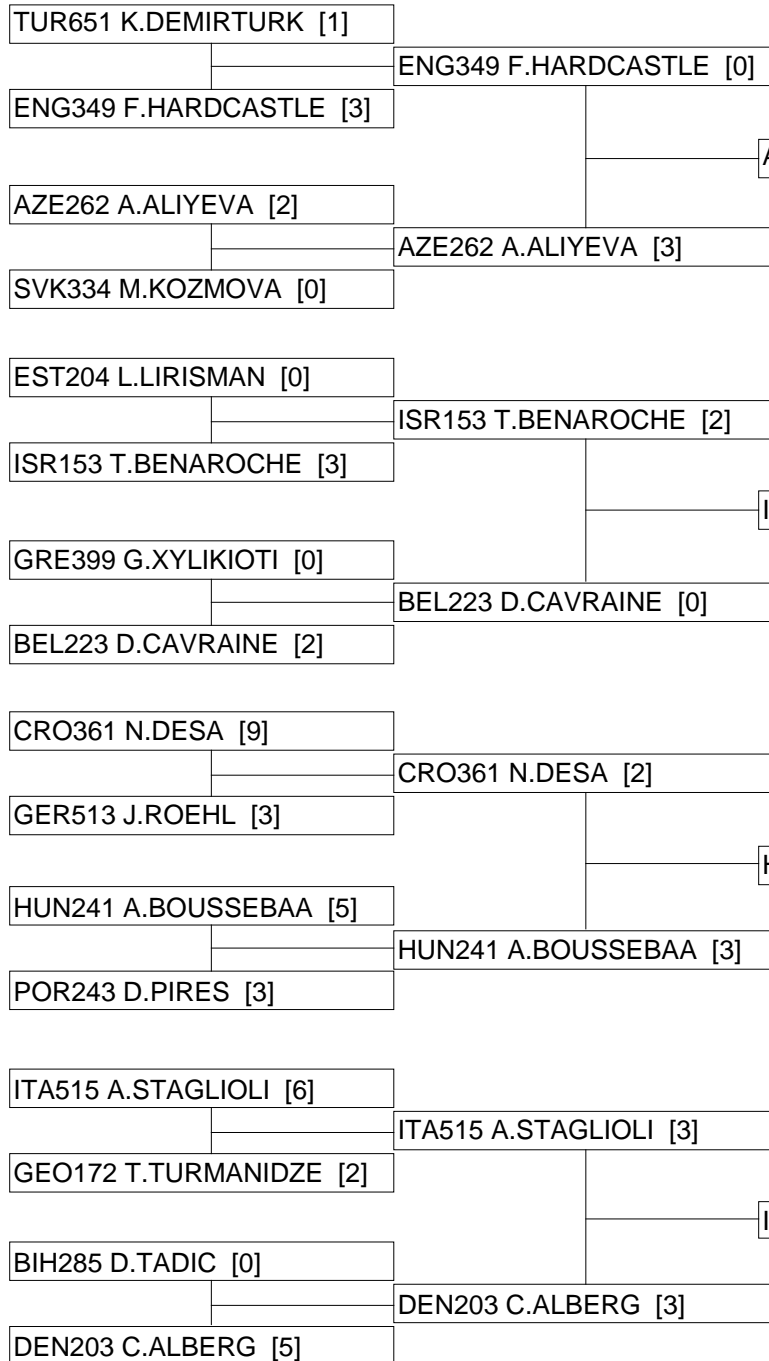

Pool 1

TATAMI



TATAMI

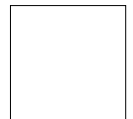

Pool 2

Cadet Kumite Female -54 kg



40th EKF Junior&Cadet Karate Champ. 5th Under 21

TURKEY - Konya

8/2/2013 - 10/2/2013

Cadet Kumite Female -54 kg

Repechage Pool 1

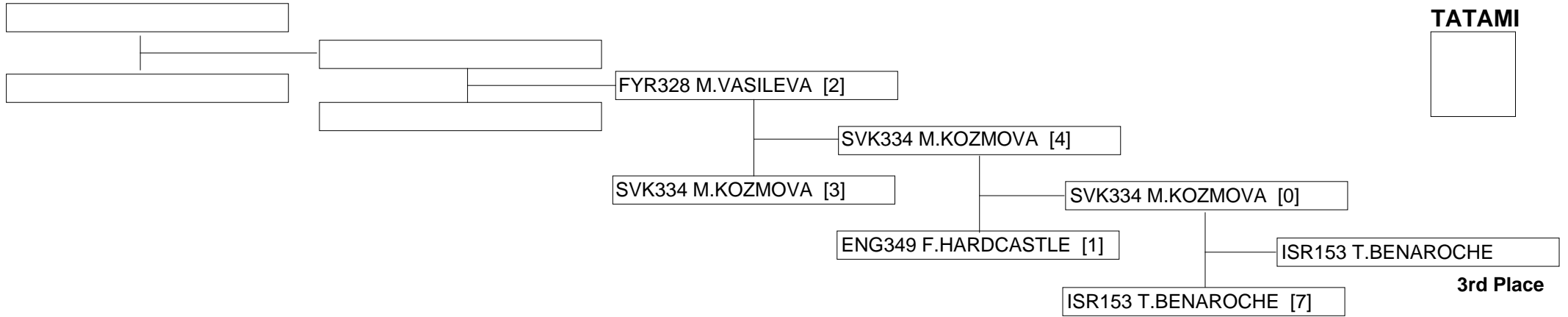

Repechage Pool 2

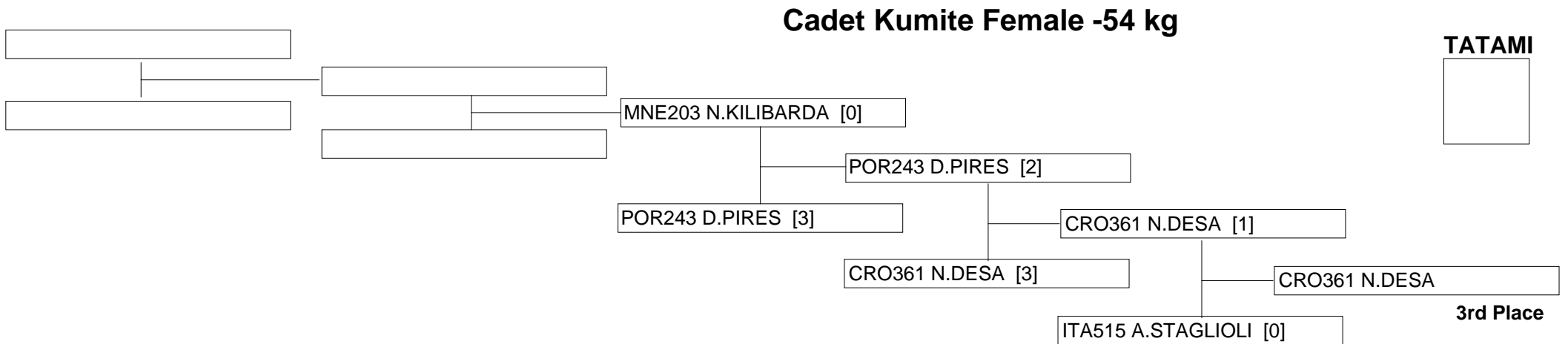



40th EKF Junior&Cadet Karate Champ. 5th Under 21

TURKEY - Konya

8/2/2013 - 10/2/2013

Cadet Kata Female

Entries: 25

- AUT259 K.WIENINGER [Annan]
- LAT217 P.MIERKALNE [Unsu]
- DEN195 F.BJERRING [Nipaipo]
- GRE308 G.XENOU [Gojushih]
- ISR171 Y.TZUR [Enpi]
- BIH304 M.BEKTAS [Gsh/Sho]
- SCO205 C.PENMAN []
- <BYE>
- TUR634 D.ATAK [Annan]
- BLR233 H.DAUHALAVA [Anna]
- FYR330 M.DIMOSKA []
- <BYE>
- SVK339 D.PESKOVA [Kur/nfa]
- SRB418 V.GAJINOVIC [Enpi]
- ENG313 K.MUNNS CHARLTO
- <BYE>
- CRO344 P.BOZIC [Seipai]
- RUS636 A.RUMIANTCEVA [Gs]
- EST195 K.KOPPEL []
- <BYE>
- FRA526 N.GOZE [Enpi]
- GER516 M.RICHTER [Sup/mp]
- POR237 M.CORREIA []
- <BYE>
- MNE220 S.JOVANOVIC [Gsh/]
- SLO282 M.SIMONIC [Jiin]
- UKR312 O.KHALLYYEVA []
- <BYE>
- SWE208 L.WAGLUND [Sei/chi]
- FIN192 N.HANIAN [Kank Dai]
- ITA506 S.SASSANO []
- <BYE>





40th EKF Junior&Cadet Karate Champ. 5th Under 21

TURKEY - Konya

8/2/2013 - 10/2/2013

Cadet Kata Female

Repechage Pool 1

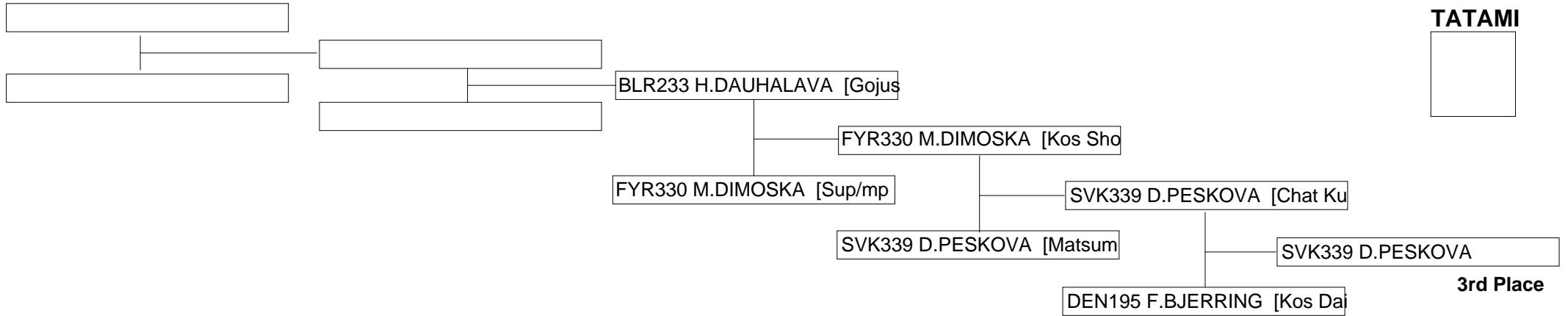

Repechage Pool 2

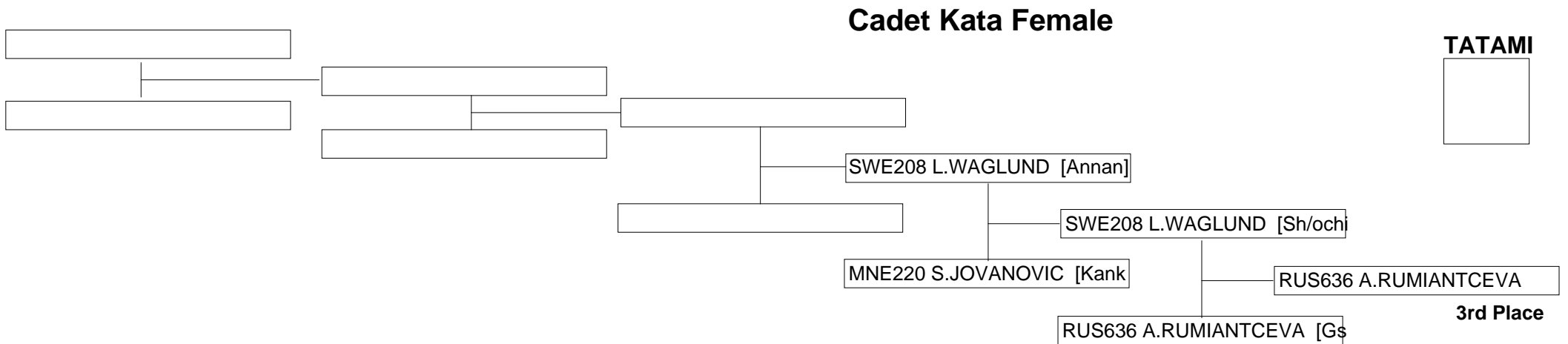



40th EKF Junior&Cadet Karate Champ. 5th Under 21

TURKEY - Konya

8/2/2013 - 10/2/2013

Cadet Kata Male

Entries: 30

- AZE275 R.HEYDAROV [Kank
- POR241 D.FERNANDES [Bas
- CRO375 M.SENJUG [Annan]
- SWE207 K.TRUONG [Seipai]
- BLR238 K.OSTROVSKI [Annan]
- SVK331 D.JANKECH [Heiku]
- SRB271 J.SIMIC [Gsh/Sho]
- BEL224 A.DAVOINE [Kank Dai]
- GER391 R.LUX [Gsh/Sho]
- ITA516 F.ZACCONE [Chat Kus]
- DEN198 L.EKKERT [Nipaipo]
- FRA533 S.MORASSI [Kank Dai]
- HUN228 P.MIHALY [Seipai]
- MNE201 B.ZECEVIC [Enpi]
- LAT221 E.GRANOVSKIS []
- <BYE>
- SLO274 E.MUJDZIC []
- AND134 S.MOREIRA []
- BIH282 E.TIHAK []
- AUT230 J.STRUGER []
- GRE379 M.PAPADOPETRAKIS
- ENG323 K.NUNKOO [Annan]
- RUS503 V.KOBZAREV [Enpi]
- SCO214 C.SCOTT [Chat Kus]
- CZE240 L.VIK [Jion]
- SUI266 M.ROESCH [Enpi]
- BUL263 M.DINEV [Seipai]
- FYR320 F.ISIC [Gsh/Sho]
- TUR744 F.KARABAG [Sup/mp
- ESP528 C.FORNELL ARIAS [C
- UKR319 M.TIUKH []
- <BYE>

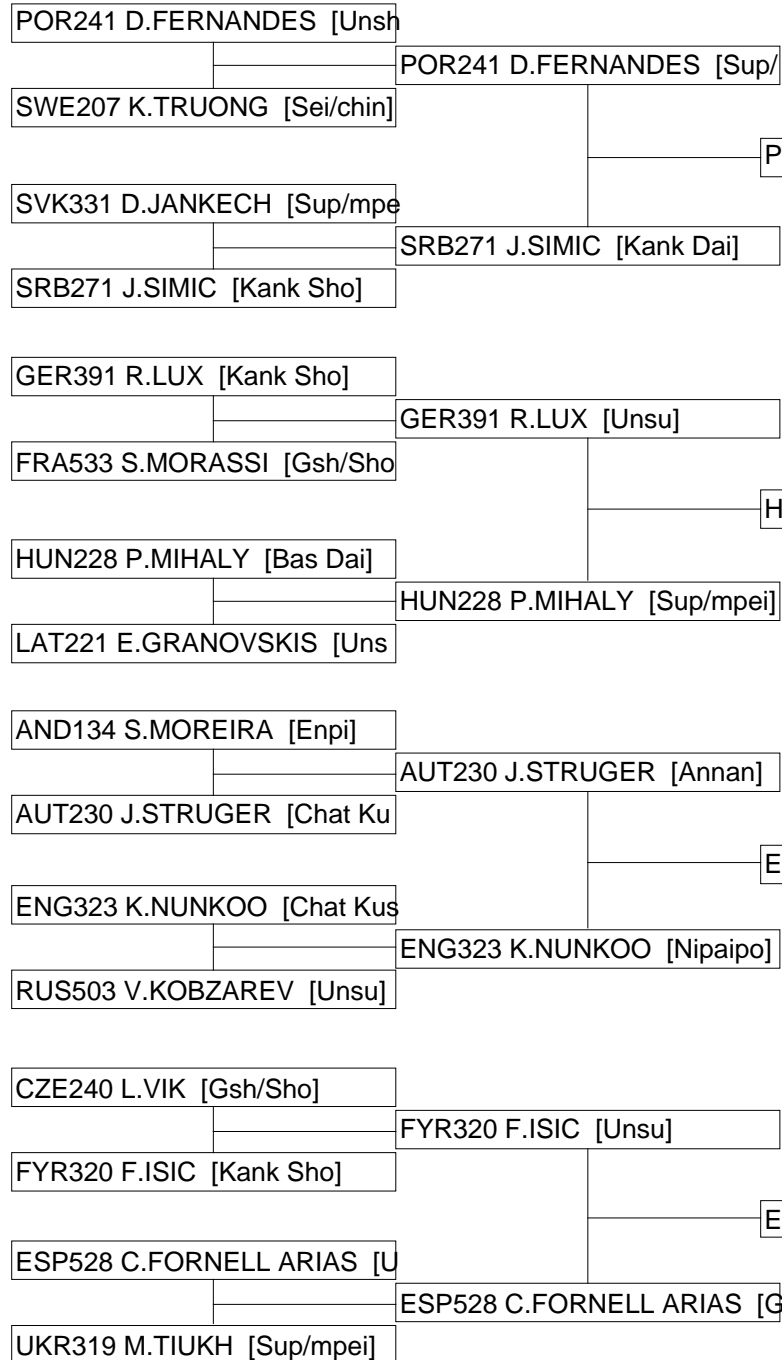

Pool 1

TATAMI

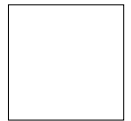

TATAMI

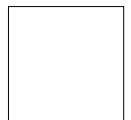

Pool 2

Cadet Kata Male



40th EKF Junior&Cadet Karate Champ. 5th Under 21

TURKEY - Konya

8/2/2013 - 10/2/2013

Cadet Kata Male

Repechage Pool 1

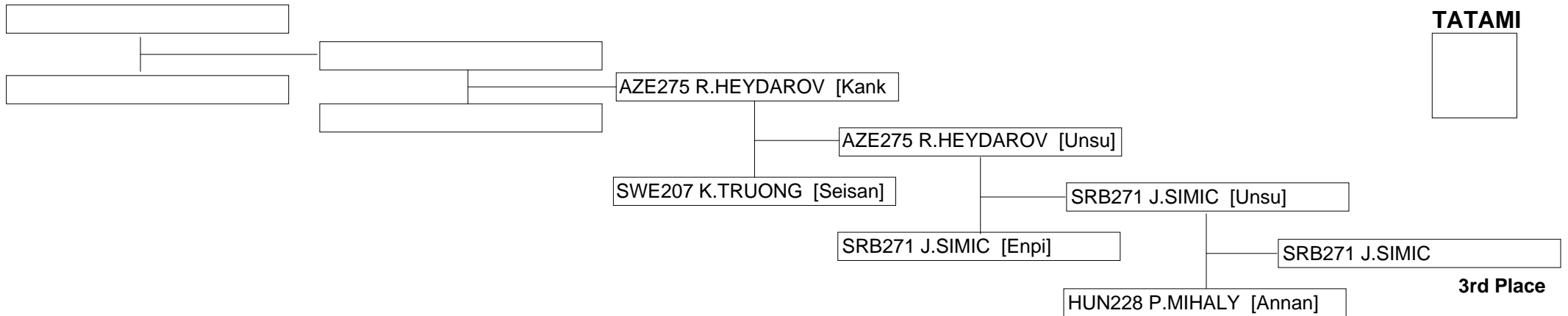

Repechage Pool 2

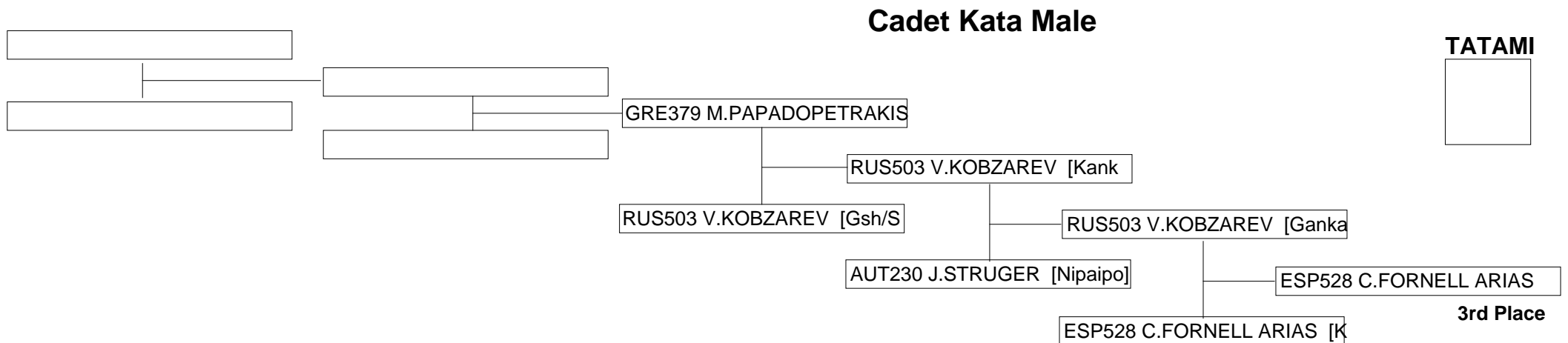



40th EKF Junior&Cadet Karate Champ. 5th Under 21

TURKEY - Konya

8/2/2013 - 10/2/2013

Cadet Kumite Male 70+ kg

Entries: 24

MNE227 K.VUJOSEVIC [0]
CRO358 J.BUNJEVAC [1]
FYR458 B.MISINI []
<BYE>

CRO358 J.BUNJEVAC [2]
FYR458 B.MISINI [0]

CRO358 J.BUNJEVAC []

CRO358 J.BUNJEVAC [3]

UKR309 D.BARANETSKYY [1]
LAT224 A.MELBERGS [0]
SRB420 B.OBRADOVIC []
<BYE>

UKR309 D.BARANETSKYY [6]
SRB420 B.OBRADOVIC [0]

UKR309 D.BARANETSKYY []

CRO358 J.BUNJEVAC [4]

BLR237 K.STARAVOIT [6]
EST193 S.KANARBIK [2]
LUX155 J.ROOB []
<BYE>

BLR237 K.STARAVOIT [3]
LUX155 J.ROOB [4]

LUX155 J.ROOB [0]

DEN204 A.FRITHIOFF [1]

FRA524 M.BOULARES [9]
GER507 W.TERENGIN [5]
DEN204 A.FRITHIOFF []
<BYE>

FRA524 M.BOULARES [0]
DEN204 A.FRITHIOFF [2]

DEN204 A.FRITHIOFF [6]

TUR748 O.USTUN

HUN265 E.CSATO [8]
ISR157 R.AMOSSI [0]
POR247 M.RIBEIRO []
<BYE>

HUN265 E.CSATO [3]
POR247 M.RIBEIRO [0]

HUN265 E.CSATO [0]

TUR748 O.USTUN [7]

AZE270 V.VALIYEV [8]
GRE476 N.BOGIANNIDIS [0]
TUR748 O.USTUN []
<BYE>

AZE270 V.VALIYEV [0]
TUR748 O.USTUN [3]

TUR748 O.USTUN [8]

TUR748 O.USTUN [5]

BIH281 A.VATRIC [1]
RUS564 I.IVANCHIKHIN [5]
SVK309 D.KOSTOLNIK []
<BYE>

RUS564 I.IVANCHIKHIN [8]
SVK309 D.KOSTOLNIK [0]

RUS564 I.IVANCHIKHIN [4]

RUS564 I.IVANCHIKHIN [3]

SLO276 A.FILIC [0]
SWE197 S.BRAJIC [2]
ESP527 M.MARTINEZ VELILLA
<BYE>

SWE197 S.BRAJIC [1]
ESP527 M.MARTINEZ VELILLA

ESP527 M.MARTINEZ VELILLA

Cadet Kumite Male 70+ kg

Pool 1

TATAMI

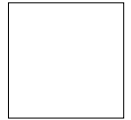

TATAMI

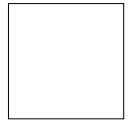

Pool 2



40th EKF Junior&Cadet Karate Champ. 5th Under 21

TURKEY - Konya

8/2/2013 - 10/2/2013

Cadet Kumite Male 70+ kg

Repechage Pool 1

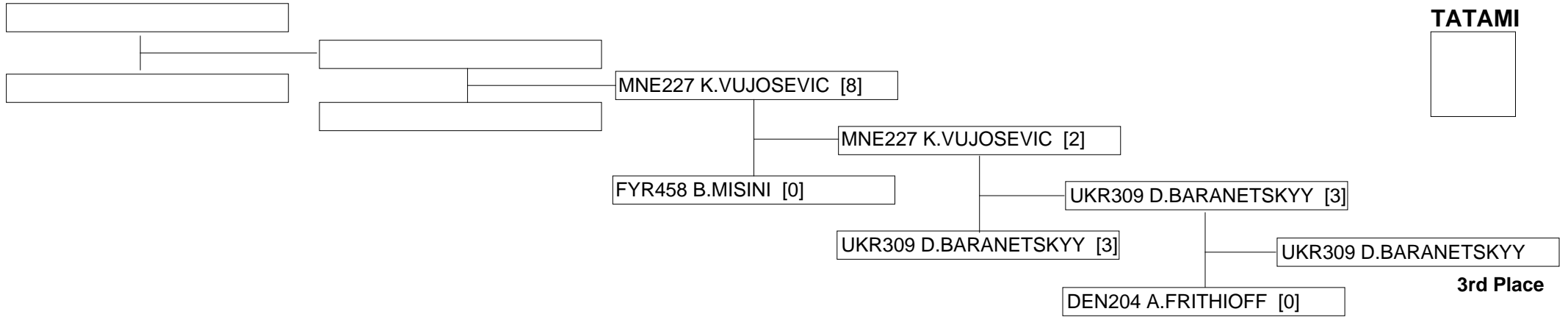

Repechage Pool 2

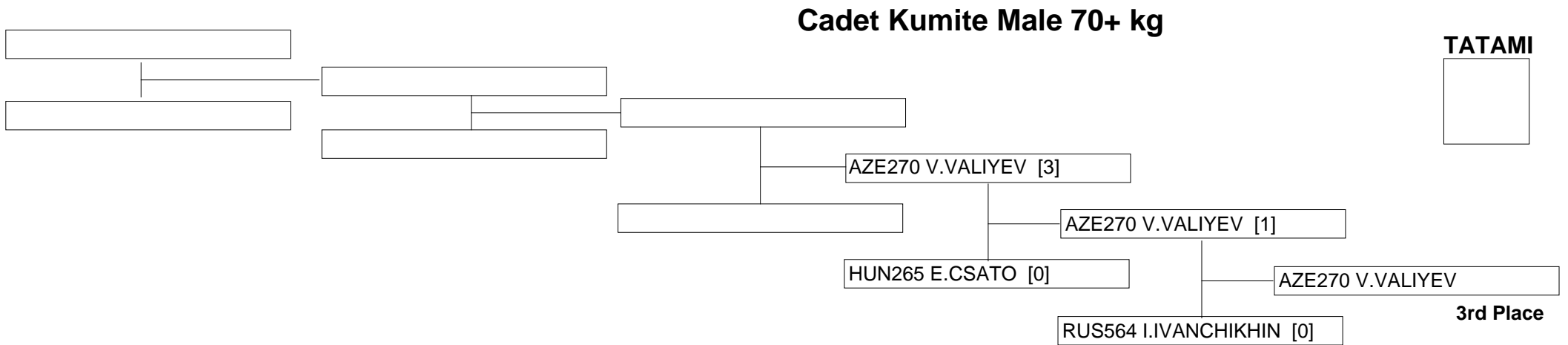



40th EKF Junior&Cadet Karate Champ. 5th Under 21

TURKEY - Konya

8/2/2013 - 10/2/2013

Cadet Kumite Male -52 kg

Entries: 27

SUI270 N.PISINO [0]
ENG352 C.PARRIS [3]
TUR632 E.SAMDAN [8]
BLR236 A.KURAYEDAU [0]
BUL263 M.DINEV [0]
LUX157 P.BIBERICH [5]
BIH450 G.HRKAC []
<BYE>
EST202 D.RODIONOV [7]
POR241 D.FERNANDES [4]
GRE398 A.KOTTIAS DIMKOPO
AZE274 U.GURBANOV [3]
SVK332 D.IMRICH [5]
LAT226 R.REINHAUSS [0]
UKR315 D.LYVYTSKYI []
<BYE>
SLO272 A.SUSIC [3]
FRA535 I.MARDHI [2]
RUS635 D.OSMAGOV [3]
GER511 D.KUHN [1]
SWE196 D.BARKELIND [0]
MNE342 N.DULOVIC [8]
HUN280 D.HUBNER []
<BYE>
CRO362 A.HOVAN [0]
BEL225 J.ROSIELLO [0]
FYR308 S.KOSTIK []
<BYE>
ROM220 V.PAMFIL [0]
SRB424 V.PUCAR [2]
SCO210 J.COULTER []
<BYE>

ENG352 C.PARRIS [0]
TUR632 E.SAMDAN [3]
TUR632 E.SAMDAN [1]
LUX157 P.BIBERICH [0]
BIH450 G.HRKAC [0]
BIH450 G.HRKAC [1]
EST202 D.RODIONOV []
AZE274 U.GURBANOV [3]
AZE274 U.GURBANOV []
SVK332 D.IMRICH [2]
SVK332 D.IMRICH [2]
UKR315 D.LYVYTSKYI [0]
SLO272 A.SUSIC [3]
SLO272 A.SUSIC [2]
RUS635 D.OSMAGOV [0]
MNE342 N.DULOVIC [0]
HUN280 D.HUBNER [1]
HUN280 D.HUBNER [2]
BEL225 J.ROSIELLO [0]
FYR308 S.KOSTIK [0]
FYR308 S.KOSTIK [8]
SRB424 V.PUCAR [0]
SCO210 J.COULTER [8]
SCO210 J.COULTER [8]

TUR632 E.SAMDAN [4]
BIH450 G.HRKAC [0]
AZE274 U.GURBANOV [3]
AZE274 U.GURBANOV [0]
SVK332 D.IMRICH [2]
SLO272 A.SUSIC [0]
HUN280 D.HUBNER [1]
FYR308 S.KOSTIK [0]
SCO210 J.COULTER [2]
SCO210 J.COULTER [8]

TUR632 E.SAMDAN [7]
TUR632 E.SAMDAN
SCO210 J.COULTER [0]
SCO210 J.COULTER [2]

Pool 1

TATAMI

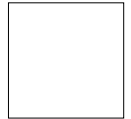

TATAMI

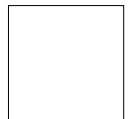

Pool 2

Cadet Kumite Male -52 kg



40th EKF Junior&Cadet Karate Champ. 5th Under 21

TURKEY - Konya

8/2/2013 - 10/2/2013

Cadet Kumite Male -52 kg

Repechage Pool 1

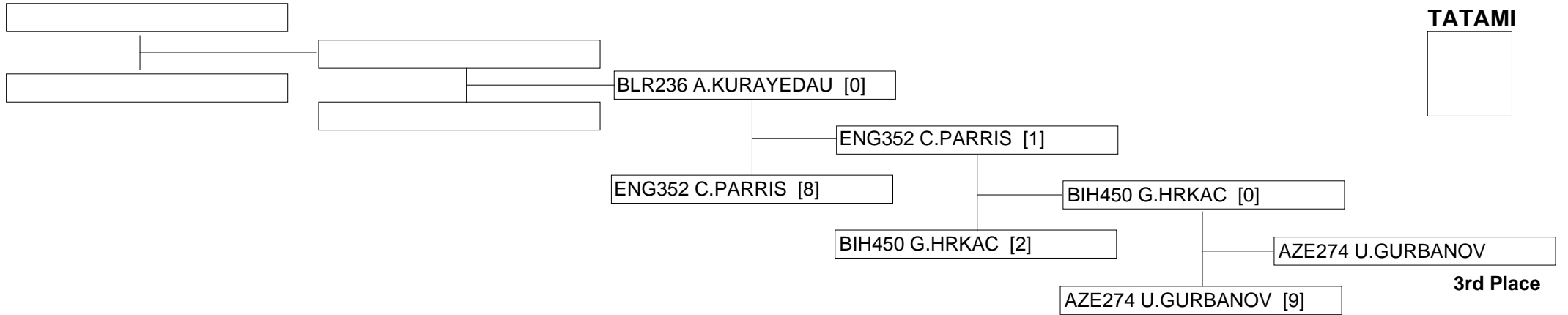

Repechage Pool 2

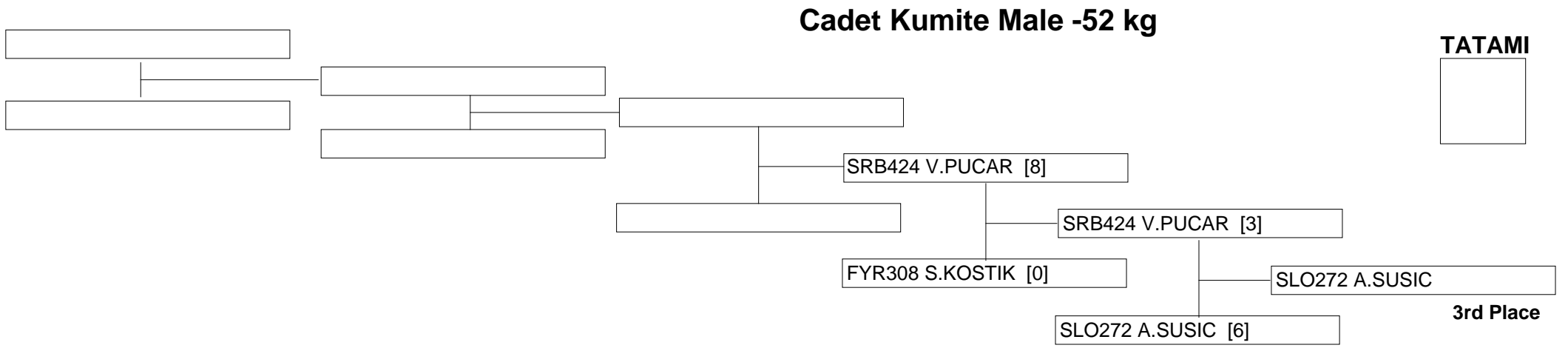



40th EKF Junior&Cadet Karate Champ. 5th Under 21

TURKEY - Konya

8/2/2013 - 10/2/2013

Cadet Kumite Male -57 kg

Entries: 21

SWE205 I.SUNDQUIST [3]
SVK336 R.KOREN [1]
SRB296 F.STOJAN []
<BYE>
HUN254 B.ARDAL [1]
GRE480 T.KANELLIDIS [3]
FRA525 M.COPPIN []
<BYE>
GER512 M.PFLAUM [3]
ROM265 M.BALTARETU [0]
MNE205 M.HODZIC []
<BYE>
UKR316 I.YAMBURENKO []
<BYE>
TUR745 A.KORKMAZ []
<BYE>
CRO360 K.BRKIC [2]
BIH310 M.BRKIC [4]
FYR430 S.APOSTOLOVSKI []
<BYE>
SCO211 J.GILMOUR []
<BYE>
RUS632 R.GAMMADOV []
<BYE>
POR242 B.FREITAS [7]
SLO278 T.KAJTNA [0]
AZE258 J.GANIYEV []
<BYE>
ENG351 B.PARRIS []
<BYE>
ESP558 S.ENNKHAILI ANQOU
<BYE>

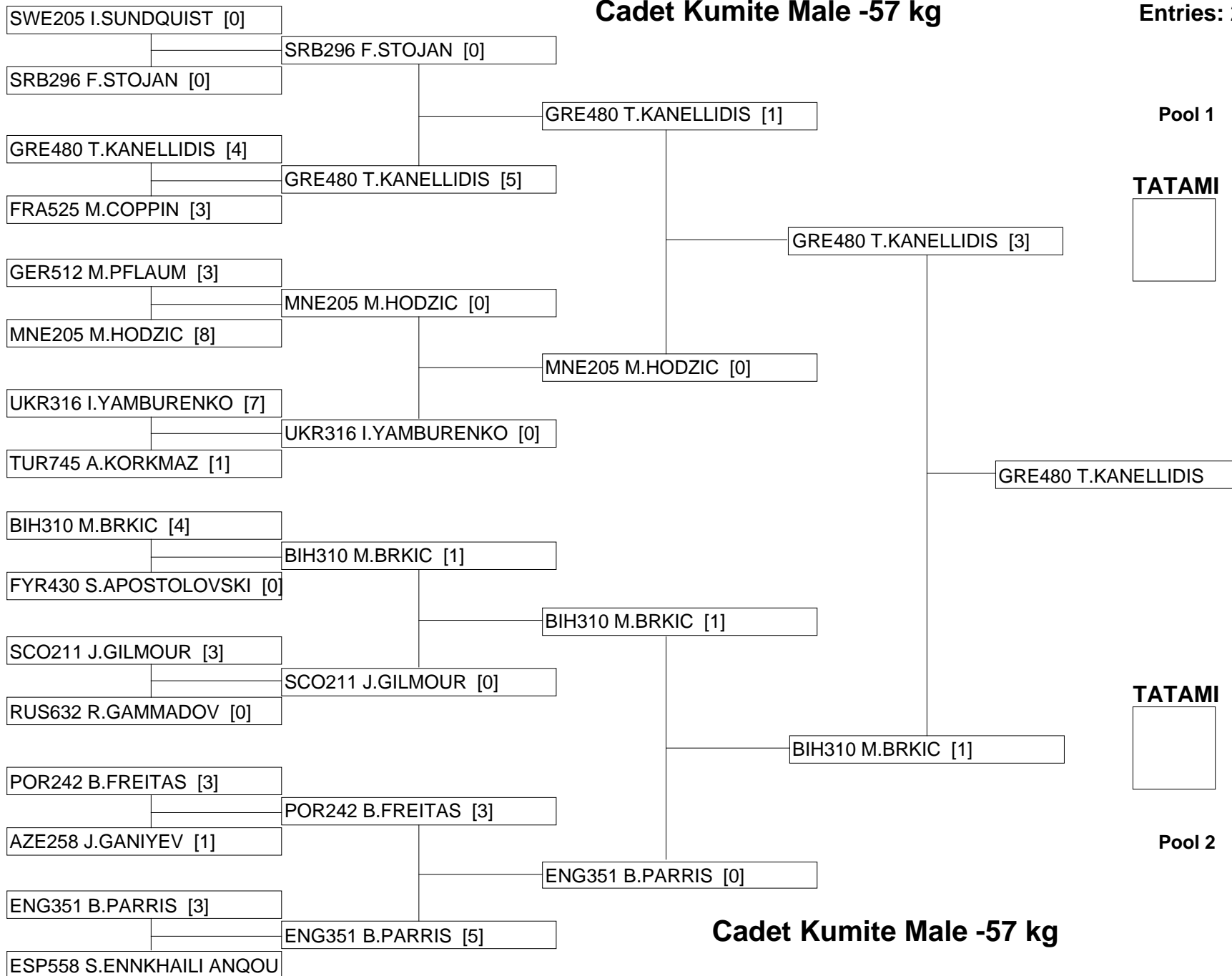



40th EKF Junior&Cadet Karate Champ. 5th Under 21

TURKEY - Konya

8/2/2013 - 10/2/2013

Cadet Kumite Male -57 kg

Repechage Pool 1

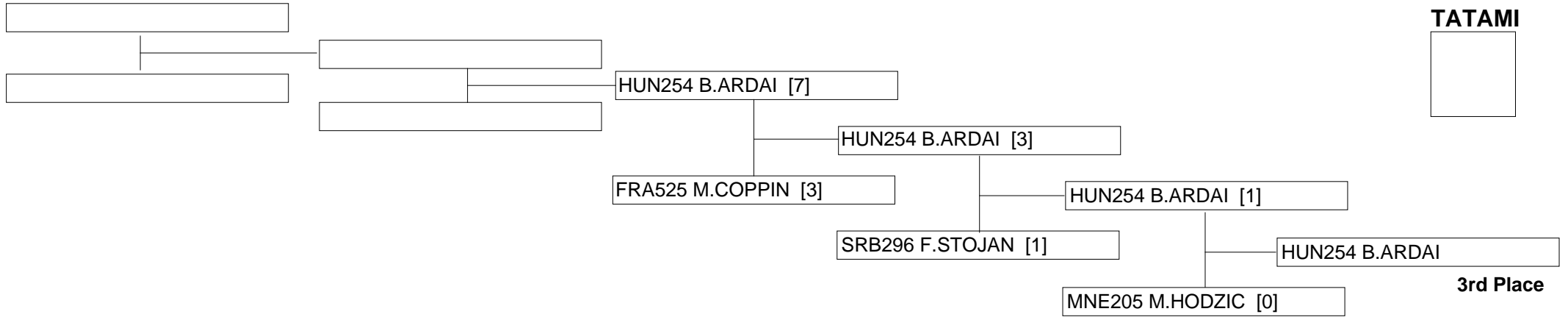

Repechage Pool 2

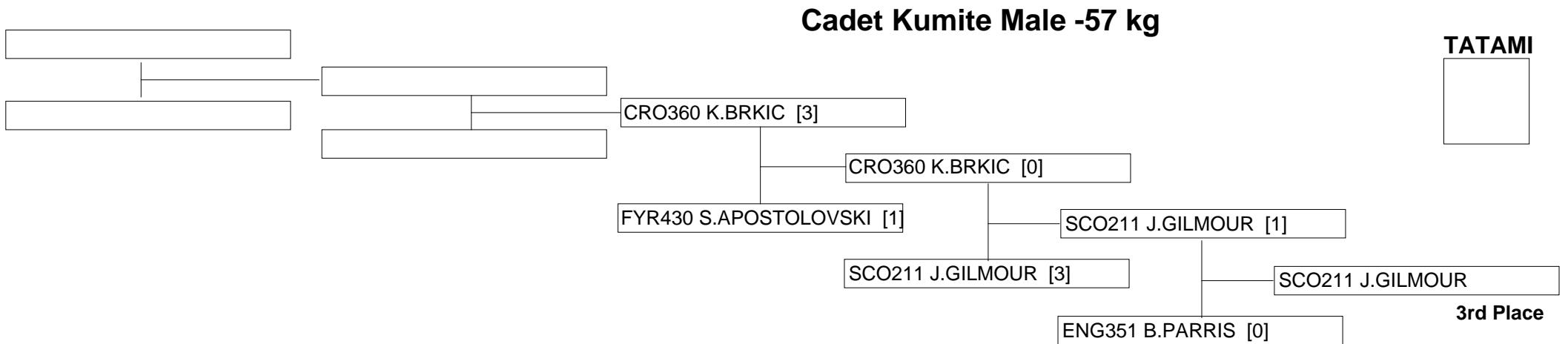



40th EKF Junior&Cadet Karate Champ. 5th Under 21

TURKEY - Konya

8/2/2013 - 10/2/2013

Cadet Kumite Male -63 kg

Entries: 26

EST196 A.ZEINALOV [1]
UKR314 D.KUBYSHKIN [5]
BIH303 V.CAPIN [3]
ITA517 D.SIMMI [1]
BUL283 V.KOLESHANSKI [0]
GER508 M.BAUER [5]
NIR112 C.RYAN []
<BYE>
TUR680 A.TAYLAN [5]
HUN279 F.TAMAS [0]
DEN194 J.ANDERSEN []
<BYE>
LAT220 V.AKSTINS [0]
POR249 A.SOUSA [3]
AZE264 H.ALIYEV []
<BYE>
SVK329 L.DZACOVSKY [0]
ROM268 A.IORDACHE [2]
MNE237 S.MEDENICA [1]
ENG335 M.PRIESTLEY [3]
GRE443 V.GIAKOUMIDIS [8]
RUS593 K.SOLOPOV [0]
SRB261 S.DJORDJE []
<BYE>
NOR174 P.LARSEN [0]
SUI265 K.KABASHI [3]
CRO369 S.STIMAC []
<BYE>
FRA530 A.RASPILAIR [4]
FIN198 L.NURMI [0]
FYR340 D.OSMANI []
<BYE>

UKR314 D.KUBYSHKIN [3]
BIH303 V.CAPIN [0]
BIH303 V.CAPIN [4]
GER508 M.BAUER [7]
GER508 M.BAUER [2]
NIR112 C.RYAN [0]
TUR680 A.TAYLAN [1]
TUR680 A.TAYLAN [8]
DEN194 J.ANDERSEN [1]
TUR680 A.TAYLAN [0]
POR249 A.SOUSA [0]
POR249 A.SOUSA [0]
AZE264 H.ALIYEV [4]
ROM268 A.IORDACHE [0]
ENG335 M.PRIESTLEY [0]
ENG335 M.PRIESTLEY [8]
GRE443 V.GIAKOUMIDIS [0]
SRB261 S.DJORDJE [1]
SRB261 S.DJORDJE [8]
SUI265 K.KABASHI [0]
CRO369 S.STIMAC [0]
CRO369 S.STIMAC [8]
FRA530 A.RASPILAIR [1]
FRA530 A.RASPILAIR [1]
FYR340 D.OSMANI [0]

GER508 M.BAUER [8]

GER508 M.BAUER [1]

GER508 M.BAUER

SRB261 S.DJORDJE [1]

SRB261 S.DJORDJE [0]

FRA530 A.RASPILAIR [0]

Pool 1

TATAMI

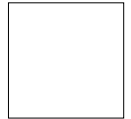

TATAMI

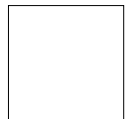

Pool 2

Cadet Kumite Male -63 kg



40th EKF Junior&Cadet Karate Champ. 5th Under 21

TURKEY - Konya

8/2/2013 - 10/2/2013

Cadet Kumite Male -63 kg

Repechage Pool 1

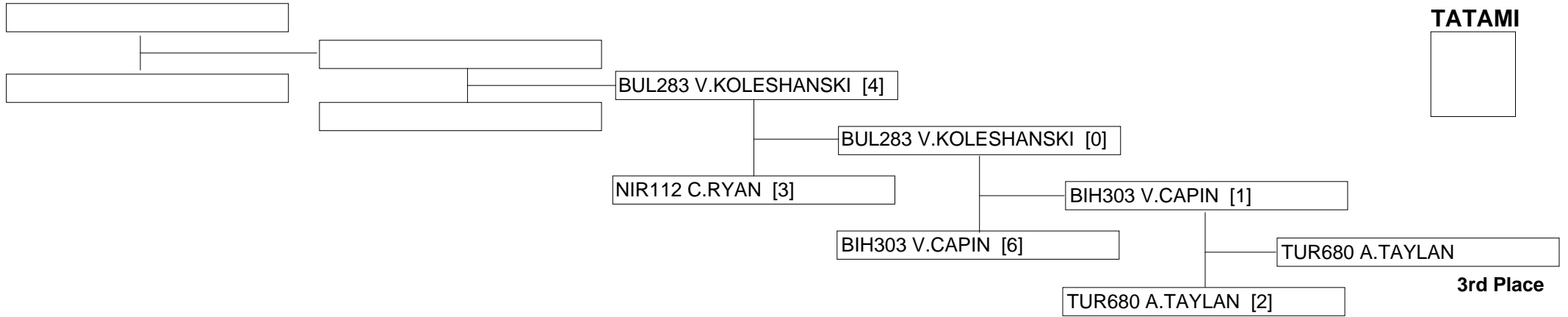

Repechage Pool 2

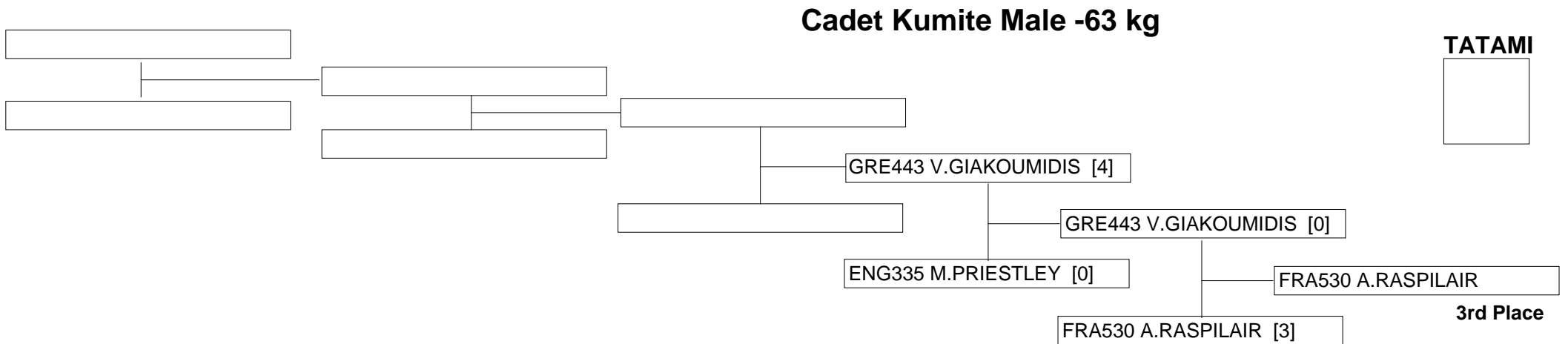



40th EKF Junior&Cadet Karate Champ. 5th Under 21

TURKEY - Konya

8/2/2013 - 10/2/2013

Cadet Kumite Male -70 kg

Entries: 30

BIH448 V.BRKIC [3]
ITA512 A.DE STEFANO [0]
UKR318 A.POTAPTSEV [0]
AUT252 A.GRATZER [2]
GRE433 K.KIRLOGLOU [1]
CRO363 A.GREDENIC [0]
FIN189 J.HELIN [6]
BLR235 A.KURHAN [2]
LAT227 D.SADIKOV [0]
FYR276 A.MEHMED [4]
ROM264 B.ALEXE [4]
CYR195 M.STYLIANOU [0]
WAL152 T.OLEARY [0]
BUL272 G.BRAYKOV [2]
SUI269 J.SHANE []
<BYE>
RUS637 M.SACHKOV [3]
ISR165 M.ROGOZARSKI [3]
SVK330 E.ERDESZ [8]
EST200 M.PESKOV [0]
ENG350 B.LUKE [4]
SRB406 M.MLADENOVIC [3]
SWE200 L.INGEMANSSON [1]
TUR747 S.UYGUR [3]
POR239 V.COSTA [12]
ARM154 G.SARGSYAN [3]
SCO215 K.WEIR [3]
FRA528 R.JANNIER [4]
AZE276 K.IMANOV [0]
MNE217 L.IVANOVIC [4]
GER417 P.SCHALCH []
<BYE>

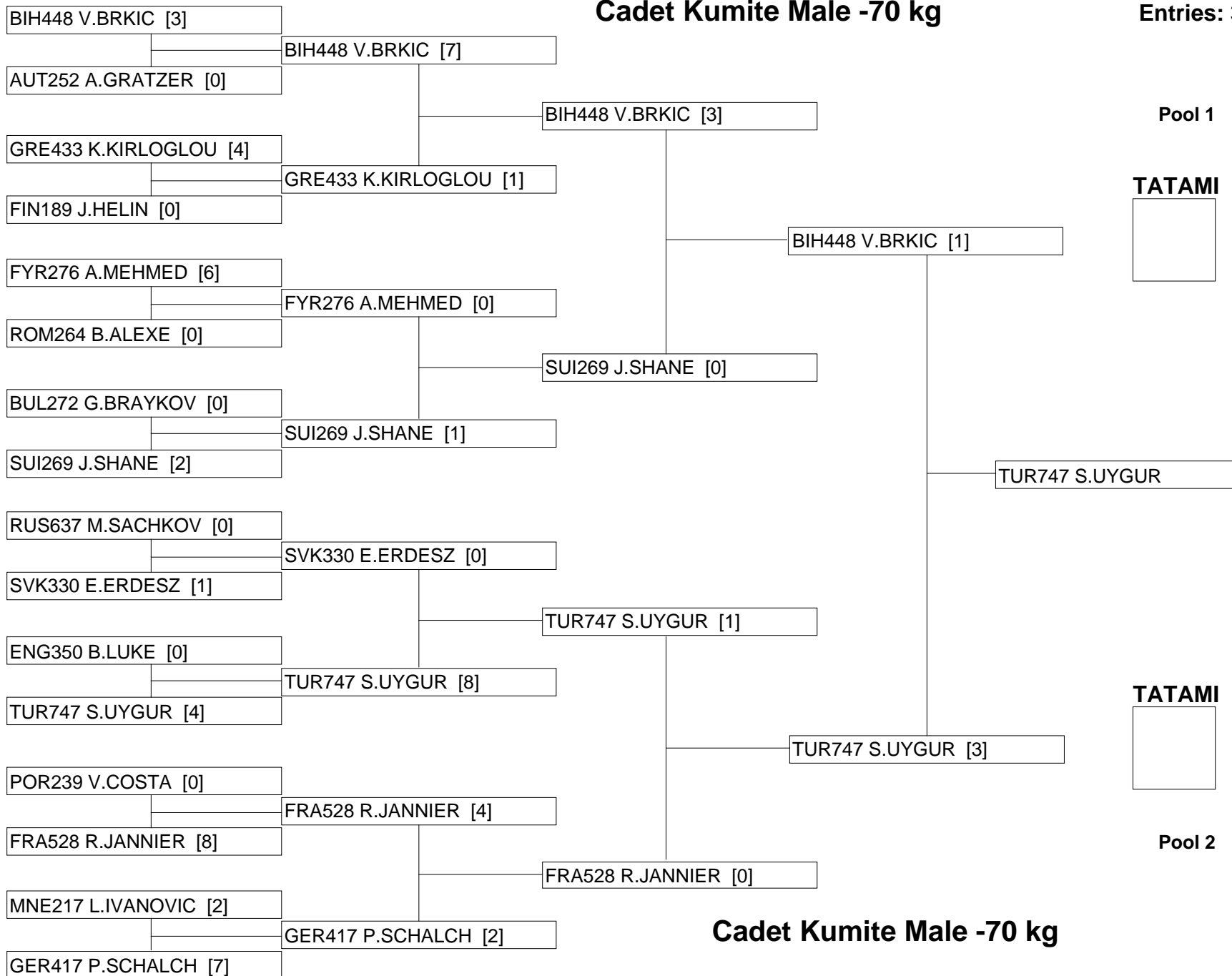



40th EKF Junior&Cadet Karate Champ. 5th Under 21

TURKEY - Konya

8/2/2013 - 10/2/2013

Cadet Kumite Male -70 kg

Repechage Pool 1

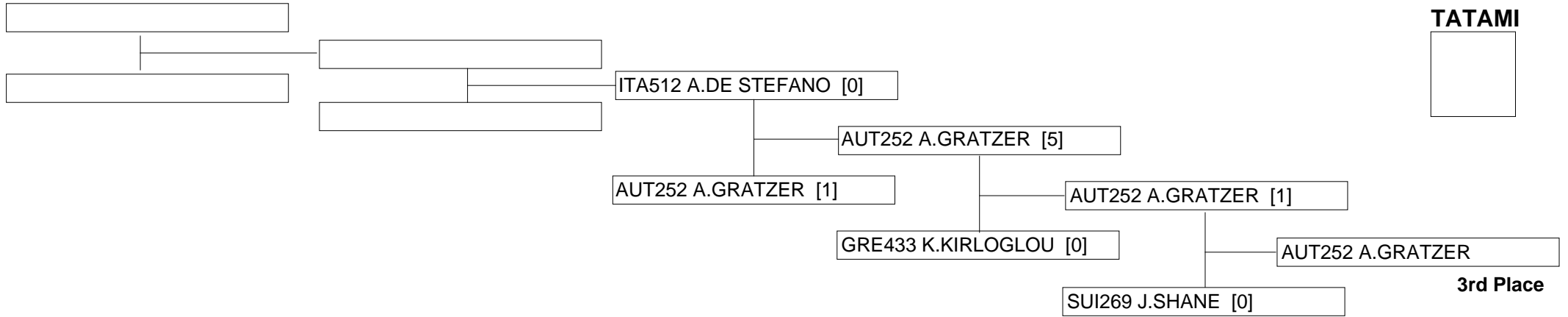

Repechage Pool 2

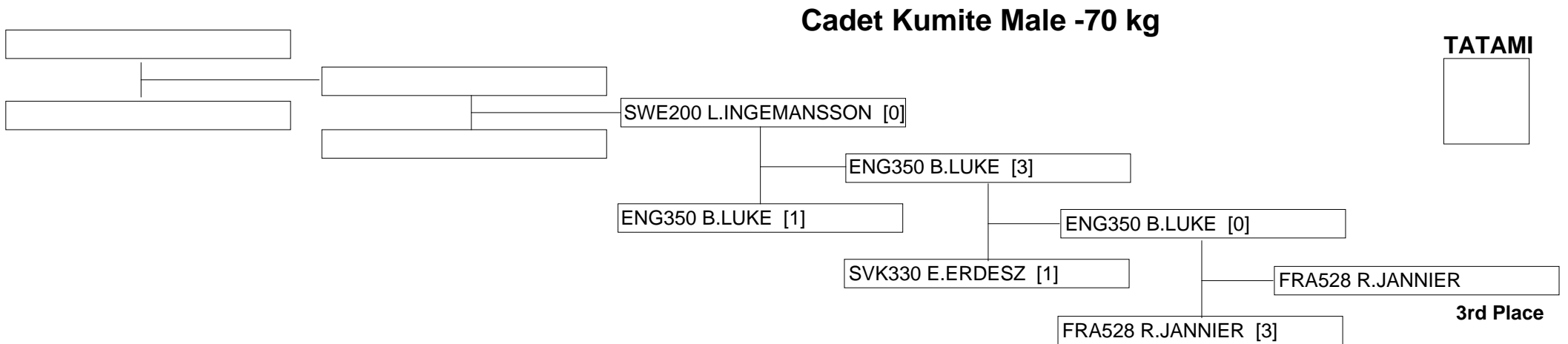



40th EKF Junior&Cadet Karate Champ. 5th Under 21

TURKEY - Konya

8/2/2013 - 10/2/2013

Under 21 Kata Female

Entries: 21

- DEN163 C.BJERRING [Annan]
- CRO290 M.KOBALÉ [Kank Dai]
- ITA334 M.DI DESIDERIO []
- <BYE>
- ENG259 E.LUCRAFT [Annan]
- FYR266 P.JOVANOSKA [Sup/
- SVK266 D.BALCIAROVA []
- <BYE>
- GRE328 E.KAVAKOPOULOU [
- POR171 P.ESPARTEIRO [Ann
- SUI259 S.MARK []
- <BYE>
- ESP435 S.GARCIA []
- <BYE>
- HUN211 Z.ANTI []
- <BYE>
- SWE185 M.KARLSSON [Anna
- RUS342 E.KOLOTENKOVA [K
- BIH236 A.ADILOVIC []
- <BYE>
- SRB200 K.PIPERIN []
- <BYE>
- LUX125 L.KINSCH []
- <BYE>
- GER289 J.BLEUL [Gsh/Sho]
- BLR231 N.HERASHCHANKA [
- TUR296 B.AKTAS []
- <BYE>
- FRA307 A.FERACCI []
- <BYE>
- CZE213 V.MISKOVA []
- <BYE>

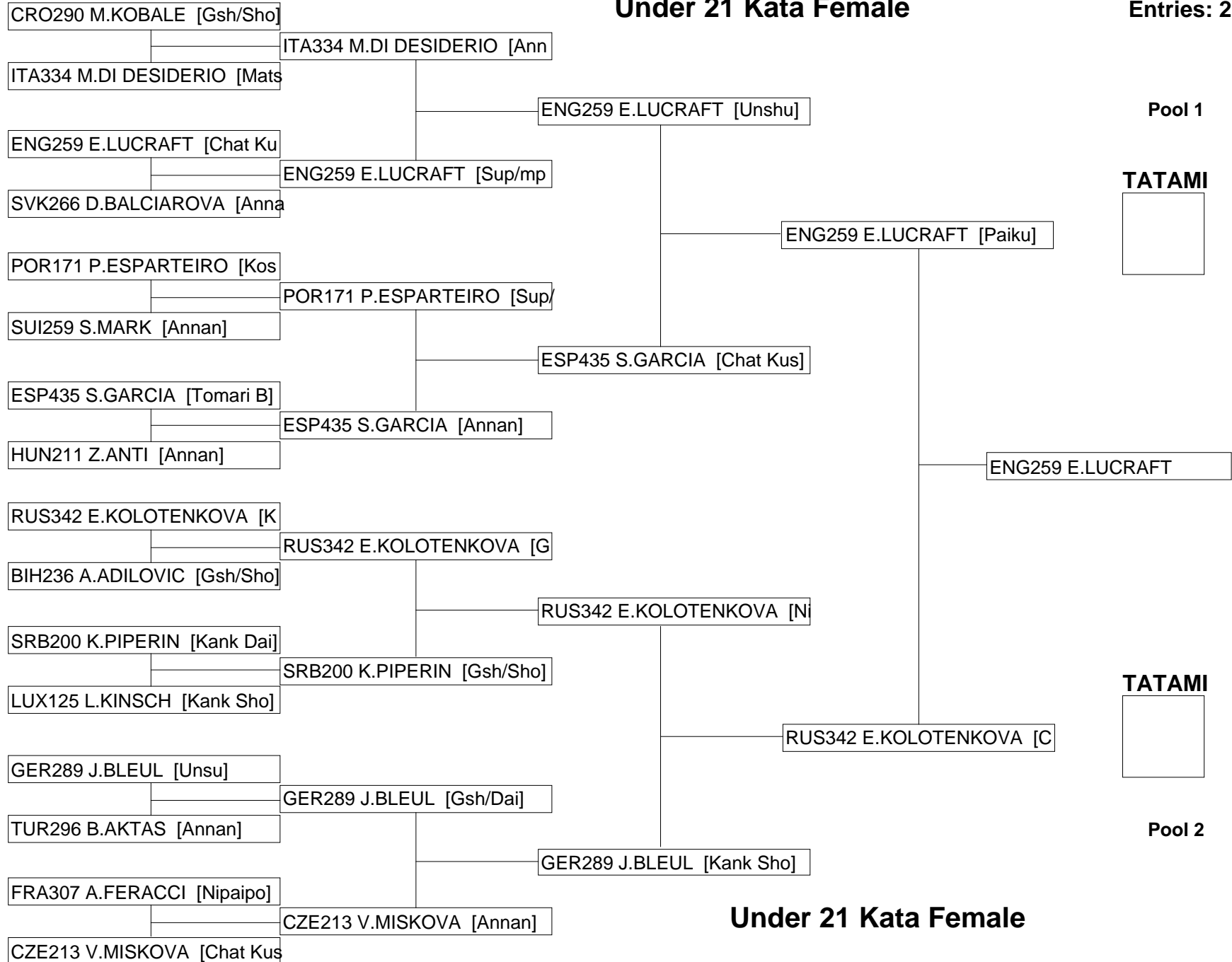

Under 21 Kata Female



40th EKF Junior&Cadet Karate Champ. 5th Under 21

TURKEY - Konya

8/2/2013 - 10/2/2013

Under 21 Kata Female

Repechage Pool 1

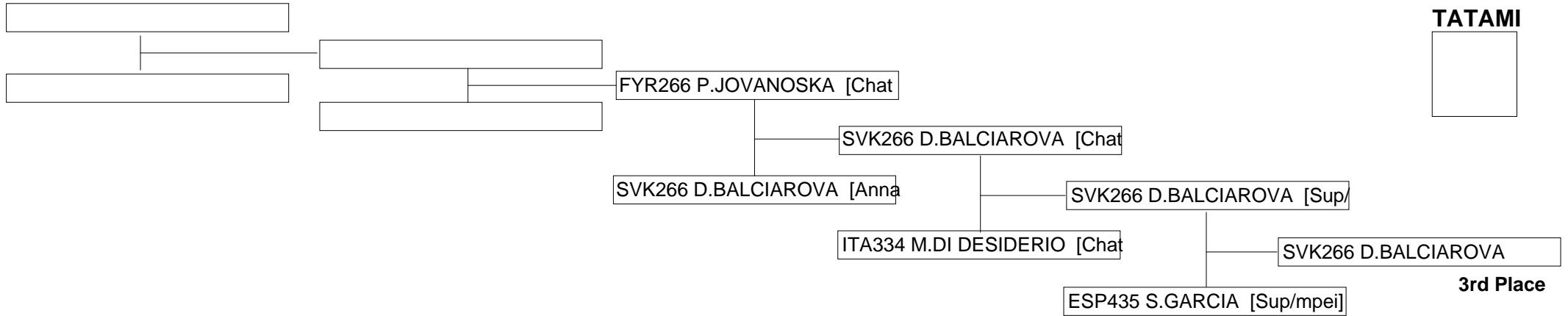

Repechage Pool 2

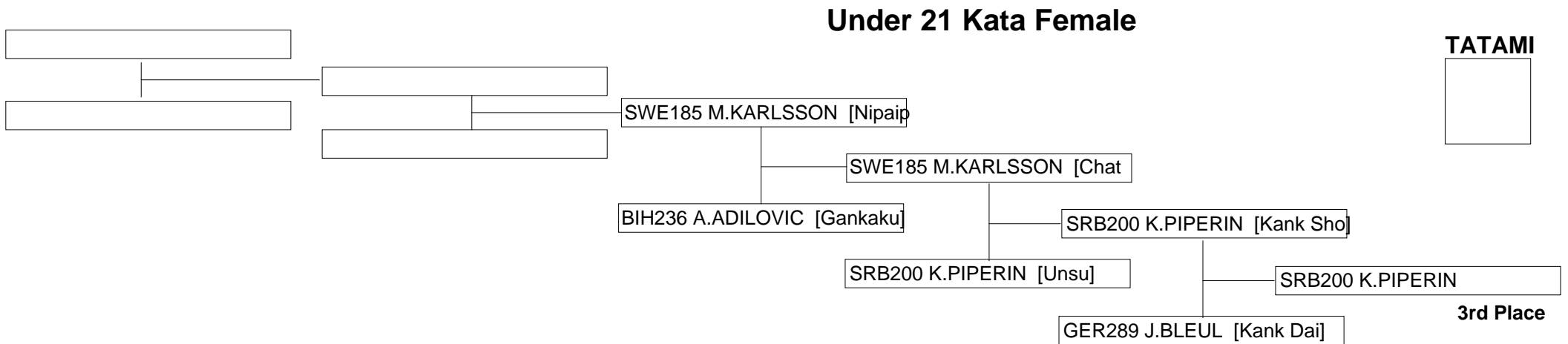



40th EKF Junior&Cadet Karate Champ. 5th Under 21

TURKEY - Konya

8/2/2013 - 10/2/2013

Junior Kumite Female 59+ kg

Entries: 26

HUN231 E.SZABO [0]
RUS412 N.ABRAMENKO [3]
AUT251 A.KORNDON [0]
SLO273 T.VRBNJAK [3]
SCO196 H.WOOD [0]
ITA377 S.SEMERARO [2]
BIH320 I.CAVAR []
<BYE>
GRE419 A.DELLI [6]
ENG297 J.POMEROY [5]
NOR173 L.ANDERSEN []
<BYE>
LAT209 V.RAZAJEVA [1]
CRO321 A.SKUNCA [0]
MNE251 S.DJURIC []
<BYE>
UKR293 O.RYABOVA [1]
SVK340 S.ORIABINCOVA [3]
IRL149 N.PERRY [1]
SRB422 N.NIKLIC [2]
FYR315 I.ATANASOVA [0]
LUX141 P.GIORGETTI [4]
SWE184 L.RASMUSSEN []
<BYE>
BUL254 E.RIZOVA [0]
TUR370 N.CICEK [5]
NED247 E.WALTZ []
<BYE>
GER510 K.KEMMET [2]
DEN173 K.PEDERSEN [0]
FRA372 N.GARCIA []
<BYE>

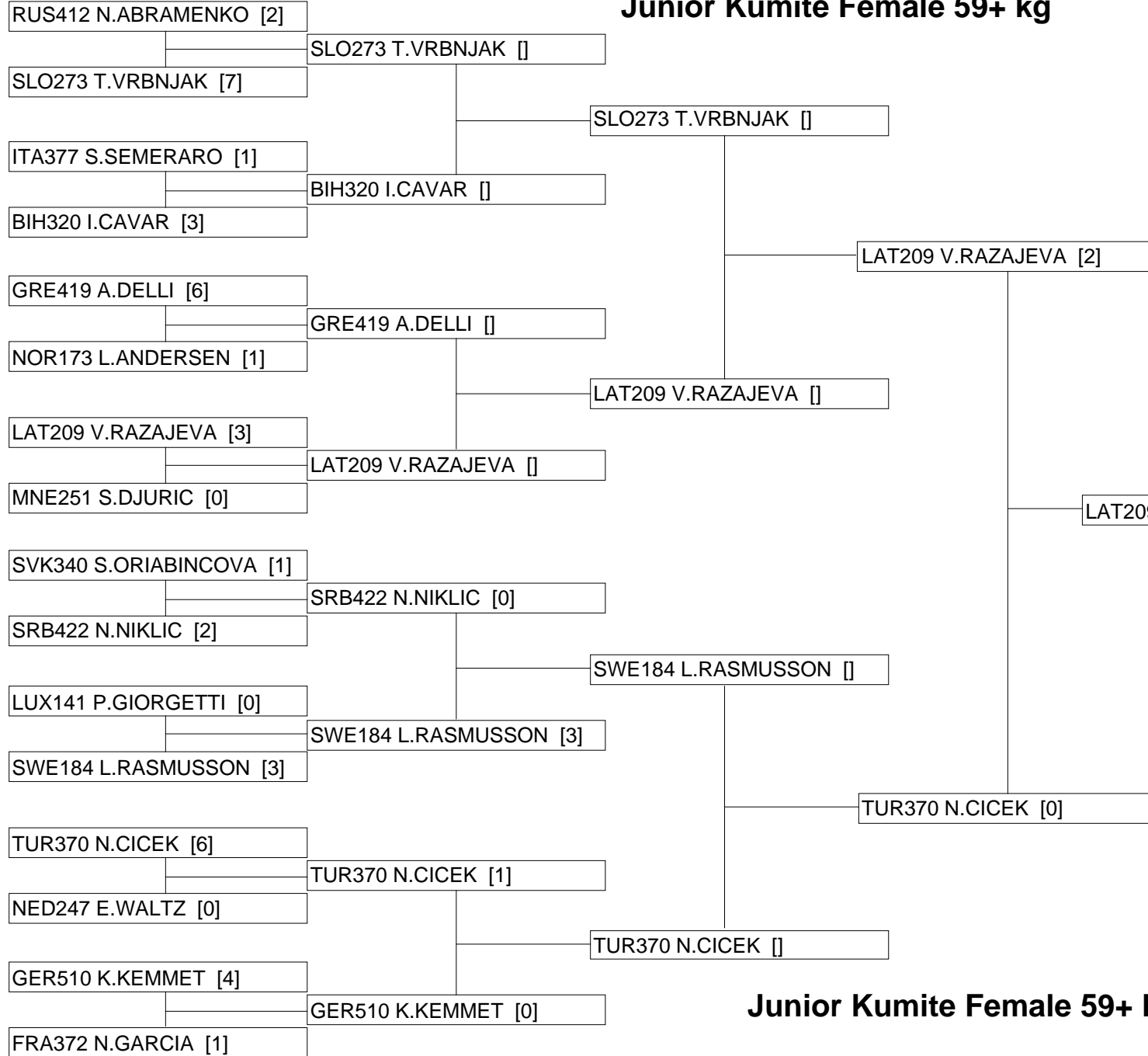

Pool 1

TATAMI

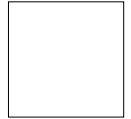

TATAMI

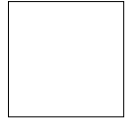

Pool 2

Junior Kumite Female 59+ kg



40th EKF Junior&Cadet Karate Champ. 5th Under 21

TURKEY - Konya

8/2/2013 - 10/2/2013

Junior Kumite Female 59+ kg

Repechage Pool 1

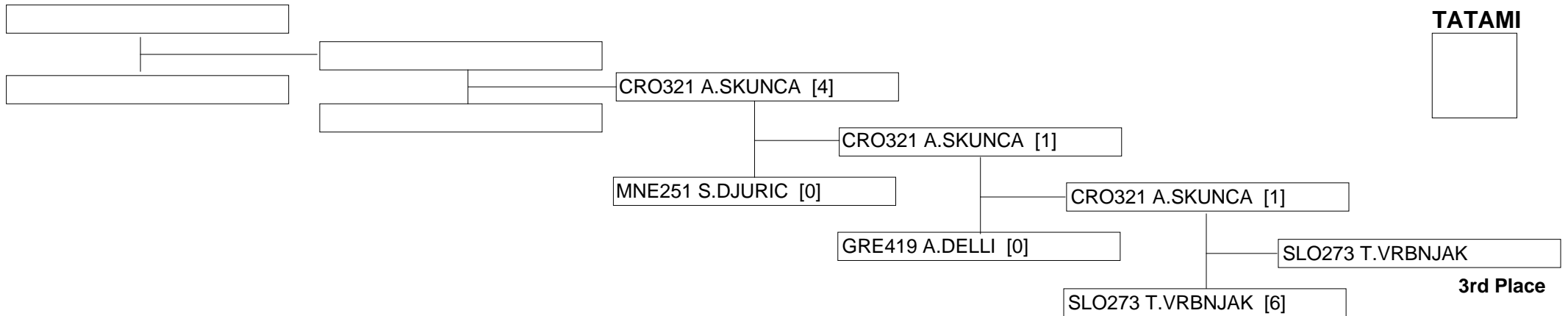

Repechage Pool 2

Junior Kumite Female 59+ kg

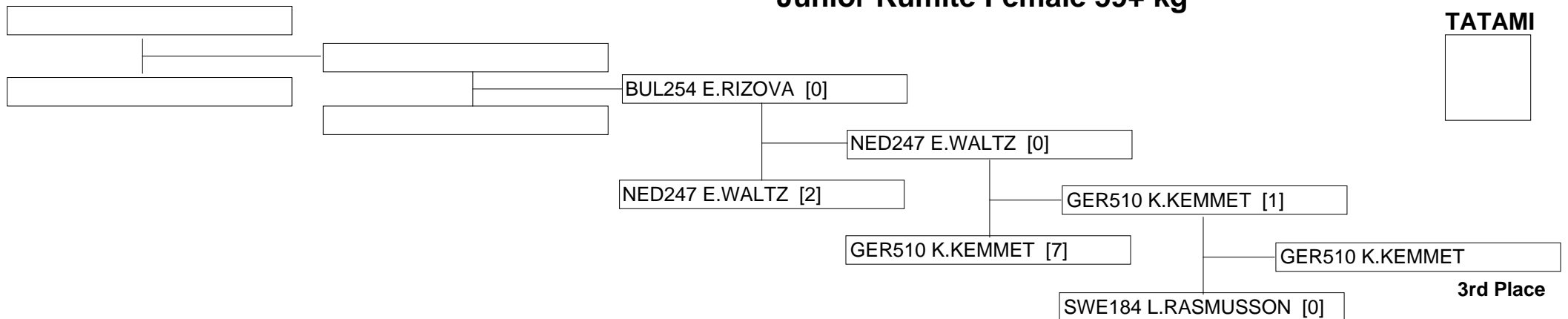



40th EKF Junior&Cadet Karate Champ. 5th Under 21

TURKEY - Konya

8/2/2013 - 10/2/2013

Junior Kumite Female -48 kg

Entries: 22

MNE207 D.MILJANIC [5]
FIN195 R.KIVINIEMI [1]
ISR156 C.AMOS []
<BYE>
HUN210 L.VAJDA [4]
SRB423 D.NEGOVANOVIC [8]
BIH449 M.DELIC []
<BYE>
SLO238 D.CATAKOVIC [4]
SVK335 V.KADLECIKOVA [1]
GRE404 D.KARIPIDOU []
<BYE>
ITA376 E.PERFETTO []
<BYE>
GER505 L.NEUMANN []
<BYE>
ESP445 G.MORALES [3]
CYR183 S.ZENIOS [0]
TUR552 S.AKKURT []
<BYE>
FRA330 S.BOUDERBANE [2]
NED210 Y.KUYPER [0]
RUS631 M.BOROZDINA []
<BYE>
POR221 J.ALMEIDA [0]
ENG301 L.TUTTY [3]
FYR459 A.TOSHEVSKA []
<BYE>
CRO357 M.BERULEC []
<BYE>
SUI248 F.WABER []
<BYE>





40th EKF Junior&Cadet Karate Champ. 5th Under 21

TURKEY - Konya

8/2/2013 - 10/2/2013

Junior Kumite Female -48 kg

Repechage Pool 1

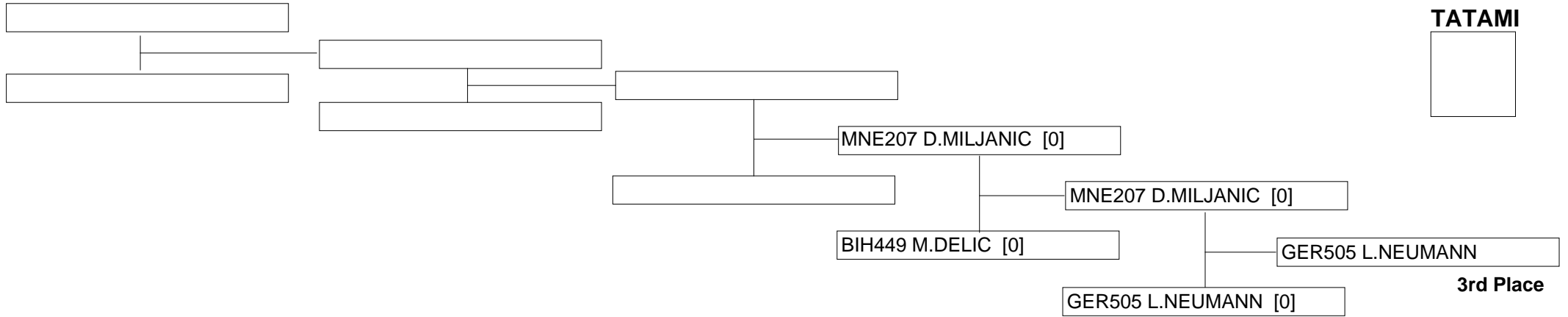

Repechage Pool 2

Junior Kumite Female -48 kg

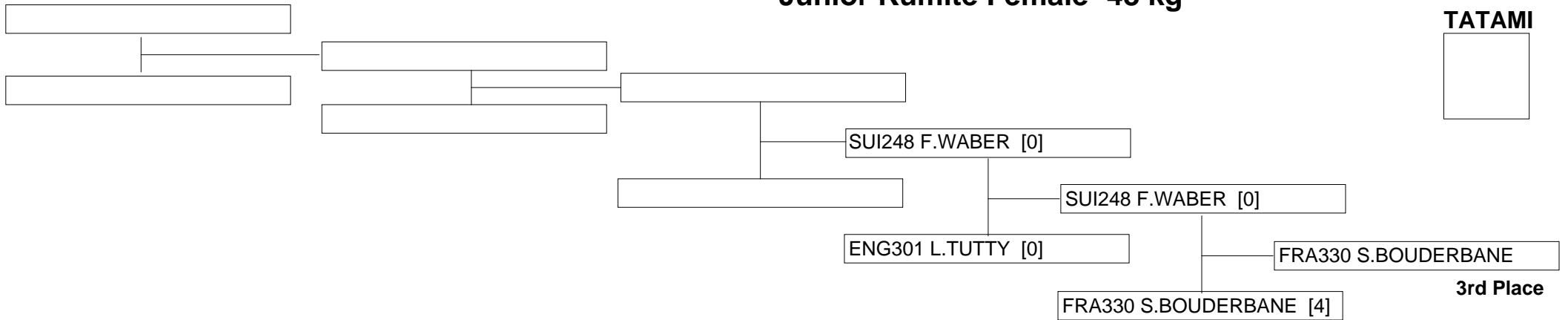



40th EKF Junior&Cadet Karate Champ. 5th Under 21

TURKEY - Konya

8/2/2013 - 10/2/2013

Junior Kumite Female -53 kg

Entries: 25

ISR162 R.EFRONI [0]
ITA395 V.LALLO [10]
TUR489 U.TOKCAN [0]
GRE302 M.ROUMELIOTI [5]
SRB339 S.DJORDJEVIC [7]
EST203 S.MEINHARD [0]
BUL238 S.VANGELOVA []
<BYE>
ENG315 S.SANTILLO [1]
BIH333 E.GLJIVA [4]
SCO184 R.GOURLAY []
<BYE>
FYR298 B.MLADENOSKA [1]
FRA499 S.SERFATI [9]
POR227 I.CERTAN []
<BYE>
CYR206 M.ADAMOU [2]
MNE208 M.MICUNOVIC [4]
SLO269 B.POKLIC []
<BYE>
GER385 E.KAYA [1]
SUI262 I.BARTOLOTTA [2]
CRO366 N.KONTOSIC []
<BYE>
HUN244 N.NOGRADI [5]
LUX153 C.SCHMIT [3]
RUS430 G.SHATEEVA []
<BYE>
UKR305 A.MIASTKOVSKA [0]
SVK298 A.CHOVANCOVA [8]
WAL147 A.NICHOLAS []
<BYE>

ITA395 V.LALLO [4]
ITA395 V.LALLO [8]
GRE302 M.ROUMELIOTI [1]
SRB339 S.DJORDJEVIC [2]
SRB339 S.DJORDJEVIC [0]
BUL238 S.VANGELOVA [0]
BIH333 E.GLJIVA [1]
BIH333 E.GLJIVA [2]
SCO184 R.GOURLAY [0]
FRA499 S.SERFATI [0]
POR227 I.CERTAN [1]
POR227 I.CERTAN [8]
MNE208 M.MICUNOVIC [4]
MNE208 M.MICUNOVIC [0]
SLO269 B.POKLIC [0]
SUI262 I.BARTOLOTTA [2]
SUI262 I.BARTOLOTTA [2]
CRO366 N.KONTOSIC [0]
HUN244 N.NOGRADI [6]
HUN244 N.NOGRADI [3]
RUS430 G.SHATEEVA [0]
SVK298 A.CHOVANCOVA [5]
SVK298 A.CHOVANCOVA [0]
WAL147 A.NICHOLAS [0]

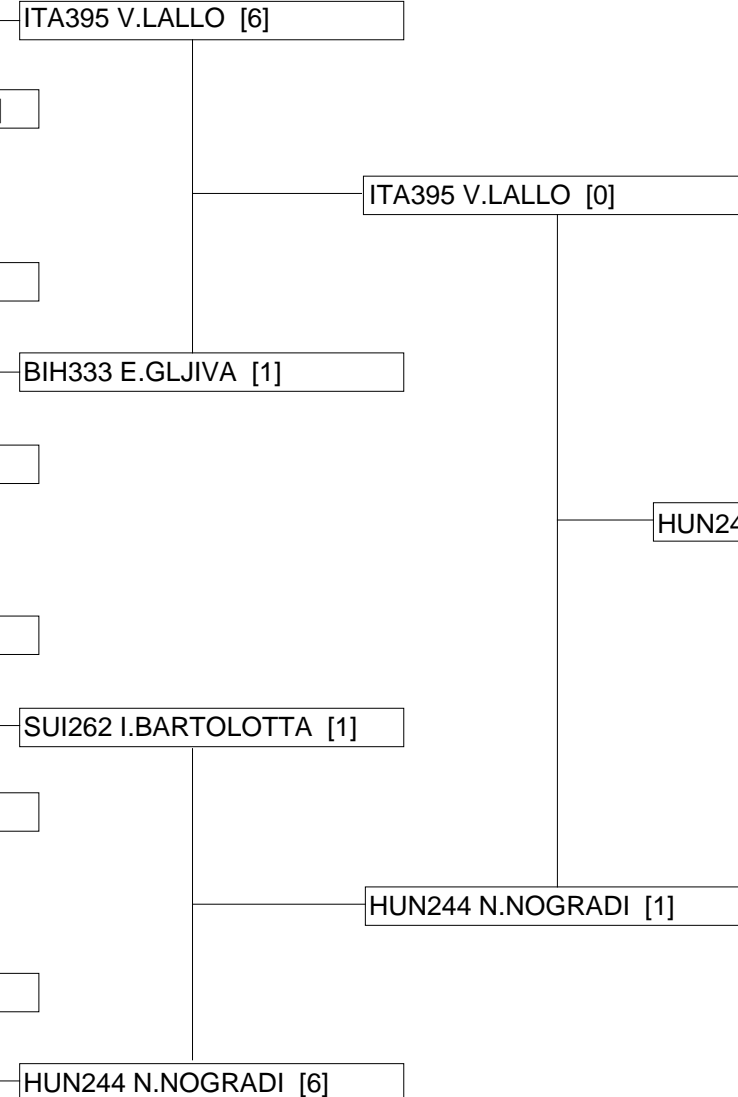

Pool 1

TATAMI

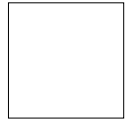

TATAMI

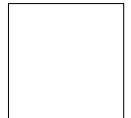

Pool 2

Junior Kumite Female -53 kg



40th EKF Junior&Cadet Karate Champ. 5th Under 21

TURKEY - Konya

8/2/2013 - 10/2/2013

Junior Kumite Female -53 kg

Repechage Pool 1

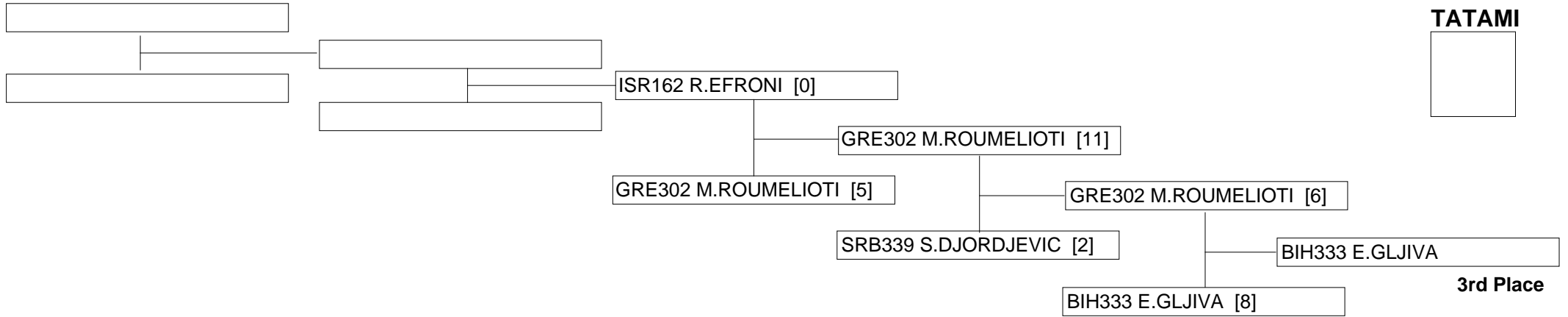

Repechage Pool 2

Junior Kumite Female -53 kg

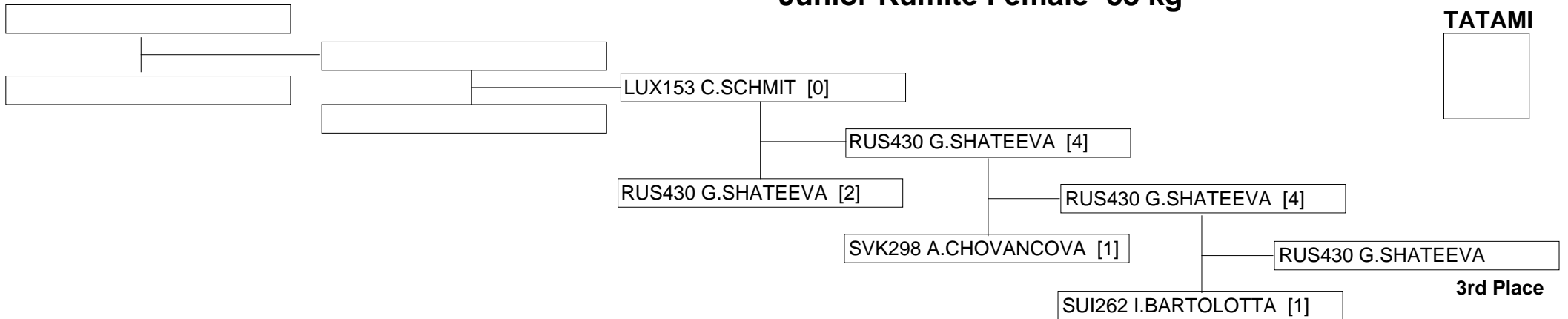



40th EKF Junior&Cadet Karate Champ. 5th Under 21

TURKEY - Konya

8/2/2013 - 10/2/2013

Junior Kumite Female -59 kg

Entries: 26

SUI264 M.FRANZOSI [1]
TUR521 H.PUNAR [8]
CRO368 J.ZOVKO [0]
FRA338 S.AMENGLÉ [6]
DEN186 J.RUPRECHT [2]
BUL293 A.STUBLEVA [0]
GRE688 D.STOLTIDOU []
<BYE>
HUN204 R.GYORIVANYI [3]
AUT215 R.RIEDER [0]
GER368 K.SCHWEIER []
<BYE>
ESP505 A.DIEPA [3]
NED200 K.ZWAKHALEN [1]
SWE202 H.NILSSON []
<BYE>
BIH319 T.MARIC [5]
BEL205 Y.EL MASAUDI [0]
RUS505 L.BESPALAYA [0]
SRB274 J.PREKOVIC [4]
MNE239 A.MIJATOVIC [0]
SVK291 M.KOPUNOVA [2]
CZE223 V.RACAKOVA []
<BYE>
POR245 A.SIMAO [2]
AND133 S.HERVER [0]
ENG291 C.WASTELL []
<BYE>
SLO259 K.FLORJANCIC [1]
ITA370 V.COLANTUONO [1]
UKR258 I.ZARETSKA []
<BYE>





40th EKF Junior&Cadet Karate Champ. 5th Under 21

TURKEY - Konya

8/2/2013 - 10/2/2013

Junior Kumite Female -59 kg

Repechage Pool 1

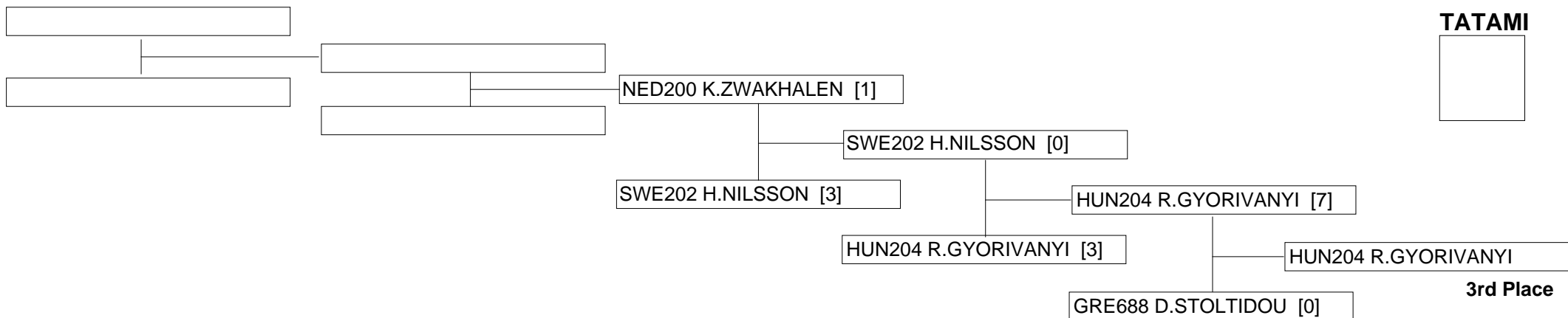

Repechage Pool 2

Junior Kumite Female -59 kg

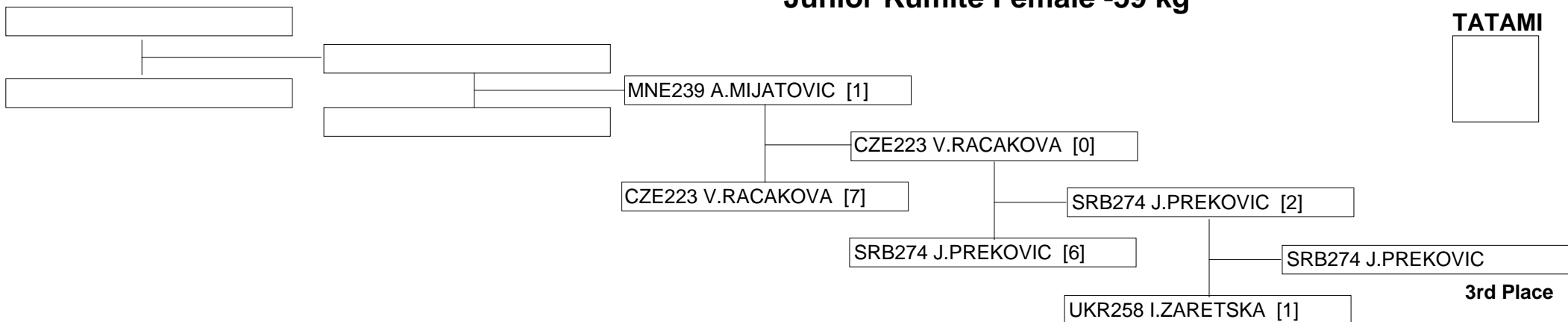



40th EKF Junior&Cadet Karate Champ. 5th Under 21

TURKEY - Konya

8/2/2013 - 10/2/2013

Junior Kata Female

Entries: 26

- CRO365 N.JUKIC [Gsh/Sho]
- SUI214 V.WILL [Enpi]
- ESP434 M.MORATA [Unshu]
- BLR212 M.FURSAVA [Annan]
- FIN199 L.TAMMINEN [Gsh/Sho]
- FRA326 P.BOUCHEM [Enpi]
- ITA308 T.D ONOFRIO []
- <BYE>
- GRE318 E.BYROU [Gsh/Sho]
- RUS508 I.TROITSKAYA [Kank]
- SVK317 A.OVECKOVA []
- <BYE>
- GER387 S.GRAF [Kank Sho]
- DEN181 R.LINCK [Chat Kus]
- SLO239 A.HLADNIK []
- <BYE>
- LAT216 L.AGAFONOVA [Unsu]
- FYR263 N.GJORGJEVIK [Kank]
- HUN214 L.STERCK [Paiku]
- CZE258 T.ZLATOHLAVKOVA []
- SWE182 E.ERNEKRANS [Nipa]
- ENG285 A.SELL [Nipaipo]
- TUR346 R.KUSMUS []
- <BYE>
- POR187 M.SANTOS [Annan]
- SRB260 B.MLADEZIC [Kank S]
- AUT223 J.RATH []
- <BYE>
- SCO216 S.WILSON [Enpi]
- UKR270 A.KRESHCHENKO [K]
- LUX133 O.DA COSTA []
- <BYE>



Pool 1

TATAMI

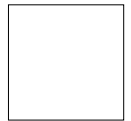

TATAMI

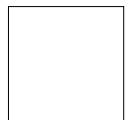

Pool 2

Junior Kata Female



40th EKF Junior&Cadet Karate Champ. 5th Under 21

TURKEY - Konya

8/2/2013 - 10/2/2013

Junior Kata Female

Repechage Pool 1

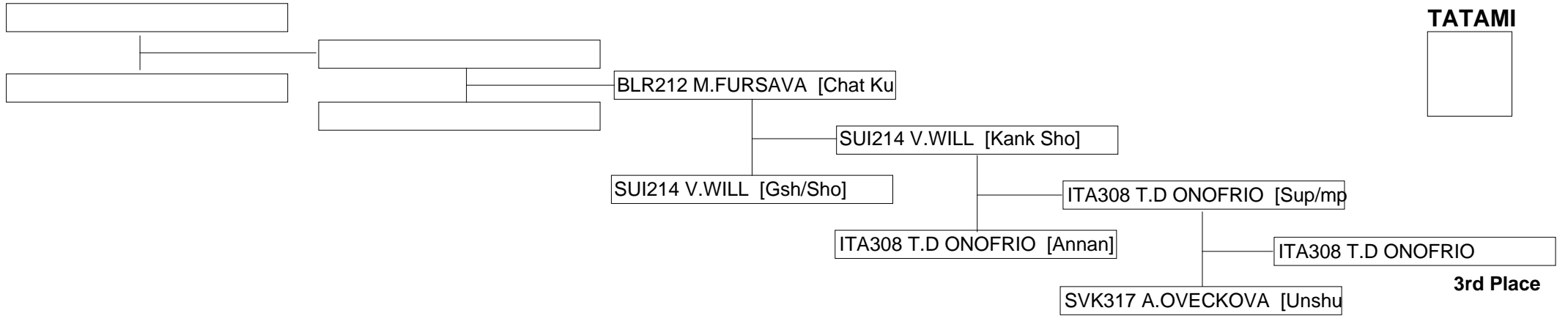

Repechage Pool 2

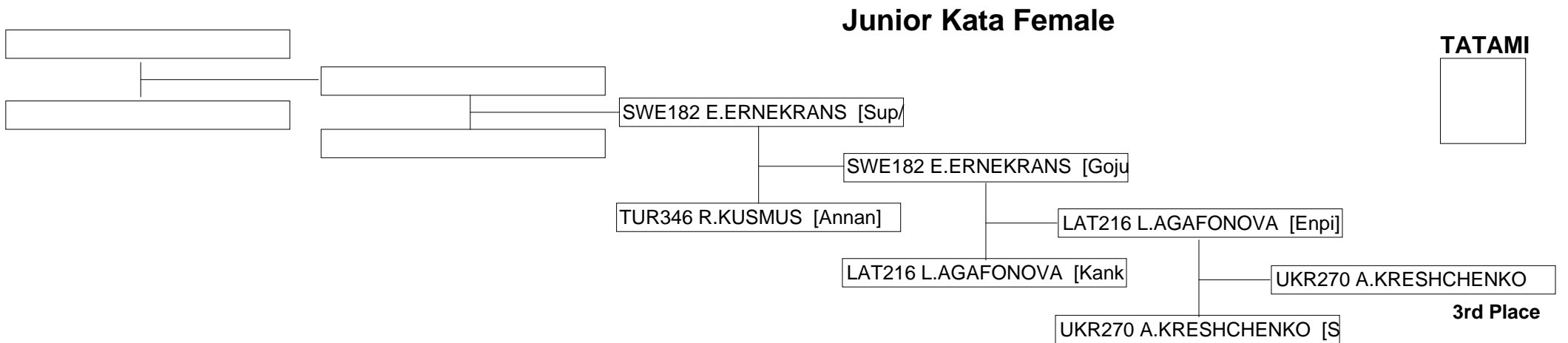



40th EKF Junior&Cadet Karate Champ. 5th Under 21

TURKEY - Konya

8/2/2013 - 10/2/2013

Junior Kata Male

Entries: 28

- SLO245 A.KLANECEK [Kank D
- HUN216 M.GRECZI [Heiku]
- POR244 A.SANTOS [Gsh/Sho]
- SWE203 L.ORTERSTROM [Ch
- ESP513 A.GARCIA VARGAS [
- DEN182 A.EKKERT [Annan]
- GER359 M.SCHINKE []
- <BYE>
- BIH316 N.TOPIC [Kank Dai]
- CYR193 C.NICOLAOU [Sup/m
- GRE362 A.POLICHRONOS [K
- TUR353 A.SOFUOGLU [Enpi]
- ITA505 S.STEA [Gsh/Sho]
- SRB426 D.SRDJEVIC [Unsu]
- AZE246 R.ALIYEV []
- <BYE>
- LUX140 E.PEREIRA HENRIQU
- FRA534 K.NGOAN [Enpi]
- CRO334 M.MORZAN [Gsh/Sho
- BEL194 P.TRESEGNIE [Kank
- ISR146 S.RAFAILOV [Sochin]
- FYR273 V.BESLIEV [Gsh/Sho]
- ENG317 N.PATEL []
- <BYE>
- SCO206 J.SZAFRANEK [Sup/
- CZE230 D.WOJTYLA [Gsh/Dai]
- SVK299 J.BORECKY [Chat Ku
- RUS392 M.KSENOFONTOV [G
- FIN181 R.SALMI [Unsu]
- AUT258 D.SZABO [Kank Sho]
- MNE258 D.VUKOTIC []
- <BYE>





40th EKF Junior&Cadet Karate Champ. 5th Under 21

TURKEY - Konya

8/2/2013 - 10/2/2013

Junior Kata Male

Repechage Pool 1

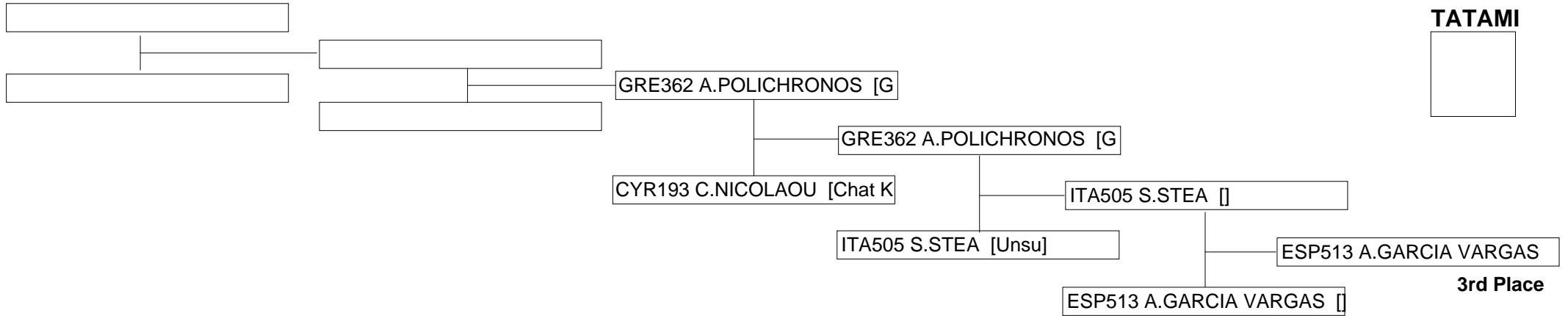

Repechage Pool 2

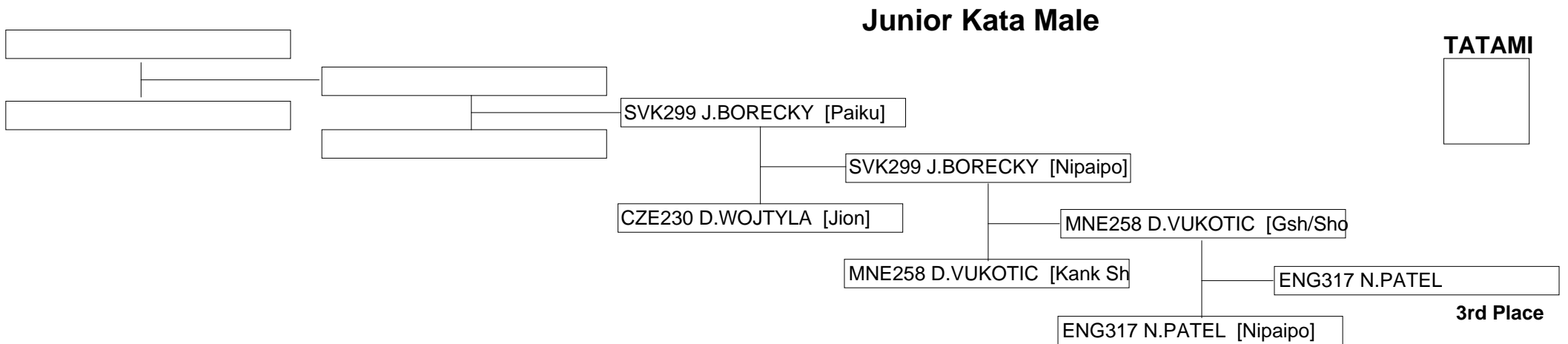



40th EKF Junior&Cadet Karate Champ. 5th Under 21

TURKEY - Konya

8/2/2013 - 10/2/2013

Junior Kumite Male 76+ kg

TATAMI

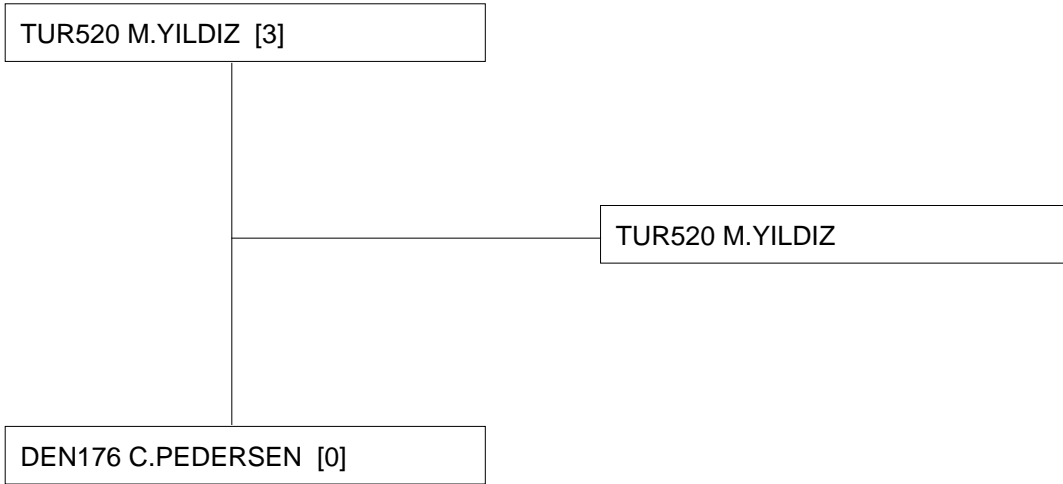



40th EKF Junior&Cadet Karate Champ. 5th Under 21

TURKEY - Konya

8/2/2013 - 10/2/2013

Entries: 33

Junior Kumite Male 76+ kg

Pool 1

TATAMI

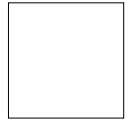

TATAMI

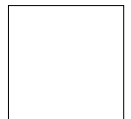

POR222 H.RAMOS [2]
FYR335 E.RISTEVSKI [1]
ISR158 A.BERCOVICH []
<BYE>
BIH264 B.MEHOVIC []
<BYE>
MNE262 M.PETRIC []
<BYE>
ITA379 P.LONGBARDI []
<BYE>
AZE253 S.GULUZADE []
<BYE>
GRE523 N.VAVOULIDIS []
<BYE>
ROM269 C.MIHALACHE []
<BYE>
CRO367 A.KVESIC []
<BYE>
ARM148 G.KALASHYAN []
<BYE>
CYR320 E.NICOLAOU []
<BYE>
SRB308 N.PLANIC []
<BYE>
FIN184 P.HEISKANEN []
<BYE>
NOR175 J.MALINVERNO []
<BYE>
LAT222 R.KORNISOVS []
<BYE>
TUR520 M.YILDIZ []
<BYE>



Junior Kumite Male 76+ kg



40th EKF Junior&Cadet Karate Champ. 5th Under 21

TURKEY - Konya

8/2/2013 - 10/2/2013

Junior Kumite Male 76+ kg

Entries: 33

AUT258 D.SZABO []
<BYE>
BLR226 A.ISAKAU []
<BYE>
UKR299 T.HERCHUK []
<BYE>
SLO257 P.SUMANDL []
<BYE>
GER361 B.KERBER []
<BYE>
SVK302 I.KABASHI []
<BYE>
DEN176 C.PEDERSEN []
<BYE>
SWE199 O.DACKLAND []
<BYE>
ESP557 D.ARANA []
<BYE>
RUS438 A.SAMARINOV []
<BYE>
GEO170 G.KARELI []
<BYE>
ENG302 J.OTTO []
<BYE>
BEL192 S.ADAMS []
<BYE>
CZE249 O.ANDORFER []
<BYE>
HUN242 C.FOLDESI []
<BYE>
EST191 T.PAABO []
<BYE>





40th EKF Junior&Cadet Karate Champ. 5th Under 21

TURKEY - Konya

8/2/2013 - 10/2/2013

Junior Kumite Male 76+ kg

Repechage Pool 1

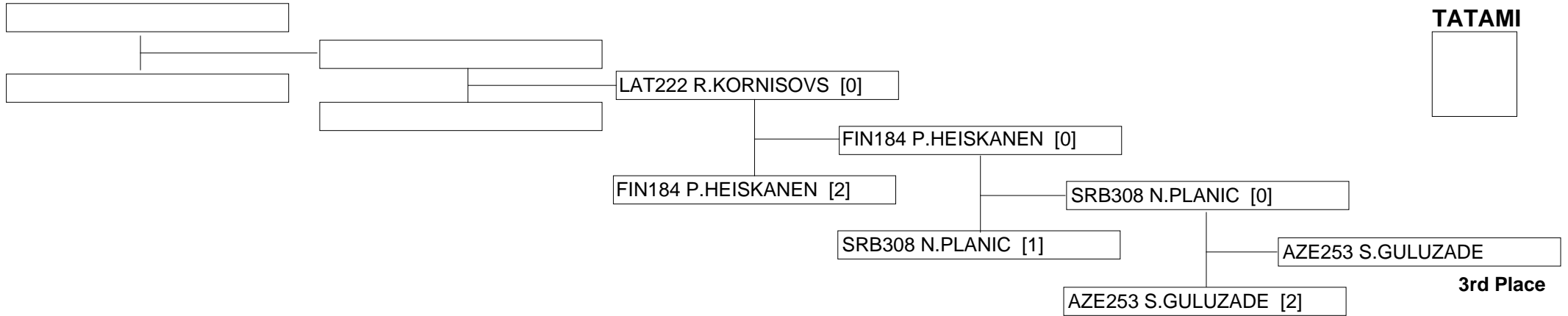

Repechage Pool 2

Junior Kumite Male 76+ kg

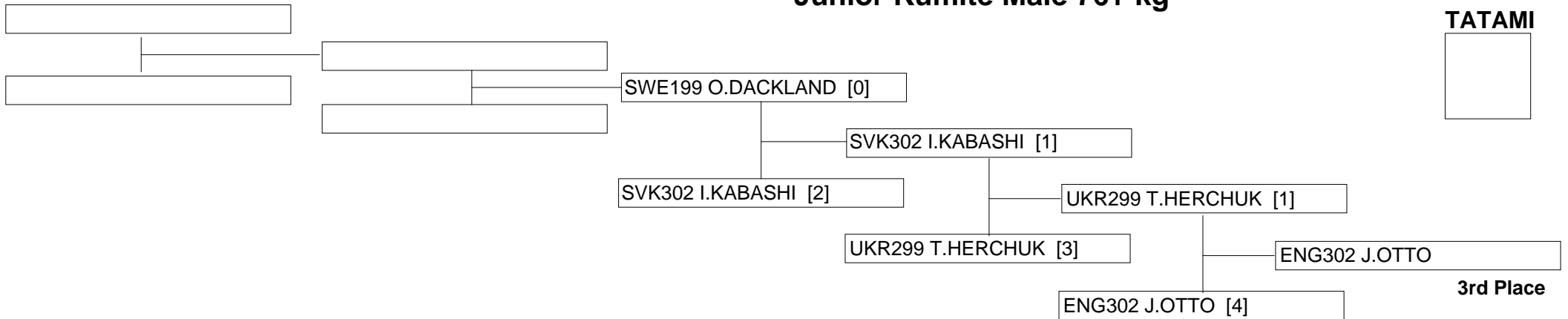



40th EKF Junior&Cadet Karate Champ. 5th Under 21

TURKEY - Konya

8/2/2013 - 10/2/2013

Entries: 27

Junior Kumite Male -55 kg

Pool 1

TATAMI



BIH326 I.KRIZANAC [5]
RUS473 S.OGANIAN [0]
FRA531 K.TAVARES LOPES []
ENG316 C.HOLMES [1]
FIN197 M.MAKKONEN [0]
IRL135 A.MCLOUGHLIN [5]
TUR743 G.FILIZ []
<BYE>
POR246 J.XAVIER [2]
SWE206 A.TAFARI [3]
FYR383 M.GJURCHINOVSKI []
HUN257 T.DERZSI [3]
GRE429 M.RELIAS [1]
AZE272 J.SAFARLI [4]
UKR313 D.KORNIYCHUK []
<BYE>
BLR239 V.PAPRUHA [4]
ISR169 R.VERSOLKER [3]
SLO277 D.GORENC [1]
ITA511 L.BISACCIA [7]
GER418 V.FUCHS [4]
SRB307 D.AHMETOVIC [0]
ROM270 V.RADU []
<BYE>
CYR192 I.KYROY [0]
SUI250 G.DELETROZ [3]
MNE233 A.MARKASHEVIQ []
<BYE>
CRO343 B.BERAK [1]
SVK318 R.STYRIAK [0]
BEL222 I.BELLARAJ []
<BYE>



TATAMI

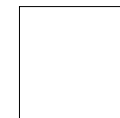

Pool 2

Junior Kumite Male -55 kg



40th EKF Junior&Cadet Karate Champ. 5th Under 21

TURKEY - Konya

8/2/2013 - 10/2/2013

Junior Kumite Male -55 kg

Repechage Pool 1

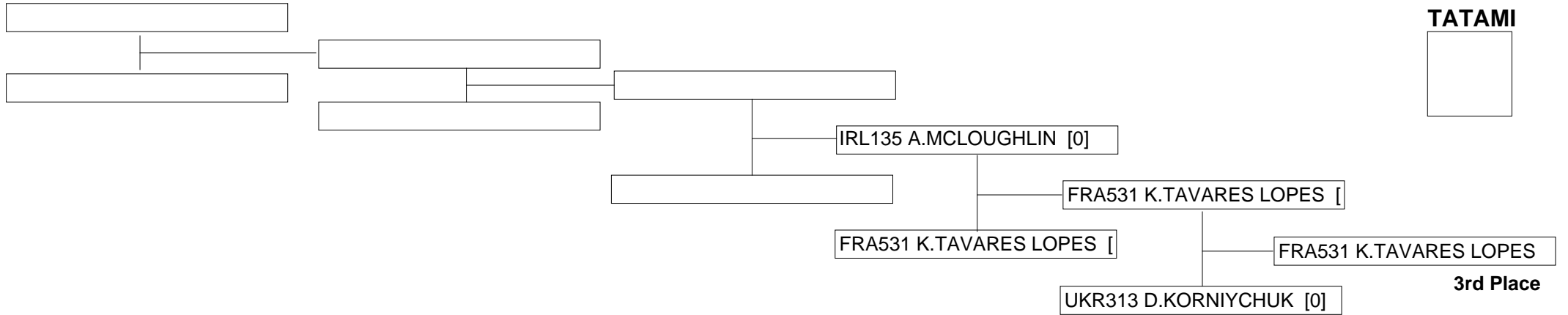

Repechage Pool 2

Junior Kumite Male -55 kg

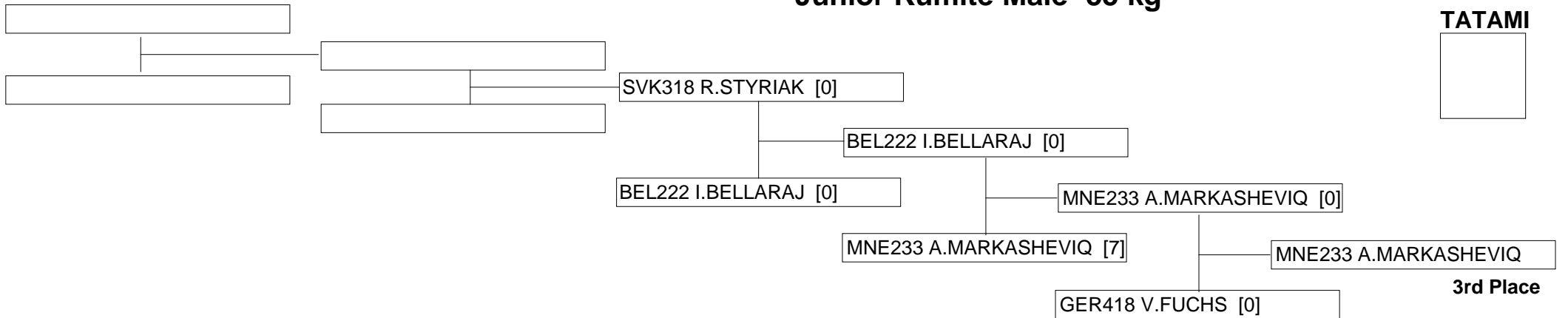



40th EKF Junior&Cadet Karate Champ. 5th Under 21

TURKEY - Konya

8/2/2013 - 10/2/2013

Junior Kumite Male -61 kg

TATAMI

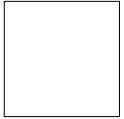

FRA412 S.DACOSTA [5]

FRA412 S.DACOSTA

DEN192 C.NOERSKOV-JENSEN [0]

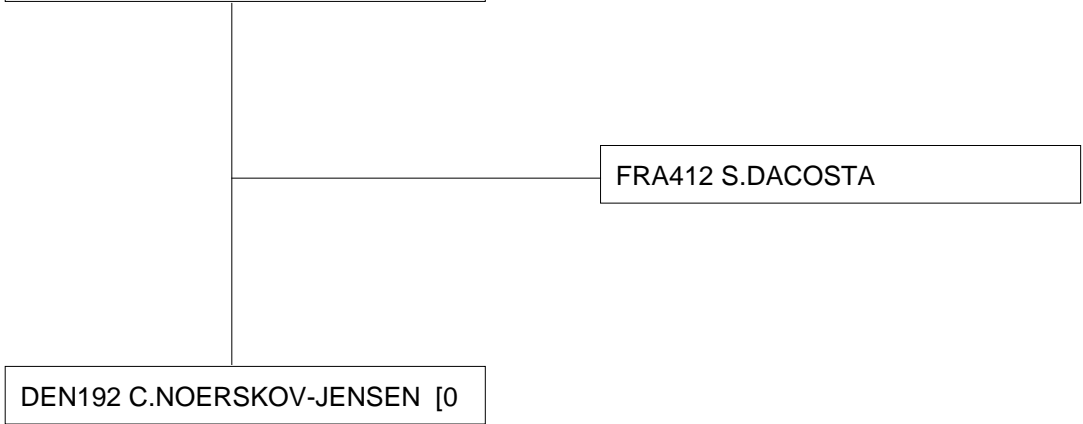



40th EKF Junior&Cadet Karate Champ. 5th Under 21

TURKEY - Konya

8/2/2013 - 10/2/2013

BIH314 E.GALIC [7]
ISR159 O.CANDITAN [0]
SRB419 A.LEKIC []
<BYE>
LUX136 J.VAN SCHIL []
<BYE>
LAT223 .KOSTILEVS []
<BYE>
FYR299 M.STOJMENOV []
<BYE>
FIN196 T.LINDHOLM []
<BYE>
SUI268 B.SCHMIDLIN []
<BYE>
NED213 E.VAN KLEEF []
<BYE>
ITA335 V.ACERBO []
<BYE>
HUN256 P.VIRGA []
<BYE>
TUR749 F.MERCAN []
<BYE>
UKR321 R.ZHYVKO []
<BYE>
IRL150 J.REILLY []
<BYE>
BUL260 A.DIMITROV []
<BYE>
RUS435 I.PONOMAREV []
<BYE>
FRA412 S.DACOSTA []
<BYE>



Junior Kumite Male -61 kg

Entries: 33

Pool 1

TATAMI



TATAMI

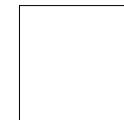

Junior Kumite Male -61 kg



40th EKF Junior&Cadet Karate Champ. 5th Under 21

TURKEY - Konya

8/2/2013 - 10/2/2013

Junior Kumite Male -61 kg

Entries: 33

Pool 2

TATAMI

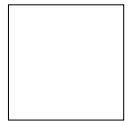

TATAMI

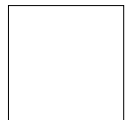

- BLR229 A.NIARUBENKA []
- <BYE>
- AUT234 L.RETTENBACHER []
- <BYE>
- AZE260 N.ABBASOV []
- <BYE>
- SLO270 N.BERTONCELJ []
- <BYE>
- SVK333 J.HUDEC []
- <BYE>
- CRO373 R.SGARDELLI []
- <BYE>
- POR248 R.GAVINHO []
- <BYE>
- EST185 R.VALIJEV []
- <BYE>
- ARM152 K.ANDRESYAN []
- <BYE>
- NOR159 B.HJERPAASEN []
- <BYE>
- ROM267 B.GOGOLOSI []
- <BYE>
- CZE246 J.KOUDELKA []
- <BYE>
- GRE506 D.MITAKOS []
- <BYE>
- DEN192 C.NOERSKOV-JENSE
- <BYE>
- ENG282 J.KIERNAN []
- <BYE>
- SCO208 A.EL SHAFEI []
- <BYE>



Junior Kumite Male -61 kg



40th EKF Junior&Cadet Karate Champ. 5th Under 21

TURKEY - Konya

8/2/2013 - 10/2/2013

Junior Kumite Male -68 kg

TATAMI



BIH447 A.BRICA [0]

TUR492 B.UYGUR

TUR492 B.UYGUR [1]

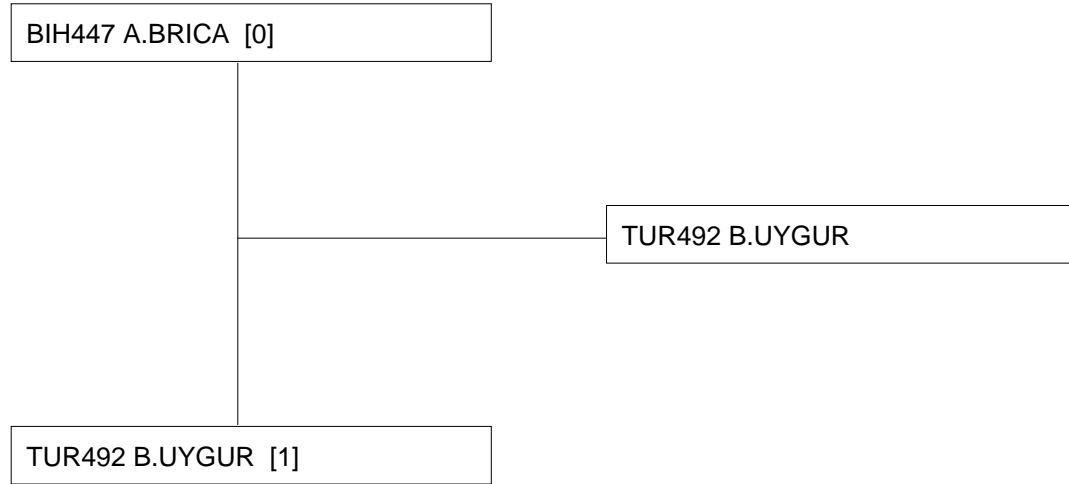



40th EKF Junior&Cadet Karate Champ. 5th Under 21

TURKEY - Konya

8/2/2013 - 10/2/2013

Junior Kumite Male -68 kg

Entries: 36

ESP515 R.CUERVA MORA [8]
SCO209 J.BRADLEY [0]
<BYE>
GEO174 N.CHKHAIDZE []
<BYE>
HUN203 N.SZILVA []
<BYE>
NED205 N.GERRESE []
<BYE>
SUI213 R.WEIBEL []
<BYE>
ARM143 S.SARGSYAN []
<BYE>
GER357 F.BEHRENDT []
<BYE>
FRA532 C.SEGUY []
<BYE>
BIH447 A.BRICA [1]
POR252 G.MARTA [0]
ISR154 D.AFSANOV []
<BYE>
BEL191 J.CUSTINNE []
<BYE>
SWE204 E.SABIC []
<BYE>
LUX143 S.DA FONTE []
<BYE>
MNE370 A.PALAMAR []
<BYE>
AUT247 R.RETTENBACHER []
<BYE>
EST198 I.TSIBISOV []
<BYE>

ESP515 R.CUERVA MORA [3]
ESP515 R.CUERVA MORA [1]
GEO174 N.CHKHAIDZE [0]
HUN203 N.SZILVA [5]
HUN203 N.SZILVA [0]
NED205 N.GERRESE [0]
SUI213 R.WEIBEL [1]
ARM143 S.SARGSYAN [3]
ARM143 S.SARGSYAN [6]
ARM143 S.SARGSYAN [2]
GER357 F.BEHRENDT [4]
GER357 F.BEHRENDT [0]
FRA532 C.SEGUY [1]
BIH447 A.BRICA [1]
BIH447 A.BRICA [4]
ISR154 D.AFSANOV [0]
BEL191 J.CUSTINNE [0]
SWE204 E.SABIC [1]
SWE204 E.SABIC [8]
LUX143 S.DA FONTE [2]
LUX143 S.DA FONTE [2]
MNE370 A.PALAMAR [0]
AUT247 R.RETTENBACHER [0]
EST198 I.TSIBISOV [1]
EST198 I.TSIBISOV [8]
EST198 I.TSIBISOV [3]



Pool 1

TATAMI

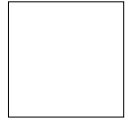

TATAMI

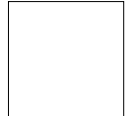

Junior Kumite Male -68 kg



40th EKF Junior&Cadet Karate Champ. 5th Under 21

TURKEY - Konya

8/2/2013 - 10/2/2013

Junior Kumite Male -68 kg

Entries: 36

ITA307 F.D ONOFRIO [3]
FYR342 A.ISMAIL [0]
RUS452 N.RODIONOV []
<BYE>
AZE269 S.GULUZADE []
<BYE>
GRE307 D.XENOS []
<BYE>
BLR222 I.KIRZNER []
<BYE>
UKR310 S.DROZD []
<BYE>
SLO255 T.OTRIN []
<BYE>
CRO332 I.MARTINAC []
<BYE>
DEN162 T.PEDERSEN [3]
BUL221 E.SERBEST [1]
IRL145 J.HARRIGAN []
<BYE>
ENG314 J.KELLAWAY []
<BYE>
SVK296 M.HOMOLA []
<BYE>
CYR189 S.SALATAS []
<BYE>
TUR492 B.UYGUR []
<BYE>
FIN200 A.TUOMINEN []
<BYE>
SRB425 S.NESKOVIC []
<BYE>





40th EKF Junior&Cadet Karate Champ. 5th Under 21

TURKEY - Konya

8/2/2013 - 10/2/2013

Junior Kumite Male -68 kg

Repechage Pool 1

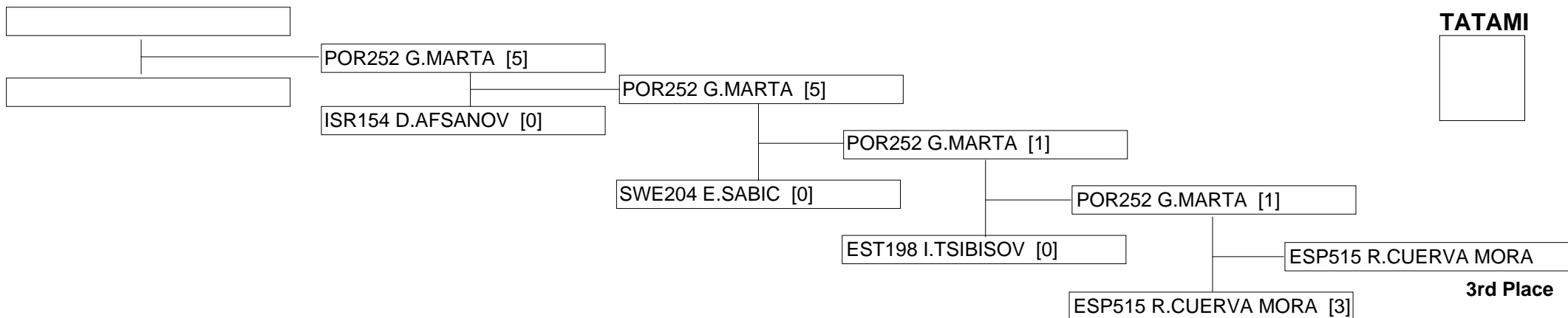

Repechage Pool 2

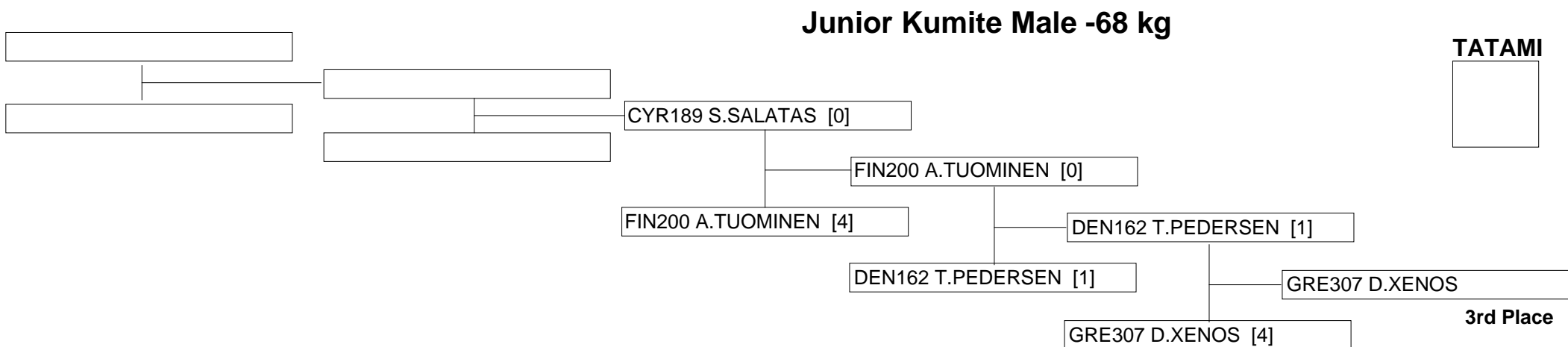



40th EKF Junior&Cadet Karate Champ. 5th Under 21

TURKEY - Konya

8/2/2013 - 10/2/2013

Junior Kumite Male -76 kg

Entries: 28

GEO173 N.KOBALIA [2]
CRO374 V.LONCAR [1]
FRA367 M.LECLAIRE [0]
MNE263 V.KOPITOVIC [1]
HUN258 G.HARSPATAKI [3]
UKR301 R.KMIT [0]
SLO234 F.SPANBAUER []
<BYE>
GER369 L.SIEBEL [0]
DEN188 K.KORTE [3]
FYR270 V.KRSTEVSKI [4]
BUL339 R.VACHEV [1]
CYR287 T.LOIZIDES [0]
POR182 T.SENRA [3]
ROM266 N.DANCILA []
<BYE>
RUS459 A.GANZEN [7]
ITA514 M.HASANI [0]
AZE242 M.HASANLI [0]
LAT212 J.KOROLKOVS [8]
BIH446 A.ALIVUK [2]
SVK321 M.DZACOVSKY [4]
SWE198 V.BULL []
<BYE>
GRE272 T.KALOGIANNIS [2]
TUR331 U.AKTAS [3]
NOR161 A.SLETTEVOLD [2]
ENG318 A.TAYLOR [1]
LUX140 E.PEREIRA HENRIQU
SRB273 B.MISOVIC [0]
ISR166 E.SHAPIRA []
<BYE>

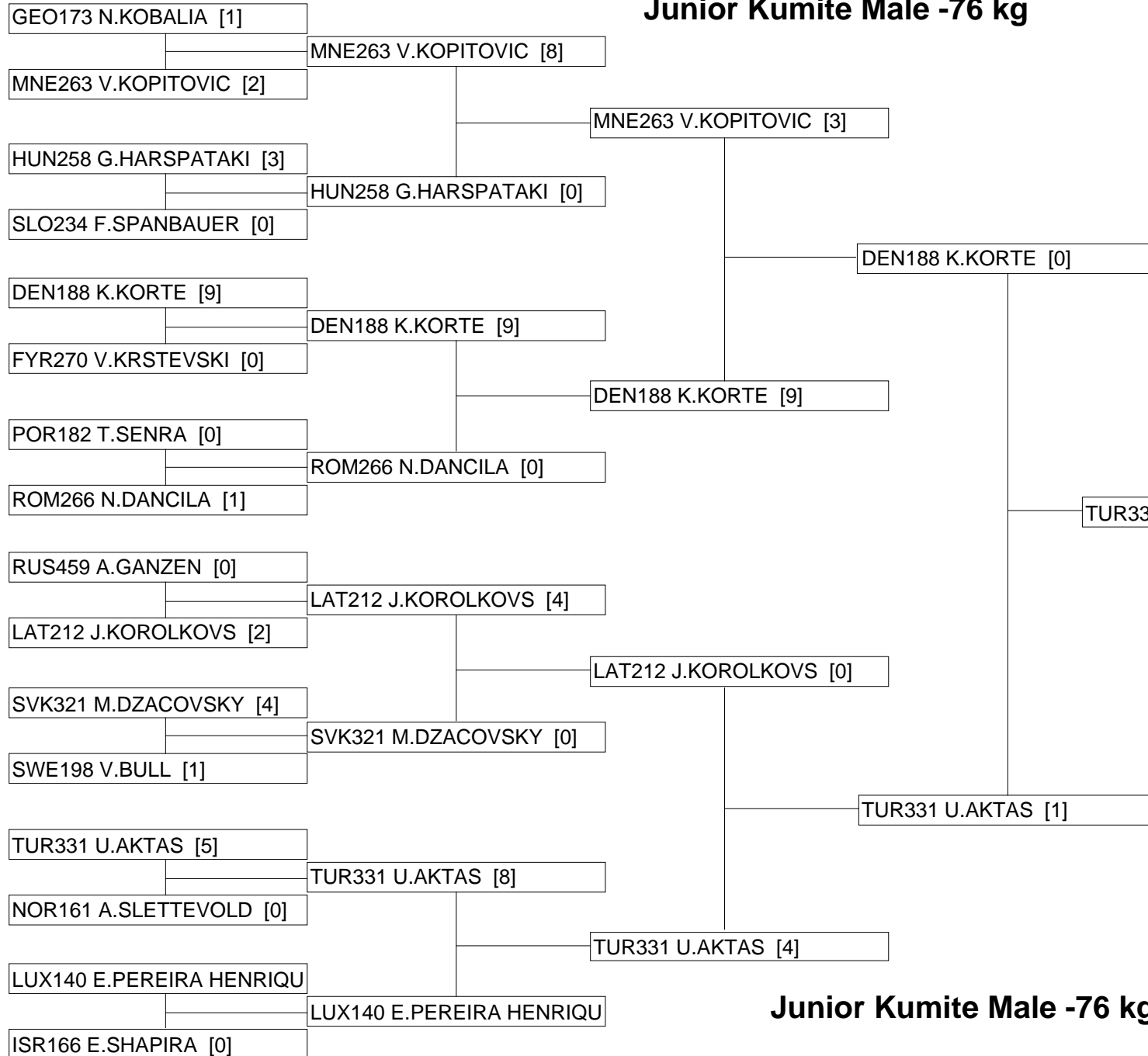

Pool 1

TATAMI

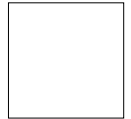

TATAMI

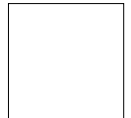

Pool 2

Junior Kumite Male -76 kg



40th EKF Junior&Cadet Karate Champ. 5th Under 21

TURKEY - Konya

8/2/2013 - 10/2/2013

Junior Kumite Male -76 kg

Repechage Pool 1

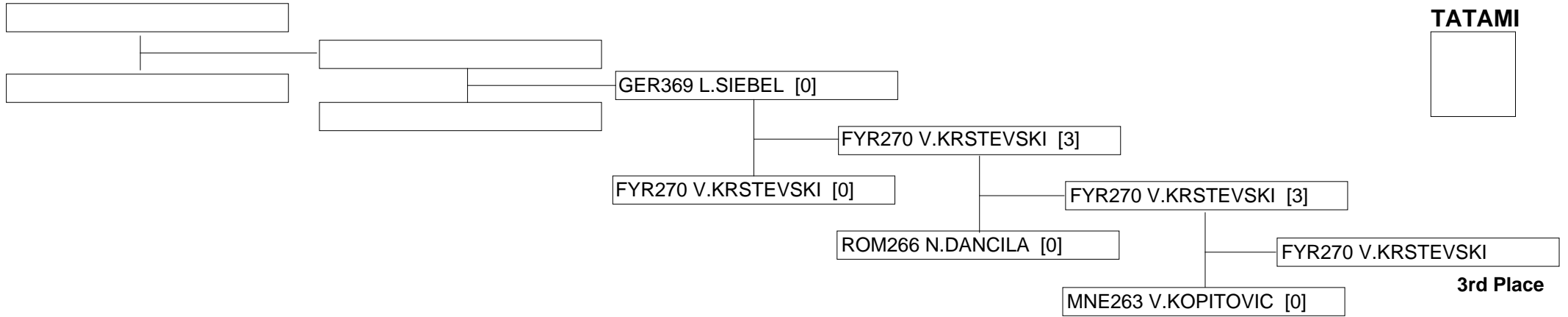

Repechage Pool 2

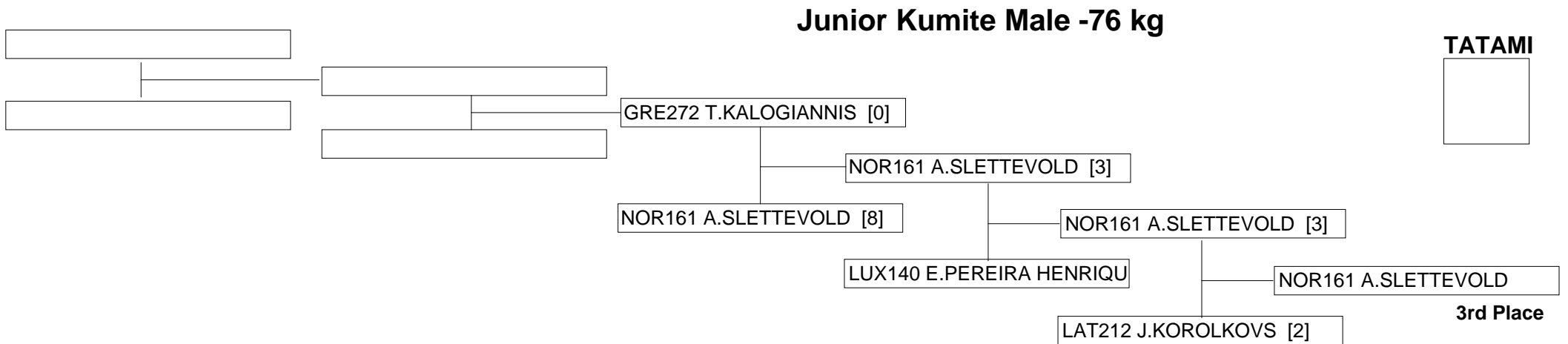



40th EKF Junior&Cadet Karate Champ. 5th Under 21

TURKEY - Konya

8/2/2013 - 10/2/2013

Under 21 Kata Male

Entries: 25

- BEL184 Y.RODRIGUEZ MERIN
- CRO289 A.HAURDIC [Gsh/Sho]
- SUI261 F.ASTORINA [Enpi]
- DEN146 C.ROHDE [Kur/nfa]
- FRA410 E.MONTARELLO [Gsh]
- SVK305 P.FABIAN [Chat Kus]
- RUS344 E.SKOVORODNIKOV
- <BYE>
- SRB199 S.CHEMLAL [Gsh/Dai]
- FYR445 D.PETKOSKI [Chat Ku]
- HUN196 B.NAGY []
- <BYE>
- AZE206 T.BALJANLI [Enpi]
- POR233 L.SILVA [Kank Dai]
- TUR314 M.YAKAN []
- <BYE>
- BUL338 R.BOBEV [Enpi]
- CZE203 K.IMRISEK [Chat Kus]
- AUT193 C.ERLENWEIN []
- <BYE>
- LUX123 I.POCERVINA [Enpi]
- WAL150 R.ADEY [Enpi]
- SLO217 K.PLAZAR []
- <BYE>
- ITA322 M.BUSATO [Gsh/Sho]
- ENG279 A.GARDNER [Kank S]
- GER298 P.BAUM []
- <BYE>
- GRE242 P.KLEVAR [Annan]
- SWE175 S.BIRANVAND [Kank]
- NED212 F.DE BOER []
- <BYE>

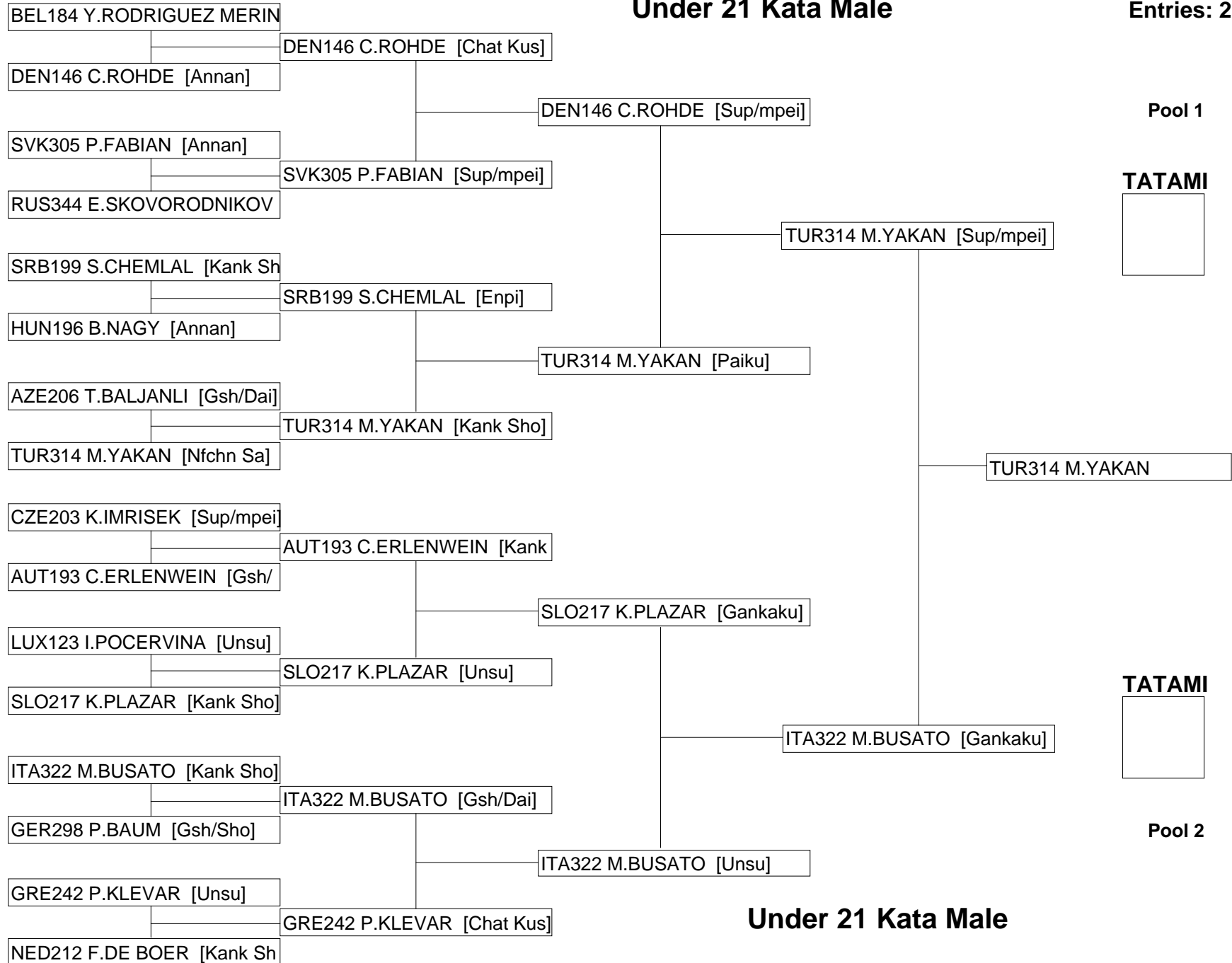



40th EKF Junior&Cadet Karate Champ. 5th Under 21

TURKEY - Konya

8/2/2013 - 10/2/2013

Under 21 Kata Male

Repechage Pool 1

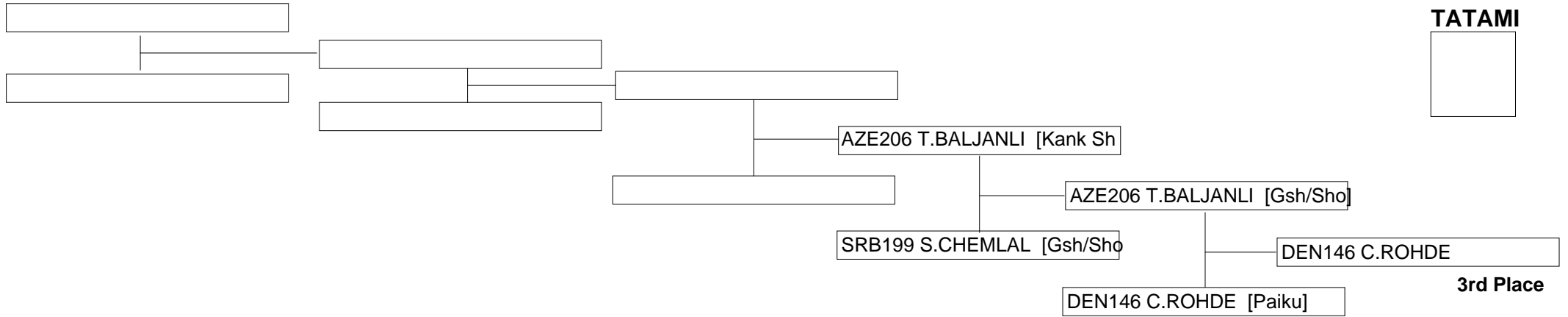

Repechage Pool 2

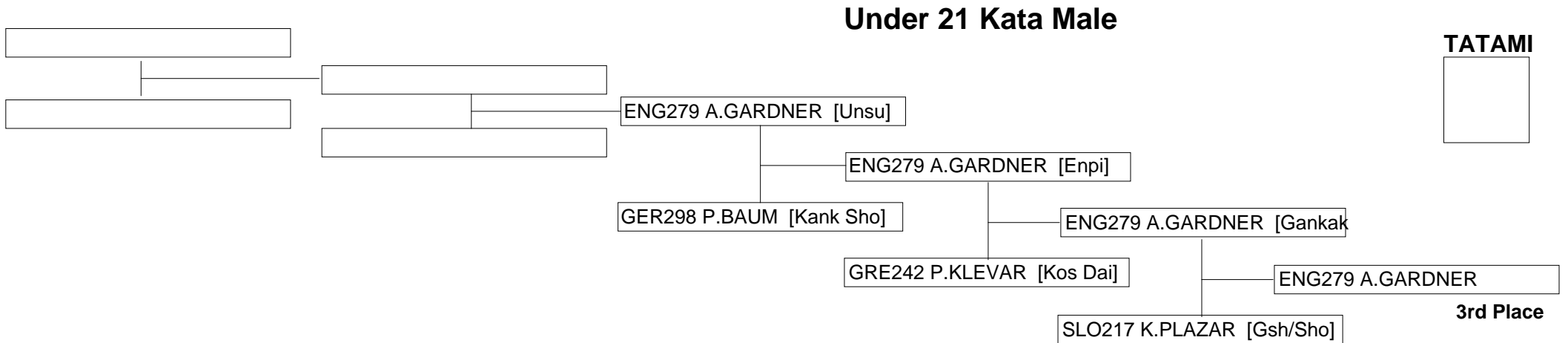



40th EKF Junior&Cadet Karate Champ. 5th Under 21

TURKEY - Konya

8/2/2013 - 10/2/2013

Cadet/Junior Team Kata Female

Entries: 11

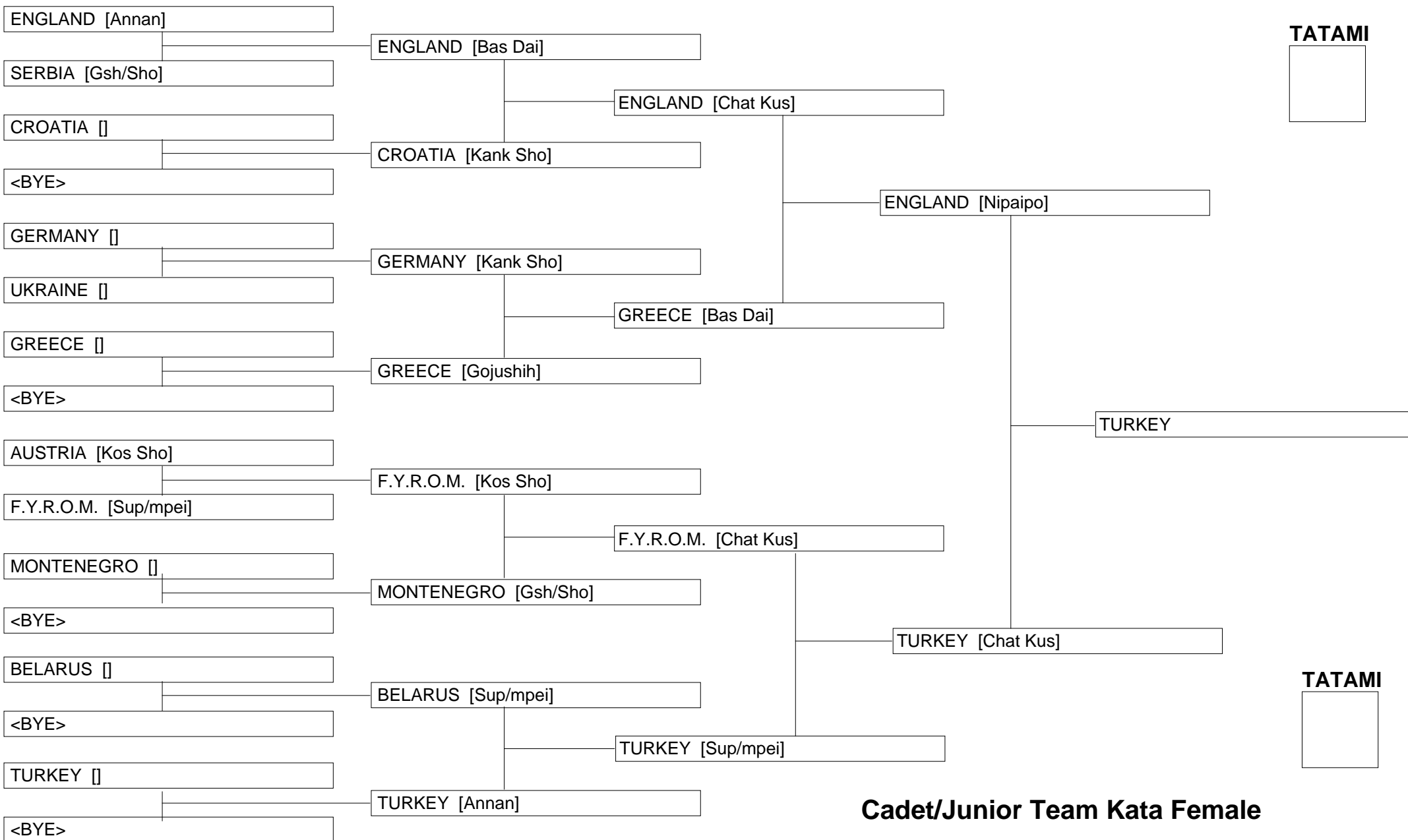

TATAMI

TATAMI

Cadet/Junior Team Kata Female



40th EKF Junior&Cadet Karate Champ. 5th Under 21

TURKEY - Konya

8/2/2013 - 10/2/2013

Cadet/Junior Team Kata Female

Repechage Pool 1

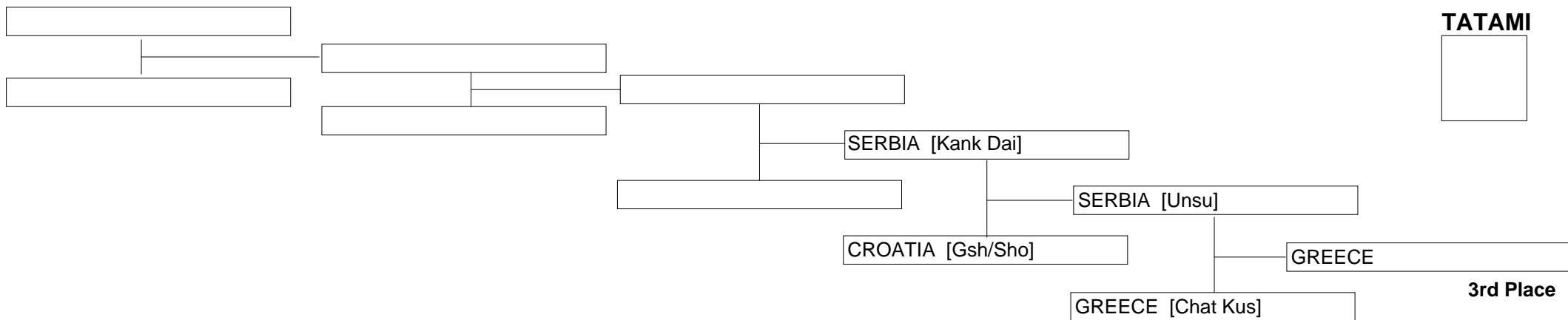

Repechage Pool 2

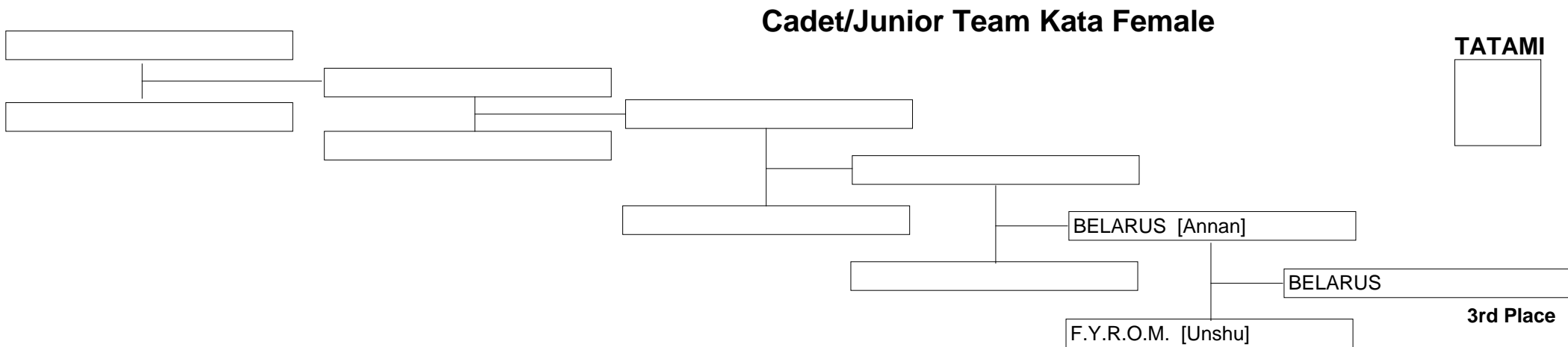



40th EKF Junior&Cadet Karate Champ. 5th Under 21

TURKEY - Konya

8/2/2013 - 10/2/2013

Cadet/Junior Team Kata Male

Entries: 6

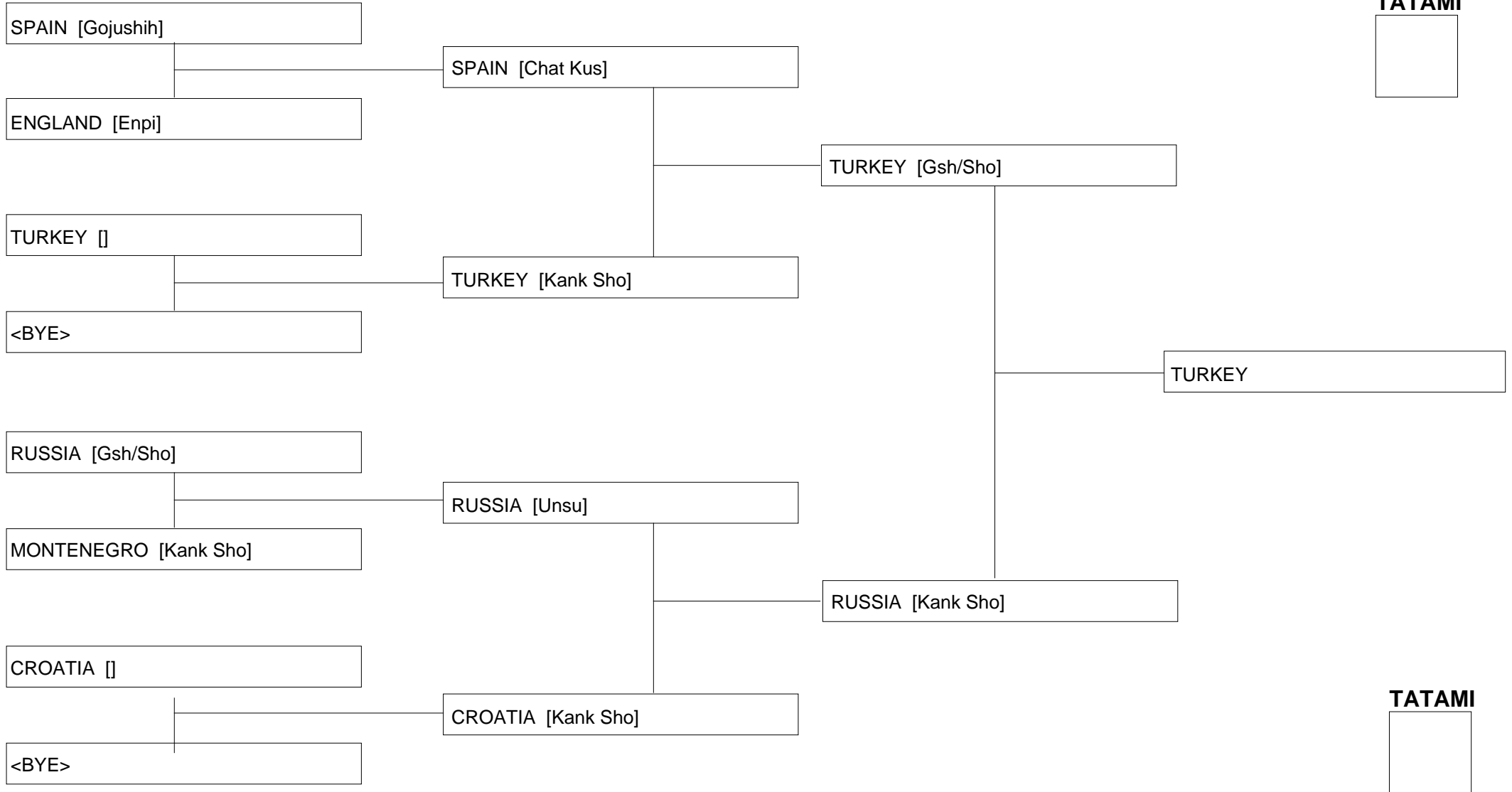

Cadet/Junior Team Kata Male



40th EKF Junior&Cadet Karate Champ. 5th Under 21

TURKEY - Konya

8/2/2013 - 10/2/2013

Cadet/Junior Team Kata Male

Repechage Pool 1

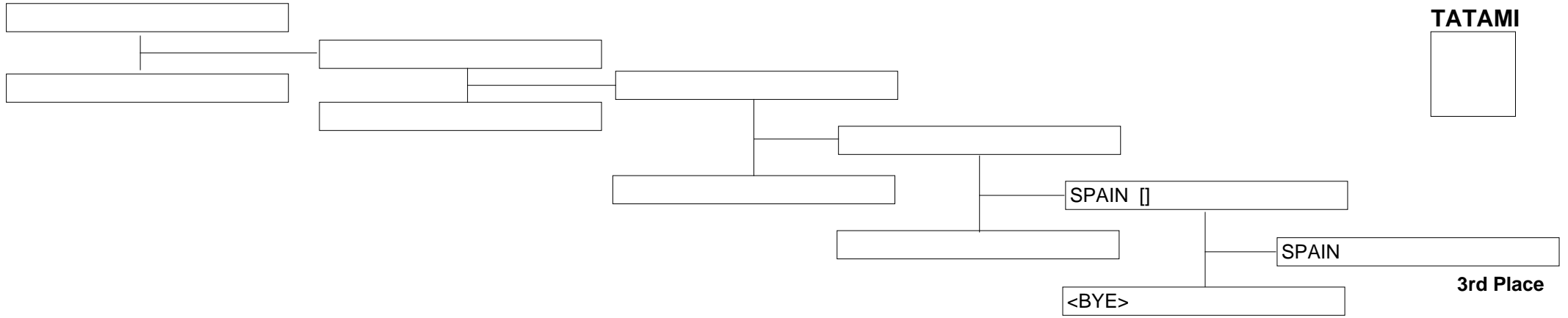

Repechage Pool 2

Cadet/Junior Team Kata Male

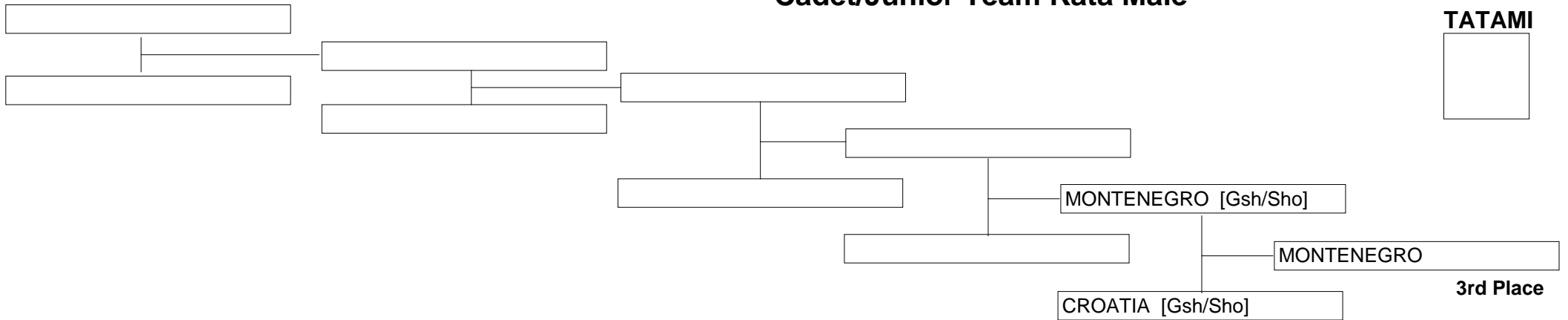



40th EKF Junior&Cadet Karate Champ. 5th Under 21

TURKEY - Konya

8/2/2013 - 10/2/2013

TUR630 B.TURAN [6]
ITA333 C.ZUANON [2]
POR231 A.ALMEIDA []
<BYE>
BUL292 L.RUSCHEVA [2]
BIH235 A.FISIC [3]
SLO247 L.PUSNIK []
<BYE>
ENG265 K.KARWACINSKI [1]
CRO264 S.SIROVICA [2]
SVK274 D.TATAROVA []
<BYE>
UKR222 I.GADYATSKAYA [1]
NED193 L.VOGELZANG [4]
MNE253 D.KONJEVIC []
<BYE>
RUS450 S.KOTAEVA [0]
FIN176 H.KUUSISTO [6]
AUT190 A.BUCHINGER []
<BYE>
GER336 L.RIBGUTH [1]
FRA357 A.AGIER [0]
HUN187 N.BARTHA []
<BYE>
FYR457 S.JOVANOVA [0]
BEL203 L.DEBATTY [4]
SRB421 T.POKRAJAC []
<BYE>
SUI218 R.BRUEDERLIN []
<BYE>
SCO173 I.FROST []
<BYE>

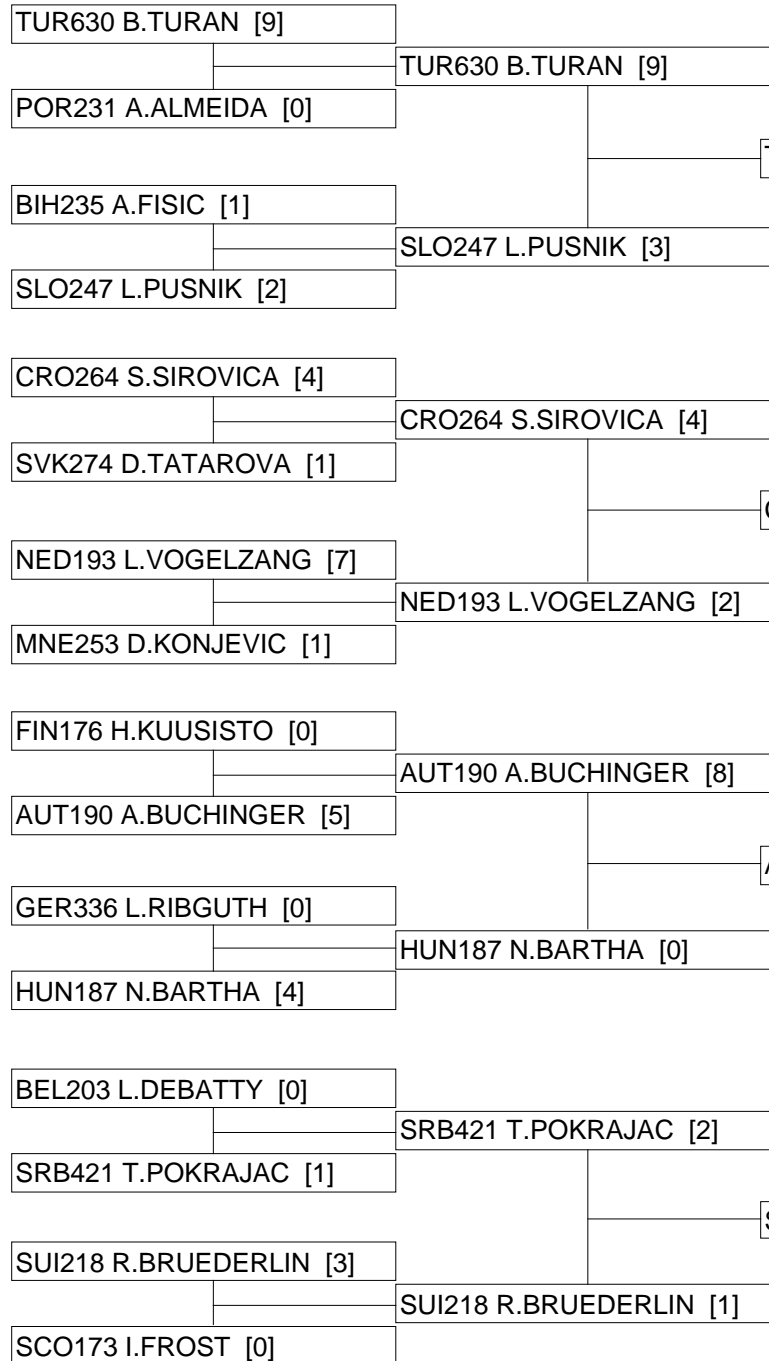

Under 21 Kumite Female 60+ kg

Entries: 23

Pool 1

TATAMI

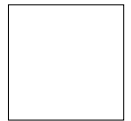

TATAMI

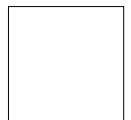

Pool 2

Under 21 Kumite Female 60+ kg



40th EKF Junior&Cadet Karate Champ. 5th Under 21

TURKEY - Konya

8/2/2013 - 10/2/2013

Under 21 Kumite Female 60+ kg

Repechage Pool 1

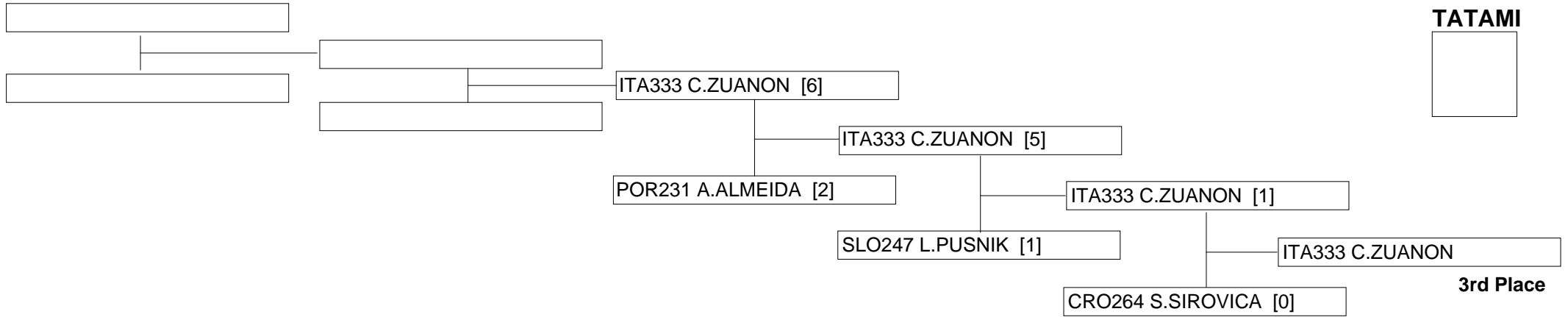

Repechage Pool 2

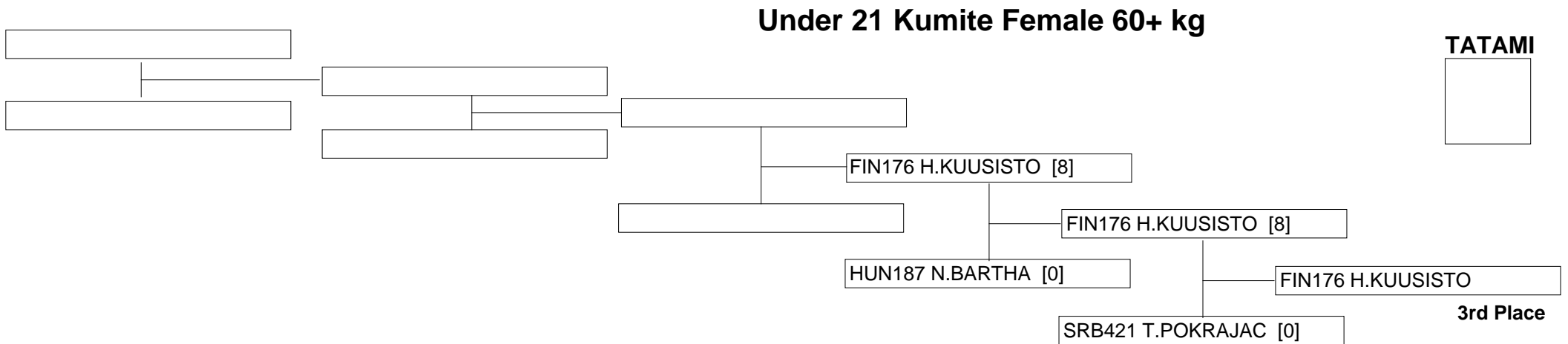



40th EKF Junior&Cadet Karate Champ. 5th Under 21

TURKEY - Konya

8/2/2013 - 10/2/2013

CYR178 M.CHARALAMBUS [0]
AZE261 N.ALIYEVA [3]
SLO222 T.BERTONCELJ [0]
AUT191 B.PLANK [4]
RUS374 N.KADZOVA [4]
IRL137 R.EARLEY [0]
GRE329 M.ARGIANZI []
<BYE>
FYR250 T.BOSKOSKA [2]
GER420 M.ATAKLI [3]
SVK277 Z.SCHWARTZOVA []
<BYE>
ITA263 A.HASANI [2]
FRA356 L.CRUAUX [0]
MNE155 A.DRASKOVIC []
<BYE>
SCO171 A.CONNELL [4]
BEL189 N.OTTEN [1]
LUX124 J.WARLING []
<BYE>
BLR208 A.VIATKINA [8]
BIH236 A.ADILOVIC [0]
HUN193 N.JUHASZ []
<BYE>
SRB180 J.PETROV [6]
NOR146 B.ALSTADSAETHER
TUR336 N.CALISKAN []
<BYE>
POR204 A.CAMPOS [0]
CRO359 I.CANADIJA [8]
UKR257 D.MARCHUK []
<BYE>

AZE261 N.ALIYEVA [0]
AUT191 B.PLANK [3]
AUT191 B.PLANK [8]
RUS374 N.KADZOVA [3]
RUS374 N.KADZOVA [0]
GRE329 M.ARGIANZI [0]
GER420 M.ATAKLI [0]
SVK277 Z.SCHWARTZOVA [0]
SVK277 Z.SCHWARTZOVA [3]
ITA263 A.HASANI [3]
ITA263 A.HASANI [0]
MNE155 A.DRASKOVIC [1]
SCO171 A.CONNELL [0]
LUX124 J.WARLING [8]
LUX124 J.WARLING [8]
BLR208 A.VIATKINA [0]
HUN193 N.JUHASZ [0]
HUN193 N.JUHASZ [8]
SRB180 J.PETROV [0]
TUR336 N.CALISKAN [2]
TUR336 N.CALISKAN [4]
CRO359 I.CANADIJA [1]
UKR257 D.MARCHUK [0]
UKR257 D.MARCHUK [6]

Under 21 Kumite Female -53 kg

Entries: 25



Pool 1

TATAMI

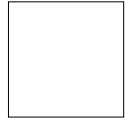

TATAMI

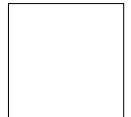

Pool 2

Under 21 Kumite Female -53 kg



40th EKF Junior&Cadet Karate Champ. 5th Under 21

TURKEY - Konya

8/2/2013 - 10/2/2013

Under 21 Kumite Female -53 kg

Repechage Pool 1

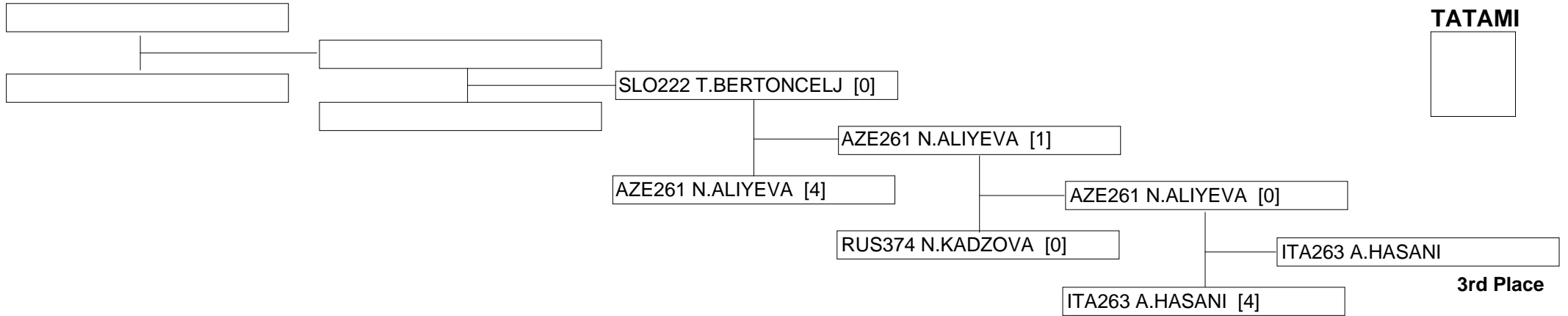

Repechage Pool 2

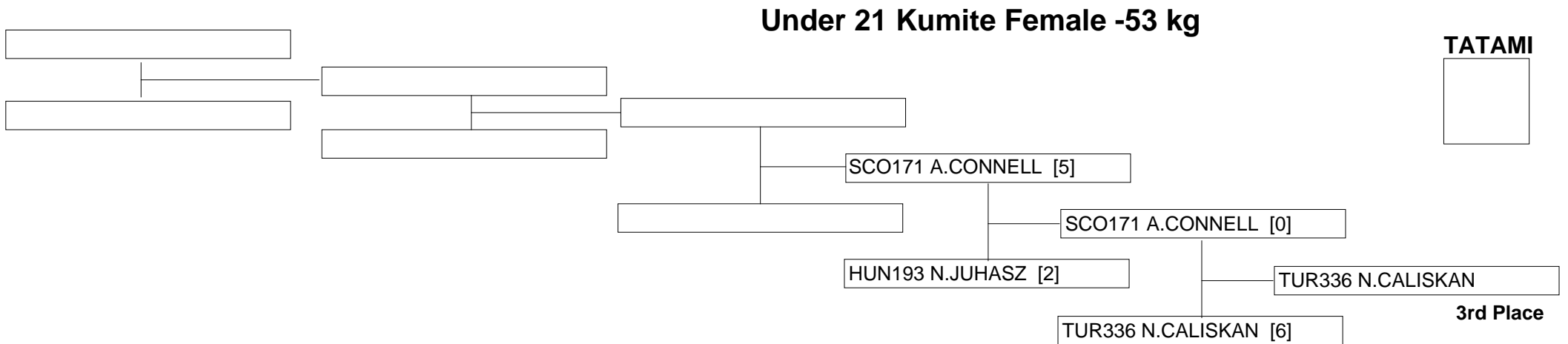



40th EKF Junior&Cadet Karate Champ. 5th Under 21

TURKEY - Konya

8/2/2013 - 10/2/2013

Under 21 Kumite Female -60 kg

Repechage Pool 1

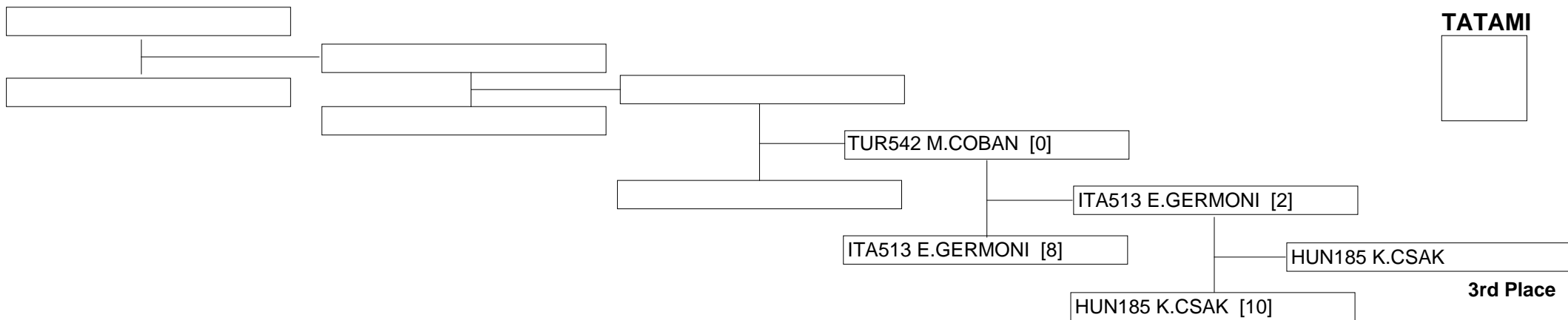

Repechage Pool 2

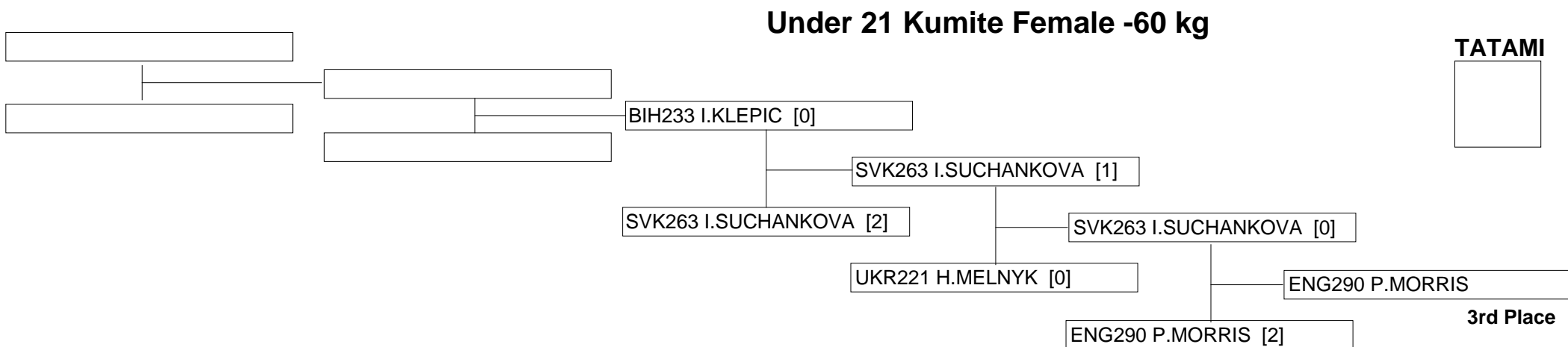



40th EKF Junior&Cadet Karate Champ. 5th Under 21

TURKEY - Konya

8/2/2013 - 10/2/2013

Under 21 Kumite Male 78+ kg

Entries: 26

LAT200 D.SPRINGIS [4]
TUR342 R.KAPTAN [1]
SRB176 A.SESEKOV [8]
CRO255 A.MRVICIC [0]
BUL338 R.BOBEV [0]
ESP333 V.ARANGUREN HERR
MNE151 V.SUKOVIC []
<BYE>
FRA304 J.LAUGIER [8]
POR238 J.CASTRO [0]
NED176 A.CREEMERS []
<BYE>
ITA510 N.ARMANELLI [7]
AUT256 A.PALACKIC [3]
BIH265 A.DAUTOVIC []
<BYE>
GER485 A.HANSER [8]
SLO214 D.RIHTARIC [0]
SVK270 A.LIESKOVSKY [2]
GRE241 D.MOULAVASILIS [4]
RUS351 M.DAVYDOV [8]
ENG264 J.FARRAND [2]
DEN171 C.BECH-HOLM []
<BYE>
SUI249 S.DE MARTIN [0]
HUN209 A.PELLER [4]
AZE201 A.GURBANLI []
<BYE>
BEL173 J.MULOLO [2]
CYR170 S.ZEVLARIS [5]
FYR243 B.JAKUPI []
<BYE>

LAT200 D.SPRINGIS [0]
SRB176 A.SESEKOV [3]
SRB176 A.SESEKOV [2]
ESP333 V.ARANGUREN HERR
ESP333 V.ARANGUREN HERR
MNE151 V.SUKOVIC [1]
FRA304 J.LAUGIER [3]
FRA304 J.LAUGIER [0]
NED176 A.CREEMERS [0]
ITA510 N.ARMANELLI [0]
BIH265 A.DAUTOVIC [3]
BIH265 A.DAUTOVIC [5]
GER485 A.HANSER [4]
GRE241 D.MOULAVASILIS [0]
GRE241 D.MOULAVASILIS [5]
RUS351 M.DAVYDOV [3]
RUS351 M.DAVYDOV [2]
DEN171 C.BECH-HOLM [1]
HUN209 A.PELLER [0]
AZE201 A.GURBANLI [0]
AZE201 A.GURBANLI [2]
CYR170 S.ZEVLARIS [0]
FYR243 B.JAKUPI [5]
FYR243 B.JAKUPI [7]

ESP333 V.ARANGUREN HERR

ESP333 V.ARANGUREN HERR

ESP333 V.ARANGUREN HERR

BIH265 A.DAUTOVIC [2]

BIH265 A.DAUTOVIC [3]

FYR243 B.JAKUPI

RUS351 M.DAVYDOV []

RUS351 M.DAVYDOV [2]

FYR243 B.JAKUPI [2]

AZE201 A.GURBANLI [0]

FYR243 B.JAKUPI []

Under 21 Kumite Male 78+ kg

Pool 1

TATAMI

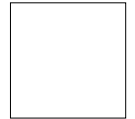

TATAMI

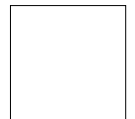

Pool 2



40th EKF Junior&Cadet Karate Champ. 5th Under 21

TURKEY - Konya

8/2/2013 - 10/2/2013

Under 21 Kumite Male 78+ kg

Repechage Pool 1

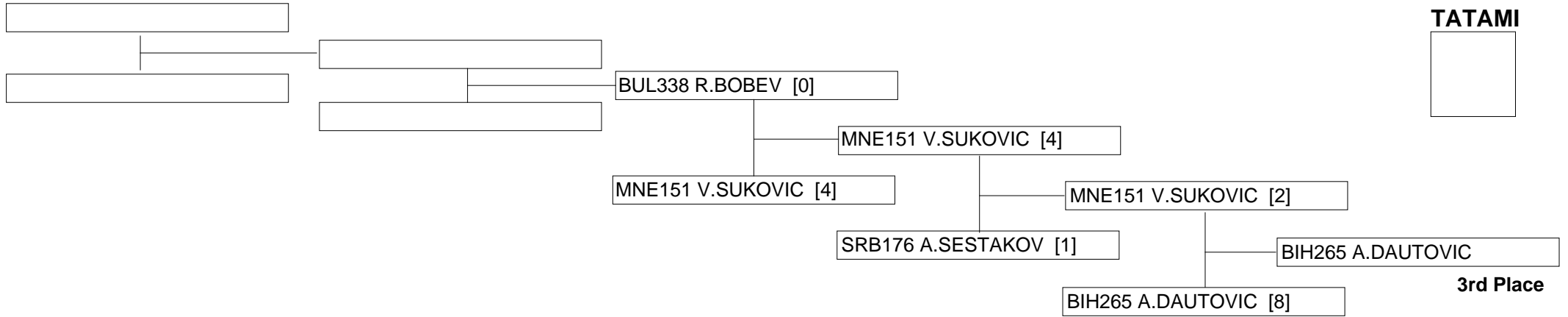

Repechage Pool 2

Under 21 Kumite Male 78+ kg

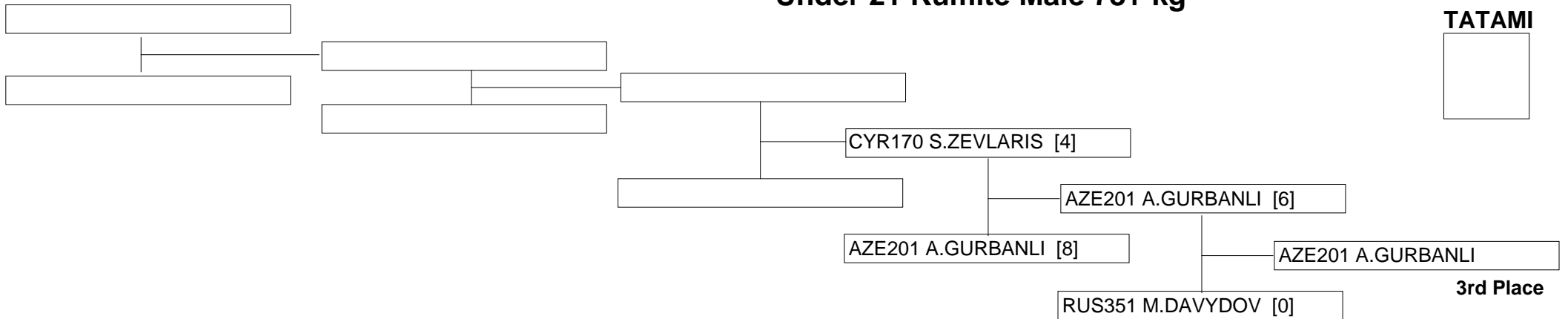



40th EKF Junior&Cadet Karate Champ. 5th Under 21

TURKEY - Konya

8/2/2013 - 10/2/2013

Under 21 Kumite Male -68 kg

TATAMI





40th EKF Junior&Cadet Karate Champ. 5th Under 21

TURKEY - Konya

8/2/2013 - 10/2/2013

Under 21 Kumite Male -68 kg

Entries: 33

SUI263 M.BYTYCI [0]
HUN189 Z.KOHEGYI [1]
NED187 X.KOHLLEN []
<BYE>
CRO325 M.RUKAVINA []
<BYE>
IRL139 J.MC FADDEN []
<BYE>
LAT206 N.BODROVS []
<BYE>
FYR353 I.TASHOV []
<BYE>
BUL213 V.DIMITROV []
<BYE>
MNE276 V.JOVIC []
<BYE>
AUT236 J.FLEISCH []
<BYE>
DEN183 C.OLSEN []
<BYE>
FIN177 J.KOLARI []
<BYE>
BIH230 S.TABAKOVIC []
<BYE>
AZE210 T.AGHALARZADE []
<BYE>
ISR148 S.TAMIR []
<BYE>
BEL184 Y.RODRIGUEZ MERIN
<BYE>
GEO159 D.PATARIDZE []
<BYE>



Pool 1

TATAMI

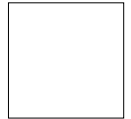

TATAMI

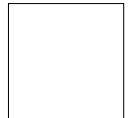

Under 21 Kumite Male -68 kg



40th EKF Junior&Cadet Karate Champ. 5th Under 21

TURKEY - Konya

8/2/2013 - 10/2/2013

Under 21 Kumite Male -68 kg

Entries: 33

Pool 2

TATAMI

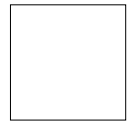

TATAMI

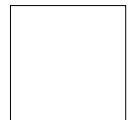

TUR352 E.CEVAHIR []
<BYE>
GER291 K.BEHRENDT []
<BYE>
ITA266 A.CRESCENZO []
<BYE>
GRE233 M.GIANNELIS []
<BYE>
SVK267 R.DOBROTKA []
<BYE>
POR209 V.CERTAN []
<BYE>
UKR275 O.FILIPOVYCH []
<BYE>
FRA293 M.GARIN []
<BYE>
SCO172 G.KELLY []
<BYE>
ESP331 D.FANDOS SONEN []
<BYE>
SLO275 J.BLATNIK []
<BYE>
RUS381 E.PLAKHUTIN []
<BYE>
NOR147 H.FJELDSTAD []
<BYE>
ENG308 J.THOMAS []
<BYE>
WAL139 J.HARRIS []
<BYE>
EST174 M.PAHKLAMAGI []
<BYE>



Under 21 Kumite Male -68 kg



40th EKF Junior&Cadet Karate Champ. 5th Under 21

TURKEY - Konya

8/2/2013 - 10/2/2013

Under 21 Kumite Male -68 kg

Repechage Pool 1

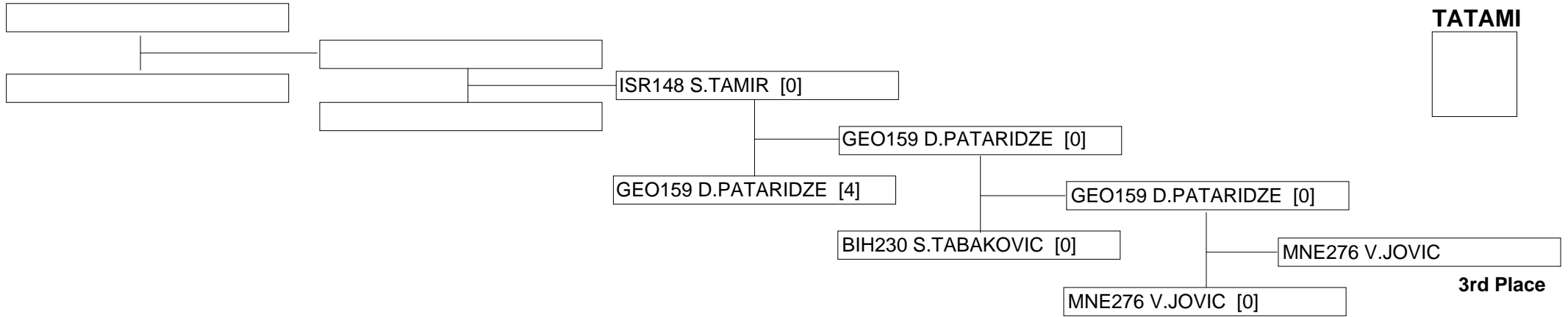

Repechage Pool 2

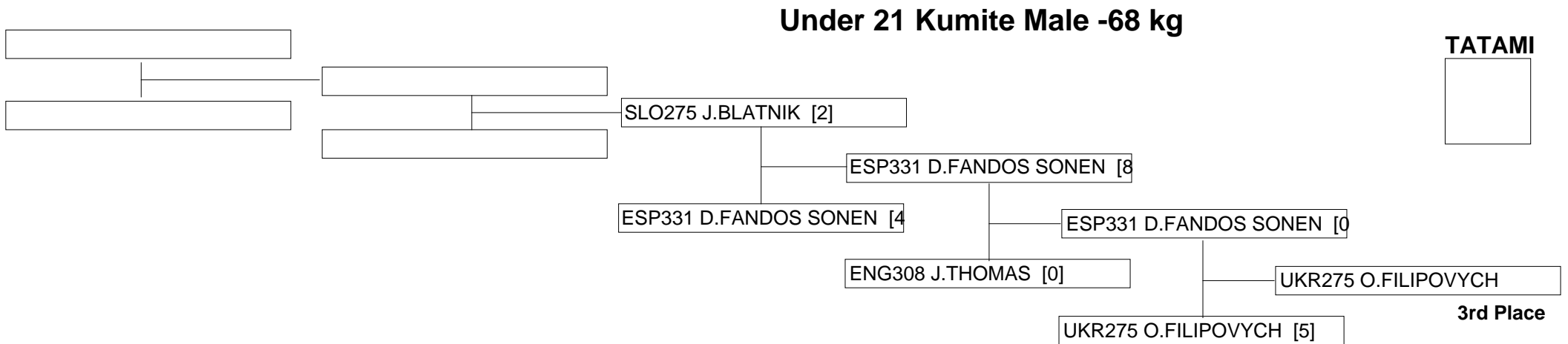



40th EKF Junior&Cadet Karate Champ. 5th Under 21

TURKEY - Konya

8/2/2013 - 10/2/2013

Under 21 Kumite Male -78 kg

TATAMI



TUR301 E.ELTEMUR [3]

TUR301 E.ELTEMUR

ITA268 E.SARNATARO [2]



40th EKF Junior&Cadet Karate Champ. 5th Under 21

TURKEY - Konya

8/2/2013 - 10/2/2013

Under 21 Kumite Male -78 kg

Entries: 34

ALB149 M.NDOJ [1]
SUI207 F.STUTZ [3]
MNE177 A.LICINA []
<BYE>
FYR362 E.KJOSOVIKJ []
<BYE>
CYR181 P.LOIZIDES []
<BYE>
GRE306 N.KOSMAS []
<BYE>
HUN199 D.MOLNAR []
<BYE>
SRB247 U.MIJALKOVIC []
<BYE>
NED196 O.ARSLAN []
<BYE>
ESP429 R.IBANEZ []
<BYE>
EST192 M.LIIVAKANT []
<BYE>
LAT205 M.LUPIKS []
<BYE>
POR240 H.FARINHA []
<BYE>
DEN165 M.MEISNER []
<BYE>
TUR301 E.ELTEMUR []
<BYE>
BLR194 D.KURHAN []
<BYE>
AUT219 I.VESELCIC []
<BYE>



Pool 1

TATAMI

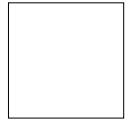

TATAMI

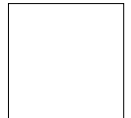

Under 21 Kumite Male -78 kg



40th EKF Junior&Cadet Karate Champ. 5th Under 21

TURKEY - Konya

8/2/2013 - 10/2/2013

Under 21 Kumite Male -78 kg

Entries: 34

FRA430 A.BOUJAABA [5]
ARM130 A.AVOYAN [1]
ENG281 T.HICKMAN []
<BYE>
AZE234 P.ABDULLAYEV []
<BYE>
UKR227 O.ROZENBERG []
<BYE>
ISR167 M.KUTT []
<BYE>
SCO187 M.MACAULAY []
<BYE>
RUS474 D.DENISENKO []
<BYE>
BUL208 S.PETKOV []
<BYE>
GEO151 G.JIKIA []
<BYE>
SVK257 M.LIESKOVSKY []
<BYE>
GER506 S.PROKOP []
<BYE>
SLO216 J.MARKAC []
<BYE>
AND128 S.HERVER []
<BYE>
BIH348 D.GOGIC []
<BYE>
CRO377 D.RUKAVEC []
<BYE>
ITA268 E.SARNATARO []
<BYE>



Pool 2

TATAMI

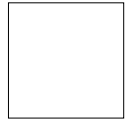

TATAMI

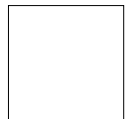

Under 21 Kumite Male -78 kg

