



WORLD KARATE
FEDERATION



RESULTS BOOK

EKF JUNIOR, CADET & U21 CHAMPIONSHIPS 2026 -
LIMASSOL

2026.02.06 - 2026.02.08

SPYROS KYPRIANOU ATHLETIC CENTER, LIMSASSOL

CYPRUS, CYP

TABLE OF CONTENTS

NUMBER OF ENTRIES	5
NUMBER OF ENTRIES BY CONTINENT	7
ENTRYLIST	10
STATISTICS	39
CADET KATA FEMALE	41
CADET KATA MALE	50
CADET KUMITE FEMALE -47 KG	59
CADET KUMITE FEMALE -54 KG	68
CADET KUMITE FEMALE -61 KG	77
CADET KUMITE FEMALE 61+ KG	86
CADET KUMITE MALE -52 KG	95
CADET KUMITE MALE -57 KG	104
CADET KUMITE MALE -63 KG	113
CADET KUMITE MALE -70 KG	122
CADET KUMITE MALE 70+ KG	131
JUNIOR KATA FEMALE	141
JUNIOR KATA MALE	150
JUNIOR KUMITE FEMALE -48 KG	159
JUNIOR KUMITE FEMALE -53 KG	168
JUNIOR KUMITE FEMALE -59 KG	177
JUNIOR KUMITE FEMALE -66 KG	186
JUNIOR KUMITE FEMALE 66+ KG	195
JUNIOR KUMITE MALE -55 KG	204
JUNIOR KUMITE MALE -61 KG	213
JUNIOR KUMITE MALE -68 KG	222
JUNIOR KUMITE MALE -76 KG	231
JUNIOR KUMITE MALE 76+ KG	240
KATA TEAM CADET AND JUNIOR FEMALE	249
KATA TEAM CADET AND JUNIOR MALE	260

U21 KATA FEMALE.....	269
U21 KATA MALE.....	279
U21 KATA TEAM FEMALE.....	288
U21 KATA TEAM MALE.....	295
U21 KUMITE FEMALE -50 KG.....	303
U21 KUMITE FEMALE -55 KG.....	312
U21 KUMITE FEMALE -61 KG.....	321
U21 KUMITE FEMALE -68 KG.....	330
U21 KUMITE FEMALE 68+ KG.....	339
U21 KUMITE MALE -60 KG.....	348
U21 KUMITE MALE -67 KG.....	357
U21 KUMITE MALE -75 KG.....	366
U21 KUMITE MALE -84 KG.....	375
U21 KUMITE MALE 84+ KG.....	385
OFFICIAL RESULTS.....	395
MEDAL STANDING.....	406

NUMBER OF ENTRIES



EKF Junior, Cadet & U21 Championships 2026 - Lim ..

CYPRUS
Spyros Kyprianou Athletic Center, Limsassol

2026.02.06 - 2026.02.08



NUMBER OF ENTRIES

#	Code	National Federation	Male Entries	Female Entries	Total Entries	Total Athletes
1		ALB ALBANIA	11	3	14	14
2		ARM ARMENIA	13	1	14	14
3		AUT AUSTRIA	12	8	20	21
4		AZE AZERBAIJAN	16	12	28	28
5		BEL BELGIUM	9	5	14	14
6		BIH BOSNIA AND HERZEGOVINA	17	16	33	33
7		BUL BULGARIA	16	11	27	26
8		CRO CROATIA	20	18	38	43
9		CYP CYPRUS	18	15	33	33
10		CZE CZECH REPUBLIC	14	15	29	31
11		DEN DENMARK	12	14	26	26
12		ENG ENGLAND	13	14	27	27
13		EST ESTONIA	6	7	13	13
14		FIN FINLAND	5	5	10	10
15		FRA FRANCE	20	18	38	43
16		GEO GEORGIA	13	9	22	22
17		GER GERMANY	19	19	38	44
18		GRE GREECE	18	18	36	36
19		HUN HUNGARY	12	16	28	30
20		ISL ICELAND	5	1	6	5
21		IRL IRELAND	13	9	22	21
22		ISR ISRAEL	16	7	23	25
23		ITA ITALY	20	19	39	48
24		LAT LATVIA	12	10	22	22
25		LTU LITHUANIA	8	9	17	17
26		LUX LUXEMBOURG	8	12	20	20
27		MLT MALTA	4	7	11	11
28		MDA MOLDOVA, REPUBLIC OF	8	3	11	11
29		MNE MONTENEGRO	17	16	33	34
30		NED NETHERLANDS	12	6	18	18
31		MKD NORTH MACEDONIA	17	17	34	36
32		NOR NORWAY	3	6	9	9
33		POL POLAND	17	17	34	38
34		POR PORTUGAL	19	15	34	36
35		ROU ROMANIA	18	17	35	35
36		SCO SCOTLAND	9	6	15	15
37		SRB SERBIA	19	16	35	40
38		SVK SLOVAKIA	19	18	37	40
39		SLO SLOVENIA	7	11	18	20
40		ESP SPAIN	20	19	39	45
41		SWE SWEDEN	12	9	21	21
42		SUI SWITZERLAND	16	12	28	28
43		UKR UKRAINE	19	17	36	36
44		WAL WALES	4	3	7	7
45		WKF-1 WKF-1	18	18	36	41



EKF Junior, Cadet & U21 Championships 2026 - Lim ..

CYPRUS
Spyros Kyprianou Athletic Center, Limsassol

2026.02.06 - 2026.02.08



NUMBER OF ENTRIES

#	Code	National Federation	Male Entries	Female Entries	Total Entries	Total Athletes
46	WKF WKF-2	WKF-2	3	5	8	8
Totals:			607	529	1136	1195



NUMBER OF ENTRIES BY NATIONAL FEDERATION AND CONTINENT



EKF Junior, Cadet & U21 Championships 2026 - Limassol

As of 8 FEB 2026

Code	Continent / National Federation	Male Entries	Female Entries	Total Entries	Total Athletes
	EUROPE				
ALB	ALBANIA	11	3	14	14
ARM	ARMENIA	13	1	14	14
AUT	AUSTRIA	12	8	20	21
AZE	AZERBAIJAN	16	12	28	28
BEL	BELGIUM	9	5	14	14
BIH	BOSNIA AND HERZEGOVINA	17	16	33	33
BUL	BULGARIA	16	11	27	26
CRO	CROATIA	20	18	38	43
CYP	CYPRUS	18	15	33	33
CZE	CZECH REPUBLIC	14	15	29	31
DEN	DENMARK	12	14	26	26
ENG	ENGLAND	13	14	27	27
EST	ESTONIA	6	7	13	13
FIN	FINLAND	5	5	10	10
FRA	FRANCE	20	18	38	43
GEO	GEORGIA	13	9	22	22
GER	GERMANY	19	19	38	44
GRE	GREECE	18	18	36	36
HUN	HUNGARY	12	16	28	30
ISL	ICELAND	5	1	6	5
IRL	IRELAND	13	9	22	21
ISR	ISRAEL	16	7	23	25
ITA	ITALY	20	19	39	48
LAT	LATVIA	12	10	22	22
LTU	LITHUANIA	8	9	17	17
LUX	LUXEMBOURG	8	12	20	20
MLT	MALTA	4	7	11	11
MDA	MOLDOVA, REPUBLIC OF	8	3	11	11
MNE	MONTENEGRO	17	16	33	34
NED	NETHERLANDS	12	6	18	18
MKD	NORTH MACEDONIA	17	17	34	36
NOR	NORWAY	3	6	9	9
POL	POLAND	17	17	34	38
POR	PORTUGAL	19	15	34	36
ROU	ROMANIA	18	17	35	35
SCO	SCOTLAND	9	6	15	15
SRB	SERBIA	19	16	35	40
SVK	SLOVAKIA	19	18	37	40



NUMBER OF ENTRIES BY NATIONAL FEDERATION AND CONTINENT



EKF Junior, Cadet & U21 Championships 2026 - Limassol

As of 8 FEB 2026

Code	Continent / National Federation	Male Entries	Female Entries	Total Entries	Total Athletes
SLO	SLOVENIA	7	11	18	20
ESP	SPAIN	20	19	39	45
SWE	SWEDEN	12	9	21	21
SUI	SWITZERLAND	16	12	28	28
UKR	UKRAINE	19	17	36	36
WAL	WALES	4	3	7	7
Total	EUROPE	44	586	1,092	1,146
WKF-1	WKF-1	18	18	36	41
WKF-2	WKF-2	3	5	8	8
Total	2	21	23	44	49
Total	46	607	529	1,136	1,195

ENTRYLIST



EKF Junior, Cadet & U21 Championships 2026 - Lim..



ENTRIES BY NATIONAL FEDERATION

As of 8 FEB 2026

Code	ID	Gender	Name	Event	Seeding
ALB	ALB02574	M	BREGU KLESTION	Cadet Kumite Male 70+ kg	
	ALB02277	M	DURBAKU AMAR	Junior Kumite Male 76+ kg	
	ALB02577	M	HASANI NEEVIS	Cadet Kumite Male -52 kg	
	ALB002731	M	HAZIZI ENIS	Junior Kumite Male -61 kg	
	ALB02536	M	HOXHAJ VILSJAN	U21 Kumite Male 84+ kg	
	ALB02271	M	MUCA ARMANDO	Junior Kumite Male -76 kg	
	ALB2221	M	PJETRI ERNIK	U21 Kumite Male -84 kg	
	ALB02464	M	RAMI RIGERS	U21 Kumite Male -67 kg	
	ALB002733	M	RUSTEMI ENDRI	Junior Kumite Male -68 kg	
	ALB02573	M	SELENICA HYSEN	Cadet Kumite Male -70 kg	
	ALB02388	M	TOZAJ TOZO	Cadet Kumite Male -57 kg	
	ALB02267	F	BACKA ISRA	Cadet Kumite Female -61 kg	
	ALB02389	F	DEDEJ AMANDA	Cadet Kumite Female -54 kg	
	ALB002809	F	REXHEPI LANIKA	Cadet Kumite Female 61+ kg	3
ARM	ARM003269	M	ABGARYAN AREN	Cadet Kumite Male 70+ kg	
	ARM003267	M	GASPARYAN EMANUEL	Junior Kumite Male 76+ kg	
	ARM02709	M	GEVORGYAN ALEN	U21 Kumite Male -67 kg	
	ARM02373	M	GRIGORYAN ALEN	Junior Kumite Male -55 kg	
	ARM003062	M	HAKOBYAN GEVORG	Junior Kumite Male -61 kg	
	ARM003270	M	KARAPETYAN ARAM	Cadet Kumite Male -57 kg	
	ARM03008	M	KOSAKYAN SUREN	U21 Kumite Male -84 kg	
	ARM003271	M	MUSHEGHYAN GOR	Cadet Kumite Male -63 kg	
	ARM02374	M	PETROSYAN TARON	Junior Kumite Male -68 kg	
	ARM003260	M	POGHOSYAN DAVIT	Cadet Kata Male	
	ARM003268	M	POGHOSYAN ERIK	Cadet Kumite Male -70 kg	
	ARM02971	M	SARGSYAN NAREK	Cadet Kumite Male -52 kg	
	ARM02638	M	VARDANYAN HOVIK	Junior Kumite Male -76 kg	
	ARM03014	F	DAVTYAN ALVARD	Junior Kumite Female -59 kg	
	AUT	AUT03001	M	BLAGA ALEXANDRU	Cadet Kumite Male -52 kg
AUT02780		M	FLEISCH TOBIAS	Junior Kumite Male -68 kg	
AUT003240		M	HRIHORASHENKO MYKYTA	U21 Kumite Male -75 kg	
AUT02950		M	KLEINEKATHOEFER JAKOB	U21 Kumite Male -84 kg	
AUT02480		M	LANG MARCUS	U21 Kumite Male -60 kg	
AUT03000		M	LIST FABIO	Junior Kata Male	
AUT02781		M	PLATISA PASCAL	Junior Kumite Male -76 kg	3
AUT003121		M	SCHNETZER ERIC	Cadet Kumite Male -63 kg	
AUT02528		M	SELIMOVIC ARMIN	U21 Kumite Male 84+ kg	
AUT02673		M	WAGNER FELIX	U21 Kata Team Male	
AUT02533		M	WU TIMON	U21 Kata Team Male	
AUT02955		M	ZADINA EMIL	Cadet Kata Male	
AUT02600		M	ZOECHLING FLORIAN	U21 Kata Male	4
AUT02600		M	ZOECHLING FLORIAN	U21 Kata Team Male	
AUT02817		F	CETIN CEYLIN	Junior Kumite Female -59 kg	2
AUT003393		F	JEJINIC LEA	Cadet Kumite Female -47 kg	
AUT03005		F	KEMETINGER SARAH	Junior Kumite Female -66 kg	
AUT03002		F	KIRISITS MIRA	Junior Kumite Female -53 kg	



EKF Junior, Cadet & U21 Championships 2026 - Lim..



ENTRIES BY NATIONAL FEDERATION

As of 8 FEB 2026

Code	ID	Gender	Name	Event	Seeding
AUT	AUT02674	F	LEHNER TAMARA	Junior Kata Female	3
	AUT02524	F	SCHUETZE EMMA	U21 Kumite Female 68+ kg	4
	AUT02677	F	SKRIJELJ SARA	U21 Kumite Female -61 kg	
	AUT02961	F	SOPIĆ NOEMI	Cadet Kumite Female -54 kg	
AZE	AZE02911	M	ABASOV RAVAN	Junior Kumite Male -61 kg	
	AZE003639	M	ALIMURADOV NURLAN	Cadet Kumite Male -70 kg	
	AZE02292	M	ALIRZAYEV SALMAN	U21 Kumite Male -67 kg	
	AZE02553	M	AZIM RAHIB	U21 Kumite Male -75 kg	
	AZE02550	M	DOSTUYEV ASLAN	U21 Kumite Male -60 kg	
	AZE02344	M	GANBAROV VUSAL	Junior Kumite Male -55 kg	2
	AZE02700	M	GAYIBOV JAHANGIR	Junior Kumite Male 76+ kg	
	AZE03023	M	GOZALOV AMIN	Cadet Kumite Male -57 kg	
	AZE03350	M	HAJIZADA NURAN	Junior Kumite Male -76 kg	
	AZE02464	M	HASANOV VAHID	U21 Kumite Male 84+ kg	
		M	HASHIMZADA MADAKHIL	Cadet Kata Male	
	AZE03302	M	KAMILOV SHAMO	Cadet Kumite Male 70+ kg	
	AZE02554	M	KARIMZADA NIHAD	U21 Kumite Male -84 kg	
	AZE02606	M	MALIKOV ALADDIN	Junior Kumite Male -68 kg	
	AZE003459	M	RAFIYEV ABULFAZ	Cadet Kumite Male -52 kg	
	AZE02551	M	SALMANOV SALMAN	Junior Kata Male	
	AZE03304	F	AHMADZADA JANSU	Junior Kumite Female -66 kg	
	AZE2234	F	ALIYEVA AYSU	U21 Kumite Female -68 kg	
	AZE003408	F	HAJIYEVA FATMA	Junior Kumite Female -59 kg	
	AZE02563	F	HEYDAROVA RAMILA	U21 Kata Female	
	AZE02546	F	JABRAYILOVA FATIMA	U21 Kumite Female -50 kg	
	AZE003632	F	KAZIMOVA MADINA	Cadet Kumite Female 61+ kg	
	AZE02691	F	MAMADOVA FATIMA	Junior Kumite Female -53 kg	
	AZE03309	F	NAJAFLI DANIZ	Cadet Kumite Female -54 kg	
	AZE02878	F	ORUJOVA GULAY	U21 Kumite Female -61 kg	
	AZE03305	F	SHAHAZARLI FIDAN	Cadet Kumite Female -47 kg	
	AZE03300	F	TARVERDI AYSU	Cadet Kumite Female -61 kg	
	AZE03348	F	ZEYNALOVA MIRANA	Junior Kumite Female -48 kg	
BEL	BEL02291	M	ABDELMALKI AMIN	U21 Kumite Male -60 kg	1
	BEL03142	M	ABDELMALKI YOUSSEF	Junior Kumite Male -55 kg	3
	BEL02532	M	ALVES TORCATO MATHIS	Junior Kumite Male -61 kg	
	BEL02529	M	EJJA AMINE	U21 Kumite Male -67 kg	4
	BEL02580	M	JADOUL ERWAN	U21 Kumite Male 84+ kg	3
	BEL003451	M	MEHADHEBI AMIR	Cadet Kumite Male -57 kg	
	BEL003220	M	TSHIBASSU-SONA ELIE-CHRISTOPHER-ALEX	Junior Kumite Male -76 kg	
	BEL02794	M	ZEKHNINI ACHRAF	U21 Kumite Male -75 kg	
	BEL02528	M	ZOUEINI RAYAN	Junior Kumite Male -68 kg	1
	BEL02332	F	BOUGRINE AMEL	U21 Kumite Female -61 kg	2
	BEL03143	F	MANCA GIULIA	Junior Kata Female	2
	BEL003217	F	POSKIN EMILIE	Cadet Kumite Female -54 kg	2
	BEL03145	F	SRIDI MAISSA	Junior Kumite Female 66+ kg	2
	BEL02896	F	YUKSEKTEPE ASYA	Junior Kumite Female -48 kg	



EKF Junior, Cadet & U21 Championships 2026 - Lim..



ENTRIES BY NATIONAL FEDERATION

As of 8 FEB 2026

Code	ID	Gender	Name	Event	Seeding
BIH	BIH2669	M	ARNAUTOVIC ALI	Junior Kumite Male -76 kg	
	BIH04278	M	DIDIC ISMAIL	Junior Kumite Male -61 kg	
	BIH03720	M	GENJGA SADZID	Cadet Kumite Male -57 kg	
	BIH004819	M	HADZIC OMER	Cadet Kumite Male -63 kg	
	BIH03727	M	JASAREVIC EJMEN	Cadet Kumite Male -70 kg	
	BIH03169	M	JASAREVIC KERIM	U21 Kumite Male -67 kg	
	BIH2573	M	KADRIC FARUK	U21 Kumite Male -60 kg	
	BIH03985	M	KARIC ANIS	Cadet Kata Male	
	BIH03968	M	MUHOVIC DAVUD	Cadet Kumite Male -52 kg	
	BIH04281	M	MUJIC VEDAD	Junior Kumite Male -68 kg	
	BIH03764	M	MUSIC ADIN	Junior Kata Male	
	BIH2455	M	PALJEVAC SINAN	U21 Kumite Male -84 kg	3
	BIH2657	M	RAMIC FARIS	U21 Kata Male	
	BIH2620	M	SMAJIC HARUN	U21 Kumite Male 84+ kg	
	BIH03206	M	SPAHIC BELMIN	Junior Kumite Male 76+ kg	
	BIH2823	M	ZOLOTA ISMAIL	U21 Kumite Male -75 kg	3
	BIH04431	M	ZUNDJA EMIR	Cadet Kumite Male 70+ kg	
	BIH03171	F	ARNAUTOVIC ZAHRA	Cadet Kumite Female -47 kg	
	BIH2637	F	ASCIC SEJLA	Junior Kumite Female -66 kg	
	BIH2805	F	BAHIC ALDINA	Junior Kata Female	
	BIH03704	F	BASAGIC EDNA	Cadet Kata Female	
	BIH03989	F	DOGATOVIC TAMARA	Junior Kumite Female -53 kg	
	BIH005208	F	HADZIC AZRA	Cadet Kumite Female -54 kg	
	BIH03680	F	HUKARA SARA	Cadet Kumite Female -61 kg	
	BIH03794	F	HUSIC DALAL	Cadet Kumite Female 61+ kg	
	BIH004856	F	JAKSIC ALEKSANDRA	U21 Kumite Female -61 kg	
	BIH03291	F	KURTANOVIC AJLIN	Junior Kumite Female 66+ kg	
	BIH2895	F	LEKANIC SELENA	U21 Kumite Female 68+ kg	
	BIH2907	F	MEHANIJA HENA	U21 Kumite Female -55 kg	
	BIH2640	F	MESKOVIC AJLA	U21 Kumite Female -50 kg	
	BIH2604	F	SIPOVIC AJLA	U21 Kumite Female -68 kg	
	BIH2946	F	SIPOVIC EDINA	Junior Kumite Female -59 kg	
	BIH03166	F	ZUKIC ADNA	Junior Kumite Female -48 kg	
BUL	BUL02461	M	APRILOV DENIS	Junior Kata Male	
	BUL02474	M	BOYADZHIEV DIMITAR	Junior Kumite Male -61 kg	
	BUL003186	M	GEORGIEV ADRIAN	Cadet Kumite Male -63 kg	
	BUL2139	M	MATUSKI GEORGI	U21 Kata Male	
	BUL02476	M	MIHAYLOV NIKOLA	Junior Kumite Male -68 kg	
	BUL2306	M	MIHAYLOV PETAR	U21 Kumite Male -67 kg	
	BUL003142	M	MITOV ALEKSANDAR	Cadet Kumite Male -70 kg	
	BUL003090	M	NIKOLOV NIKOLA	Cadet Kata Male	
	BUL003090	M	NIKOLOV NIKOLA	Cadet Kumite Male -52 kg	
	BUL2216	M	SOTIROV BOJIDAR	Junior Kumite Male 76+ kg	
	BUL02471	M	STEFANOV NIKOLAY	U21 Kumite Male -60 kg	
	BUL003048	M	TANEV IOAN	Cadet Kumite Male -57 kg	
	BUL003389	M	TASIM TUNCAY	U21 Kumite Male -84 kg	
	BUL2222	M	TODOROV ISKREN	U21 Kumite Male -75 kg	



EKF Junior, Cadet & U21 Championships 2026 - Lim..



ENTRIES BY NATIONAL FEDERATION

As of 8 FEB 2026

Code	ID	Gender	Name	Event	Seeding
BUL	BUL02621	M	TSANEV NIKOLAY	Junior Kumite Male -76 kg	
	BUL003181	M	VALKOV NIKOLAY	Cadet Kumite Male 70+ kg	
	BUL02967	F	ABULIBDE AMIRA	Junior Kumite Female -66 kg	
	BUL02459	F	BOYADZHIEVA ADRIANA	Junior Kumite Female -59 kg	
	BUL003387	F	DIMITROVA DARIA	Junior Kumite Female 66+ kg	
	BUL003044	F	DINEVA RAYA	Cadet Kumite Female -47 kg	
	BUL003170	F	DONCHEVA GABRIELA	Junior Kumite Female -48 kg	
	BUL003103	F	GEORGIEVA STEFANI	Cadet Kumite Female -61 kg	
	BUL02974	F	KONDOVA MARINA	Junior Kumite Female -53 kg	
	BUL003162	F	LABADA YULIANA	Cadet Kumite Female 61+ kg	
	BUL02757	F	STOYANOVA YOANNA	U21 Kumite Female -61 kg	
	BUL003010	F	TODOROVA ALBENA	Cadet Kumite Female -54 kg	
	BUL2210	F	TSANEVA TEODORA	U21 Kumite Female -50 kg	1
CRO	CRO03454	M	BERMANEC DAVID	Cadet Kumite Male -70 kg	2
	CRO03718	M	BIRAC NIKOLA	Junior Kumite Male -76 kg	2
	CRO03281	M	BRAVARIC CILO DAMJAN	U21 Kata Team Male	
	CRO03709	M	CORDASEV TOMISLAV	Cadet Kumite Male -57 kg	
	CRO03418	M	FAIC DAVID	Kata Team Cadet and Junior Male	
	CRO03418	M	FAIC DAVID	Cadet Kata Male	
	CRO2641	M	FILES MARK	U21 Kata Male	
	CRO2641	M	FILES MARK	U21 Kata Team Male	
	CRO03438	M	FILIPOVIC PETAR	Cadet Kumite Male 70+ kg	
	CRO03422	M	GRGIC OZREN	Junior Kata Male	
	CRO03422	M	GRGIC OZREN	Kata Team Cadet and Junior Male	
	CRO03015	M	HUIC DINO	U21 Kata Team Male	
	CRO03456	M	KOMARAC FILIP	Cadet Kumite Male -63 kg	3
	CRO03388	M	KUKIC IVAN	Kata Team Cadet and Junior Male	
	CRO2811	M	MABIC FILIP	Junior Kumite Male -61 kg	2
	CRO2820	M	MASLOV LOVRO	U21 Kumite Male -60 kg	
	CRO2421	M	MILETA TOMA	U21 Kumite Male -84 kg	4
	CRO03463	M	PANIC TINO	Cadet Kumite Male -52 kg	3
	CRO03461	M	PAPONJA DAVID	Junior Kumite Male -55 kg	
	CRO03130	M	PLESIVCAK MISLAV	U21 Kumite Male 84+ kg	1
	CRO004724	M	SAGI NIKO	Kata Team Cadet and Junior Male	
	CRO03364	M	SLUKIC PETAR	Junior Kumite Male -68 kg	3
	CRO03489	M	SOLTIC ERVIN	Junior Kumite Male 76+ kg	3
	CRO2660	M	STRAHIJA SVEN	U21 Kumite Male -75 kg	
	CRO03240	M	TUSKAN SVEN	U21 Kumite Male -67 kg	
	CRO03085	M	ZEINSKI IVAN	U21 Kata Team Male	
	CRO03358	F	BARUKCIC ANA MARIE	Cadet Kumite Female 61+ kg	2
	CRO03494	F	BESLIJA ELENA	Junior Kumite Female -48 kg	
	CRO03381	F	BRAICA KATJA	Junior Kumite Female -59 kg	
	CRO03367	F	BRLETIC ELENA	Junior Kumite Female -53 kg	
	CRO03725	F	DUDUKOVIC NINA	Junior Kumite Female 66+ kg	
	CRO04174	F	GRABOVAC ERIKA	Kata Team Cadet and Junior Female	
	CRO04167	F	GUDELJ LARA	Kata Team Cadet and Junior Female	
	CRO2883	F	IVANCIC DOROTEA	U21 Kumite Female -50 kg	



EKF Junior, Cadet & U21 Championships 2026 - Lim..



ENTRIES BY NATIONAL FEDERATION

As of 8 FEB 2026

Code	ID	Gender	Name	Event	Seeding
CRO	CRO03442	F	JELCIC ROZA	Cadet Kumite Female -54 kg	
	CRO03813	F	JURCEVIC LARA	Junior Kata Female	
	CRO03813	F	JURCEVIC LARA	Kata Team Cadet and Junior Female	
	CRO03132	F	KLARIC KORINA	U21 Kumite Female -61 kg	
	CRO2838	F	LUKENDA NINA	U21 Kumite Female -68 kg	
	CRO03588	F	PANIC PAULA	Cadet Kumite Female -61 kg	1
	CRO2968	F	PRGA PATRICIJA	U21 Kumite Female -55 kg	4
	CRO04172	F	RAJKOVIC ENA	Kata Team Cadet and Junior Female	
	CRO004263	F	SABOL MIA	Cadet Kata Female	
	CRO03371	F	SEGAVCIC KATIA	U21 Kata Female	
	CRO03447	F	SKITARELIC GABI	Cadet Kumite Female -47 kg	
	CRO2818	F	STRAHIJA LAURA	Junior Kumite Female -66 kg	
	CRO2841	F	TOMIC SARA	U21 Kumite Female 68+ kg	
	CYP	CYP02813	M	ANDREOU CHRISTAKIS	Junior Kumite Male -55 kg
CYP02832		M	ANTONIOU IOEL	Junior Kumite Male -68 kg	
CYP02826		M	ANTONIOU NIKOLAS	Junior Kumite Male -76 kg	
CYP2336		M	CHARALAMBIDES STAVROS ALEXANDROS	U21 Kumite Male -75 kg	
CYP003349		M	CHARALAMBOUS ALEXIS	Cadet Kata Male	
CYP003282		M	CHI ADAMOS	Cadet Kumite Male -63 kg	
CYP2327		M	CONSTANTINOU PANAGIOTIS	U21 Kumite Male -84 kg	
CYP02822		M	EFTHYMIU CHRISTOS	Junior Kata Male	
CYP03096		M	EFTHYMIU CONSTANTINOS	Cadet Kumite Male -52 kg	
CYP2206		M	GAVRIEL ANDREAS	U21 Kumite Male -60 kg	
CYP003358		M	HADJIHARALAMBOUS CHRISTODOULOS	Cadet Kumite Male 70+ kg	
CYP003220		M	NICODIMOU NEOFYTOS	Cadet Kumite Male -70 kg	
CYP03049		M	NIKOLAOU GIORGOS	Junior Kumite Male -61 kg	
CYP003239		M	PAFITIS CHRISTOS	Cadet Kumite Male -57 kg	
CYP2207		M	SOBAKIN ALEXANDROS	U21 Kumite Male 84+ kg	
CYP02842		M	THEMISTOKLEOUS CHARALAMPOS	Junior Kumite Male 76+ kg	
CYP2342		M	TSANGARAS ALEXIS	U21 Kumite Male -67 kg	
CYP02820		M	VOUZOUNIS PANTELIS	U21 Kata Male	
CYP02821		F	ARTEMI KONSTANTINA	Junior Kumite Female -59 kg	
CYP02840		F	DALITI IOULIA	Junior Kumite Female -53 kg	
CYP02769		F	DEMETRIOU CHARA	U21 Kumite Female 68+ kg	
CYP02829		F	EFSTATHIOU KONSTANTINA	Junior Kumite Female -48 kg	3
CYP03098		F	EFTHYMIU VALERIA	Cadet Kumite Female 61+ kg	
CYP03110		F	KARAYIANNIDOU ATHINA IOANNA	Junior Kata Female	
CYP03112		F	KATSANTONI ZOE	Cadet Kumite Female -54 kg	
CYP003357		F	KLEANTHOS ARETI	Cadet Kumite Female -47 kg	
CYP02730		F	KYPRIANOU MARIA	U21 Kumite Female -55 kg	
CYP03094		F	KYRIAKOU STAVRI	Junior Kumite Female -66 kg	
CYP02746		F	MICHAELIDOU ANNA	Junior Kumite Female 66+ kg	
CYP003241		F	NICOLAOU KALLIOPI	Cadet Kata Female	
CYP02931		F	PAPAPHILIPPOU KONSTANTINA	U21 Kata Female	
CYP02925		F	PRIGKIPA ATHENA	U21 Kumite Female -68 kg	
CYP03093		F	TUTIC HANA	Cadet Kumite Female -61 kg	



EKF Junior, Cadet & U21 Championships 2026 - Lim..



ENTRIES BY NATIONAL FEDERATION

As of 8 FEB 2026

Code	ID	Gender	Name	Event	Seeding
CZE	CZE003005	M	BRZOBOHATY MICHAL	Junior Kata Male	
	CZE02481	M	DUB DANIEL	U21 Kumite Male -67 kg	
	CZE003003	M	FAJT JAKUB	Junior Kumite Male -76 kg	
	CZE02427	M	HARVILKO SIMON	Junior Kumite Male -55 kg	
	CZE02420	M	HORNAK FILIP	Junior Kumite Male -61 kg	
	CZE02712	M	ILCIK ADAM	Cadet Kata Male	
	CZE02348	M	LINHART JOSEF	U21 Kumite Male -60 kg	
	CZE02750	M	PALAN MARTIN	Junior Kumite Male 76+ kg	
	CZE02492	M	SIMOTA DAVID	Junior Kumite Male -68 kg	
	CZE02738	M	SNAJDR STEPAN	U21 Kumite Male -75 kg	
	CZE02713	M	SPANIK TOBIAS	Cadet Kumite Male -57 kg	2
	CZE02843	M	SUPKA TOBIAS	Cadet Kumite Male -70 kg	
	CZE003149	M	VITASEK LUKAS	Cadet Kumite Male 70+ kg	
	CZE02259	M	ZLABEK JAKUB	U21 Kata Male	
	CZE02436	F	BUKOVSKA LUCIE	Junior Kumite Female -66 kg	
	CZE02248	F	HAKOVA AMALIE	U21 Kumite Female 68+ kg	
	CZE02268	F	HRDLICKOVA LUCY	U21 Kumite Female -55 kg	
	CZE02716	F	KASIK KLAUDIA	Cadet Kumite Female 61+ kg	
	CZE02423	F	KIRSCHNEROVA ALICE-JANA	U21 Kata Female	2
	CZE02423	F	KIRSCHNEROVA ALICE-JANA	U21 Kata Team Female	
	CZE02479	F	KLEWAROVA MARKETA	Junior Kumite Female 66+ kg	
	CZE02535	F	KUBINOVA ANNA	Junior Kata Female	
	CZE02434	F	MALA DANIELA	U21 Kumite Female -50 kg	
	CZE02610	F	MALAFOVA NATALIE	U21 Kata Team Female	
	CZE02477	F	NOVAKOVA KATERINA	U21 Kata Team Female	
	CZE02247	F	ONDROUSKOVA AMALIE	U21 Kata Team Female	
	CZE003195	F	POSKEROVA NELA	Junior Kumite Female -59 kg	
	CZE02424	F	PRIGLOVA MARIE	U21 Kumite Female -61 kg	
	CZE003148	F	SEVCOVA BARBORA	Cadet Kumite Female -47 kg	
	CZE003194	F	SIMPSON LILIANA	Cadet Kumite Female -61 kg	
	CZE003001	F	SVOBODOVA ELISKA	Cadet Kumite Female -54 kg	
	CZE02253	F	TINAVSKA EMA	U21 Kumite Female -68 kg	3
DEN	DEN003044	M	EMINOVSKI SEMIH	Cadet Kumite Male -63 kg	
	DEN003043	M	FAGERLUND NYMARK WILLIAM	Cadet Kumite Male -52 kg	
	DEN02638	M	HOULBERG MEJLHEDE LUCAS	U21 Kumite Male 84+ kg	
	DEN02570	M	KALLESTRUP MARIUS	U21 Kumite Male -60 kg	
	DEN02642	M	KJAER POULSEN ALVIN	U21 Kumite Male -75 kg	
	DEN002998	M	KRISTENSEN ELIAS MAITSLAND	Junior Kumite Male -55 kg	
	DEN02456	M	KRISTENSEN HAILEMICHAEL	U21 Kumite Male -67 kg	
	DEN003000	M	PEJTERSEN EMIL MARKMANN	Junior Kumite Male 76+ kg	
	DEN002999	M	PEJTERSEN JOHAN MARKMANN	Junior Kumite Male -76 kg	
	DEN02842	M	PETERSEN LUKAS MURAKAMI	Junior Kata Male	
	DEN002954	M	UDAHL MATHIAS EK	Junior Kumite Male -68 kg	
	DEN02568	M	VEISTRUP DAVID	U21 Kata Male	
	DEN02466	F	BATH ASTAMAJA	U21 Kumite Female 68+ kg	
	DEN003040	F	BISGAARD IDA	Cadet Kumite Female -61 kg	
	DEN02569	F	BOHNHOF KARLA	U21 Kumite Female -61 kg	



EKF Junior, Cadet & U21 Championships 2026 - Lim..



ENTRIES BY NATIONAL FEDERATION

As of 8 FEB 2026

Code	ID	Gender	Name	Event	Seeding
DEN	DEN002995	F	BONDERUP ALBERTE	Junior Kumite Female -66 kg	
	DEN02841	F	DAHL-WROENDING JUSTINA	U21 Kata Female	
	DEN003003	F	EMDE SARA	Junior Kata Female	
	DEN02706	F	HENRIKSEN VANESSA	U21 Kumite Female -68 kg	
	DEN002957	F	HVITVED-ARNESEN AMALIE	Junior Kumite Female 66+ kg	
	DEN003042	F	JOERGENSEN KARLA ROSGAARD	U21 Kumite Female -55 kg	
	DEN003041	F	LY ISABELLA	Junior Kumite Female -53 kg	
	DEN002949	F	MALTE BAKKE CAMMA	Cadet Kata Female	
	DEN003039	F	POULSEN JO KJAER	Cadet Kumite Female -54 kg	
	DEN002953	F	SOENDERGAARD HANNAH BATH	Junior Kumite Female -59 kg	1
	DEN002996	F	SOENDERGAARD SOFIA BATH	U21 Kumite Female -50 kg	
ENG	ENG02909	M	BARTOLETTA DANIEL	U21 Kumite Male -67 kg	
	ENG03248	M	COOPER-DALLEY JOSEPH	U21 Kumite Male -75 kg	
	ENG003606	M	FAYIK LOUIE	Junior Kumite Male -76 kg	
	ENG003608	M	GORDON-SCOTT ANTON	Cadet Kumite Male -57 kg	
	ENG003614	M	JOHNSON-CAMPBELL AARON	Junior Kumite Male -68 kg	
	ENG03247	M	LANGHORN THEO	Junior Kata Male	4
	ENG003607	M	LOKAJ DRIN	Junior Kumite Male 76+ kg	
	ENG003609	M	MORGAN HARRY	Cadet Kumite Male -52 kg	
	ENG02926	M	PATRICK ASHTON	U21 Kumite Male -84 kg	1
	ENG003390	M	ROWE BRANDON	U21 Kata Male	
	ENG003602	M	SAI WUN LI JAKE	Cadet Kata Male	
	ENG003600	M	WATTS CONNOR	Junior Kumite Male -61 kg	
	ENG02903	M	YOGARAJAH KOBE	U21 Kumite Male -60 kg	
	ENG003392	F	BERRY LAUREN	Cadet Kumite Female -61 kg	
	ENG02890	F	BLAKE TAHLIA	U21 Kumite Female -61 kg	
	ENG003393	F	CARRUTHERS ARABELLA	U21 Kumite Female -55 kg	
	ENG003603	F	CARTWRIGHT CONI MAE	U21 Kata Female	
	ENG003389	F	CHANGER ANNABEL	Junior Kumite Female -48 kg	
	ENG003394	F	CUTLER SOFIA	Junior Kumite Female -66 kg	
	ENG02912	F	FRY AUTUMN	U21 Kumite Female 68+ kg	
	ENG003599	F	HANDLEY SKYLA	Cadet Kumite Female 61+ kg	
	ENG003610	F	MORAN EMILY	Junior Kumite Female -53 kg	
	ENG03254	F	NARDELLI TALIA	Junior Kumite Female -59 kg	4
	ENG02902	F	TEWLEY RENEE	Junior Kumite Female 66+ kg	
	ENG003605	F	URBAN MAJA	Cadet Kumite Female -54 kg	
	ENG03253	F	WEGRZYN NADA	Junior Kata Female	
	ENG02901	F	WYMAN JESSE	U21 Kumite Female -68 kg	
EST	EST002740	M	BOKOV ROLAN	U21 Kumite Male -75 kg	
	EST02462	M	BOLOTSKIIHH SAVELI	U21 Kumite Male -84 kg	
	EST02637	M	FOMIN KIRILL	Junior Kumite Male 76+ kg	
	EST002778	M	HALJAS ADRIAN	Cadet Kumite Male -57 kg	
	EST02601	M	ILJENKO ILJA	Junior Kumite Male -68 kg	
	EST02600	M	TIMAK TAAGO	Junior Kumite Male -55 kg	
	EST002775	F	AIGRO MARI	Junior Kumite Female -53 kg	
	EST02567	F	ANNION LISETTE	U21 Kumite Female -55 kg	
	EST002738	F	ANTONOVA ANNIKA	Junior Kata Female	



EKF Junior, Cadet & U21 Championships 2026 - Lim..



ENTRIES BY NATIONAL FEDERATION

As of 8 FEB 2026

Code	ID	Gender	Name	Event	Seeding
EST	EST002777	F	FOMKINA ARINA	Cadet Kumite Female 61+ kg	
	EST02566	F	LANBERG ALJONA	Junior Kumite Female 66+ kg	
	EST02460	F	LETT ANNALIISA	U21 Kumite Female -68 kg	
	EST002776	F	TEHVAND KADRI JOHANNA	Junior Kumite Female -59 kg	
FIN	FIN002862	M	KREUS PETRUS	Junior Kumite Male -76 kg	
	FIN02182	M	MANTERE JIMI	U21 Kumite Male 84+ kg	
	FIN002718	M	SIMONEN RENE	Junior Kumite Male -68 kg	
	FIN002714	M	TAKALA AKSELI	U21 Kata Male	
	FIN002828	M	TAKALA ANTON	Cadet Kumite Male -70 kg	
	FIN002861	F	HANNU ALVA	Junior Kumite Female -48 kg	
	FIN002719	F	ITKONEN JANIKA	Junior Kumite Female -53 kg	
	FIN02259	F	SAADAQUI SONYA	U21 Kumite Female -68 kg	
	FIN002827	F	STEFANSKI VANESSA	Cadet Kumite Female -61 kg	
	FIN002824	F	WANIC MARIE	Cadet Kata Female	
FRA	FRA004446	M	AKGUN MUHAMMED ALI	Junior Kumite Male 76+ kg	
	FRA004196	M	AMMOUR ZIYANE	Cadet Kumite Male 70+ kg	
	FRA004510	M	BA DEMBA	Cadet Kumite Male -52 kg	
	FRA004200	M	BETTACHE YASIN	U21 Kumite Male -67 kg	
	FRA03068	M	CISSOKHO ISMAILA	U21 Kumite Male -75 kg	
	FRA04093	M	COURTOIS TOM	U21 Kata Team Male	
	FRA004318	M	DEBERDT MAHE	Cadet Kumite Male -57 kg	4
	FRA04087	M	DOULI MATHIS	Junior Kumite Male -76 kg	
	FRA02801	M	ERNWEIN THOMAS	U21 Kumite Male -60 kg	
	FRA004206	M	FRANCES ADRIEN	Kata Team Cadet and Junior Male	
	FRA004506	M	HAMMADA ANASS	Junior Kumite Male -55 kg	
	FRA02808	M	HOFFMANN LUCAS	U21 Kata Team Male	
	FRA02808	M	HOFFMANN LUCAS	U21 Kata Male	2
	FRA004316	M	HUYET-DUMONG THOMAS	Kata Team Cadet and Junior Male	
	FRA004502	M	KANGA KERTISS	U21 Kumite Male -84 kg	
	FRA04085	M	KLEMZ THOMAS	Junior Kata Male	2
	FRA03844	M	LAMBERT LEO	Junior Kumite Male -61 kg	
	FRA03296	M	PELTIER TOM	U21 Kata Team Male	
	FRA004317	M	PILLANT METIS	Cadet Kata Male	
	FRA004317	M	PILLANT METIS	Kata Team Cadet and Junior Male	
	FRA03847	M	RAMDANI MOHAMMED HAROUN	Kata Team Cadet and Junior Male	
	FRA03554	M	TADJER ADAM	U21 Kumite Male 84+ kg	
	FRA03845	M	TAKLIT ANIS	Junior Kumite Male -68 kg	
	FRA004501	M	TARZOUT ADIL YUCEF	Cadet Kumite Male -70 kg	
	FRA004509	M	THOZE EMEN MATTHEW	Cadet Kumite Male -63 kg	
	FRA03633	F	ABDESSELEM SYLIA	U21 Kumite Female -55 kg	
	FRA03459	F	ARZUMIAN MONICA	U21 Kumite Female -61 kg	
	FRA02791	F	BUI MAI LINH	U21 Kata Female	3
	FRA004508	F	CAMINADE MARIANNE	Cadet Kumite Female -47 kg	
	FRA004205	F	CAPET LOUISE	Kata Team Cadet and Junior Female	1
FRA004504	F	CAYLA ANAIS	Cadet Kata Female		
FRA03436	F	COCHARD LOLA	U21 Kumite Female -50 kg		
FRA004498	F	DELORME AMINA	Cadet Kumite Female -54 kg		



EKF Junior, Cadet & U21 Championships 2026 - Lim..



ENTRIES BY NATIONAL FEDERATION

As of 8 FEB 2026

Code	ID	Gender	Name	Event	Seeding
FRA	FRA004306	F	ESSABAR MERYEM	Cadet Kumite Female 61+ kg	
	FRA004507	F	KAKICHE MANOUA	Cadet Kumite Female -61 kg	
	FRA04091	F	KOUME LEE-LOU	Junior Kumite Female -48 kg	1
	FRA004505	F	ONANA CHARLENE	Junior Kumite Female 66+ kg	
	FRA03455	F	OZSERTTAS ZERA JADE	U21 Kumite Female 68+ kg	
	FRA04089	F	PICAZO LUQUE ELEONOR	Junior Kumite Female -66 kg	
	FRA03306	F	PORQUET FAITH	U21 Kumite Female -68 kg	4
	FRA004452	F	RUIZ ORIANE	Junior Kumite Female -53 kg	
	FRA004201	F	SCARFONE MORGANE	Junior Kumite Female -59 kg	
	FRA03840	F	VAUCELLE-SPELLE NINON	Kata Team Cadet and Junior Female	1
	FRA03840	F	VAUCELLE-SPELLE NINON	Junior Kata Female	
	FRA04094	F	VILANOVA JULIA	Kata Team Cadet and Junior Female	1
	FRA004503	F	VORATOVIC ILIANA	Kata Team Cadet and Junior Female	1
GEO	GEO02857	M	ABULADZE NIKOLOZ	Junior Kumite Male -68 kg	
	GEO02860	M	ALANIA GIGI	Junior Kumite Male -55 kg	
	GEO002914	M	ARUTINOV ARTIOM	Junior Kumite Male -76 kg	
	GEO02813	M	DADESHKELIANI LEVANI	Cadet Kumite Male -52 kg	1
	GEO003075	M	DEMURIA DIEGO	Cadet Kumite Male -70 kg	
	GEO02558	M	DONADZE ANZOR	U21 Kumite Male -75 kg	
	GEO02556	M	GIGAURI NIKOLOZ	U21 Kumite Male 84+ kg	
	GEO003076	M	GOGRICHIANI OMAR	Cadet Kumite Male 70+ kg	
	GEO002911	M	KHATISASHVILI DAVIT	Junior Kumite Male -61 kg	
	GEO02810	M	KONJARIA NIKO	Junior Kumite Male 76+ kg	
	GEO02670	M	KUZANASHVILI LUKA	U21 Kumite Male -67 kg	
	GEO02811	M	SUPATASHVILI NODARI	U21 Kumite Male -60 kg	
		M	TSULAIA NIKOLOZI	Cadet Kumite Male -57 kg	
	GEO003029	F	AMBARYAN LIKA	Cadet Kumite Female 61+ kg	
	GEO002913	F	KAKUTIA SALOME	Cadet Kumite Female -47 kg	3
		F	KHUROSHVILI BARBARE	Cadet Kumite Female -61 kg	
	GEO02871	F	KHURTSILAVA LIA	U21 Kata Female	
	GEO02865	F	KULUKHASHVILI MAKI	Junior Kumite Female -66 kg	
	GEO003028	F	LOMTADZE DARINA	Junior Kumite Female -59 kg	
	GEO003073	F	OTINASHVILI ELENE	Junior Kumite Female 66+ kg	
	GEO002922	F	PIRTSKHALAVA LIKA	U21 Kumite Female -68 kg	
	GEO02669	F	VASADZE MARIAMI	U21 Kumite Female -50 kg	
GER	GER004274	M	ATHANASSIAS APOSTOLOS	Kata Team Cadet and Junior Male	
	GER03274	M	BECKER SEBASTIAN	U21 Kata Team Male	
	GER004277	M	FICHTELMANN ERIC	Cadet Kumite Male -52 kg	
	GER004276	M	GRAEFE LUKAS	Cadet Kumite Male -70 kg	
	GER004265	M	GSCHWIND VICTOR	Kata Team Cadet and Junior Male	
	GER02914	M	HADIZADEH JULIAN	U21 Kata Team Male	
	GER02948	M	JENDREIZIK OLE	U21 Kumite Male -84 kg	
	GER004275	M	JORDE-NAKAMATSU LIO	Junior Kata Male	
	GER03797	M	KUNIYASU HARUAKI	Kata Team Cadet and Junior Male	
	GER004127	M	KURZ PHIL	Junior Kumite Male 76+ kg	
	GER004073	M	LIBIK DANIEL	Cadet Kata Male	
	GER004279	M	LIUBYMOV DMYTRO	Junior Kumite Male -55 kg	



EKF Junior, Cadet & U21 Championships 2026 - Lim..



ENTRIES BY NATIONAL FEDERATION

As of 8 FEB 2026

Code	ID	Gender	Name	Event	Seeding
GER	GER03128	M	LUECK ANDREW LYLE	U21 Kata Team Male	
	GER03128	M	LUECK ANDREW LYLE	U21 Kata Male	
	GER004224	M	MARTIN MAXIMILIAN	Cadet Kumite Male -63 kg	
	GER004278	M	MORINA ARTION	Cadet Kumite Male -57 kg	
	GER003924	M	MUELLER MARIUS	Junior Kumite Male -76 kg	
	GER003980	M	NAMYSLIK FELIX	Junior Kumite Male -61 kg	
	GER03306	M	NIEDERELZ TIM	Junior Kumite Male -68 kg	
	GER03121	M	OBITZ FLORIAN	U21 Kumite Male -60 kg	
	GER003925	M	RAISWICH ROMAN	U21 Kumite Male -75 kg	
	GER03357	M	SAFI HEIDAR	U21 Kumite Male -67 kg	
	GER004229	M	SEJFIC SEFO	U21 Kumite Male 84+ kg	
	GER003877	F	BAGHDJIAN DANA	Kata Team Cadet and Junior Female	
	GER03808	F	DAWOUD DALIA	Junior Kumite Female 66+ kg	4
	GER03796	F	DREWES LEYLA	Junior Kumite Female -48 kg	
	GER03868	F	EWALD CLARA	U21 Kata Team Female	
	GER03137	F	FRATILA CRISTINA-MARIA	U21 Kumite Female -68 kg	
	GER004012	F	GOETHE MARIEL	Kata Team Cadet and Junior Female	
	GER004012	F	GOETHE MARIEL	Cadet Kata Female	1
	GER003876	F	GOTTSCHALK EMMA	Junior Kumite Female -53 kg	
	GER03304	F	HELLEN ILI	Junior Kumite Female -59 kg	
	GER03126	F	JAY SHIRLEY	U21 Kata Female	
	GER03282	F	JUERGENSMANN ANNIKA	U21 Kata Team Female	
	GER03639	F	KOENIG LIV SVENDE	Junior Kumite Female -66 kg	
	GER004069	F	KONRADI ARWEN	Cadet Kumite Female 61+ kg	
	GER004072	F	LIBIK TAMARA	Junior Kata Female	
	GER004223	F	MEYEN SELDA	Cadet Kumite Female -61 kg	3
	GER02725	F	OTT SIDNEY-MICHELLE	U21 Kumite Female -55 kg	
	GER003879	F	PODVOREC NIVES	Cadet Kumite Female -47 kg	1
	GER004222	F	ROEDER LUISE	Cadet Kumite Female -54 kg	
	GER03138	F	RUEHLMANN CHARLOTTE	U21 Kumite Female 68+ kg	
	GER004216	F	SCHAUDIG LUISA	Kata Team Cadet and Junior Female	
	GER03258	F	SEMENENKO ANASTASIIA	U21 Kumite Female -61 kg	1
	GER03124	F	STEVENS JULIE	U21 Kata Team Female	
	SD48610	F	WOLF ALEXANDRA	U21 Kumite Female -50 kg	
GRE	GRE02915	M	ARGYRAKIS CHRISTOS	Junior Kumite Male 76+ kg	
	GRE02321	M	BALIoTIS GEORGIOS	U21 Kumite Male -67 kg	2
	GRE03105	M	GIANNAKIS MARIOS	U21 Kumite Male -75 kg	
	GRE03033	M	KOUMPENAKIS VASILEIOS	Junior Kumite Male -61 kg	3
	GRE004266	M	LAZARIDIS PANAGIOTIS	Cadet Kumite Male 70+ kg	
	GRE03040	M	LEKAKOS PARIS	Cadet Kata Male	
	GRE03456	M	LENOS DIMITRIOS	Cadet Kumite Male -63 kg	
	GRE2164	M	MERKOURIS THEODOROS	U21 Kumite Male -60 kg	
	GRE02448	M	MOKAS MICHAIL	U21 Kumite Male 84+ kg	
	GRE02848	M	MORAITIS ANGELOS	Junior Kumite Male -68 kg	
	GRE03047	M	MORAITIS IOANNIS-ADAMANTIOS	Cadet Kumite Male -52 kg	
	GRE02758	M	PAPADOPOULOS DIMOSTHENIS	Junior Kumite Male -55 kg	
	GRE02762	M	PAPAGRIGORIOU KOSMAS	Junior Kumite Male -76 kg	



EKF Junior, Cadet & U21 Championships 2026 - Lim..



ENTRIES BY NATIONAL FEDERATION

As of 8 FEB 2026

Code	ID	Gender	Name	Event	Seeding	
GRE	GRE03703	M	PAPPAS CHARILAOS	Junior Kata Male		
	GRE02300	M	PSOMAS ILIAS	U21 Kumite Male -84 kg		
	GRE003744	M	PSOMAS IOANNIS	Cadet Kumite Male -70 kg		
	GRE004267	M	STAVRIDIS DIMITRIOS	Cadet Kumite Male -57 kg		
	GRE02494	M	TSIAKMAKIS FOTIOS	U21 Kata Male		
	GRE02753	F	ANASTASIADI ANASTASIA	Cadet Kumite Female -54 kg	4	
	GRE02755	F	ANASTASIADI MARINA	Cadet Kumite Female -61 kg		
	GRE02831	F	ANASTASIOU MARIA GEORGIA	U21 Kumite Female 68+ kg		
	GRE03415	F	BOUGIOUKLAKI SPYRIDOULA	Kata Team Cadet and Junior Female		
	GRE03415	F	BOUGIOUKLAKI SPYRIDOULA	Cadet Kata Female		
	GRE03631	F	DOUKA VIOLETTA-FANOURIA	Junior Kumite Female -66 kg		
	GRE03013	F	DOUKA EFFROSYNI DAVIDOULA	Junior Kumite Female 66+ kg		
	GRE02442	F	KATSIKA EIRINI-GRIGORIA	U21 Kumite Female -68 kg	2	
	GRE03419	F	KOMINI ILIANA	Junior Kumite Female -48 kg		
	GRE03039	F	LAMPADA DANAI	Kata Team Cadet and Junior Female		
	GRE02642	F	PAPPA CHRISTINA TRIADA	U21 Kumite Female -50 kg		
	GRE03062	F	PERGALIA ANASTASIA-EIRINI	Cadet Kumite Female 61+ kg	4	
	GRE004264	F	POLYKANDRIOTI MARINA	Cadet Kumite Female -47 kg		
		F	RESVANI VASILIKI	Junior Kumite Female -59 kg		
	GRE02495	F	TSIAKMAKI ATHINA	U21 Kata Female		
	GRE02320	F	XENOU LYDIA LAMPRINI	U21 Kumite Female -61 kg		
	GRE03223	F	ZAMANTZA MARIA-ANTONIA	U21 Kumite Female -55 kg		
	GRE03095	F	ZERVOU ELENI	Kata Team Cadet and Junior Female		
	GRE03095	F	ZERVOU ELENI	Junior Kata Female		
	GRE004268	F	ZEZAI MARINA	Junior Kumite Female -53 kg		
	HUN	HUN003520	M	BAGI ADAM	Cadet Kumite Male -63 kg	
		HUN003513	M	BALI TIBOR	Cadet Kumite Male 70+ kg	
HUN003515		M	FELSZNER ERIK	Junior Kumite Male -68 kg		
HUN003372		M	GOMBKOTO BALINT	Junior Kumite Male 76+ kg		
HUN03076		M	KIS MATYAS	Cadet Kumite Male -70 kg		
HUN03003		M	KOVACS GERGELY KRISTOF	Junior Kumite Male -61 kg		
HUN003516		M	LISAL DAVID	U21 Kumite Male -84 kg		
HUN003324		M	LOSONCI LORANT MARCELL	Junior Kumite Male -55 kg		
HUN003512		M	PASZTOR SZABOLCS	Cadet Kumite Male -52 kg		
HUN003371		M	RUZSINSZKI BALAZS	Junior Kumite Male -76 kg		
HUN02531		M	TOTH MATE	U21 Kumite Male -75 kg		
HUN02532		M	TOTH ZSOMBOR	U21 Kumite Male -67 kg		
HUN003514		F	ADAM ADRIENN	Junior Kumite Female -59 kg		
HUN003521		F	ADAM VIVIEN	Junior Kumite Female -66 kg		
HUN03074		F	BACSO KATA	Kata Team Cadet and Junior Female		
HUN03073		F	BENKO SZONJA LOLA	Kata Team Cadet and Junior Female		
HUN03073		F	BENKO SZONJA LOLA	Cadet Kata Female		
HUN02618		F	BOGDAN PANNA ZSOFIA	U21 Kumite Female -68 kg		
HUN02677		F	FLEISCHER DORA	U21 Kumite Female 68+ kg	1	
HUN02768		F	FODOR AMIRA	U21 Kata Team Female		
HUN003329		F	HEFNER ZSOFIA AGNES	Junior Kumite Female -48 kg		
HUN02761		F	HOGENBURG LUCA	U21 Kata Team Female		



EKF Junior, Cadet & U21 Championships 2026 - Lim..



ENTRIES BY NATIONAL FEDERATION

As of 8 FEB 2026

Code	ID	Gender	Name	Event	Seeding
HUN	HUN02761	F	HOGENBURG LUCA	U21 Kata Female	
	HUN003519	F	HUSZTY ZSUZSANNA	Kata Team Cadet and Junior Female	
	HUN02775	F	KISS KITTI	U21 Kata Team Female	
	HUN003330	F	KUN REGINA KIRA	Cadet Kumite Female -54 kg	
	HUN003511	F	MAYERHOFFER MERI	Cadet Kumite Female 61+ kg	
	HUN02787	F	MOLNAR VIRAG	U21 Kumite Female -55 kg	
	HUN003510	F	PETER PANNA	Cadet Kumite Female -47 kg	
	HUN003517	F	SZEBEGYINSZKI RITA	Junior Kumite Female 66+ kg	
	HUN003518	F	TAMASI ZSOFIA BOGLARKA	U21 Kumite Female -61 kg	
	HUN02867	F	TOROK PANKA	Junior Kumite Female -53 kg	
ISL	ISL002527	M	AGNESAR GUNNARSSON OSKAR INGI	Junior Kumite Male -76 kg	
	ISL002492	M	BUENVIAJE CAAMIC PRINCE JAMES	Junior Kata Male	
	ISL002492	M	BUENVIAJE CAAMIC PRINCE JAMES	Junior Kumite Male -55 kg	
	ISL2109	M	HALLDORSSON HUGI	U21 Kumite Male -84 kg	
	ISL002526	M	JONSSON ARON BUILAM	Junior Kumite Male -68 kg	
	ISL02320	F	HALLDORSDDOTTIR EMBLA	Junior Kumite Female -59 kg	
IRL	IRL02799	M	AINSCOUGH LEE	U21 Kumite Male -75 kg	
	IRL003210	M	CERKASINS TIMUR	Cadet Kumite Male -63 kg	
	IRL003103	M	GORA MARCEL	Cadet Kumite Male 70+ kg	
	IRL03044	M	HENEGHAN ALEX	Junior Kumite Male -68 kg	
	IRL02798	M	KELLY CATHAL	U21 Kumite Male -67 kg	
	IRL02840	M	KELLY TOMAS	U21 Kumite Male -60 kg	
	IRL02946	M	MC CANN CALVIN	Cadet Kata Male	1
	IRL003055	M	MCGLYNN MICHAEL	Cadet Kumite Male -70 kg	
	IRL003175	M	OBRIEN JACE	Cadet Kumite Male -57 kg	
	IRL02843	M	PHELAN SEAN	Junior Kumite Male -61 kg	
	IRL003097	M	SCANNELL JACK	U21 Kata Male	
	IRL02945	M	WONG-LYE CHRISTOPHER CHUNG YIN	Junior Kumite Male -76 kg	
	IRL02945	M	WONG-LYE CHRISTOPHER CHUNG YIN	Junior Kata Male	
	IRL003212	F	BYRNE ELLA	Junior Kumite Female -53 kg	
	IRL02797	F	CLARE AVA	U21 Kumite Female 68+ kg	
	IRL003100	F	HARNEY ANNA	U21 Kata Female	
	IRL003211	F	KELLY REBECCA	Cadet Kumite Female 61+ kg	
	IRL003209	F	MCDERMOTT MICHAELA	Cadet Kumite Female -61 kg	
	IRL02910	F	MULHERN LUCY	U21 Kumite Female -50 kg	
	IRL003107	F	OLDREY ELLEN	Cadet Kumite Female -54 kg	
IRL02943	F	REEN ASHA	Junior Kumite Female -59 kg		
IRL003102	F	SHERIDAN SOPHIE	Junior Kumite Female -66 kg		
ISR	ISR02934	M	ABRAMCHAYEV NETANEL	Junior Kumite Male -55 kg	
	ISR02941	M	BAR MASHIAH SHAKED	U21 Kumite Male -67 kg	
	ISR02935	M	DE LEVIE YANNAI	Kata Team Cadet and Junior Male	
	ISR02942	M	FILSHCHYNSKYI MARK	U21 Kumite Male -60 kg	
	ISR003241	M	GUTIERREZ ARIEL	Junior Kumite Male 76+ kg	
	ISR003245	M	KASABRY NASRY	U21 Kumite Male -84 kg	



EKF Junior, Cadet & U21 Championships 2026 - Lim..



ENTRIES BY NATIONAL FEDERATION

As of 8 FEB 2026

Code	ID	Gender	Name	Event	Seeding
ISR	ISR02937	M	KAUFMAN NETA	Kata Team Cadet and Junior Male	
	ISR02931	M	KIRNOSOV ANDREY	Cadet Kumite Male -63 kg	
	ISR02987	M	KUZMIN NIKITA	Junior Kumite Male -61 kg	
	ISR02944	M	LOEBEL YALI IDAN	Cadet Kata Male	
	ISR02468	M	MANSOR CARMEL	U21 Kata Male	
	ISR003246	M	RABAN NIV	Kata Team Cadet and Junior Male	
	ISR003205	M	SABA MICHAEL	Cadet Kumite Male -70 kg	
	ISR02933	M	SAMADOV ILGAR	Cadet Kumite Male -52 kg	
	ISR02932	M	VERCHILOVSKY LIAM	Cadet Kumite Male -57 kg	
	ISR003101	M	VOLFSON TAL	Cadet Kumite Male 70+ kg	4
	ISR003135	M	YAKHEDS ADAM	Junior Kumite Male -68 kg	
	ISR003102	M	YAKHEDS YAN	Junior Kumite Male -76 kg	
	ISR003242	F	BULATNIKOV NADIN	Cadet Kumite Female -61 kg	
	ISR003099	F	COHEN ELLA	Junior Kumite Female -48 kg	
	ISR02860	F	IASKOV TATIANA	Junior Kumite Female -53 kg	
	ISR003240	F	KIMYAGAROV LIEL	Cadet Kumite Female -47 kg	
	ISR003244	F	KRIKUN HADAR	Junior Kumite Female -59 kg	
	ISR003243	F	RASIUK MATAR	Cadet Kumite Female -54 kg	
	ISR02583	F	ROKAH MIA	U21 Kata Female	
	ITA	ITA005573	M	APICELLA CARMINE	Junior Kumite Male -61 kg
ITA005691		M	BALDASSARRE RAFFAELE	Cadet Kumite Male -63 kg	1
ITA04409		M	BURROSI SAMUELE	U21 Kumite Male 84+ kg	
ITA005925		M	CAFISO EDOARDO	Cadet Kumite Male -52 kg	
ITA05399		M	CARRARESI ALESSANDRO	Junior Kumite Male -76 kg	
ITA005916		M	DE GREGORIO RICCARDO	Cadet Kumite Male -70 kg	4
ITA005914		M	DEL SEPPIA GIACOMO	Cadet Kumite Male 70+ kg	2
ITA04766		M	DI RUBBA LUIGI	U21 Kata Team Male	
ITA005601		M	FERRARINI FRANCESCO	Junior Kumite Male 76+ kg	1
ITA05407		M	FREDA MATTEO	Kata Team Cadet and Junior Male	1
ITA04234		M	GIORDANO FABRIZIO	U21 Kumite Male -67 kg	
ITA005926		M	GIULIANI ACHILLE	Cadet Kumite Male -57 kg	
ITA03876		M	IANNUZZI MARIO	U21 Kumite Male -75 kg	2
ITA005923		M	MARCHESE LUCIO	Junior Kata Male	
ITA04187		M	MATACCHIONI LUIGI	U21 Kata Team Male	
ITA005910		M	MONDO BRANCHI MATTEO	Junior Kumite Male -55 kg	
ITA005917		M	NARDACCIO MATTEO	Kata Team Cadet and Junior Male	1
ITA005917		M	NARDACCIO MATTEO	Cadet Kata Male	
ITA03831		M	PAPPALARDO VINCENZO	U21 Kata Team Male	
ITA03831		M	PAPPALARDO VINCENZO	U21 Kata Male	3
ITA02898		M	PEZZOTTI GABRIELE	U21 Kumite Male -84 kg	2
ITA005919		M	PUTELLI NICOLO	Kata Team Cadet and Junior Male	1
ITA005918		M	ROSIELLO MARCO	Kata Team Cadet and Junior Male	1
ITA04226		M	SERGI FRANCESCO	U21 Kata Team Male	
ITA04271		M	SQUILLANTE GUIDO	U21 Kumite Male -60 kg	
ITA05400		M	TOMMASINO ALMERICO	Junior Kumite Male -68 kg	2
ITA005922		F	BERETTA MARTINA	Cadet Kata Female	3
ITA05402		F	CAPATTI GIADA	Junior Kumite Female -48 kg	



EKF Junior, Cadet & U21 Championships 2026 - Lim..



ENTRIES BY NATIONAL FEDERATION

As of 8 FEB 2026

Code	ID	Gender	Name	Event	Seeding
ITA	ITA05403	F	CAPONE BIANCA	Junior Kumite Female -53 kg	4
	ITA05404	F	CATTANEO ELISA	Junior Kumite Female -66 kg	1
	ITA005580	F	COCCA MARIALUIGIA	Junior Kumite Female -59 kg	
	ITA05405	F	CORREDDU NICOLE	Junior Kumite Female 66+ kg	1
	ITA2181	F	CRUCITTI FRANCESCA	U21 Kata Team Female	
	ITA005582	F	CRUCITTI SOFIA	Junior Kata Female	
	ITA03632	F	DE GREGORIO GABRIELLA	U21 Kata Team Female	
	ITA04269	F	DESIDERIO ANNA PIA	U21 Kumite Female -68 kg	1
	ITA04188	F	DOMINICI ROBERTA	U21 Kata Team Female	
	ITA04188	F	DOMINICI ROBERTA	U21 Kata Female	
	ITA005920	F	DUBLINO BEATRICE	Kata Team Cadet and Junior Female	4
	ITA005927	F	ESPOSITO EMILIA	Kata Team Cadet and Junior Female	4
	ITA005909	F	GENOCCHIO ISABEL	Cadet Kumite Female -61 kg	
	ITA04268	F	LEGITTIMO LUDOVICA	U21 Kumite Female -50 kg	2
	ITA005911	F	MARENCO MAYA	Cadet Kumite Female -54 kg	
	ITA03806	F	MARTURANO IRENE	U21 Kumite Female -61 kg	
	ITA005913	F	ONORI SOFIA	Cadet Kumite Female 61+ kg	
	ITA05406	F	ORSETTI ANNA	Kata Team Cadet and Junior Female	4
	ITA04767	F	ORTU REBECCA	U21 Kumite Female -55 kg	
	ITA04248	F	PADOAN MARTINA	U21 Kata Team Female	
	ITA03079	F	PERGOLES ASIJA	U21 Kumite Female 68+ kg	2
	ITA005912	F	SERVETTO THEA	Cadet Kumite Female -47 kg	
	ITA005694	F	TAGLIABUE SILVIA	Kata Team Cadet and Junior Female	4
LAT	LAT02515	M	BALZARIS MIROSLAVS	Junior Kumite Male -55 kg	
	LAT003118	M	DRILLIS EMILS	Junior Kata Male	
	LAT003160	M	GREBNOVS ILJA	Cadet Kumite Male -52 kg	
	LAT02715	M	JAUDZEMS GUSTAVS	Cadet Kata Male	
	LAT2213	M	KALVANS DENISS	U21 Kumite Male -75 kg	
	LAT003164	M	NIPANS ROBERTS	Junior Kumite Male 76+ kg	
	LAT003015	M	OZEROVS ARTJOMS	Cadet Kumite Male -63 kg	
	LAT02550	M	PUKE ROBERTS	U21 Kumite Male -84 kg	
	LAT003159	M	PUMPURS ANDREJS	Cadet Kumite Male -57 kg	
	LAT003155	M	SKALITIS KRISTAPS	Junior Kumite Male -76 kg	
	LAT002964	M	SOROHOVS KIRILLS	Junior Kumite Male -68 kg	
	LAT003162	M	VIETRINS MAKSIMS	Junior Kumite Male -61 kg	
	LAT003161	F	AKOPOVA KATRINA	Cadet Kumite Female -54 kg	
	LAT003163	F	AVRUSKINA JELIZAVETA	Cadet Kumite Female 61+ kg	
	LAT02561	F	GIRVICA BEATA	U21 Kumite Female -61 kg	
	LAT002972	F	IVANOVA AURELIJA	Cadet Kata Female	
	LAT003011	F	JERMAONOKA NATALIJA	Junior Kumite Female -59 kg	
	LAT02714	F	KONAJEVA JEVGENIJA	Junior Kumite Female -48 kg	
	LAT003154	F	NIKONOVA ARINA	Cadet Kumite Female -47 kg	
	LAT02518	F	PUISANE LAUMA	Junior Kumite Female -53 kg	
LAT002971	F	SELAVKO OLGA	Cadet Kumite Female -61 kg		
LAT02719	F	SPRADZINA ARIANNA	Junior Kumite Female -66 kg		
LTU	LTU002629	M	GASICKAS ROKAS	Junior Kata Male	
	LTU002589	M	KAZIUKAITIS PRANAS	Cadet Kumite Male -63 kg	



EKF Junior, Cadet & U21 Championships 2026 - Lim..



ENTRIES BY NATIONAL FEDERATION

As of 8 FEB 2026

Code	ID	Gender	Name	Event	Seeding
LTU	LTU002738	M	LOGVINENKO KIRIL	Cadet Kumite Male 70+ kg	
	LTU002737	M	LUKOSEVICIUS MATIAS	Cadet Kata Male	
	LTU002701	M	NOLIUS VINGAUDAS	Junior Kumite Male -68 kg	
	LTU002702	M	SOKAS TADAS	Cadet Kumite Male -52 kg	
	LTU02522	M	VARANKINAS KAJUS	Junior Kumite Male -61 kg	
	LTU002632	M	ZAUKAS KAROLIS	U21 Kumite Male 84+ kg	
	LTU002733	F	BRUNIUTE ERIKA	Cadet Kata Female	
	LTU002739	F	BUTKUTE ANDREJA	Junior Kumite Female -59 kg	
	LTU002736	F	BUTKUTE AUSTEJA	Cadet Kumite Female 61+ kg	
	LTU02348	F	DRIUCIKAITE ROBERTA	U21 Kumite Female -50 kg	
	LTU02310	F	LIUTKEVICIUTE MIGLE	U21 Kumite Female -55 kg	
	LTU002735	F	STAVECKAITE BARBORA	Cadet Kumite Female -61 kg	
	LTU02421	F	VARANKINAITE KAMILE	U21 Kumite Female -68 kg	
	LTU002587	F	VOLODZKAITE GERDA	Junior Kumite Female -66 kg	
LTU002734	F	ZAJANCKAUSKYTE KOTRYNA	Cadet Kumite Female -47 kg		
LUX	LUX02468	M	AGOSTINO ENZO	Junior Kumite Male -61 kg	
	LUX02425	M	ARCQ ALEXANDER	Junior Kata Male	
	LUX02431	M	CHAFFORT LUCAS	U21 Kata Male	
	LUX02279	M	DAVIES ALEXANDER	U21 Kumite Male 84+ kg	
	LUX02316	M	PIERANTONI MATTEO	Junior Kumite Male -76 kg	
	LUX02193	M	SIBILLE JORDAN	U21 Kumite Male -67 kg	3
	LUX02667	M	SZEKERES MAXIM	Junior Kumite Male -55 kg	
	LUX02427	M	TODOROVIC FILIP	Junior Kumite Male -68 kg	
	LUX02650	F	BELABASS ZINEB	Cadet Kumite Female -47 kg	
	LUX02321	F	BREISCH ANNA	Junior Kata Female	
	LUX02677	F	BRESER ANASTASIA	Cadet Kata Female	
	LUX02651	F	COQUILLARD ELISE	Junior Kumite Female -53 kg	
	LUX02432	F	DE RUBEIS GIULIA	Junior Kumite Female -66 kg	
	LUX02680	F	DURRER NAHIMA	Cadet Kumite Female -61 kg	
	LUX02474	F	GAWELLEK SARAH	Junior Kumite Female -59 kg	
	LUX02657	F	INTINI RAFFAELLI LARA	Cadet Kumite Female -54 kg	
	LUX02426	F	JADIN LANA	U21 Kumite Female -55 kg	
	LUX02191	F	MOENS ALIX	U21 Kumite Female -50 kg	
	LUX2154	F	REDING MIA	U21 Kata Female	
LUX02658	F	TERLICA GOMES OCEANE	Junior Kumite Female -48 kg		
MLT	MLT02320	M	ATTARD JEREMY	U21 Kumite Male -60 kg	
	MLT002362	M	GRECH JADEN	Cadet Kumite Male -70 kg	
	MLT02203	M	PSAILA KAYDEN	Junior Kumite Male -68 kg	
	MLT02205	M	SANT ZACK	Junior Kumite Male -61 kg	
	MLT02160	F	ANTONELLI THYIS	Junior Kumite Female -66 kg	
	MLT02238	F	AWAD ATTIA JENNA	Kata Team Cadet and Junior Female	
	MLT02238	F	AWAD ATTIA JENNA	Cadet Kata Female	2
	MLT02329	F	MADDEN LEIA-SUMMER	Cadet Kumite Female -54 kg	
	MLT02199	F	MIZZI EMMA	U21 Kumite Female -55 kg	
	MLT02241	F	ROADLEY-BATTIN EVIE	Kata Team Cadet and Junior Female	
	MLT02201	F	SALIBA FRANCESCA	Junior Kata Female	
MLT02201	F	SALIBA FRANCESCA	Kata Team Cadet and Junior Female		



EKF Junior, Cadet & U21 Championships 2026 - Lim..



ENTRIES BY NATIONAL FEDERATION

As of 8 FEB 2026

Code	ID	Gender	Name	Event	Seeding
MLT	MLT2116	F	VELLA JESSICA	U21 Kata Female	
MDA	MDA02267	M	CAPMOALE ALEXANDR	U21 Kumite Male -67 kg	
	MDA02453	M	CUCUL SAVELII	Junior Kumite Male 76+ kg	
	MDA02232	M	DOBROVOLSCHI DENIS	Junior Kumite Male -68 kg	
	MDA02375	M	GUZUN DAN	U21 Kumite Male -75 kg	
	MDA02304	M	STAVARACHI RENAT	Cadet Kumite Male -52 kg	
	MDA02414	M	STOIANOV CHIRILL	Junior Kumite Male -61 kg	
	MDA02382	M	VOLEANSCHI AKIM	Cadet Kumite Male -63 kg	
	MDA02379	M	VOLEANSCHI ARSENI	Cadet Kumite Male -57 kg	
	MDA02341	F	RADAUTA LOREDANA	Cadet Kumite Female -54 kg	
	MDA002527	F	ROIBA MADALINA	Cadet Kumite Female -47 kg	
	MDA02413	F	SERBUL ALEXANDRINA	Junior Kata Female	
MNE	MNE02871	M	ALJOSEVIC ARIJAN	Cadet Kumite Male -52 kg	
	MNE03125	M	ALJOSEVIC BENJAMIN	Junior Kata Male	
	MNE03125	M	ALJOSEVIC BENJAMIN	Kata Team Cadet and Junior Male	3
	MNE2429	M	ARIFAJ ANES	Junior Kumite Male -76 kg	1
	MNE02869	M	BARJAKTAROVIC ALEKSA	Kata Team Cadet and Junior Male	3
	MNE2473	M	DANILOVIC BALS	Junior Kumite Male -61 kg	
	MNE2272	M	DJURCEVIC LAZAR	U21 Kumite Male -67 kg	
	MNE02994	M	DJURIC LUKA	Cadet Kumite Male -63 kg	
	MNE03307	M	DJUROVIC ALEKSA	Kata Team Cadet and Junior Male	3
	MNE02924	M	DURUTOVIC DJORDJE	U21 Kumite Male -84 kg	
	MNE03073	M	KOSOVIC ANDRIJA	Cadet Kumite Male 70+ kg	
	MNE2428	M	LAZOVIC BRANKO	Junior Kumite Male -55 kg	4
	MNE2186	M	POTPARA LAZAR	U21 Kumite Male 84+ kg	2
	MNE02873	M	RAKOCEVIC LAZAR	Cadet Kumite Male -70 kg	
	MNE2469	M	SALJIU JUSUF	Junior Kumite Male -68 kg	
	MNE02854	M	STEVOVIC UROS	Cadet Kata Male	
	MNE2277	M	VOJINOVIC BALS	U21 Kumite Male -60 kg	4
	MNE2430	M	VUCINIC VUK	Junior Kumite Male 76+ kg	
	MNE2265	M	ZEJAK NIKSA	U21 Kumite Male -75 kg	
	MNE2293	F	BACKOVIC HELENA	U21 Kumite Female -55 kg	3
	MNE02598	F	BELJKAS NEDA	Cadet Kata Female	
	MNE03041	F	BLECIC DEJANA	Cadet Kumite Female -61 kg	
	MNE2289	F	BORICIC NADJA	U21 Kumite Female -61 kg	
	MNE2290	F	DAMJANOVIC JOVANA	U21 Kumite Female 68+ kg	
	MNE003990	F	DEDAJ MATEA	Cadet Kumite Female -47 kg	
	MNE03115	F	DJOROJEVIC GORANA	Cadet Kumite Female 61+ kg	
	MNE02633	F	DJUKIC KATARINA	Junior Kumite Female -59 kg	3
	MNE02877	F	MARKOVIC PETRA	Cadet Kumite Female -54 kg	
	MNE2253	F	MILIC JOVANA	U21 Kata Female	
	MNE03196	F	PERKOVIC TARA	Junior Kumite Female -48 kg	
	MNE2447	F	RAKOVIC UNA	Junior Kumite Female 66+ kg	
	MNE02886	F	SAKOTIC LARA	Junior Kumite Female -66 kg	
	MNE2426	F	VLAHOVIC KATARINA	Junior Kata Female	
	MNE03192	F	VUKCEVIC LANA	Junior Kumite Female -53 kg	
	MNE2257	F	ZAHRANE MARIAM	U21 Kumite Female -68 kg	



EKF Junior, Cadet & U21 Championships 2026 - Lim..



ENTRIES BY NATIONAL FEDERATION

As of 8 FEB 2026

Code	ID	Gender	Name	Event	Seeding
NED	NED02694	M	ACHGHOUYAB SAMY	U21 Kumite Male -67 kg	
	NED03276	M	BLUMINK LEVY	Junior Kumite Male -76 kg	
	NED003425	M	BOHOUDI ILYAS	Cadet Kumite Male -57 kg	1
	NED003574	M	BOHOUDI ISSAM	Cadet Kumite Male -70 kg	
	NED003577	M	BURGHOUT DAAN	U21 Kata Male	
	NED003575	M	DE ROVER LUKE	Junior Kumite Male 76+ kg	
	NED02684	M	FRANKEN RICARDO	U21 Kumite Male -75 kg	
	NED003352	M	KHARMICH ADAM	Cadet Kumite Male -63 kg	
	NED03275	M	LEPEZ DEVON	Junior Kumite Male -61 kg	4
	NED003578	M	NOERKHAN RAYAN	Junior Kata Male	
	NED02509	M	VAN DER WEIDE NIEK	U21 Kumite Male -84 kg	
	NED003576	M	ZARCHID MONCEF	Cadet Kumite Male 70+ kg	
	NED003350	F	LEPEZ DARLA	Cadet Kumite Female -47 kg	
	NED02733	F	VALK IMANE	Junior Kumite Female 66+ kg	
	NED003572	F	VAN KEULEN NORAH	Cadet Kumite Female -61 kg	
	NED02800	F	VOORDUIN ALYSSIA	U21 Kumite Female -55 kg	
	NED02464	F	YALCIN SAMINA	U21 Kumite Female -50 kg	
	NED02697	F	ZWANENBURG ROBIN	U21 Kumite Female -68 kg	
	MKD	MKD2418	M	BELISTOJANOSKI MATEJ	U21 Kumite Male -67 kg
MKD2296		M	BOZHVIKJ DANILO	U21 Kumite Male -84 kg	
MKD2476		M	DERVISHI NUREDIN	Junior Kata Male	
MKD2545		M	DIMOVSKI MARKO	U21 Kata Male	
MKD03023		M	DZORLEV MARKO	Cadet Kumite Male -63 kg	4
MKD03033		M	ELMAZI ISA	Cadet Kumite Male -70 kg	1
MKD03017		M	GJORGIEV MATTEO	Cadet Kata Male	
MKD03367		M	KURTANOVIC DARIN	Junior Kumite Male -68 kg	
MKD03320		M	MARGARITOV CVETAN	Junior Kumite Male -61 kg	
MKD003755		M	MEMEDI MERVAN	Cadet Kumite Male -52 kg	
MKD2290		M	MIHAJLOV LJUPCHE	U21 Kumite Male -75 kg	4
MKD02654		M	MITREVSKI DAMJAN	Junior Kumite Male -55 kg	
MKD03028		M	MLADENOVIC NEMANJA	Cadet Kumite Male 70+ kg	
MKD03323		M	NIKOLOVSKI DARIJAN	Junior Kumite Male 76+ kg	
MKD03024		M	PASHOV DJEM	Junior Kumite Male -76 kg	
MKD2587		M	STOJANOV FILIP	U21 Kumite Male 84+ kg	
MKD03007		M	STOJCHEVSKI ANDREJ	U21 Kumite Male -60 kg	
MKD03022		F	BRESLIEVA DUSICA	Junior Kumite Female -53 kg	
MKD02697		F	EVTIMOVSKA DRAGANA	Junior Kumite Female -59 kg	
MKD03256		F	FILIPOVSKA MIHAELA	Cadet Kumite Female -47 kg	
MKD03257		F	FRANGU HENA	Cadet Kumite Female -61 kg	
MKD003436		F	HIRA FIDANI	Cadet Kumite Female -54 kg	
MKD03326		F	ILIJOSKA JOVANA	Kata Team Cadet and Junior Female	
MKD02996		F	JORDANOSKI KATERINA	Kata Team Cadet and Junior Female	
MKD02995		F	JORDANOSKI MARIJA	Kata Team Cadet and Junior Female	
MKD02995		F	JORDANOSKI MARIJA	Junior Kumite Female -48 kg	
MKD2557		F	KOXHA ERA	U21 Kumite Female -68 kg	
MKD2554		F	MICOVSKA JOVANA	U21 Kumite Female -61 kg	
MKD02992		F	MILANOSKA CVETE	Kata Team Cadet and Junior Female	



EKF Junior, Cadet & U21 Championships 2026 - Lim..



ENTRIES BY NATIONAL FEDERATION

As of 8 FEB 2026

Code	ID	Gender	Name	Event	Seeding
MKD	MKD2406	F	MISHOVSKA MIHAELA	U21 Kumite Female -50 kg	
	MKD003431	F	NIKOLOVA DRAGANA	Cadet Kata Female	
	MKD2582	F	PANCHEVA MILA	U21 Kumite Female -55 kg	
	MKD03250	F	SELA BUNA	Cadet Kumite Female 61+ kg	
	MKD03315	F	SHTERIEVA MILA	Junior Kumite Female -66 kg	
	MKD2387	F	STOJKOVA DANKA	U21 Kata Female	
	MKD03003	F	ZENDELI BLERINA	Junior Kata Female	
	MKD03119	F	ZIBERI ERDONA	U21 Kumite Female 68+ kg	
NOR	NOR02484	M	BERG-ALSTADSAETER PEDER XINGE	U21 Kumite Male -67 kg	
	NOR002903	M	KNUDSEN-TORP WILLIAM	Cadet Kumite Male -52 kg	
	NOR003015	M	MELTZER ISAAC AUGUST	Junior Kata Male	
	NOR002867	F	BRENNE LINNES LEA	Cadet Kumite Female 61+ kg	
	NOR002832	F	OLSEN LINA-VIKTORIA SALES	Junior Kumite Female -59 kg	
	NOR002828	F	OLSENG INGRID	Cadet Kumite Female -54 kg	3
	NOR002975	F	RYBALKO MARINA	Cadet Kumite Female -61 kg	
	NOR02444	F	SJURSEN ALVA ALEXANDRA SIVERTSEN	U21 Kumite Female -55 kg	
NOR002904	F	VUKAJLOVIC EMA	Junior Kumite Female -66 kg		
POL	POL2804	M	BUDNY SZYMON	Cadet Kumite Male -63 kg	
	POL2485	M	DZIUDA DOMINIK	U21 Kumite Male -67 kg	
	POL2493	M	FIEREK JAN	U21 Kumite Male -75 kg	
	POL3959	M	GRZESLO IGOR	Kata Team Cadet and Junior Male	
	POL2909	M	KASPRZAK PASCAL	Junior Kumite Male -68 kg	
	POL2991	M	KIRYLUK PAWEL	U21 Kumite Male 84+ kg	4
	POL06936	M	KOLACKOV LEON	Kata Team Cadet and Junior Male	
	POL06936	M	KOLACKOV LEON	Cadet Kata Male	
	POL3414	M	MYDLARZ MICHAL	Kata Team Cadet and Junior Male	
	POL4137	M	NIEDZIELA MICHAL	Kata Team Cadet and Junior Male	
	POL2951	M	NIEDZIELA WOJCIECH	U21 Kata Male	
	POL2955	M	OLICHWER NATAN	Junior Kumite Male -61 kg	
	POL3965	M	PRZASNYSKI MICHAL	Junior Kumite Male 76+ kg	2
	POL12789	M	SNIEGOCKI SZYMON	Junior Kata Male	
	POL05610	M	WOJARSKI WIKTOR	Junior Kumite Male -76 kg	
	POL2694	M	WOJCIECHOWSKI KACPER	U21 Kumite Male -60 kg	
	POL3106	M	WOZNIAK KAJETAN	U21 Kumite Male -84 kg	
	POL06139	M	ZALESKI ANTONI	Cadet Kumite Male -52 kg	
	POL10977	M	ZGOLA BARTOSZ	Cadet Kumite Male -57 kg	
	POL3560	M	ZYGANOWSKI JAKUB	Junior Kumite Male -55 kg	
	POL3964	F	BALUT NATALIA	Junior Kumite Female 66+ kg	
	POL05545	F	BALUT PATRYCJA	Cadet Kumite Female -54 kg	
	POL3284	F	CICHOSZEWSKA NATASZA	U21 Kumite Female -68 kg	
	POL08881	F	DRONCHANKA KSENIYA	U21 Kumite Female -55 kg	2
	POL06473	F	GARBACIAK GABRIELA	Cadet Kumite Female -47 kg	
	POL04919	F	JEDRZEJEWSKA AMELIA	U21 Kumite Female 68+ kg	
	POL3867	F	KRACZAJ WIKTORIA	Junior Kumite Female -59 kg	
	POL2942	F	LENART LENA	Kata Team Cadet and Junior Female	



EKF Junior, Cadet & U21 Championships 2026 - Lim..



ENTRIES BY NATIONAL FEDERATION

As of 8 FEB 2026

Code	ID	Gender	Name	Event	Seeding
POL	POL06896	F	LEWANDOWSKA KATARZYNA	U21 Kumite Female -61 kg	
	POL2940	F	LYSZKIEWICZ LENA	Kata Team Cadet and Junior Female	
	POL3244	F	MELLER ADRIANNA	Junior Kumite Female -48 kg	
	POL2941	F	MILITOWSKA SARA	Kata Team Cadet and Junior Female	
	POL2810	F	STREUBEL MARTA	Cadet Kata Female	
	POL3395	F	SZUBA NIKOLA	Cadet Kumite Female -61 kg	4
	POL12674	F	WALCZAK KLAUDIA	Junior Kumite Female -66 kg	
	POL3143	F	WASILEWSKA ZUZANNA	U21 Kumite Female -50 kg	
	POL08975	F	WOZNIAK MAJA	Cadet Kumite Female 61+ kg	
	POL2854	F	WYSOCKA EMILIA	U21 Kata Female	
	POL2858	F	ZUREK MILENA	Kata Team Cadet and Junior Female	
	POL2858	F	ZUREK MILENA	Junior Kata Female	
POR	POR003495	M	AGUIAR ANDRE	Junior Kumite Male 76+ kg	
	POR02479	M	ALEXANDRE CARDOSO INACIO DIOGO	U21 Kumite Male -75 kg	
	POR02807	M	CASSAMA JOSE	U21 Kumite Male 84+ kg	
	POR003479	M	CIUNTU DANIEL	Cadet Kumite Male 70+ kg	
	POR003512	M	COSTA DAVID	Junior Kumite Male -68 kg	
	POR003559	M	GARRUCHO SIMAO	Cadet Kumite Male -57 kg	
	POR02720	M	GONCALVES GUILHERME	U21 Kumite Male -67 kg	1
	POR03188	M	JERONIMO VALENTIM	Junior Kumite Male -76 kg	
	POR003494	M	LOPES RODRIGO	Cadet Kumite Male -70 kg	
	SD59627	M	MATEUS VASCO	Kata Team Cadet and Junior Male	4
	SD59627	M	MATEUS VASCO	Junior Kata Male	1
	POR003564	M	MATOS JOAO	U21 Kumite Male -84 kg	
	POR003488	M	MORAIS PEDRO	Cadet Kumite Male -63 kg	
	POR02709	M	OLIVEIRA GUSTAVO	U21 Kumite Male -60 kg	2
	POR03180	M	OLIVEIRA MARTIM	Kata Team Cadet and Junior Male	4
	POR003487	M	REBELO JOAO	Junior Kumite Male -55 kg	
	POR003563	M	SANTOS RUBEN	Cadet Kumite Male -52 kg	
	POR003477	M	SILVA ANTONIO	Kata Team Cadet and Junior Male	4
	POR003474	M	VALENTE SALVADOR	Cadet Kata Male	
	POR003317	M	VALONGO ANDRE	Junior Kumite Male -61 kg	
	POR02704	M	VIEIRA JOAO	U21 Kata Male	
	POR03183	F	BAZYUK VICTORIA	Junior Kumite Female -59 kg	
	POR003352	F	BRANDAUER CHIARA	Cadet Kata Female	
	POR03184	F	CADETE BEATRIZ	Junior Kumite Female -66 kg	
	POR003561	F	CARVALHO ANA	Cadet Kumite Female -47 kg	
	POR02764	F	ECA GUIMARAES MARTA PIMENTA	U21 Kumite Female -55 kg	
	POR03062	F	FLORES EVA	U21 Kumite Female -68 kg	
	POR03182	F	GONCALVES LEONOR	Junior Kumite Female -53 kg	1
	POR02873	F	MARQUES RITA	Junior Kata Female	1
	POR003562	F	MARTINS LIRA	Cadet Kumite Female -54 kg	
	POR003362	F	MATOS ISIS	Junior Kumite Female -48 kg	4
	POR003508	F	MELEIRO BEATRIZ	U21 Kumite Female -50 kg	
	POR03179	F	OLIVEIRA INES	U21 Kata Team Female	
	POR003478	F	PINTO MATILDE	Cadet Kumite Female -61 kg	
	POR02716	F	RIBEIRO BARBARA	U21 Kata Team Female	



EKF Junior, Cadet & U21 Championships 2026 - Lim..



ENTRIES BY NATIONAL FEDERATION

As of 8 FEB 2026

Code	ID	Gender	Name	Event	Seeding
POR	POR003364	F	SANTOS MADALENA	Cadet Kumite Female 61+ kg	1
	POR02707	F	TEIXEIRA LARA	U21 Kata Female	4
	POR02707	F	TEIXEIRA LARA	U21 Kata Team Female	
ROU	ROU03801	M	BARCIU IONUT VALENTIN	Junior Kumite Male 76+ kg	
	ROU02985	M	BUDAN PIRVU PATRICK ALEX	U21 Kumite Male -75 kg	
	ROU03613	M	BUICA MATEI CRISTIAN	Cadet Kumite Male -63 kg	
	ROU03231	M	CRIVAT STEFAN	Junior Kumite Male -68 kg	
	ROU03585	M	DAVID GABRIEL MUTU	Junior Kumite Male -55 kg	
	ROU03715	M	DOLOMAN MIHAI CRISTIAN	Junior Kumite Male -76 kg	
	ROU03605	M	DUMITRU MIRCEA ANDREI	Cadet Kumite Male -57 kg	
	ROU03762	M	HABEANU RARES CRISTIAN	Junior Kata Male	
	ROU02831	M	IANCU DAVID ADRIAN	U21 Kumite Male -67 kg	
	ROU03242	M	IGARELU VICTOR	Cadet Kumite Male 70+ kg	3
	ROU2291	M	IONASCU EDUARD	U21 Kumite Male -84 kg	
	ROU03584	M	MATEI SAVULESCU	Cadet Kumite Male -52 kg	2
	ROU2577	M	MODI ALEXANDRU NICOLAS	U21 Kata Male	
	ROU03620	M	OSTAFIE MANDRES CRISTIAN ANDREI	Cadet Kumite Male -70 kg	
	ROU2438	M	RAZVAN GEORGE FLOREA	Cadet Kata Male	2
	ROU03765	M	TANASE ANDREI	U21 Kumite Male -60 kg	
	ROU02714	M	TONCU CHRISTIAN EDUARD	Junior Kumite Male -61 kg	
	ROU03089	M	VASILE DAVID GABRIEL	U21 Kumite Male 84+ kg	
	ROU03097	F	ADOCHITEI MARIA	U21 Kumite Female 68+ kg	
	ROU03098	F	ANDREI LORELLEY ANISIA	U21 Kumite Female -55 kg	
	ROU03337	F	ANGHEL BIANCA	Junior Kumite Female 66+ kg	
	ROU03577	F	ASABI TIMEEA GAGEA	Junior Kata Female	
	ROU03101	F	BACIU MARIA	U21 Kata Female	
	ROU03737	F	BAICU LORENA MARINA	Junior Kumite Female -48 kg	
	ROU03229	F	BALANESCU IOANA	Cadet Kumite Female -54 kg	1
	ROU03228	F	BALANESCU MARIA	Cadet Kumite Female -47 kg	2
	ROU03095	F	IVASCU LARISA ADRIANA	U21 Kumite Female -68 kg	
	ROU02844	F	LUCESCU ELISABETA	U21 Kumite Female -61 kg	
	ROU003950	F	LUDOVICA CARACAS	Junior Kumite Female -66 kg	
	ROU003857	F	MARIA CARINA POPESCU	Cadet Kumite Female 61+ kg	
	ROU2569	F	NASTAS PATRICIA	U21 Kumite Female -50 kg	3
	ROU03597	F	POPESCU BIANCA	Cadet Kumite Female -61 kg	
	ROU003956	F	SOFIA GHINIA	Junior Kumite Female -53 kg	
	ROU02702	F	SULU KARINA MIHAELA	Junior Kumite Female -59 kg	
	ROU003992	F	VREMAROIU ANAMARIA	Cadet Kata Female	
SCO	SCO02197	M	ANDERSON SCOTT	U21 Kumite Male 84+ kg	
	SCO002733	M	BRODIE CULLEN	Cadet Kumite Male -70 kg	3
	SCO002836	M	FRANCE KYLE	Cadet Kata Male	
	SCO02405	M	FURNESS CAMERON	U21 Kumite Male -84 kg	
	SCO02404	M	GALLAGHER JOE	U21 Kumite Male -67 kg	
	SCO02194	M	HAMILL ADAM	U21 Kumite Male -60 kg	3
	SCO02200	M	PACKWOOD BENJAMIN	U21 Kumite Male -75 kg	
	SCO002913	M	REYNOLDS SONNY	Junior Kumite Male -55 kg	



EKF Junior, Cadet & U21 Championships 2026 - Lim..



ENTRIES BY NATIONAL FEDERATION

As of 8 FEB 2026

Code	ID	Gender	Name	Event	Seeding
SCO	SCO02442	M	WOODS MAX	Junior Kumite Male -61 kg	
	SCO02523	F	BAULD ELIZE	Junior Kumite Female -66 kg	3
	SCO002735	F	CLARK RUBY	Cadet Kumite Female -54 kg	
	SCO002730	F	DUFF JULIA	Cadet Kumite Female -61 kg	
	SCO02409	F	EWING MAIA	Junior Kumite Female 66+ kg	3
	SCO02195	F	FITAL KORI	U21 Kumite Female -68 kg	
	SCO002914	F	WALKER LUCY	Cadet Kumite Female 61+ kg	
SRB	SRB04204	M	AVRAMOVIC STRAHINJA	Junior Kumite Male -61 kg	
	SRB2536	M	BOSKOV ALEKSANDAR	U21 Kata Male	
	SRB2536	M	BOSKOV ALEKSANDAR	U21 Kata Team Male	
	SRB03721	M	GREB ANDRIJA	Cadet Kata Male	
	SRB03746	M	HORVAT TODOR	Cadet Kumite Male -52 kg	4
	SRB004537	M	ISAK SERGEJ	Cadet Kumite Male -70 kg	
	SRB2565	M	JAKOVLJEVIC VASILIJJE	U21 Kata Team Male	
	SRB03032	M	JOKIC STRAHINJA	Cadet Kumite Male 70+ kg	
	SRB03370	M	KAPLAREVIC NIKOLA	Junior Kumite Male -76 kg	
	SRB03771	M	LONCAREVIC VUK	Kata Team Cadet and Junior Male	
	SRB03467	M	MAKSIC VUKASIN	Kata Team Cadet and Junior Male	
	SRB004825	M	MARIC DANILO	U21 Kumite Male -75 kg	
	SRB03382	M	MARKOVIC VUK	Cadet Kumite Male -63 kg	
	SRB03108	M	MILASINOVIC UROS	U21 Kata Team Male	
	SRB02982	M	MILENKOVIC BOGDAN	U21 Kumite Male -60 kg	
	SRB2541	M	MILOSEVIC ILIJA	U21 Kumite Male -84 kg	
	SRB03744	M	MILUTINOVIC MARKO	Junior Kumite Male -68 kg	
	SRB2468	M	PAUNOVIC DJORDJE	Junior Kata Male	
	SRB2494	M	PEJOVIC UGLJESA	U21 Kumite Male 84+ kg	
	SRB03733	M	POPOVIC JOVAN	Cadet Kumite Male -57 kg	
	SRB03783	M	STOJANOVIC FILIP	Kata Team Cadet and Junior Male	
	SRB2800	M	VILOTIJEVIC ANDREJ	Junior Kumite Male 76+ kg	
	SRB2682	M	VRZIC MISO	U21 Kata Team Male	
	SRB03007	M	VUCKOVIC ALEKSANDAR	U21 Kumite Male -67 kg	
	SRB03779	F	ARSIC TEODORA	Kata Team Cadet and Junior Female	
	SRB03779	F	ARSIC TEODORA	Cadet Kata Female	
	SRB02988	F	BANKOVIC DANICA	Junior Kumite Female -53 kg	
	SRB2486	F	COSO ANJA	U21 Kumite Female -50 kg	
	SRB2340	F	FILIPOV NEVENA	U21 Kumite Female -61 kg	
	SRB03480	F	GRUJANIC IRENA	Kata Team Cadet and Junior Female	
	SRB03577	F	KRSTOVIC TEODORA	U21 Kumite Female -68 kg	
	SRB03513	F	MACURA NINA	Cadet Kumite Female 61+ kg	
	SRB03471	F	MANOJLOVIC ANA	Junior Kumite Female -66 kg	
	SRB04016	F	MARTAC SOFIJA	Cadet Kumite Female -47 kg	
	SRB004837	F	MILOJEVIC STASA	Junior Kumite Female 66+ kg	
	SRB03033	F	MILOSEVIC NEDA	U21 Kata Female	
	SRB04113	F	NIKOLIC NATASA	Cadet Kumite Female -61 kg	
	SRB03831	F	RADOVIC IRINA	Junior Kumite Female -59 kg	
	SRB2507	F	RAJIC DUNJA	U21 Kumite Female 68+ kg	
	SRB004836	F	STEVANOVIC ANJA	Junior Kumite Female -48 kg	



EKF Junior, Cadet & U21 Championships 2026 - Lim..



ENTRIES BY NATIONAL FEDERATION

As of 8 FEB 2026

Code	ID	Gender	Name	Event	Seeding
SRB	SRB03388	F	TRIKOS MILICA	Cadet Kumite Female -54 kg	
	SRB03069	F	VALASEK NADJA	Kata Team Cadet and Junior Female	
SVK	SVK003446	M	BABEL BRANISLAV	Kata Team Cadet and Junior Male	
	SVK02638	M	BOHUNICKY LUKAS	U21 Kumite Male -84 kg	
	SD48713	M	CHRENKO JAN	U21 Kumite Male -60 kg	
	SVK003250	M	FOLTIN MILAN	Cadet Kumite Male -70 kg	
	SVK02796	M	GENDES DAVID	Junior Kata Male	
	SVK02653	M	IVANCIK OLIVER	U21 Kumite Male -67 kg	
	SVK2210	M	KODAJ SIMON	U21 Kata Male	
	SVK003403	M	KOVACIK SIMON	Cadet Kumite Male -57 kg	3
	SVK003249	M	KOVAL DAVID	Cadet Kumite Male -63 kg	
	SVK02722	M	KRALIK TOMAS	U21 Kumite Male 84+ kg	
	SVK003399	M	MACKO PETER	Kata Team Cadet and Junior Male	
	SVK003399	M	MACKO PETER	Cadet Kata Male	
	SVK003402	M	MARCINEK MAXIM	Cadet Kumite Male -52 kg	
	SVK003254	M	MITRIK RICHARD	Cadet Kumite Male 70+ kg	1
	SVK003251	M	NANO TOMAS	Junior Kumite Male 76+ kg	
	SVK003447	M	ORAVCIK JURAJ	Kata Team Cadet and Junior Male	
	SVK003406	M	PASNISIN MAROS	Junior Kumite Male -68 kg	
	SVK03132	M	PLICHTA BRUNO	Junior Kumite Male -61 kg	
	SVK02501	M	SECKAR SIMON	U21 Kumite Male -75 kg	
	SVK003448	M	STUSKA SAMUEL	Kata Team Cadet and Junior Male	
	SVK02875	M	TURCANIK RICHARD	Junior Kumite Male -76 kg	4
	SVK003405	M	ZABKA OLIVER	Junior Kumite Male -55 kg	
	SVK003247	F	BENESOVA NINA	Junior Kumite Female -59 kg	
	SVK003451	F	BIROVA EMMA	Cadet Kumite Female -47 kg	
	SVK03126	F	FIALKOVA SOFIA	Junior Kata Female	4
	SVK003246	F	GASPAROVA JESSICA	Cadet Kumite Female -61 kg	2
	SVK003407	F	HAJDUKOVA JANA	U21 Kumite Female 68+ kg	
	SVK03128	F	ILAVSKA KRISTINA	Junior Kumite Female -53 kg	
	SVK02760	F	KADLECAJOVA VIKTORIA	U21 Kata Female	
	SVK02759	F	KALAMAROVA ALEXANDRA	U21 Kumite Female -68 kg	
	SVK003449	F	KEMENYIKOVA DOMINIKA	Kata Team Cadet and Junior Female	
	SVK003244	F	KISSKOVA KAROLINA	Cadet Kata Female	4
	SVK003244	F	KISSKOVA KAROLINA	Kata Team Cadet and Junior Female	
	SVK003450	F	KLEMPOVA LAURA	Kata Team Cadet and Junior Female	
	SVK003404	F	KULIKOVA VIRA	Junior Kumite Female 66+ kg	
	SVK02345	F	KVASNICOVA NINA	U21 Kumite Female -55 kg	1
	SVK02627	F	MALA LILIANA	U21 Kumite Female -50 kg	
	SVK03009	F	MIERNA ADRIANA	Junior Kumite Female -48 kg	
	SVK003452	F	SEVCIKOVA VIKTORIA	Cadet Kumite Female 61+ kg	
	SVK003245	F	STREICHEROVA ROMANA	Cadet Kumite Female -54 kg	
	SVK02426	F	VACZY ANNA	U21 Kumite Female -61 kg	3
	SVK02805	F	ZEUMEROVA ALEXANDRA	Junior Kumite Female -66 kg	2
SLO	SLO02891	M	BAUMAN GAL	Junior Kumite Male -76 kg	
	SLO02796	M	CICVARIC LUKA	Junior Kata Male	
	SLO03039	M	GACIC ALEKSANDER	Junior Kumite Male 76+ kg	



EKF Junior, Cadet & U21 Championships 2026 - Lim..



ENTRIES BY NATIONAL FEDERATION

As of 8 FEB 2026

Code	ID	Gender	Name	Event	Seeding
SLO	SLO02835	M	OVNIC TIAN	Cadet Kata Male	
	SLO003053	M	SEDONJA MATIJA	Junior Kumite Male -68 kg	
	SLO2427	M	ZARIC VID	U21 Kumite Male -67 kg	
	SLO2443	M	ZIBRET BOR	U21 Kumite Male -75 kg	
	SLO02759	F	CERU JERNEJA	U21 Kumite Female -68 kg	
	SLO02695	F	IVANCIC KIARA	Cadet Kumite Female -54 kg	
	SLO02831	F	JERSIC ZANA	Kata Team Cadet and Junior Female	
	SLO02940	F	KRAMAR LILI	Kata Team Cadet and Junior Female	
	SLO02926	F	KREGAR GABRIELA	Junior Kata Female	
	SLO02926	F	KREGAR GABRIELA	Kata Team Cadet and Junior Female	
	SLO03048	F	KRISTANCIC ZIVA	Junior Kumite Female 66+ kg	
	SLO02690	F	KRVINA LIA	Junior Kumite Female -59 kg	
	SLO02712	F	LEBEN TINKARA	U21 Kumite Female -55 kg	
	SLO2423	F	LISINOVIC ELMA	U21 Kata Female	
	SLO02855	F	MASTNAK MIA	Cadet Kumite Female -61 kg	
	SLO02719	F	MAVSAR TAJDA	Kata Team Cadet and Junior Female	
	SLO02705	F	MEDIC ADELA	Junior Kumite Female -66 kg	
	SLO02570	F	PISNIK MAJA-MARI	Cadet Kata Female	
ESP	ESP004315	M	ALVAREZ FERNANDEZ IZAN	Kata Team Cadet and Junior Male	
	ESP004299	M	ARRIBAS JIMENEZ OSCAR	Cadet Kumite Male -57 kg	
	ESP004281	M	BLANCO CASTRO MARCOS	Cadet Kumite Male -70 kg	
	ESP004414	M	CARMONA DIAZ ENRIQUE	Kata Team Cadet and Junior Male	
	ESP03892	M	DIEGO ROLDAN RUBEN	Junior Kumite Male -76 kg	
	ESP03013	M	GALAN LACON ALEJANDRO	U21 Kata Team Male	
	ESP03599	M	GARCIA DE BLAS REDONDO RODRIGO	Cadet Kumite Male -63 kg	2
	ESP03607	M	GOMEZ MAURINO DAVID	Junior Kumite Male -55 kg	
	ESP004284	M	GONZALEZ SAEZ HUGO	Kata Team Cadet and Junior Male	
	ESP004284	M	GONZALEZ SAEZ HUGO	Cadet Kata Male	3
	ESP02882	M	HURTADO CANIZO SAMUEL	U21 Kumite Male 84+ kg	
	ESP004413	M	JACOBO CASADO FERNANDEZ	Cadet Kumite Male 70+ kg	
	ESP02555	M	JIMENEZ DIAZ ALEJANDRO	U21 Kumite Male -84 kg	
	ESP004094	M	LEON DE LA PENA JOSE ANGEL	Junior Kata Male	3
	ESP004094	M	LEON DE LA PENA JOSE ANGEL	Kata Team Cadet and Junior Male	
	ESP004317	M	LEON MUNOZ OIER	Junior Kumite Male -68 kg	
	ESP004375	M	LOPEZ PEREZ HUGO	Cadet Kumite Male -52 kg	
	ESP03228	M	LOPEZ TOMAS IZAN	U21 Kata Team Male	
	ESP004093	M	LOPEZ VILLANUEVA JUAN MANUEL	U21 Kata Team Male	
	ESP03893	M	MANSO ARNAL ADRIAN	Junior Kumite Male -61 kg	
	ESP02671	M	MARTIN MONTENEGRO IVAN	U21 Kata Team Male	
	ESP02671	M	MARTIN MONTENEGRO IVAN	U21 Kata Male	
	ESP03305	M	PEREZ LORITE JORGE	U21 Kumite Male -60 kg	
	ESP02880	M	PIRIS FERRER MIGUEL	U21 Kumite Male -67 kg	
	ESP02554	M	SHOTTE CABELLO ZSAMORAN	U21 Kumite Male -75 kg	
	ESP03481	M	STOIA ONU PAUL GABRIEL	Junior Kumite Male 76+ kg	
	ESP004097	F	ANGULO MADRID ABRIL	U21 Kata Team Female	
	ESP004415	F	AYERDI ARIZ NAROA	Junior Kumite Female -53 kg	
	ESP004279	F	CASTRO LOPEZ ROCIO	Junior Kata Female	



EKF Junior, Cadet & U21 Championships 2026 - Lim..



ENTRIES BY NATIONAL FEDERATION

As of 8 FEB 2026

Code	ID	Gender	Name	Event	Seeding
ESP	ESP004279	F	CASTRO LOPEZ ROCIO	Kata Team Cadet and Junior Female	2
	ESP03601	F	CHICA TOLOSA ARIADNA	Cadet Kumite Female -54 kg	
	ESP003965	F	FOLGUEIRA GONZALEZ UXIA	Kata Team Cadet and Junior Female	2
	ESP02672	F	GARCIA LOZANO PAOLA	U21 Kata Female	1
	ESP02672	F	GARCIA LOZANO PAOLA	U21 Kata Team Female	
	ESP003963	F	GARCIA RUIZ NADIRA	Cadet Kumite Female -47 kg	4
	ESP03602	F	GINES CHAVARRY PAULA	Cadet Kumite Female -61 kg	
	ESP03884	F	GOMEZ MAURINO ALEJANDRA	Junior Kumite Female -59 kg	
	ESP003979	F	GUARDENO LEON CARLA	U21 Kata Team Female	
	ESP03479	F	JUST CLOPES JULIA	U21 Kumite Female -68 kg	
	ESP03891	F	LARRA PARDO SARA	U21 Kumite Female 68+ kg	
	ESP004412	F	LOPEZ ARANDA EVA	U21 Kumite Female -55 kg	
	ESP003967	F	LOPEZ GONZALEZ NOA	Junior Kumite Female -66 kg	
	ESP004276	F	MARTIN DIAZ ALBA	U21 Kata Team Female	
	ESP004323	F	NUNEZ ABREU NAGORE	Cadet Kumite Female 61+ kg	
	ESP03038	F	OTERO LUENGO EVA	U21 Kumite Female -61 kg	4
	ESP003969	F	PACHECO PALOMARES MARIA	Junior Kumite Female -48 kg	
	ESP004148	F	PENA GARCIA CANDELA	Cadet Kata Female	
	ESP004148	F	PENA GARCIA CANDELA	Kata Team Cadet and Junior Female	2
	ESP03591	F	RAMIREZ GRANDE ERIKA	Junior Kumite Female 66+ kg	
	ESP004095	F	RODRIGO DIAZ LUCIA	Kata Team Cadet and Junior Female	2
	ESP02675	F	VIZUETE OLIVENZA MIREIA	U21 Kumite Female -50 kg	4
	SWE	SWE003400	M	ALFREDSSON JOEL	Cadet Kumite Male 70+ kg
SWE003401		M	ANDERSSON EMIL	Cadet Kumite Male -63 kg	
SWE02691		M	BECHTIOUI TAHA	U21 Kumite Male -60 kg	
SWE003396		M	BOUGHIOU TOUFFIK	Junior Kumite Male -61 kg	
SWE003399		M	DAOUD ADAM	Cadet Kumite Male -57 kg	
SWE003398		M	DURLING CHARLIE	Cadet Kumite Male -52 kg	
SWE02427		M	HAAG OZZY	U21 Kumite Male -84 kg	
SWE003127		M	HASSAS JACOB	Junior Kumite Male -76 kg	
SWE003124		M	JONASSON JAKOB	Junior Kata Male	
SWE003236		M	MUSTAFA JOSEF	Junior Kumite Male -55 kg	
SWE003122		M	NASER AHMED	U21 Kumite Male -67 kg	
SWE02584		M	VU ANTHONY	U21 Kata Male	1
SWE003397		F	ASLAM ZOHA ZAHEER	Cadet Kumite Female -47 kg	
		F	GULLAN SOFIA HELENA ENGMAN	U21 Kumite Female 68+ kg	
SWE003350		F	JAKESEVIC IVANA	U21 Kumite Female -68 kg	
SWE003356		F	KHASHAN ILAF	Junior Kumite Female -59 kg	
SWE003353		F	LARSSON ERHARDT SIGNE	Cadet Kumite Female -54 kg	
SWE003402		F	NYBERG STELLA	U21 Kata Female	
SWE02686		F	NYMAN AGNES	U21 Kumite Female -50 kg	
SWE003276		F	ROTH ALMA	Cadet Kata Female	
SWE003352	F	VAPPER MINOU	Junior Kata Female		
SUI	SUI003763	M	ALVES DA GLORIA PATRICK	Junior Kumite Male -55 kg	
	SUI02692	M	BANDELIER MATHIS	U21 Kumite Male 84+ kg	
	SUI004974	M	BAUMGARTNER CEBRAIL	Cadet Kumite Male -70 kg	
	SUI02742	M	BUHURCU JIYAN	Junior Kumite Male 76+ kg	



EKF Junior, Cadet & U21 Championships 2026 - Lim..



ENTRIES BY NATIONAL FEDERATION

As of 8 FEB 2026

Code	ID	Gender	Name	Event	Seeding
SUI	SUI02276	M	JOST RUBEN	U21 Kumite Male -60 kg	
	SUI02682	M	KABASHI ELSON JASON	U21 Kumite Male -75 kg	
	SUI02734	M	KARLEN THEO	Junior Kumite Male -68 kg	4
	SUI02269	M	LORENZ SWAN	U21 Kumite Male -67 kg	
	SUI003341	M	LUETHY CORSIN DION	Cadet Kumite Male -52 kg	
	SUI003341	M	LUETHY CORSIN DION	Cadet Kata Male	4
	SUI02697	M	PEDRO THEO	U21 Kumite Male -84 kg	
	SUI003155	M	PETRONE LEANDRO	U21 Kata Male	
	SUI02743	M	SCHEDEL NOLAN	Junior Kata Male	
	SUI003706	M	SOLIARYK PLATON	Junior Kumite Male -76 kg	
	SUI004975	M	TIEFENAUER JONATHAN	Cadet Kumite Male -63 kg	
	SUI03114	M	ZECCA LUCAS	Junior Kumite Male -61 kg	
	SUI003192	F	ARIFAGIC ALMINA	Junior Kumite Female -66 kg	
	SUI02568	F	BONNY SHANIA	U21 Kumite Female 68+ kg	
	SUI004973	F	BUERKI DANICHA	U21 Kumite Female -61 kg	
	SUI03112	F	DUMITRAS PIA	Junior Kumite Female -53 kg	
	SUI03111	F	OEZDEMIR DEMET	Junior Kumite Female -48 kg	
	SUI004454	F	OYMAK ALMINA	Cadet Kumite Female -47 kg	
	SUI03113	F	REDZIC ESMA	Junior Kumite Female 66+ kg	
	SUI02740	F	RITZ LILA	Junior Kata Female	
	SUI02740	F	RITZ LILA	Kata Team Cadet and Junior Female	
	SUI02739	F	RITZ MAIA	Kata Team Cadet and Junior Female	
	SUI003225	F	SCHEDEL KAENA	Cadet Kata Female	
	SUI004380	F	SIGILLO ANASTASIA	Kata Team Cadet and Junior Female	
	SUI02566	F	STREIT KIM LARA	U21 Kumite Female -55 kg	
	SUI02602	F	WYSSBROD SELIN	U21 Kumite Female -50 kg	
	UKR	UKR003916	M	BAIOL MYKOLA	Cadet Kumite Male 70+ kg
UKR003686		M	DAVYDIUK HLIEB	Kata Team Cadet and Junior Male	
UKR003913		M	DOROSH MARK	Cadet Kumite Male -52 kg	
UKR003918		M	KOSTENCHUK DANYLO	Junior Kumite Male -61 kg	
UKR02868		M	KOZYLIAN OLEKSANDR	U21 Kumite Male 84+ kg	
UKR003927		M	MAKSYMENKO KIRIL	Kata Team Cadet and Junior Male	
UKR003919		M	MATSERUK OLEKSANDR	Junior Kumite Male -76 kg	
UKR003915		M	NEVOZHAI MAKSYM	Junior Kata Male	
UKR003917		M	PETROV SERHII	Cadet Kumite Male -70 kg	
UKR02970		M	PIANTKIVSKYI DENYS	U21 Kumite Male -84 kg	
UKR02683		M	PITSUL HEORHII	U21 Kumite Male -75 kg	1
UKR03066		M	PRANNYCHUK NAZARII	U21 Kumite Male -67 kg	
UKR003914		M	REPCHUK ANDRII	Cadet Kumite Male -63 kg	
UKR003730		M	RUDENKO VLADYSLAV	Junior Kumite Male 76+ kg	4
UKR03385		M	SEMENENKO NIKITA	U21 Kata Male	
UKR003923		M	SHEVCHENKO STANISLAV	Cadet Kumite Male -57 kg	
UKR003922		M	SOKHA NAZAR	U21 Kumite Male -60 kg	
UKR03565		M	STANKOV SERHII	Junior Kumite Male -68 kg	
UKR003683		M	TATARYN NAZAR	Kata Team Cadet and Junior Male	
UKR003683		M	TATARYN NAZAR	Cadet Kata Male	
UKR03559	M	VIECHKANOV MAKSYM	Junior Kumite Male -55 kg	1	



EKF Junior, Cadet & U21 Championships 2026 - Lim..



ENTRIES BY NATIONAL FEDERATION

As of 8 FEB 2026

Code	ID	Gender	Name	Event	Seeding	
UKR	UKR03150	F	BARANOVA ULIANA	Junior Kumite Female -66 kg	4	
	UKR03150	F	BARANOVA ULIANA	Junior Kata Female		
	UKR02864	F	BULAY DARIIA	U21 Kumite Female 68+ kg	3	
	UKR003680	F	CHUMAK ALIKA	Cadet Kumite Female 61+ kg		
	UKR003920	F	ELII SOFIIA	Cadet Kumite Female -54 kg	2	
	UKR003742	F	GOLOD ANASTASIIA	U21 Kata Female		
	UKR03561	F	HNES MARIIA	Junior Kumite Female -53 kg		
	UKR02873	F	KHOMENKO DARIA	U21 Kumite Female -50 kg		
	UKR003729	F	KOSHEL SOFIYA	U21 Kumite Female -55 kg		
	UKR003728	F	KOTENKO VIERONIKA	Junior Kumite Female -48 kg		2
	UKR003924	F	MAISTRENKO HANNA	Cadet Kumite Female -47 kg		
	UKR03090	F	MAKARENKO VIOLETTA	U21 Kumite Female -61 kg		
	UKR003921	F	POPOVA DIANA	Cadet Kumite Female -61 kg		
	UKR03314	F	PUSHKOVA ANASTASIIA	Junior Kumite Female -59 kg		
	UKR003925	F	SHCHERBININA ANASTASIIA	Cadet Kata Female		
	UKR003926	F	TROFYMENKO SOFIIA	Junior Kumite Female 66+ kg		
UKR02922	F	VOLOSHYN SOLOMIIA	U21 Kumite Female -68 kg			
WAL	WAL002521	M	BEARDS JAMES	U21 Kata Male		
	WAL02264	M	LAWRENCE ALEXANDER	U21 Kumite Male -84 kg		
	WAL002520	M	MAJOR EMMANUEL	Junior Kata Male		
	WAL02302	M	PHILLIPS LOGAN	Junior Kumite Male 76+ kg		
	WAL002519	F	BURGESS TIANNA	Cadet Kumite Female -47 kg		
	WAL02416	F	JONES ELEANOR	U21 Kumite Female -55 kg		
	WAL002451	F	REES MAIDIE	Junior Kumite Female -59 kg		
WKF-1	WKF-100679 7	M	ALMEKHAMETOV EMIL	Cadet Kumite Male -63 kg		
	WKF-100680 2	M	ANUCHIN ALEKSANDR	Kata Team Cadet and Junior Male		
	RUS04232	M	ANUCHIN PAVEL	U21 Kata Male		
	AIN-100635 5	M	BAKIROV ELSHAN	Junior Kata Male		
	AIN-100650 1	M	DMITRIEV VIACHESLAV	U21 Kumite Male -60 kg		
	RUS04506	M	GADZHIEV GADZHI	U21 Kumite Male -75 kg		
	AIN-100652 5	M	GRISHKIN EGOR	Cadet Kumite Male -70 kg		
	WKF-100680 9	M	KALMYKOV ILIA	Junior Kumite Male 76+ kg		
	AIN-100649 6	M	KEBISHEV ISLAM	U21 Kumite Male -67 kg		
	WKF-100680 1	M	KONDYBAEV NIKITA	Kata Team Cadet and Junior Male		
	WKF-100680 8	M	LIKHANOV ANDREI	Junior Kumite Male -68 kg		
	WKF-100678 2	M	MAGOMEDALIEV ABDULKADIR	Junior Kumite Male -76 kg		
	AIN-100666 9	M	MAGOMEDOV GADZHILAV	U21 Kumite Male -84 kg		
	WKF105719	M	MAKSIMOV ALEXANDR	Cadet Kumite Male 70+ kg		



EKF Junior, Cadet & U21 Championships 2026 - Lim..



ENTRIES BY NATIONAL FEDERATION

As of 8 FEB 2026

Code	ID	Gender	Name	Event	Seeding
WKF-1	AIN-100647 4	M	MIRONOV ALEKSANDR	Cadet Kata Male	
	WKF105312	M	PEREVOZCHIKOV TIMUR	Cadet Kumite Male -52 kg	
	AIN-100636 4	M	RAIZER ARSENI	Junior Kumite Male -61 kg	
	WKF-100680 7	M	SOKOLOV KIRILL	Cadet Kumite Male -57 kg	
	AIN-100635 0	M	TEKUEV ALYI	Junior Kumite Male -55 kg	
	WKF-100679 4	M	VLADIMIROV SAVELII	Kata Team Cadet and Junior Male	
	WKF-100680 4	M	ZHIRNOV NIKITA	Kata Team Cadet and Junior Male	
	AIN-100634 2	F	AVANESOVA VERONIKA	Kata Team Cadet and Junior Female	
	AIN-100634 2	F	AVANESOVA VERONIKA	Cadet Kata Female	
	RUS04485	F	BASANGOVA ALTANA	U21 Kumite Female -61 kg	
	AIN-100643 8	F	BIKMETOVA AIDA	U21 Kumite Female -68 kg	
	WKF105903	F	BORISOVA ALEKSANDRA	Cadet Kumite Female -47 kg	
	WKF105721	F	DANILOVA SOFIA	Cadet Kumite Female 61+ kg	
	WKF105405	F	DAVYDOVA VICTORIA	U21 Kumite Female -50 kg	
	AIN-100641 3	F	GASHNIKOVA VERONIKA	Junior Kumite Female -53 kg	3
	WKF-100680 5	F	KALOEVA KIRA	Cadet Kumite Female -54 kg	
	WKF-100680 3	F	KHOSROEVA ALINA	Kata Team Cadet and Junior Female	
	AIN-100647 1	F	KRAPIVINA KIRA	Junior Kumite Female 66+ kg	
	WKF-100679 9	F	LEONOVA VARVARA	Junior Kumite Female -48 kg	
	AIN-100646 0	F	MILOVANOVA VALERIIA	Junior Kumite Female -66 kg	
	WKF-100680 0	F	NEMCHENKO ANGELINA	Kata Team Cadet and Junior Female	
	WKF-100679 8	F	NIKOLAEVA NATALIA	Junior Kata Female	
	AIN-100634 3	F	NOVICIKHINA ELENA	U21 Kata Female	
	WKF-100679 6	F	OCHIROVA SAGLARA	Junior Kumite Female -59 kg	
	WKF-100679 5	F	PANTILEEVA ELIZAVETA	Kata Team Cadet and Junior Female	
	RUS03672	F	SHISHOVA KSENIYA	U21 Kumite Female 68+ kg	
	WKF105251	F	VOLIK ANNA	Cadet Kumite Female -61 kg	
	AIN-100666 7	F	ZVIAGINTSEVA OLGA	U21 Kumite Female -55 kg	
WKF-2	AIN-200277 7	M	BAHAMOLETS MIKITA	U21 Kumite Male -67 kg	
	AIN-200284 9	M	KAPANITSA YAGOR	Junior Kumite Male -55 kg	



EKF Junior, Cadet & U21 Championships 2026 - Lim..



ENTRIES BY NATIONAL FEDERATION

As of 8 FEB 2026

Code	ID	Gender	Name	Event	Seeding
WKF-2	AIN-200277 8	M	KUDZINAU IVAN	U21 Kumite Male 84+ kg	
	AIN-200279 2	F	LABATSEVICH ALINA	Junior Kumite Female -59 kg	
	BLR02353	F	MALAKHAVA MARYIA	U21 Kumite Female 68+ kg	
	BLR02396	F	MARKAVA ULYANA	U21 Kumite Female -50 kg	
	WKF-200298 0	F	POLUKHLEB KSENIYA	Junior Kumite Female -66 kg	
	AIN-200277 6	F	RUDZENCHANKA VIKTORYIA	Junior Kata Female	

STATISTICS



Statistics

Participating Countries: 46

	Competitors	Entries
Female	559	529
Male	636	607
Total	1195	1136

Entries per Category	Entries	Teams
Cadet Kata Female	27	-
Cadet Kata Male	30	-
Cadet Kumite Female -47 kg	32	-
Cadet Kumite Female -54 kg	36	-
Cadet Kumite Female -61 kg	34	-
Cadet Kumite Female 61+ kg	30	-
Cadet Kumite Male -52 kg	33	-
Cadet Kumite Male -57 kg	30	-
Cadet Kumite Male -63 kg	30	-
Cadet Kumite Male -70 kg	30	-
Cadet Kumite Male 70+ kg	27	-
Junior Kata Female	29	-
Junior Kata Male	34	-
Junior Kumite Female -48 kg	27	-
Junior Kumite Female -53 kg	29	-
Junior Kumite Female -59 kg	38	-
Junior Kumite Female -66 kg	35	-
Junior Kumite Female 66+ kg	27	-
Junior Kumite Male -55 kg	31	-
Junior Kumite Male -61 kg	37	-
Junior Kumite Male -68 kg	40	-
Junior Kumite Male -76 kg	38	-
Junior Kumite Male 76+ kg	34	-
Kata Team Cadet and Junior Female	-	15
Kata Team Cadet and Junior Male	-	13
U21 Kata Female	28	-
U21 Kata Male	29	-
U21 Kata Team Female	-	6
U21 Kata Team Male	-	7
U21 Kumite Female -50 kg	27	-
U21 Kumite Female -55 kg	29	-



Statistics

U21 Kumite Female -61 kg	25	-
U21 Kumite Female -68 kg	30	-
U21 Kumite Female 68+ kg	25	-
U21 Kumite Male -60 kg	31	-
U21 Kumite Male -67 kg	38	-
U21 Kumite Male -75 kg	34	-
U21 Kumite Male -84 kg	33	-
U21 Kumite Male 84+ kg	28	-
Totals:	1095	41

CADET KATA FEMALE



EKF Junior, Cadet & U21 Championships 2026 - Lim..



ENTRIES BY WEIGHT CATEGORY

Cadet Kata Female

As of 8 FEB 2026

Code	ID	Gender	Name	Seeding
BIH	BIH03704	F	BASAGIC EDNA	
CRO	CRO004263	F	SABOL MIA	
CYP	CYP003241	F	NICOLAOU KALLIOPI	
DEN	DEN002949	F	MALTE BAKKE CAMMA	
ESP	ESP004148	F	PENA GARCIA CANDELA	
FIN	FIN002824	F	WANIC MARIE	
FRA	FRA004504	F	CAYLA ANAIS	
GER	GER004012	F	GOETHE MARIEL	1
GRE	GRE03415	F	BOUGIOUKLAKI SPYRIDOULA	
HUN	HUN03073	F	BENKO SZONJA LOLA	
ITA	ITA005922	F	BERETTA MARTINA	3
LAT	LAT002972	F	IVANOVA AURELIJA	
LTU	LTU002733	F	BRUNIUTE ERIKA	
LUX	LUX02677	F	BRESER ANASTASIA	
MKD	MKD003431	F	NIKOLOVA DRAGANA	
MLT	MLT02238	F	AWAD ATTIA JENNA	2
MNE	MNE02598	F	BELJKAS NEDA	
POL	POL2810	F	STREUBEL MARTA	
POR	POR003352	F	BRANDAUER CHIARA	
ROU	ROU003992	F	VREMAROIU ANAMARIA	
SLO	SLO02570	F	PISNIK MAJA-MARI	
SRB	SRB03779	F	ARSIC TEODORA	
SUI	SUI003225	F	SCHEDDEL KAENA	
SVK	SVK003244	F	KISSKOVA KAROLINA	4
SWE	SWE003276	F	ROTH ALMA	
UKR	UKR003925	F	SHCHERBININA ANASTASIIA	
WKF-1	AIN-1006342	F	AVANESOVA VERONIKA	

Cadet Kata Female

EKF Junior, Cadet & U21 Championships 2026 - Limassol, Spyros Kyprianou Athletic Center, Limassol, CYP

2026-02-06

Tatami
1 09:00

Pool
1/4



WKF
EUROPE

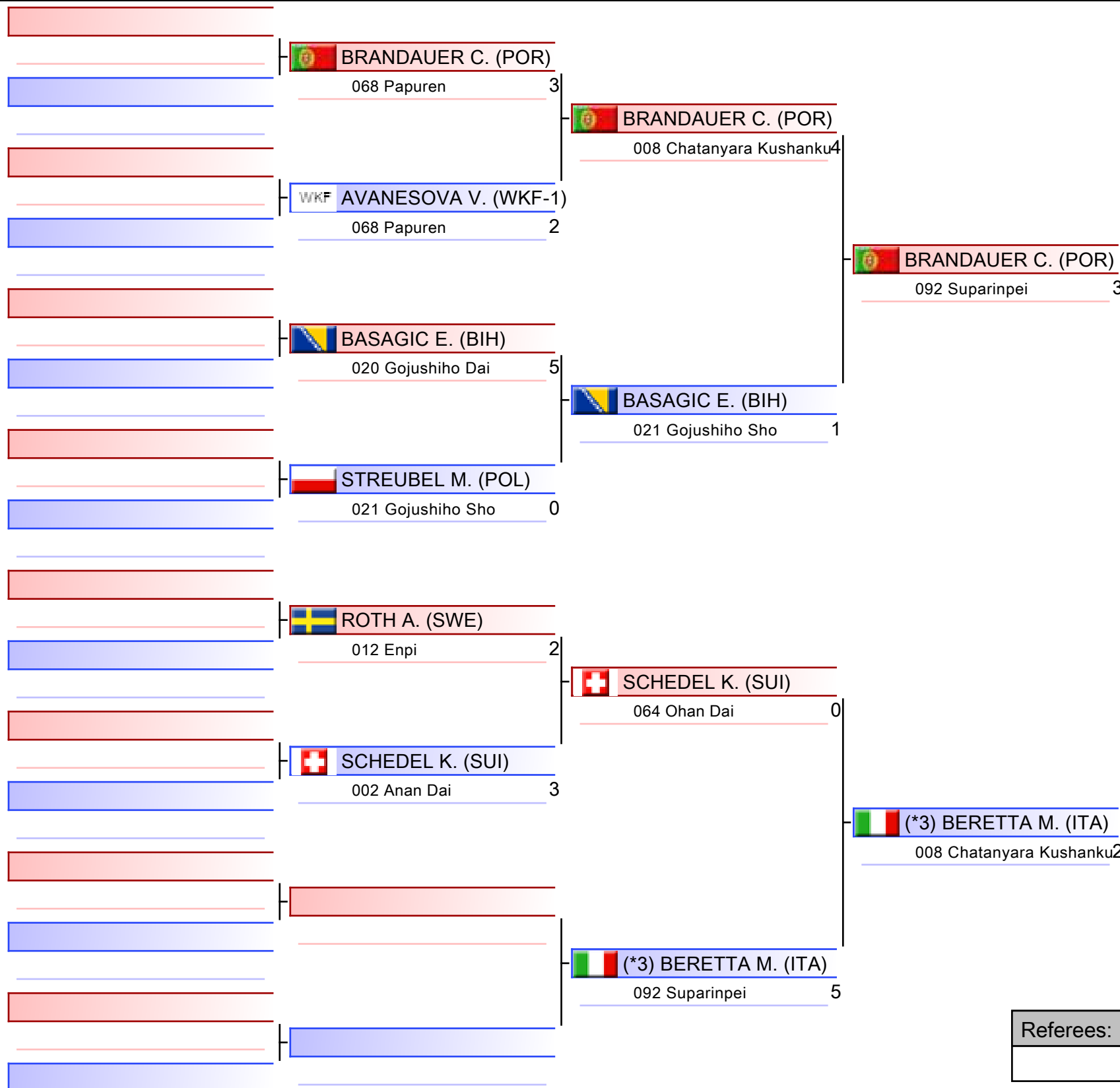

1. PENA GARCIA CANDELA (ESP)
2. BELJKAS NEDA (MNE)
3. GOETHE MARIEL (GER)
3. BRANDAUER CHIARA (POR)
5. BENKO SZONJA LOLA (HUN)
5. AWAD ATTIA JENNA (MLT)
7. KISSKOVA KAROLINA (SVK)
7. CAYLA ANAIS (FRA)

*Seeded

Referees:			

Cadet Kata Female

EKF Junior, Cadet & U21 Championships 2026 - Limassol, Spyros Kyprianou Athletic Center, Limassol, CYP

2026-02-06

Tatami
2 09:00

Pool
2/4



WKF
EUROPE

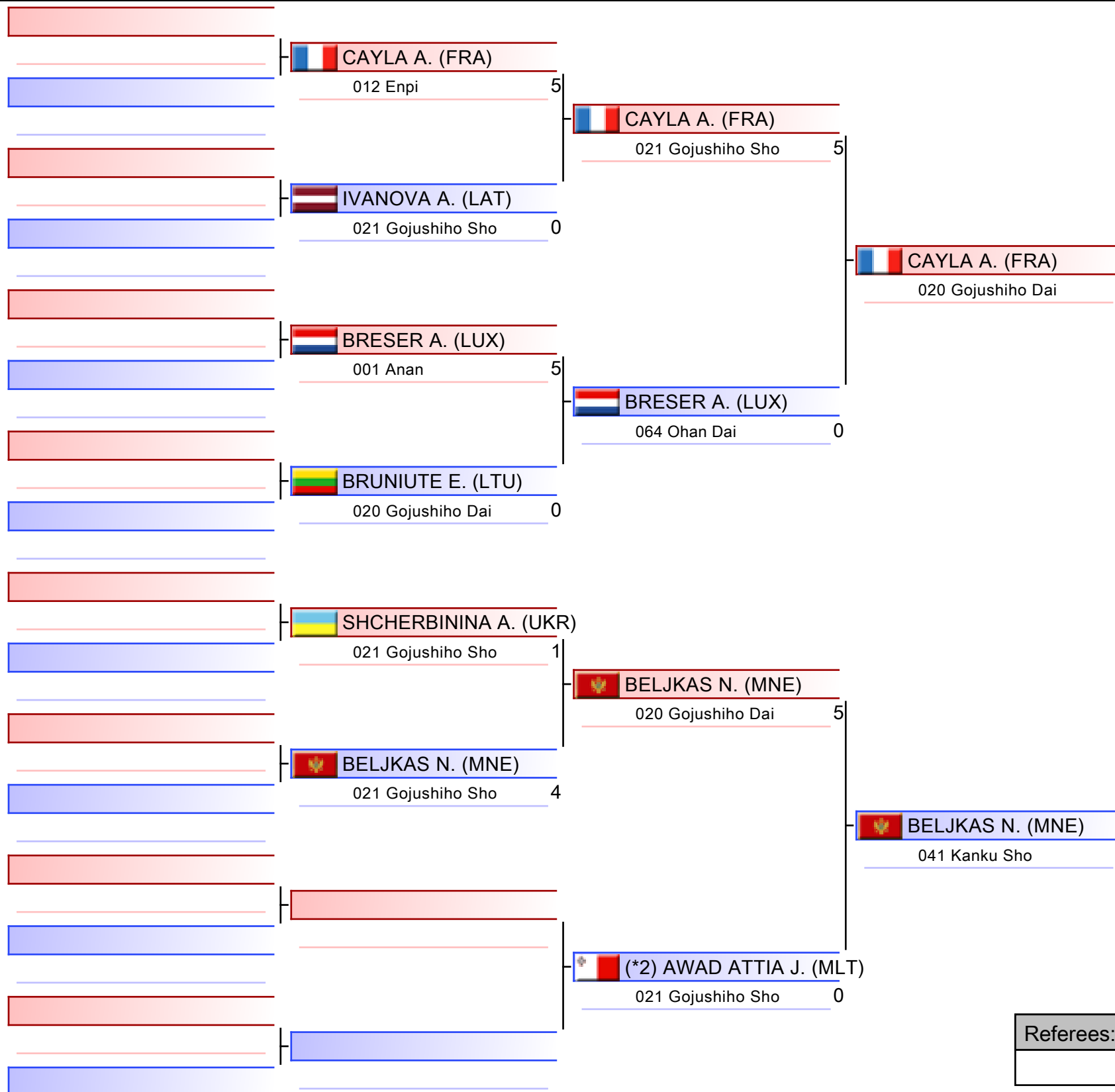

BELJKAS N. (MNE)

1. PENA GARCIA CANDELA (ESP)
2. BELJKAS NEDA (MNE)
3. GOETHE MARIEL (GER)
3. BRANDAUER CHIARA (POR)
5. BENKO SZONJA LOLA (HUN)
5. AWAD ATTIA JENNA (MLT)
7. KISSKOVA KAROLINA (SVK)
7. CAYLA ANAIS (FRA)

*Seeded

Referees:			

Cadet Kata Female

EKF Junior, Cadet & U21 Championships 2026 - Limassol, Spyros Kyprianou Athletic Center, Limassol, CYP

2026-02-06

Tatami
3 09:00

Pool
3/4



WKF
EUROPE

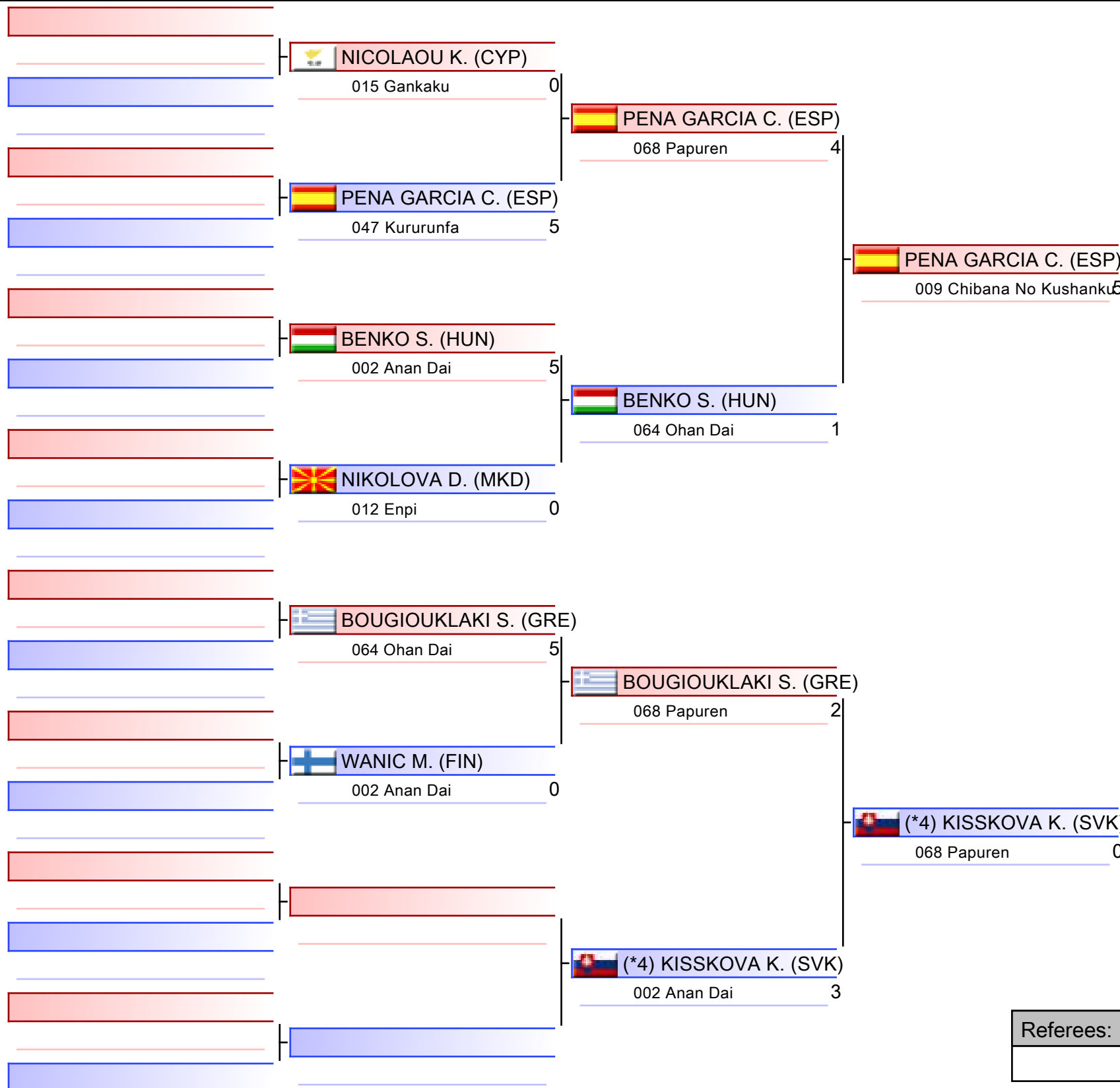

PENA GARCIA C. (ESP)

1. PENA GARCIA CANDELA (ESP)
2. BELJKAS NEDA (MNE)
3. GOETHE MARIEL (GER)
3. BRANDAUER CHIARA (POR)
5. BENKO SZONJA LOLA (HUN)
5. AWAD ATTIA JENNA (MLT)
7. KISSKOVA KAROLINA (SVK)
7. CAYLA ANAIS (FRA)

*Seeded

Referees:			

Cadet Kata Female

EKF Junior, Cadet & U21 Championships 2026 - Limassol, Spyros Kyprianou Athletic Center, Limassol, CYP

2026-02-06

Tatami
4 09:00

Pool
4/4



WKF
EUROPE

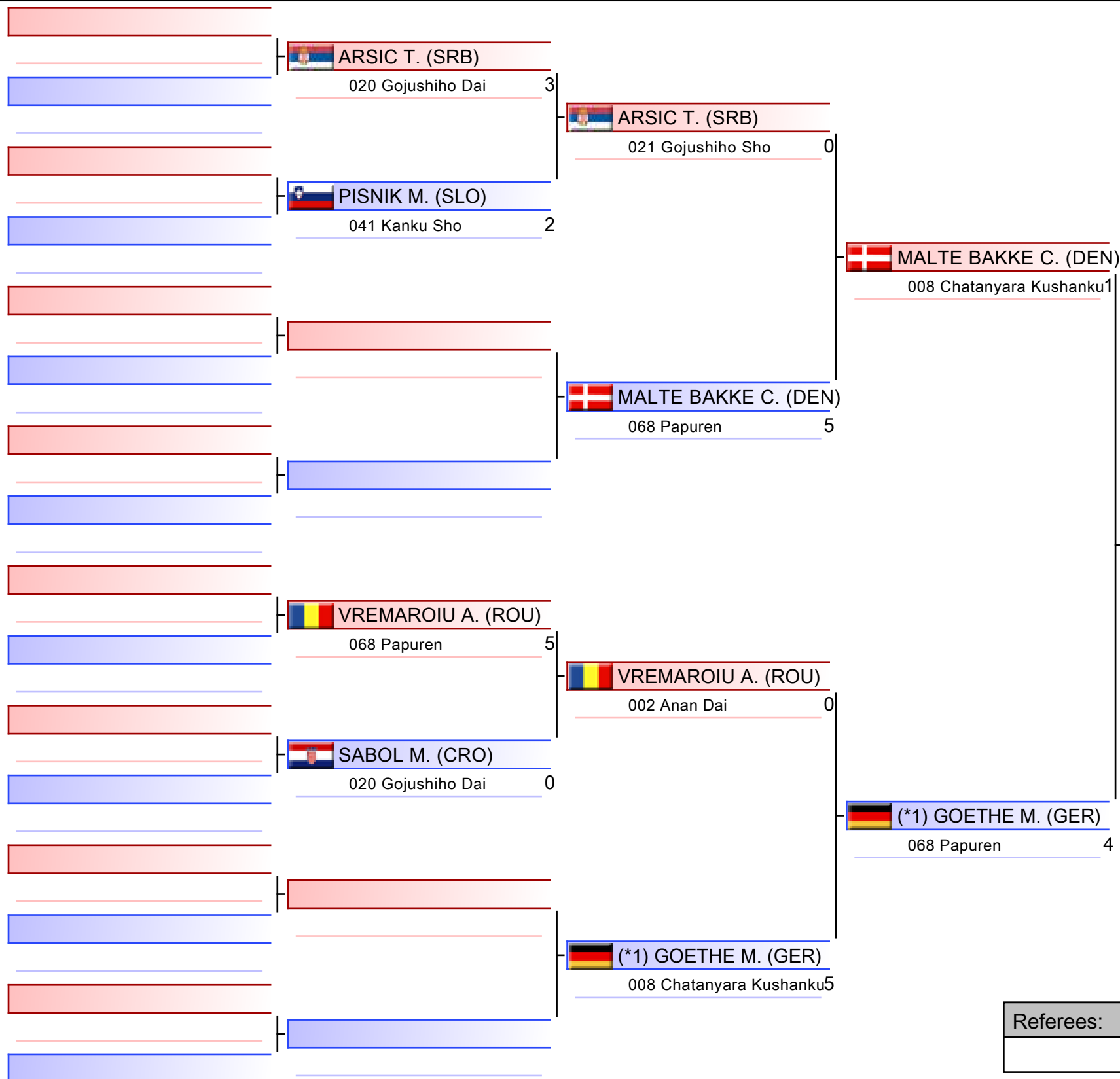

(*1) GOETHE M. (GER)

1. PENA GARCIA CANDELA (ESP)
2. BELJKAS NEDA (MNE)
3. GOETHE MARIEL (GER)
3. BRANDAUER CHIARA (POR)
5. BENKO SZONJA LOLA (HUN)
5. AWAD ATTIA JENNA (MLT)
7. KISSKOVA KAROLINA (SVK)
7. CAYLA ANAIS (FRA)

*Seeded

Referees:			

Pool winner-Cadet Kata Female

EKF Junior, Cadet & U21 Championships 2026 - Limassol, Spyros Kyprianou Athletic Center, Limsassol, CYP

2026-02-06

Tatami
1 09:50

Pool
1/1



WKF
EUROPE

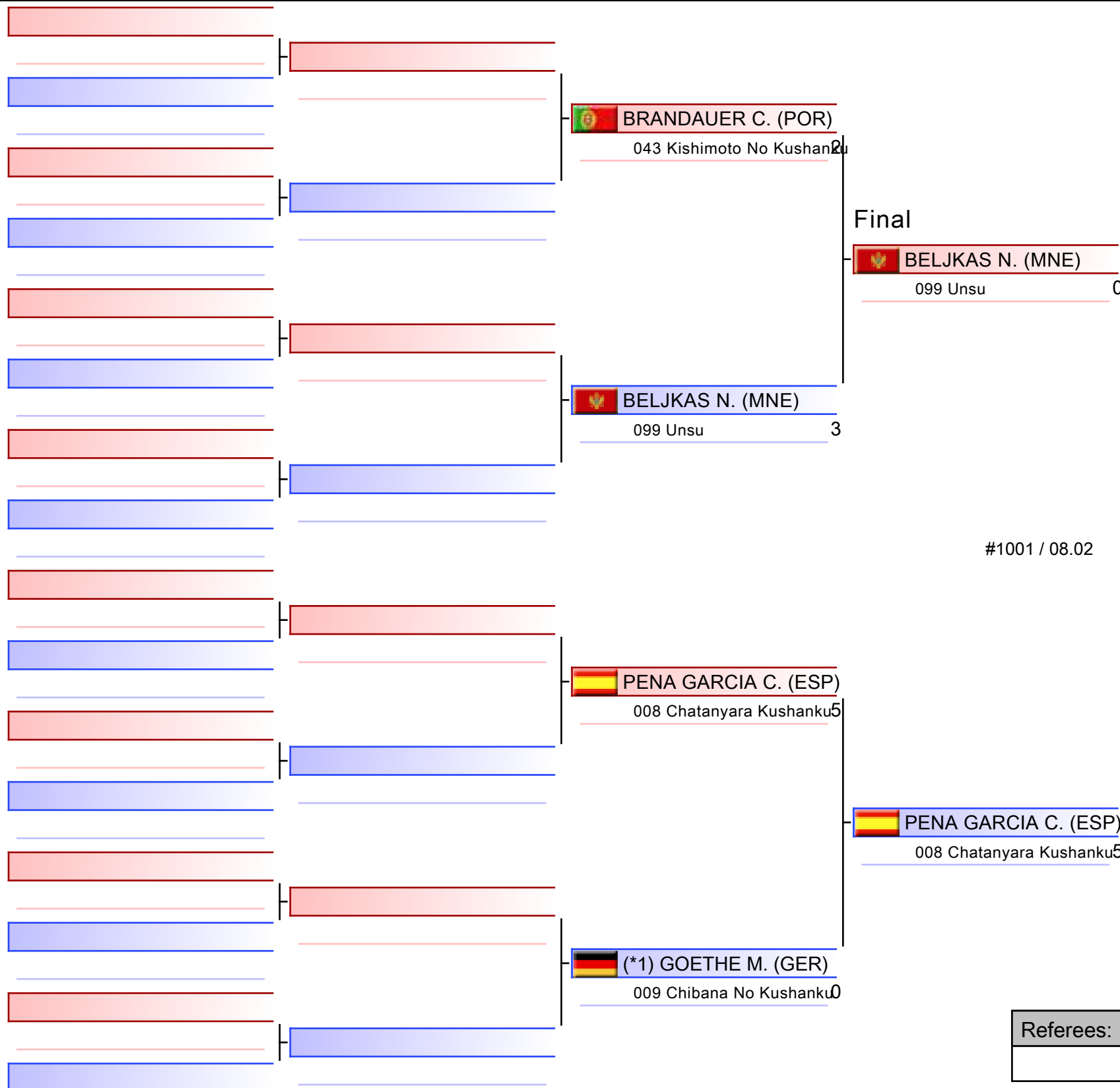

1. PENA GARCIA CANDELA (ESP)
2. BELJKAS NEDA (MNE)
3. GOETHE MARIEL (GER)
3. BRANDAUER CHIARA (POR)
5. BENKO SZONJA LOLA (HUN)
5. AWAD ATTIA JENNA (MLT)
7. KISSKOVA KAROLINA (SVK)
7. CAYLA ANAIS (FRA)

*Seeded

Referees:			

Cadet Kata Female

EKF Junior, Cadet & U21 Championships 2026 - Limassol

2026-02-06

Tatami
1 12:15

Pool
1,2,3,4

(c)sportdata GmbH & Co KG 2000-2026 (2026-02-08 17:46) v 11.0.0 build 2 (2025-01-21 11:49 CET) License: SDIL TWG2025 (expire 2026-09-30)

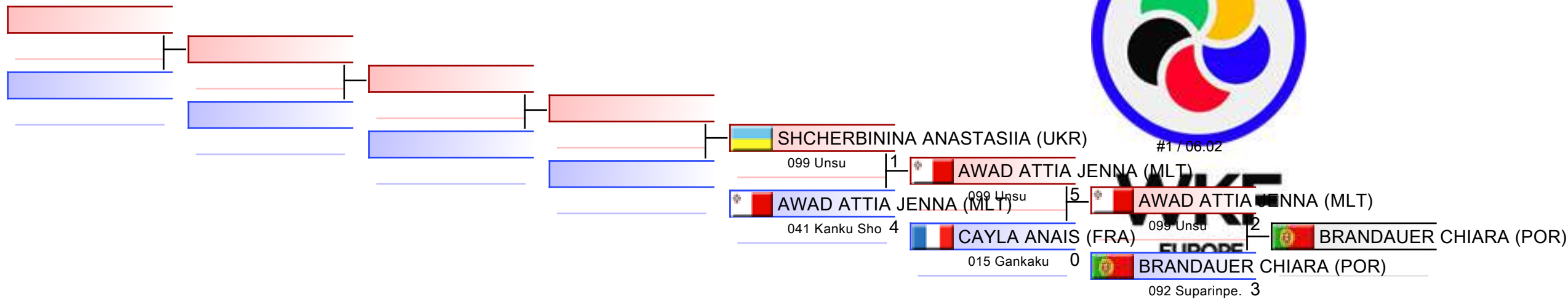

REPECHAGE: (1,2,3,4)

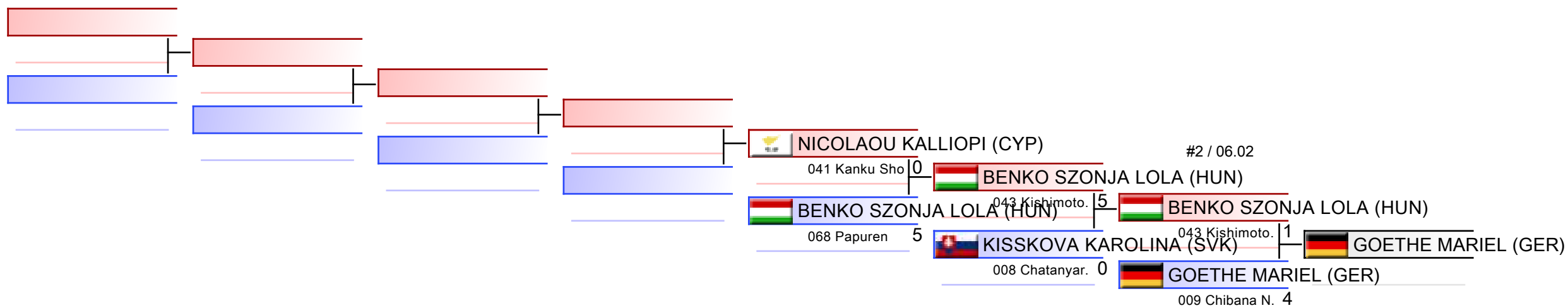

Referees:							
-----------	--	--	--	--	--	--	--



EKF Junior, Cadet & U21 Championships
2026 - Limassol - 2026-02-06



Official Results

Cadet Kata Female			
1	PENA GARCIA CANDELA		ESP - SPAIN
2	BELJKAS NEDA		MNE - MONTENEGRO
3	GOETHE MARIEL		GER - GERMANY
3	BRANDAUER CHIARA		POR - PORTUGAL
5	BENKO SZONJA LOLA		HUN - HUNGARY
5	AWAD ATTIA JENNA		MLT - MALTA
7	KISSKOVA KAROLINA		SVK - SLOVAKIA
7	CAYLA ANAIS		FRA - FRANCE
9	NICOLAOU KALLIOPI		CYP - CYPRUS
9	SHCHERBININA ANASTASIIA		UKR - UKRAINE

CADET KATA MALE



EKF Junior, Cadet & U21 Championships 2026 - Lim..



ENTRIES BY WEIGHT CATEGORY

Cadet Kata Male

As of 8 FEB 2026

Code	ID	Gender	Name	Seeding
ARM	ARM003260	M	POGHOSYAN DAVIT	
AUT	AUT02955	M	ZADINA EMIL	
AZE		M	HASHIMZADA MADAKHIL	
BIH	BIH03985	M	KARIC ANIS	
BUL	BUL003090	M	NIKOLOV NIKOLA	
CRO	CRO03418	M	FAIC DAVID	
CYP	CYP003349	M	CHARALAMBOUS ALEXIS	
CZE	CZE02712	M	ILCIK ADAM	
ENG	ENG003602	M	SAI WUN LI JAKE	
ESP	ESP004284	M	GONZALEZ SAEZ HUGO	3
FRA	FRA004317	M	PILLANT METIS	
GER	GER004073	M	LIBIK DANIEL	
GRE	GRE03040	M	LEKAKOS PARIS	
IRL	IRL02946	M	MC CANN CALVIN	1
ISR	ISR02944	M	LOEBEL YALI IDAN	
ITA	ITA005917	M	NARDACCIO MATTEO	
LAT	LAT02715	M	JAUDZEMS GUSTAVS	
LTU	LTU002737	M	LUKOSEVICIUS MATIAS	
MKD	MKD03017	M	GJORGIEV MATTEO	
MNE	MNE02854	M	STEOVIC UROS	
POL	POL06936	M	KOLACKOV LEON	
POR	POR003474	M	VALENTE SALVADOR	
ROU	ROU2438	M	RAZVAN GEORGE FLOREA	2
SCO	SCO002836	M	FRANCE KYLE	
SLO	SLO02835	M	OVNIC TIAN	
SRB	SRB03721	M	GREB ANDRIJA	
SUI	SUI003341	M	LUETHY CORSIN DION	4
SVK	SVK003399	M	MACKO PETER	
UKR	UKR003683	M	TATARYN NAZAR	
WKF-1	AIN-1006474	M	MIRONOV ALEKSANDR	

Cadet Kata Male

EKF Junior, Cadet & U21 Championships 2026 - Limassol, Spyros Kyprianou Athletic Center, Limassol, CYP

2026-02-06

Tatami
5 09:00

Pool
1/4



WKF
EUROPE

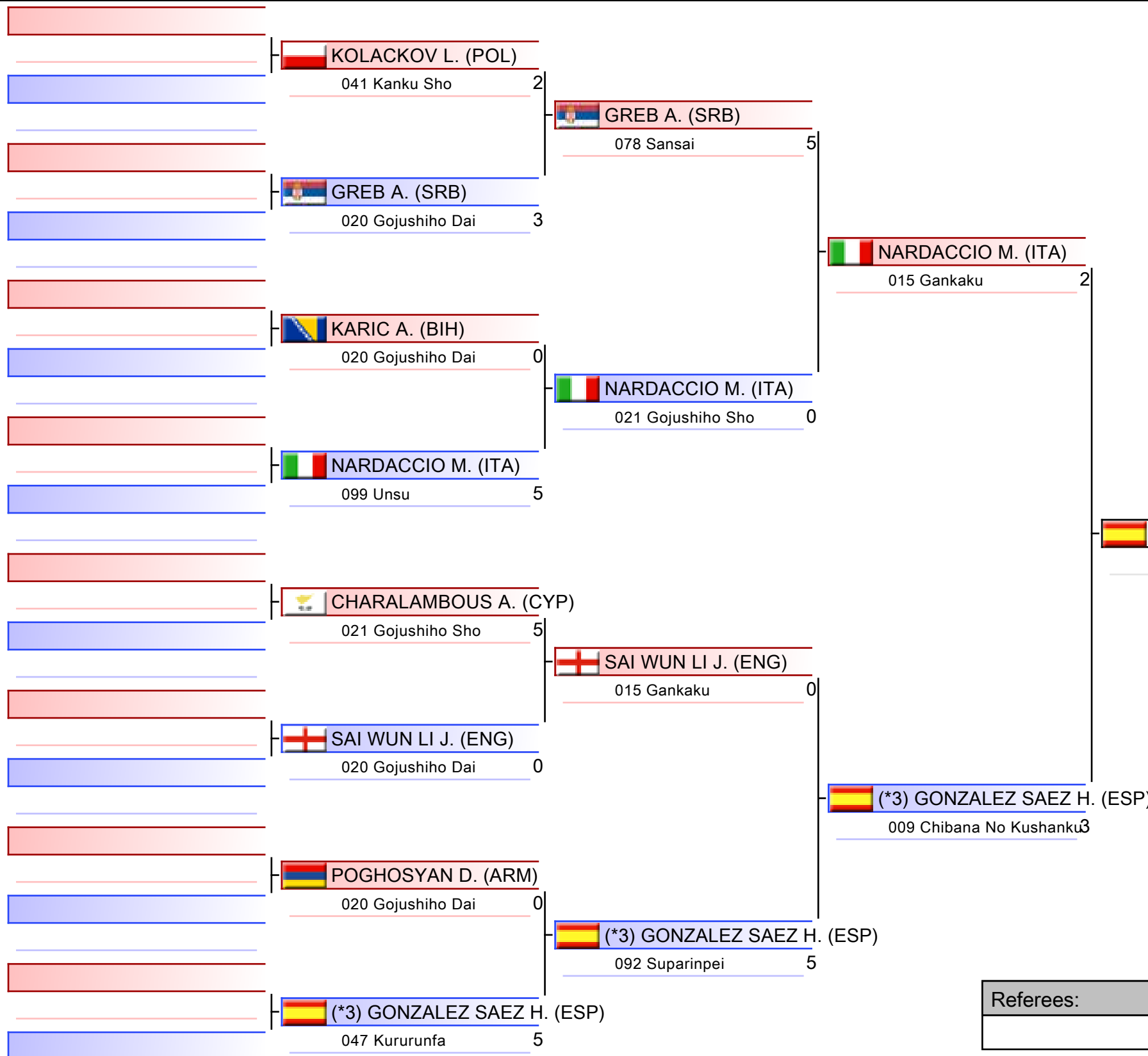

1. RAZVAN GEORGE FLOREA (ROU)
2. VALENTE SALVADOR (POR)
3. GONZALEZ SAEZ HUGO (ESP)
3. FAIC DAVID (CRO)
5. MACKO PETER (SVK)
5. PILLANT METIS (FRA)
7. LOEBEL YALI IDAN (ISR)
7. ILCIK ADAM (CZE)

*Seeded

Referees:			

Cadet Kata Male

EKF Junior, Cadet & U21 Championships 2026 - Limassol, Spyros Kyprianou Athletic Center, Limassol, CYP

2026-02-06

Tatami
6 09:00

Pool
2/4



WKF
EUROPE

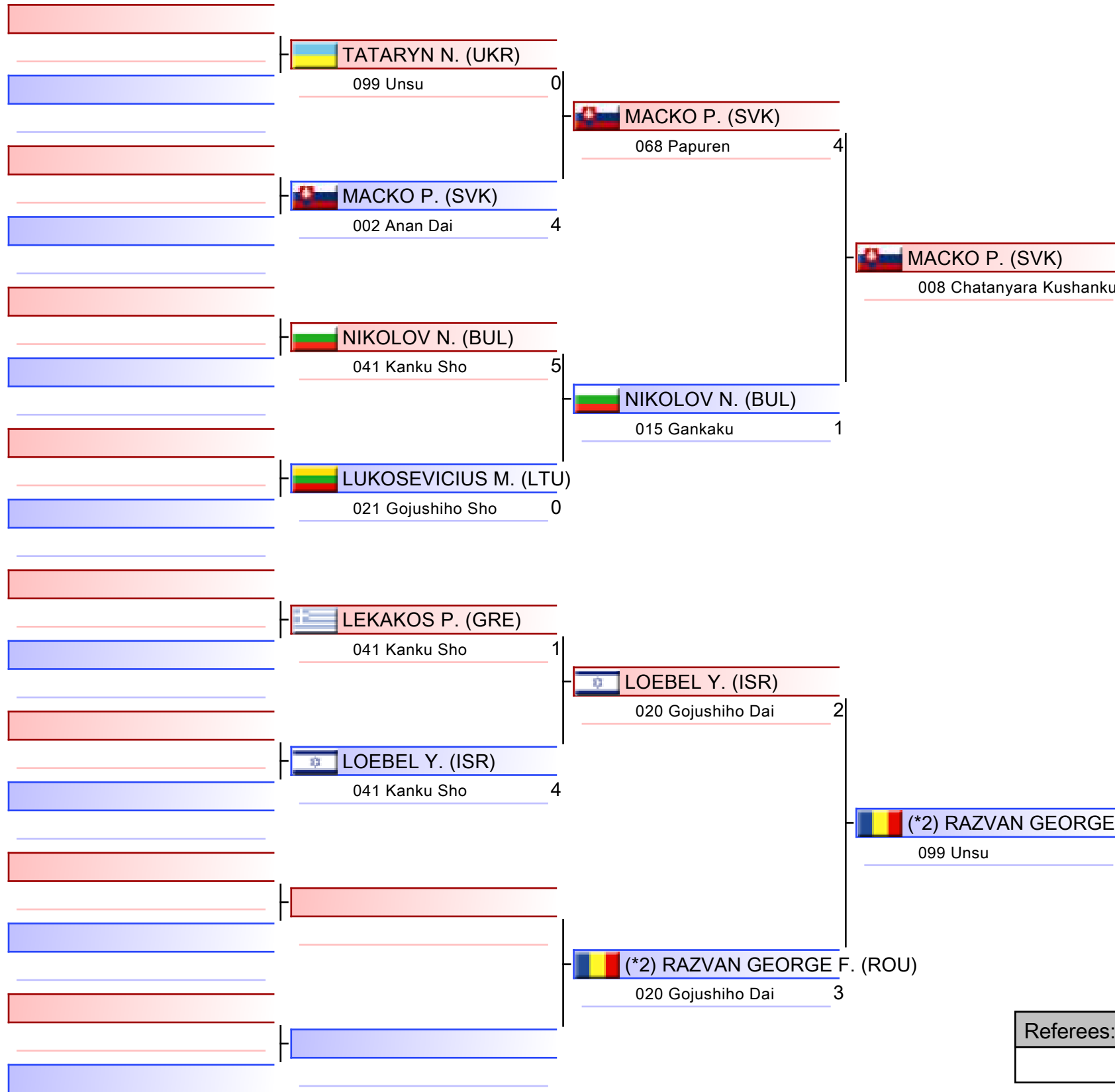

(*) RAZVAN GEORGE F. (ROU)

1. RAZVAN GEORGE FLOREA (ROU)
2. VALENTE SALVADOR (POR)
3. GONZALEZ SAEZ HUGO (ESP)
3. FAIC DAVID (CRO)
5. MACKO PETER (SVK)
5. PILLANT METIS (FRA)
7. LOEBEL YALI IDAN (ISR)
7. ILCIK ADAM (CZE)

*Seeded

Referees:			

Cadet Kata Male

EKF Junior, Cadet & U21 Championships 2026 - Limassol, Spyros Kyprianou Athletic Center, Limassol, CYP

2026-02-06

Tatami
7 09:00

Pool
3/4



WKF
EUROPE

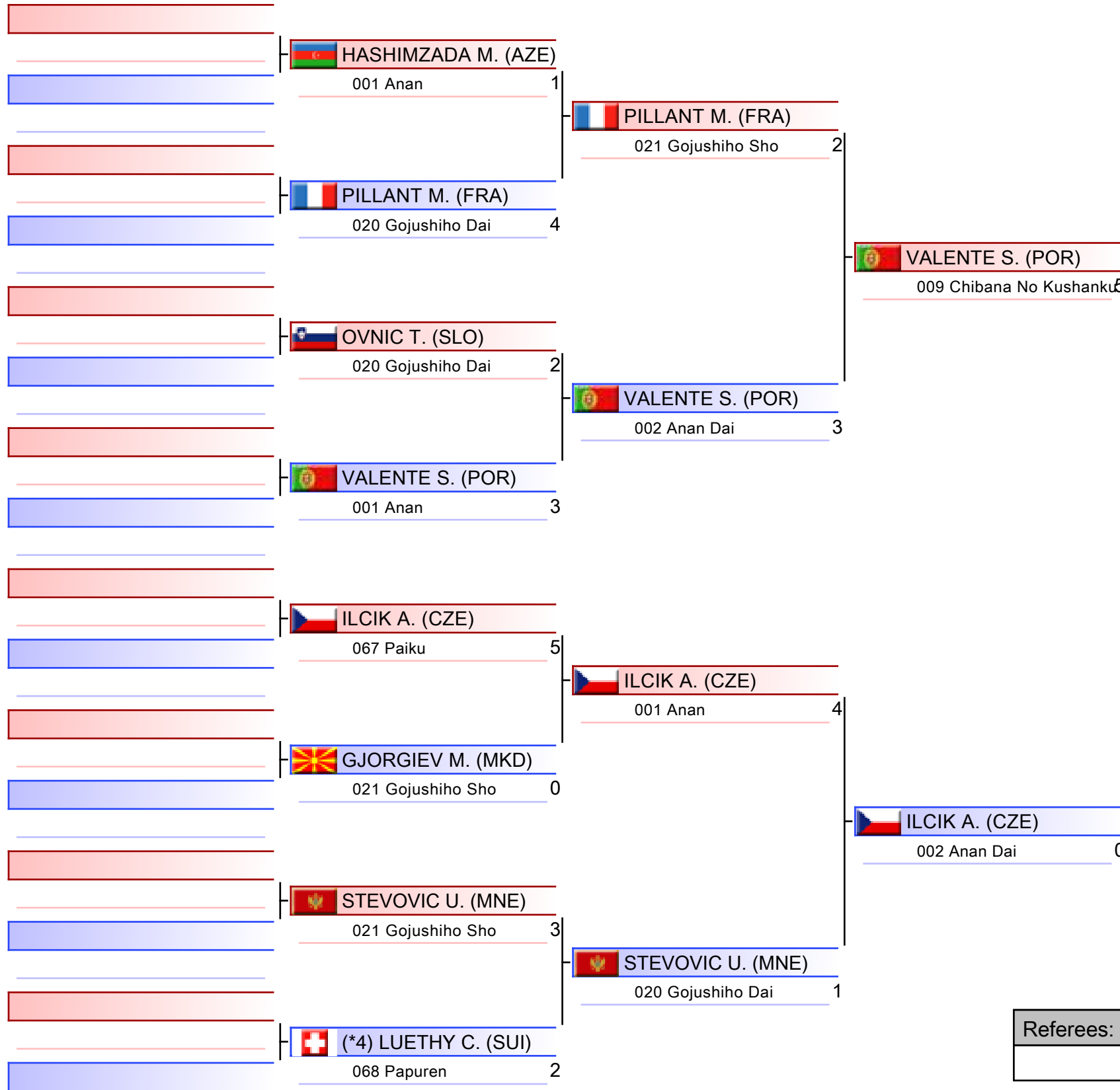

VALENTE S. (POR)

1. RAZVAN GEORGE FLOREA (ROU)
2. VALENTE SALVADOR (POR)
3. GONZALEZ SAEZ HUGO (ESP)
3. FAIC DAVID (CRO)
5. MACKO PETER (SVK)
5. PILLANT METIS (FRA)
7. LOEBEL YALI IDAN (ISR)
7. ILCIK ADAM (CZE)

*Seeded

Referees:			

Cadet Kata Male

EKF Junior, Cadet & U21 Championships 2026 - Limassol, Spyros Kyprianou Athletic Center, Limassol, CYP

2026-02-06

Tatami
8 09:00

Pool
4/4



WKF
EUROPE

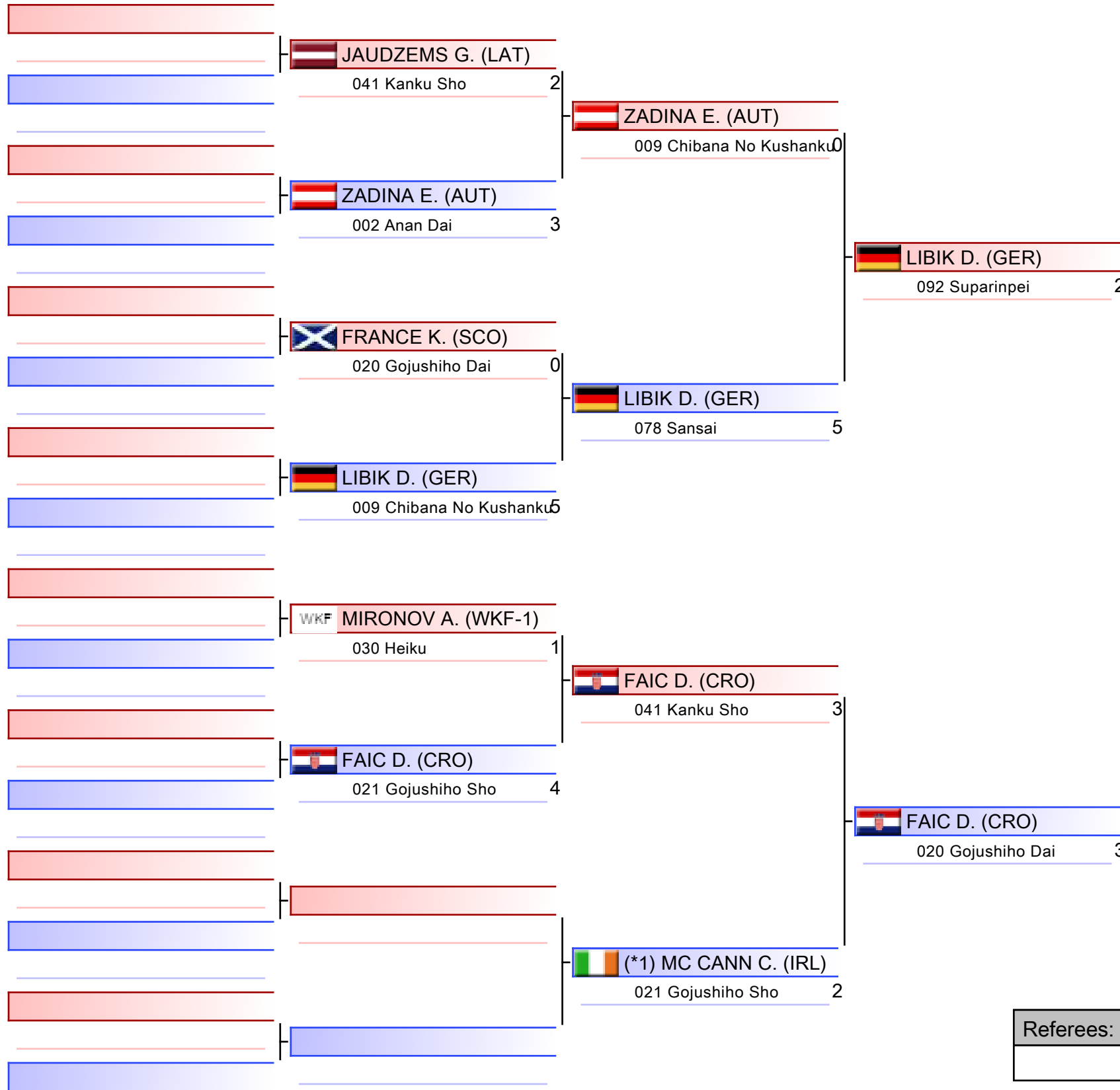

FAIC D. (CRO)

1. RAZVAN GEORGE FLOREA (ROU)
2. VALENTE SALVADOR (POR)
3. GONZALEZ SAEZ HUGO (ESP)
3. FAIC DAVID (CRO)
5. MACKO PETER (SVK)
5. PILLANT METIS (FRA)
7. LOEBEL YALI IDAN (ISR)
7. ILCIK ADAM (CZE)

*Seeded

Referees:			

Pool winner-Cadet Kata Male

EKF Junior, Cadet & U21 Championships 2026 - Limassol, Spyros Kyprianou Athletic Center, Limsassol, CYP

2026-02-06

Tatami
5 09:55

Pool
1/1

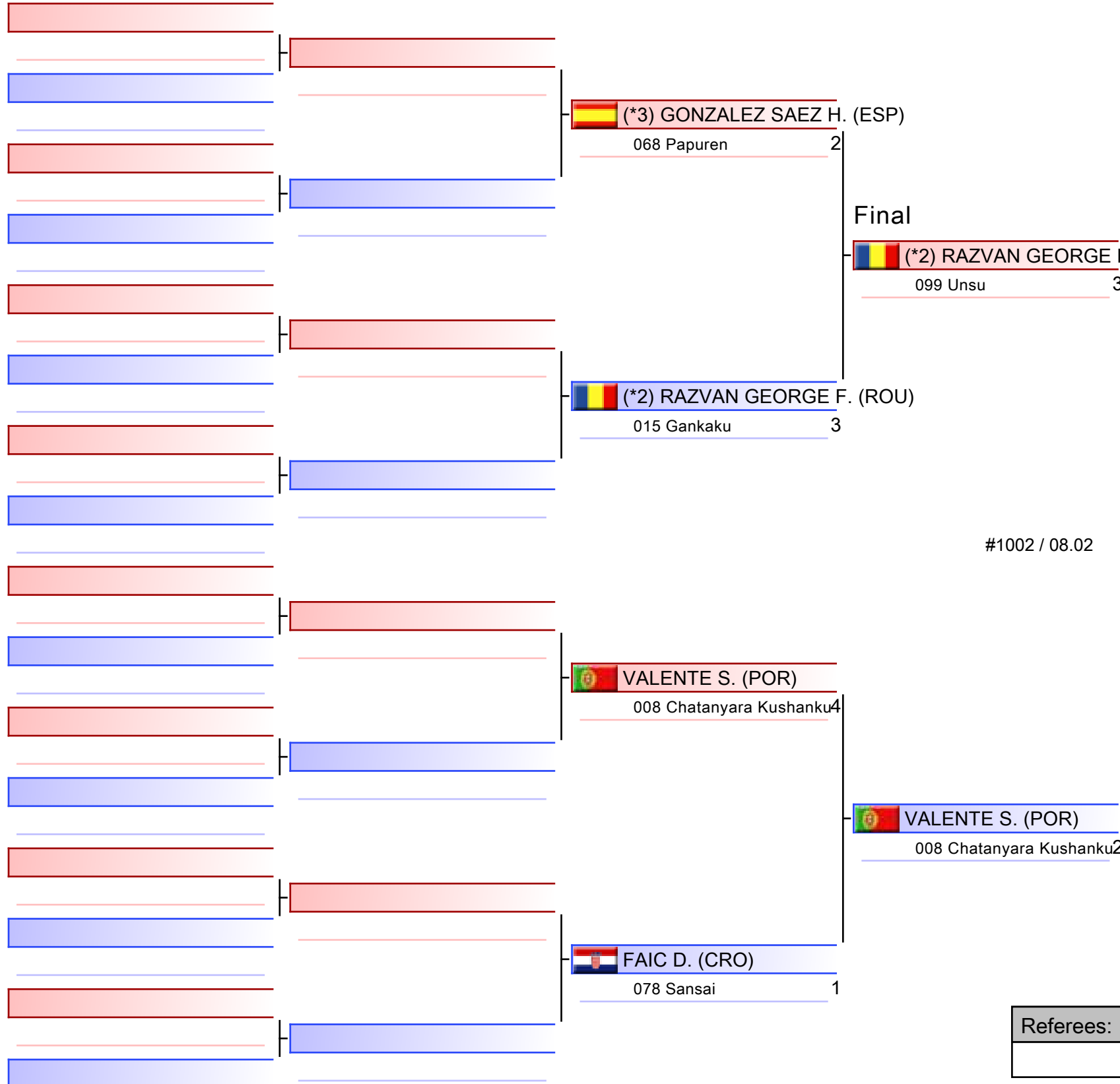

#1002 / 08.02

RAZVAN GEORGE F. (ROU)

1. RAZVAN GEORGE FLOREA (ROU)
2. VALENTE SALVADOR (POR)
3. GONZALEZ SAEZ HUGO (ESP)
3. FAIC DAVID (CRO)
5. MACKO PETER (SVK)
5. PILLANT METIS (FRA)
7. LOEBEL YALI IDAN (ISR)
7. ILCIK ADAM (CZE)

*Seeded

Referees:			

Cadet Kata Male

EKF Junior, Cadet & U21 Championships 2026 - Limassol

2026-02-06

Tatami
2 12:15

Pool
1,2,3,4

(c)sportdata GmbH & Co KG 2000-2026 (2026-02-08 17:46) v 11.0.0 build 2 (2025-01-21 11:49 CET) License: SDIL TWG2025 (expire 2026-09-30)

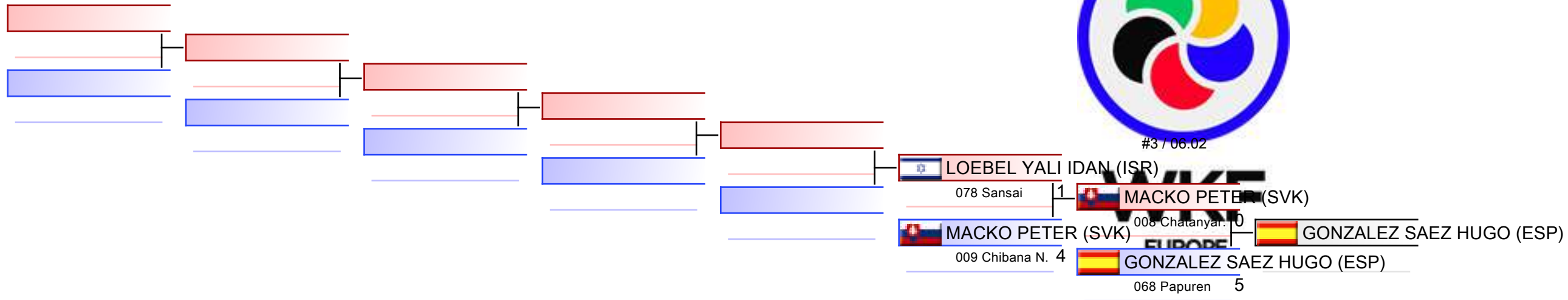

REPECHAGE: (1,2,3,4)

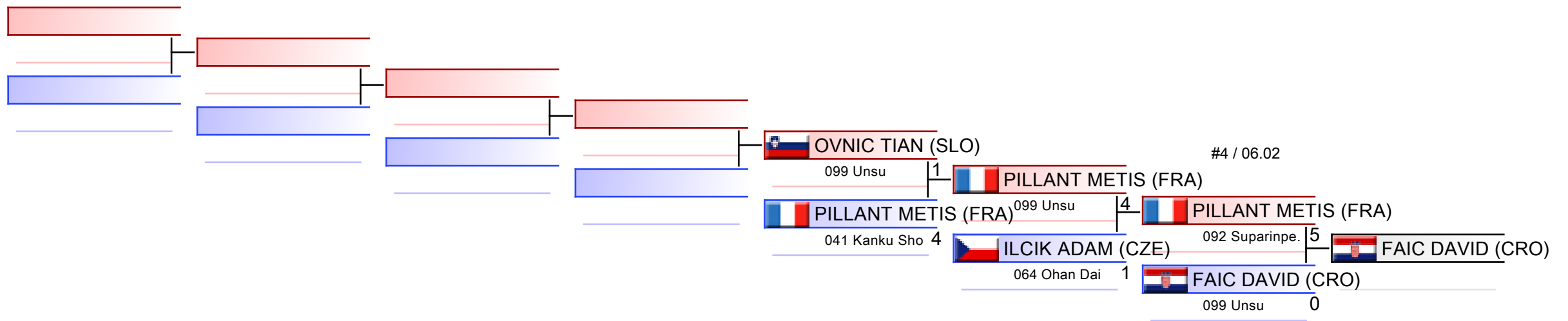

Referees:							
-----------	--	--	--	--	--	--	--



EKF Junior, Cadet & U21 Championships
2026 - Limassol - 2026-02-06



Official Results

Cadet Kata Male			
1	RAZVAN GEORGE FLOREA		ROU - ROMANIA
2	VALENTE SALVADOR		POR - PORTUGAL
3	GONZALEZ SAEZ HUGO		ESP - SPAIN
3	FAIC DAVID		CRO - CROATIA
5	MACKO PETER		SVK - SLOVAKIA
5	PILLANT METIS		FRA - FRANCE
7	LOEBEL YALI IDAN		ISR - ISRAEL
7	ILCIK ADAM		CZE - CZECH REPUBLIC
9	OVNIC TIAN		SLO - SLOVENIA

CADET KUMITE FEMALE -47 KG



EKF Junior, Cadet & U21 Championships 2026 - Lim..



ENTRIES BY WEIGHT CATEGORY

Cadet Kumite Female -47 kg

As of 8 FEB 2026

Code	ID	Gender	Name	Seeding
AUT	AUT003393	F	JEJINIC LEA	
AZE	AZE03305	F	SHAHNAZARLI FIDAN	
BIH	BIH03171	F	ARNAUTOVIC ZAHRA	
BUL	BUL003044	F	DINEVA RAYA	
CRO	CRO03447	F	SKITARELIC GABI	
CYP	CYP003357	F	KLEANTHOUS ARETI	
CZE	CZE003148	F	SEVCOVA BARBORA	
ESP	ESP003963	F	GARCIA RUIZ NADIRA	4
FRA	FRA004508	F	CAMINADE MARIANNE	
GEO	GEO002913	F	KAKUTIA SALOME	3
GER	GER003879	F	PODVOREC NIVES	1
GRE	GRE004264	F	POLYKANDRIOTI MARINA	
HUN	HUN003510	F	PETER PANNA	
ISR	ISR003240	F	KIMYAGAROV LIEL	
ITA	ITA005912	F	SERVETTO THEA	
LAT	LAT003154	F	NIKONOVA ARINA	
LTU	LTU002734	F	ZAJANCKAUSKYTE KOTRYNA	
LUX	LUX02650	F	BELABASS ZINEB	
MDA	MDA002527	F	ROIBA MADALINA	
MKD	MKD03256	F	FILIPOVSKA MIHAELA	
MNE	MNE003990	F	DEDAJ MATEA	
NED	NED003350	F	LEPEZ DARLA	
POL	POL06473	F	GARBACIAK GABRIELA	
POR	POR003561	F	CARVALHO ANA	
ROU	ROU03228	F	BALANESCU MARIA	2
SRB	SRB04016	F	MARTAC SOFIJA	
SUI	SUI004454	F	OYMAK ALMINA	
SVK	SVK003451	F	BIROVA EMMA	
SWE	SWE003397	F	ASLAM ZOHA ZAHEER	
UKR	UKR003924	F	MAISTRENKO HANNA	
WAL	WAL002519	F	BURGESS TIANNA	
WKF-1	WKF105903	F	BORISOVA ALEKSANDRA	

Cadet Kumite Female -47 kg

EKF Junior, Cadet & U21 Championships 2026 - Limassol, Spyros Kyprianou Athletic Center, Limassol, CYP

2026-02-06

Tatami
1 13:05

Pool
1/4



WKF
EUROPE

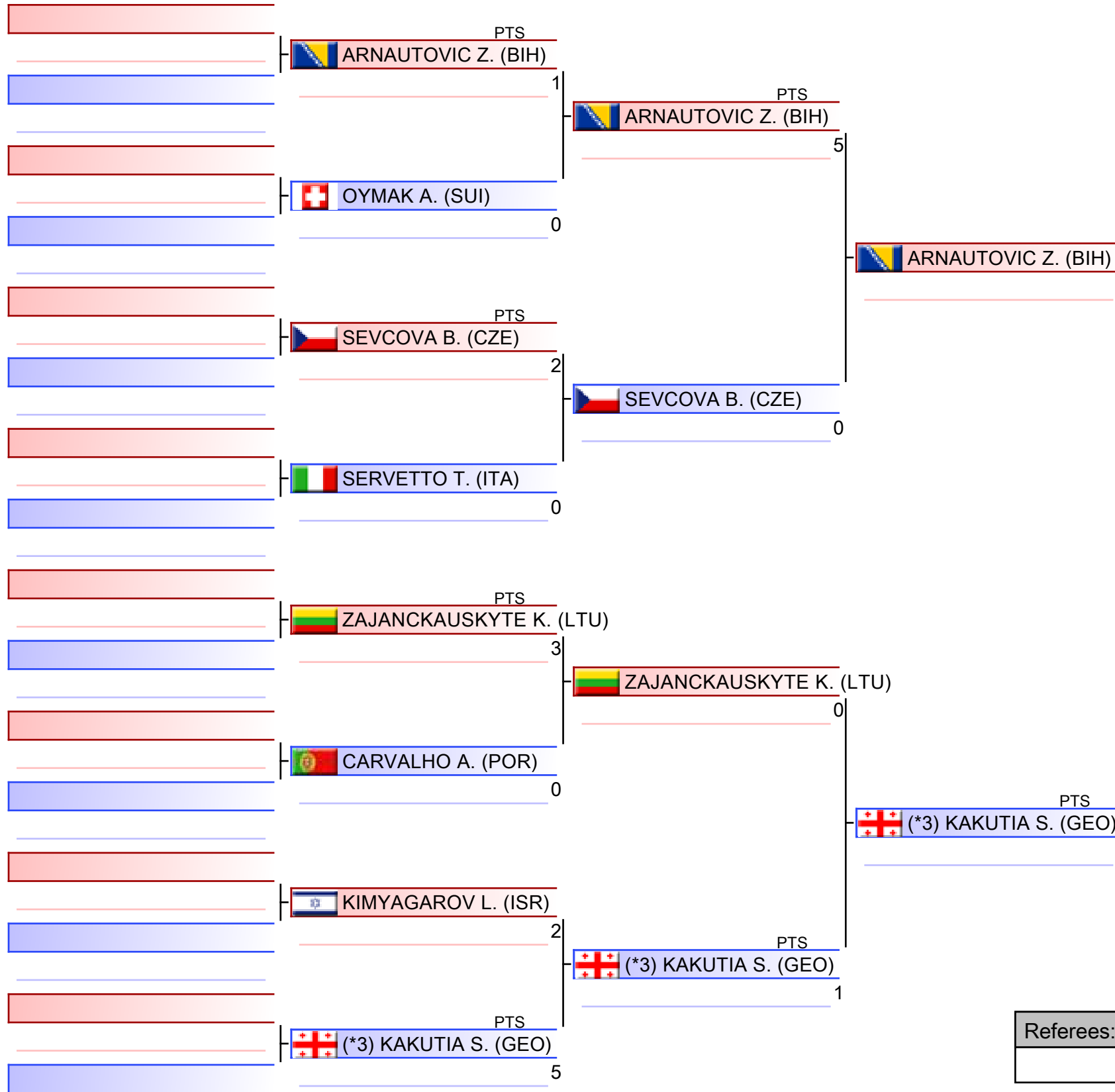

(*3) KAKUTIA S. (GEO)

1. KAKUTIA SALOME (GEO)
2. MAISTRENKO HANNA (UKR)
3. BALANESCU MARIA (ROU)
3. KLEANTHOUS ARETI (CYP)
5. ARNAUTOVIC ZAHRA (BIH)
5. SKITARELIC GABI (CRO)
7. ZAJANCKAUSKYTE KOTRYNA (LTU)
7. PODVOREC NIVES (GER)

*Seeded

Referees:			

Cadet Kumite Female -47 kg

EKF Junior, Cadet & U21 Championships 2026 - Limassol, Spyros Kyprianou Athletic Center, Limassol, CYP

2026-02-06

Tatami
1 13:45

Pool
2/4



WKF
EUROPE

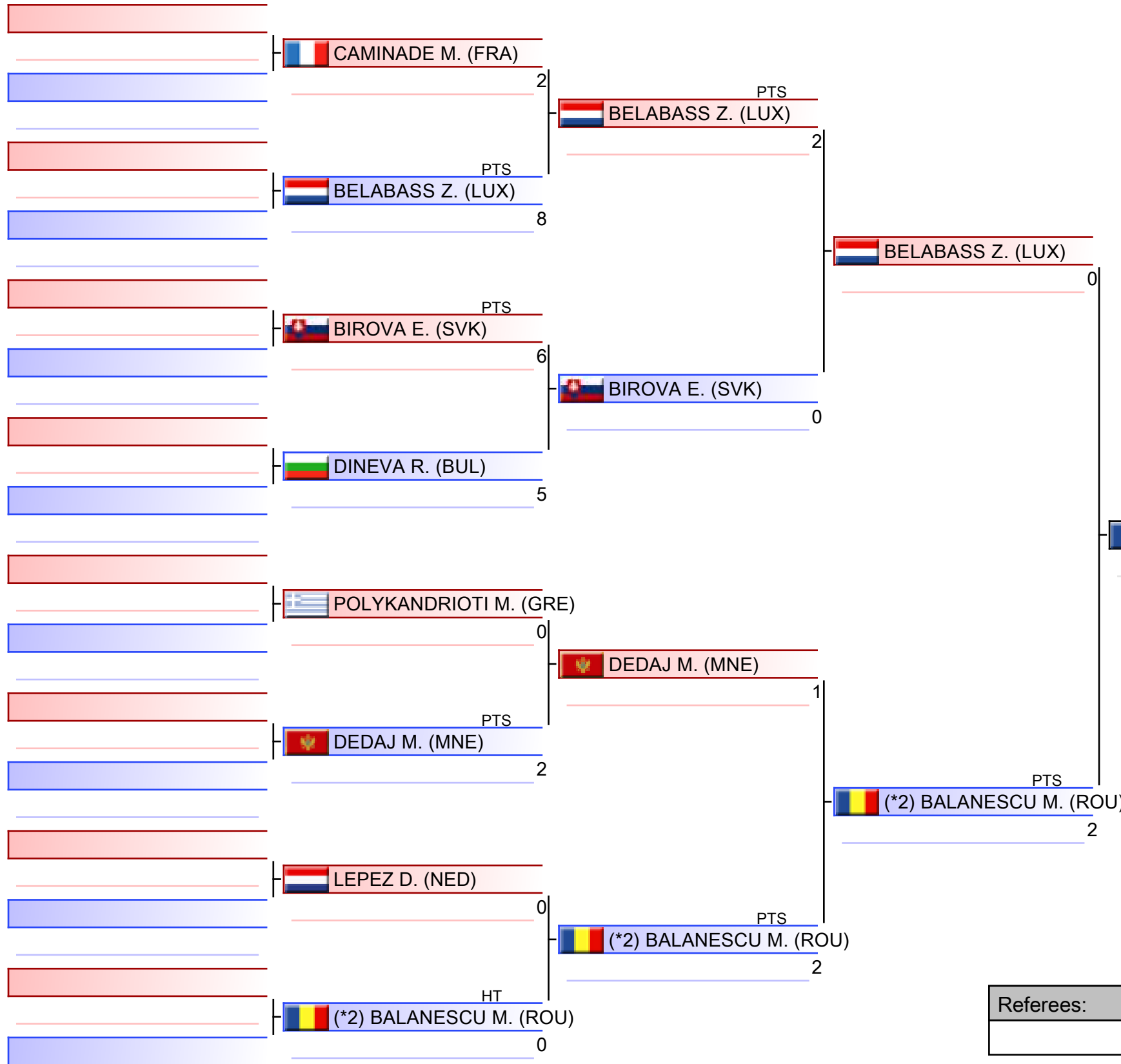

(*2) BALANESCU M. (ROU)

1. KAKUTIA SALOME (GEO)
2. MAISTRENKO HANNA (UKR)
3. BALANESCU MARIA (ROU)
3. KLEANTHOUS ARETI (CYP)
5. ARNAUTOVIC ZAHRA (BIH)
5. SKITARELIC GABI (CRO)
7. ZAJANCKAUSKYTE KOTRYNA (LTU)
7. PODVOREC NIVES (GER)

*Seeded

Referees:			

Cadet Kumite Female -47 kg

EKF Junior, Cadet & U21 Championships 2026 - Limassol, Spyros Kyprianou Athletic Center, Limassol, CYP

2026-02-06

Tatami
2 13:05

Pool
3/4



WKF
EUROPE

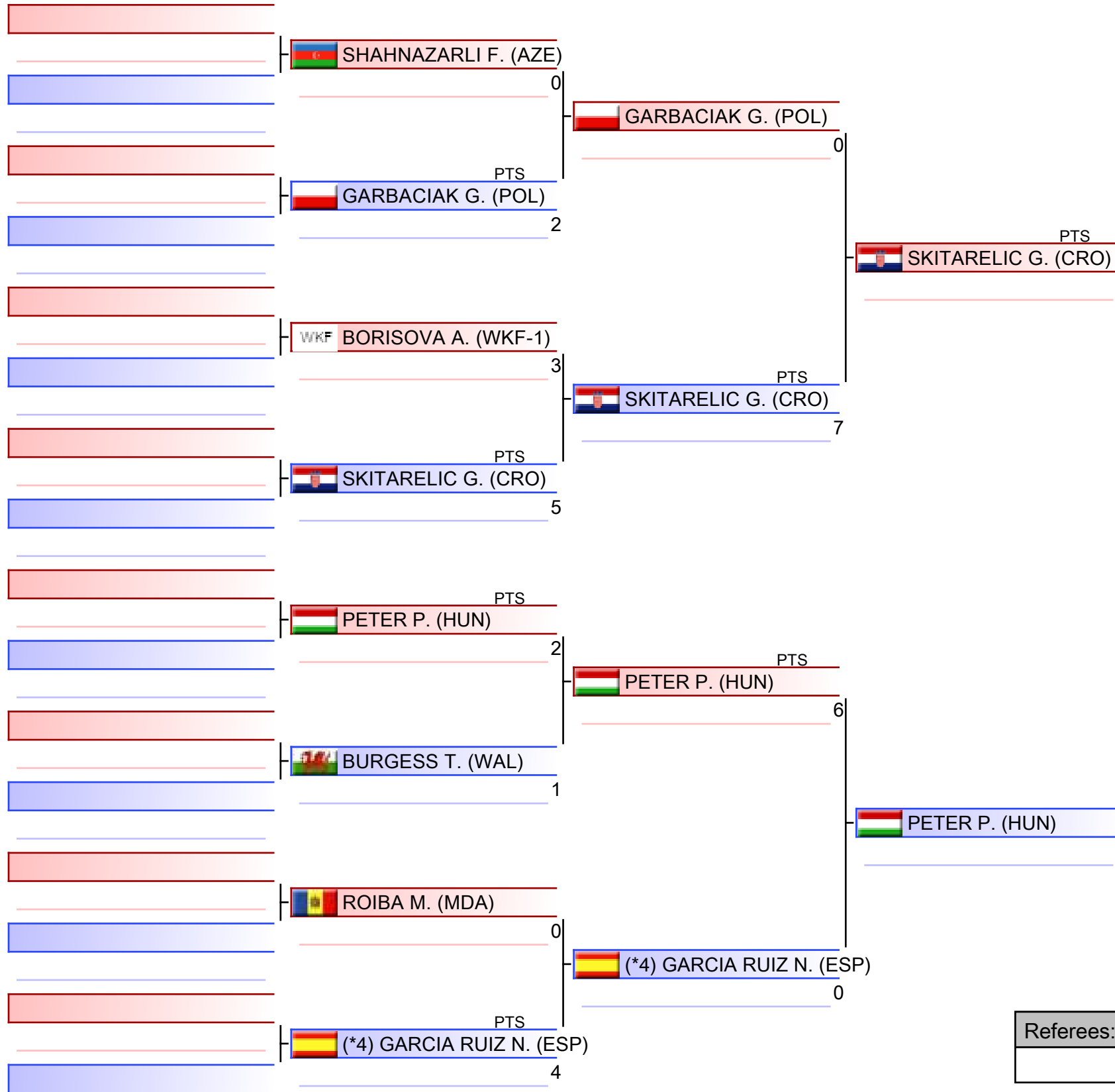

SKITARELIC G. (CRO)

1. KAKUTIA SALOME (GEO)
2. MAISTRENKO HANNA (UKR)
3. BALANESCU MARIA (ROU)
3. KLEANTHOUS ARETI (CYP)
5. ARNAUTOVIC ZAHRA (BIH)
5. SKITARELIC GABI (CRO)
7. ZAJANCKAUSKYTE KOTRYNA (LTU)
7. PODVOREC NIVES (GER)

*Seeded

Referees:			

Cadet Kumite Female -47 kg

EKF Junior, Cadet & U21 Championships 2026 - Limassol, Spyros Kyprianou Athletic Center, Limsassol, CYP

2026-02-06

Tatami
2 13:45

Pool
4/4



WKF
EUROPE

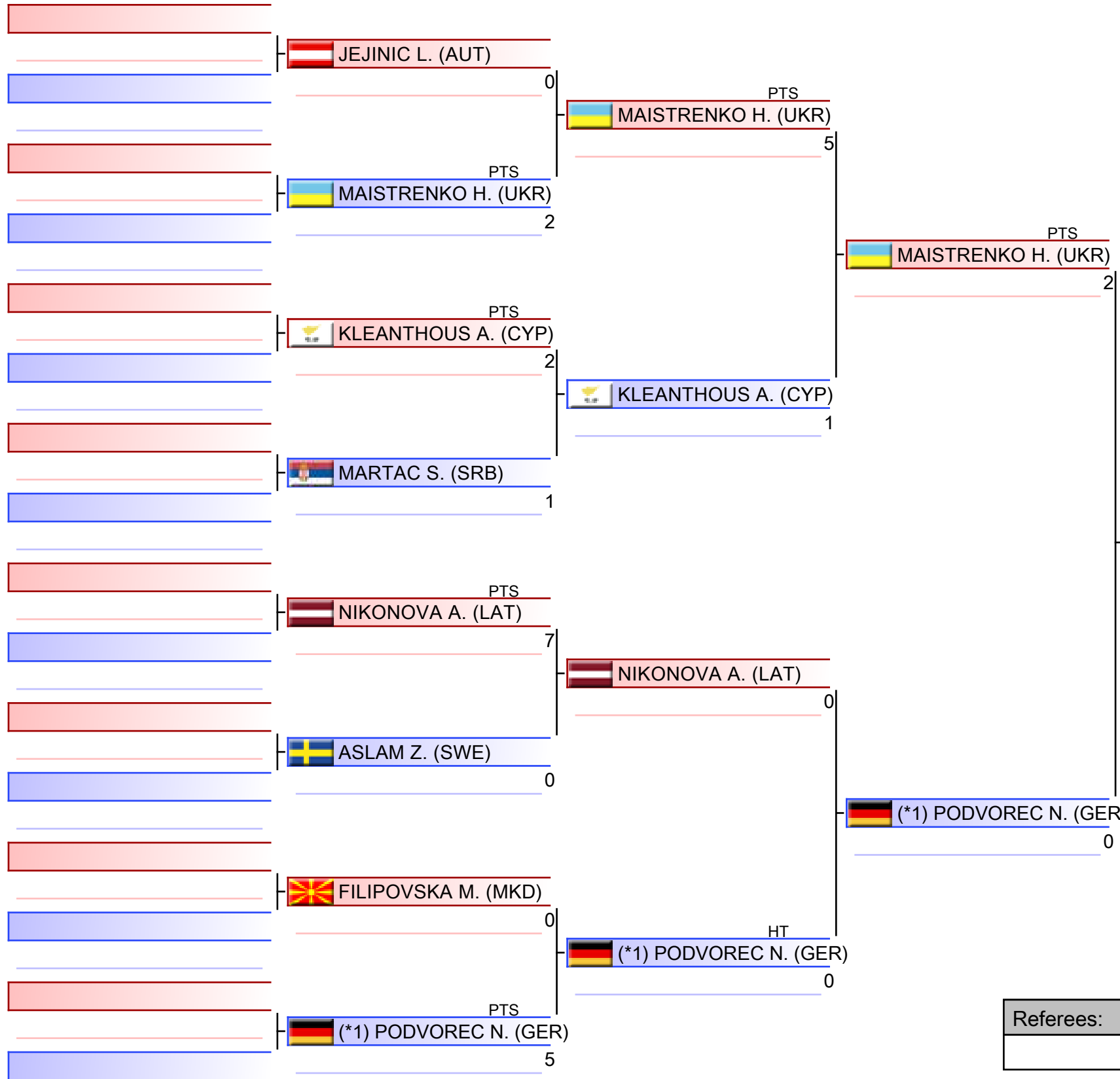

1. KAKUTIA SALOME (GEO)
2. MAISTRENKO HANNA (UKR)
3. BALANESCU MARIA (ROU)
3. KLEANTHOUS ARETI (CYP)
5. ARNAUTOVIC ZAHRA (BIH)
5. SKITARELIC GABI (CRO)
7. ZAJANCKAUSKYTE KOTRYNA (LTU)
7. PODVOREC NIVES (GER)

*Seeded

Referees:			

Pool winner-Cadet Kumite Female -47 kg

EKF Junior, Cadet & U21 Championships 2026 - Limassol, Spyros Kyprianou Athletic Center, Limsassol, CYP

2026-02-06

Tatami
1 14:25

Pool
1/1



WKF
EUROPE

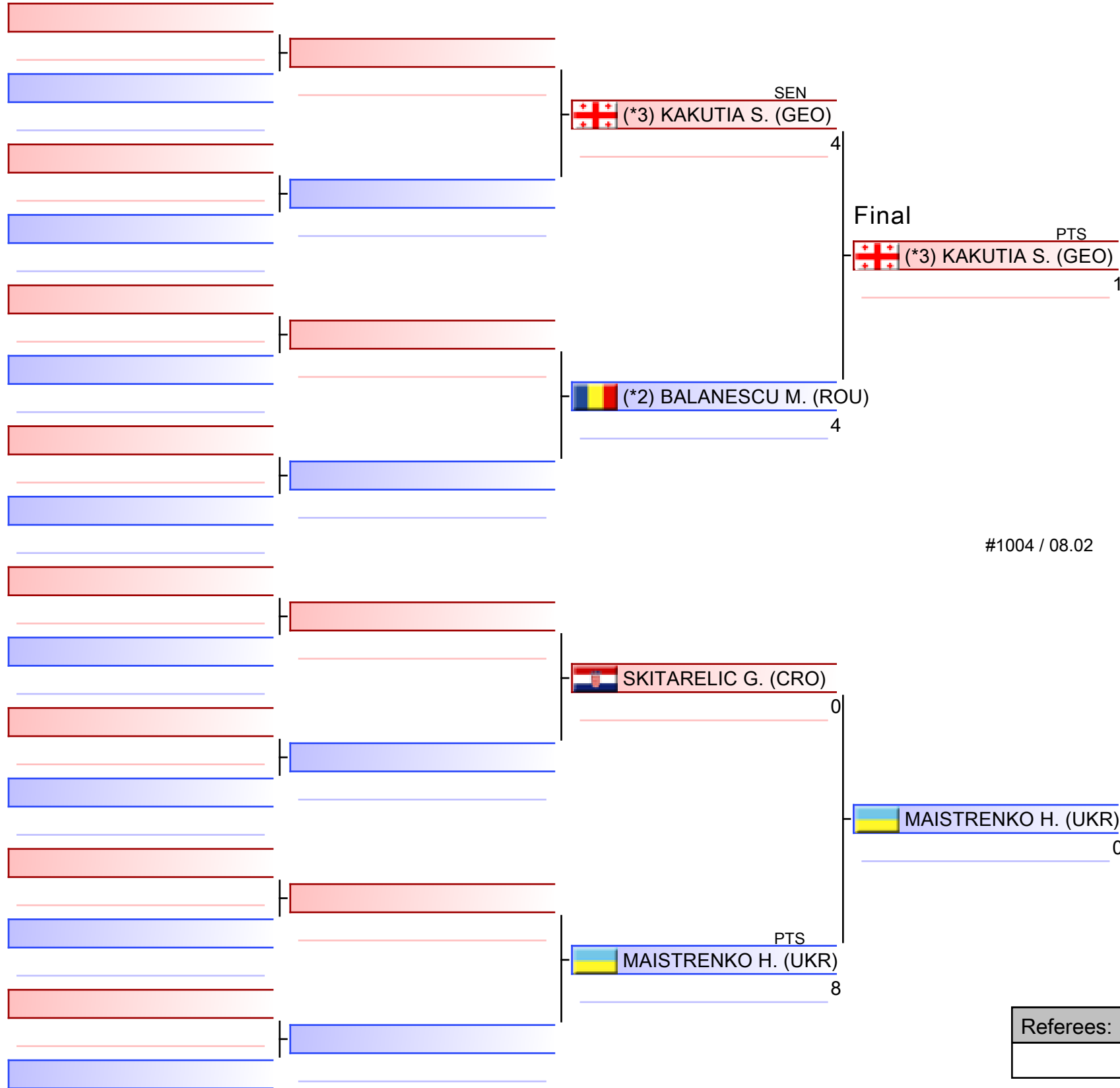

#1004 / 08.02 KAKUTIA S. (GEO)

1. KAKUTIA SALOME (GEO)
2. MAISTRENKO HANNA (UKR)
3. BALANESCU MARIA (ROU)
3. KLEANTHOS ARETI (CYP)
5. ARNAUTOVIC ZAHRA (BIH)
5. SKITARELIC GABI (CRO)
7. ZAJANCKAUSKYTE KOTRYNA (LTU)
7. PODVOREC NIVES (GER)

*Seeded

Referees:			

Cadet Kumite Female -47 kg

EKF Junior, Cadet & U21 Championships 2026 - Limassol

2026-02-06

Tatami
1 16:00

Pool
1,2,3,4

(c)sportdata GmbH & Co KG 2000-2026 (2026-02-08 17:46) v 11.0.0 build 2 (2025-01-21 11:49 CET) License: SDIL TWG2025 (expire 2026-09-30)

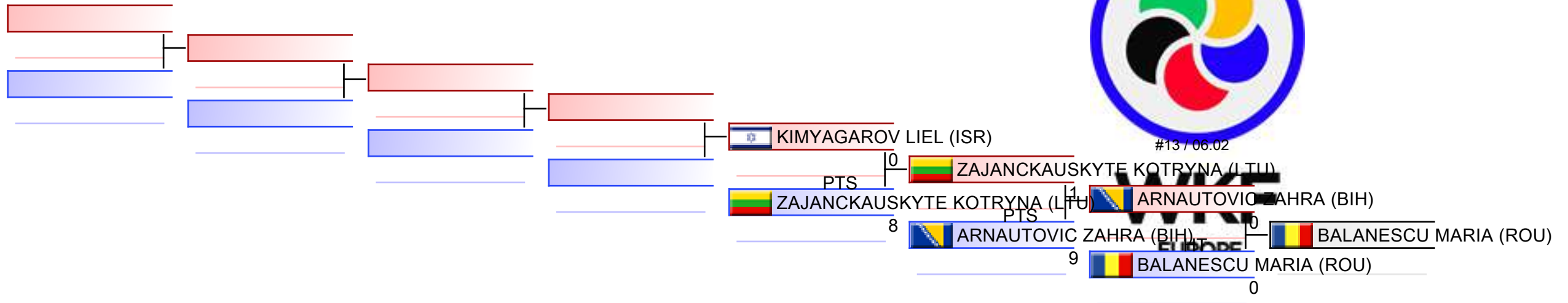

REPECHAGE: (1,2,3,4)

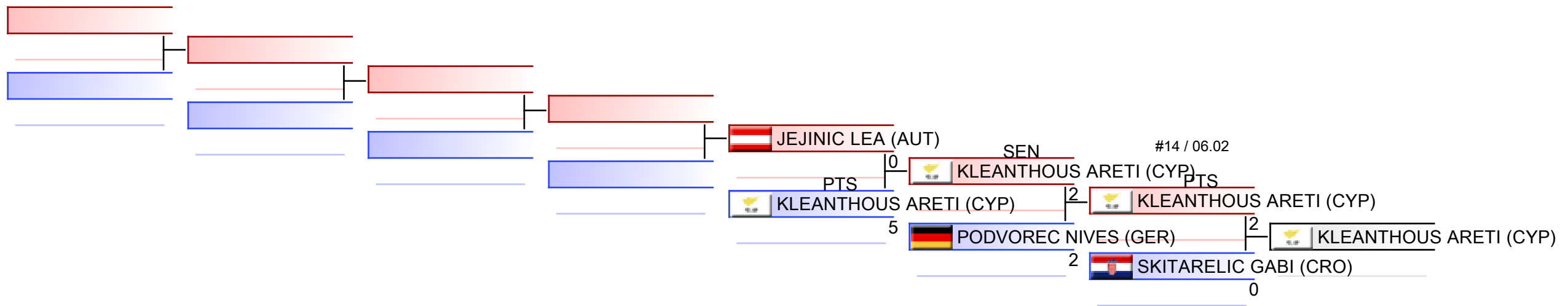

Referees:							
-----------	--	--	--	--	--	--	--



EKF Junior, Cadet & U21 Championships
2026 - Limassol - 2026-02-06



Official Results

Cadet Kumite Female -47 kg			
1	KAKUTIA SALOME		GEO - GEORGIA
2	MAISTRENKO HANNA		UKR - UKRAINE
3	BALANESCU MARIA		ROU - ROMANIA
3	KLEANTHOUS ARETI		CYP - CYPRUS
5	ARNAUTOVIC ZAHRA		BIH - BOSNIA AND HERZEGOVINA
5	SKITARELIC GABI		CRO - CROATIA
7	ZAJANCKAUSKYTE KOTRYNA		LTU - LITHUANIA
7	PODVOREC NIVES		GER - GERMANY
9	KIMYAGAROV LIEL		ISR - ISRAEL
9	JEJINIC LEA		AUT - AUSTRIA

CADET KUMITE FEMALE -54 KG



EKF Junior, Cadet & U21 Championships 2026 - Lim..

ENTRIES BY WEIGHT CATEGORY



Cadet Kumite Female -54 kg

As of 8 FEB 2026

Code	ID	Gender	Name	Seeding
ALB	ALB02389	F	DEDEJ AMANDA	
AUT	AUT02961	F	SOPIC NOEMI	
AZE	AZE03309	F	NAJAFLI DANIZ	
BEL	BEL003217	F	POSKIN EMILIE	2
BIH	BIH005208	F	HADZIC AZRA	
BUL	BUL003010	F	TODOROVA ALBENA	
CRO	CRO03442	F	JELCIC ROZA	
CYP	CYP03112	F	KATSANTONI ZOE	
CZE	CZE003001	F	SVOBODOVA ELISKA	
DEN	DEN003039	F	POULSEN JO KJAER	
ENG	ENG003605	F	URBAN MAJA	
ESP	ESP03601	F	CHICA TOLOSA ARIADNA	
FRA	FRA004498	F	DELORME AMINA	
GER	GER004222	F	ROEDER LUISE	
GRE	GRE02753	F	ANASTASIADI ANASTASIA	4
HUN	HUN003330	F	KUN REGINA KIRA	
IRL	IRL003107	F	OLDREY ELLEN	
ISR	ISR003243	F	RASIUK MATAR	
ITA	ITA005911	F	MARENCO MAYA	
LAT	LAT003161	F	AKOPOVA KATRINA	
LUX	LUX02657	F	INTINI RAFFAELLI LARA	
MDA	MDA02341	F	RADAUTA LOREDANA	
MKD	MKD003436	F	HIRA FIDANI	
MLT	MLT02329	F	MADDEN LEIA-SUMMER	
MNE	MNE02877	F	MARKOVIC PETRA	
NOR	NOR002828	F	OLSENG INGRID	3
POL	POL05545	F	BALUT PATRYCJA	
POR	POR003562	F	MARTINS LIRA	
ROU	ROU03229	F	BALANESCU IOANA	1
SCO	SCO002735	F	CLARK RUBY	
SLO	SLO02695	F	IVANCIC KIARA	
SRB	SRB03388	F	TRIKOS MILICA	
SVK	SVK003245	F	STREICHEROVA ROMANA	
SWE	SWE003353	F	LARSSON ERHARDT SIGNE	
UKR	UKR003920	F	ELII SOFIIA	
WKF-1	WKF-1006805	F	KALOEVA KIRA	

Cadet Kumite Female -54 kg

EKF Junior, Cadet & U21 Championships 2026 - Limassol, Spyros Kyprianou Athletic Center, Limassol, CYP

2026-02-06

Tatami
3 13:05

Pool
1/4

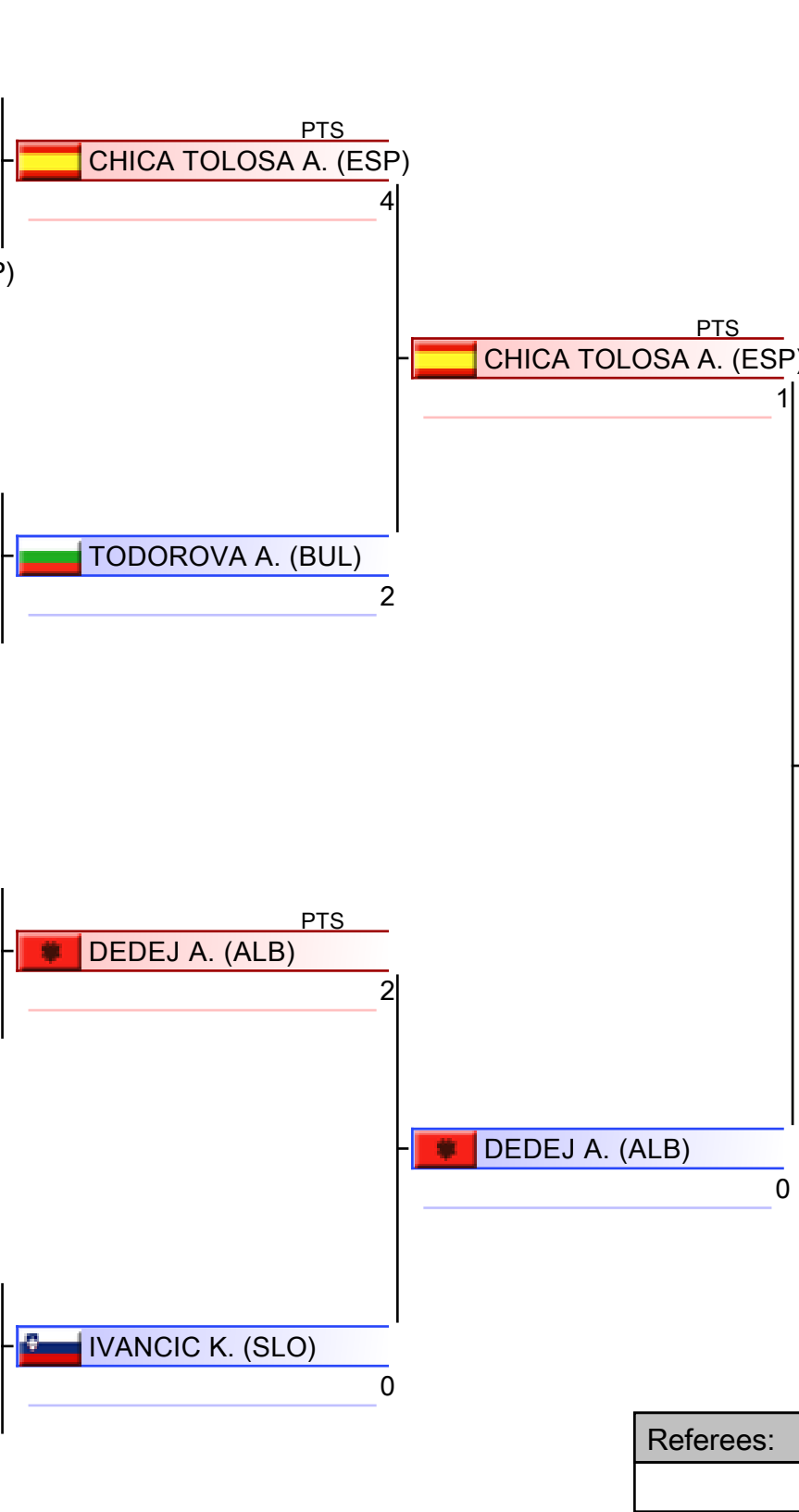
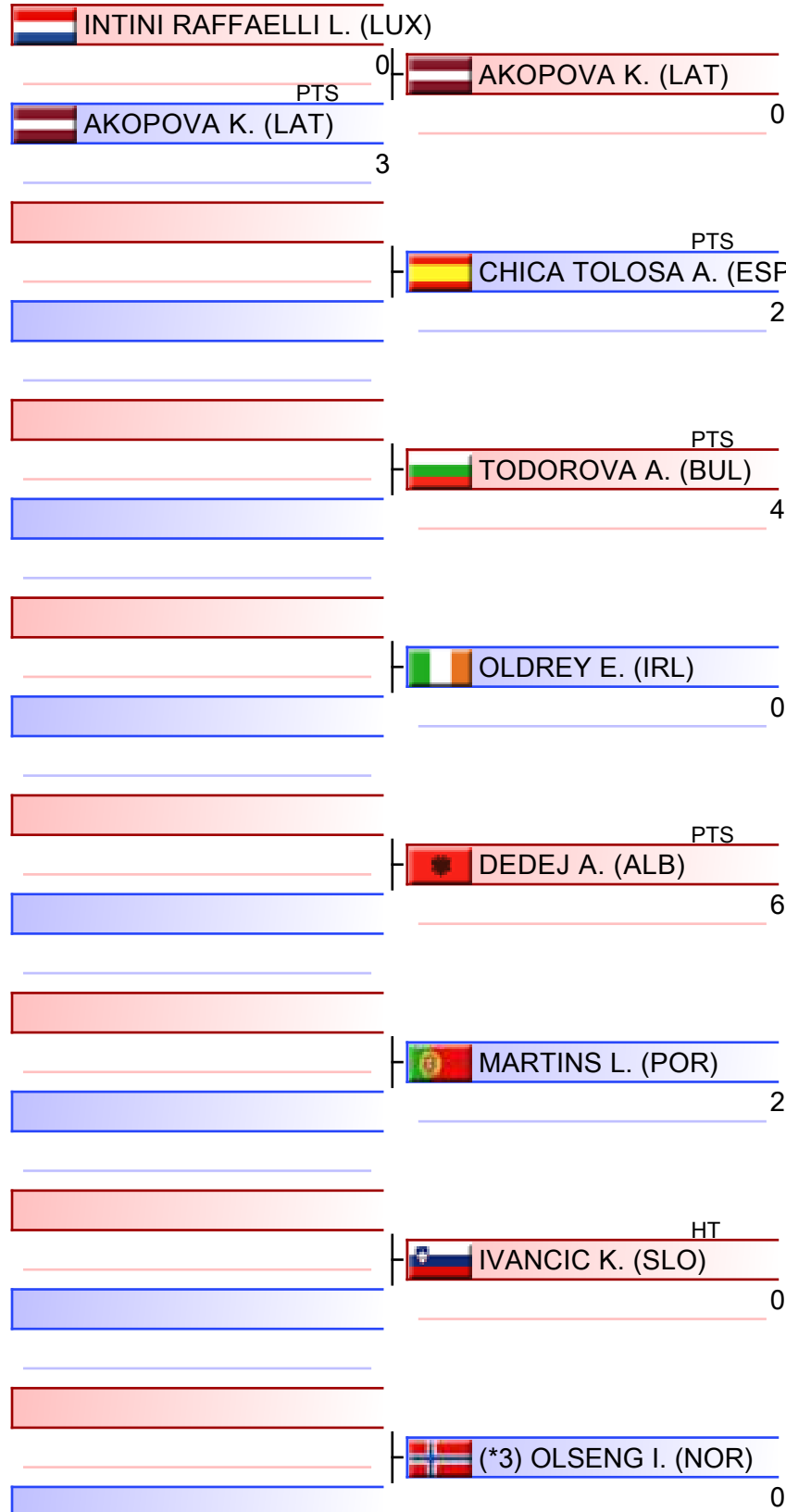

WKF
EUROPE

CHICA TOLOSA A. (ESP)

1. ELII SOFIIA (UKR)
2. KALOEVA KIRA (WKF-1)
3. BALANESCU IOANA (ROU)
3. CHICA TOLOSA ARIADNA (ESP)
5. MARKOVIC PETRA (MNE)
5. POSKIN EMILIE (BEL)
7. RADAUTA LOREDANA (MDA)
7. KUN REGINA KIRA (HUN)

*Seeded

Referees:			

Cadet Kumite Female -54 kg

EKF Junior, Cadet & U21 Championships 2026 - Limassol, Spyros Kyprianou Athletic Center, Limassol, CYP

2026-02-06

Tatami
3 13:50

Pool
2/4

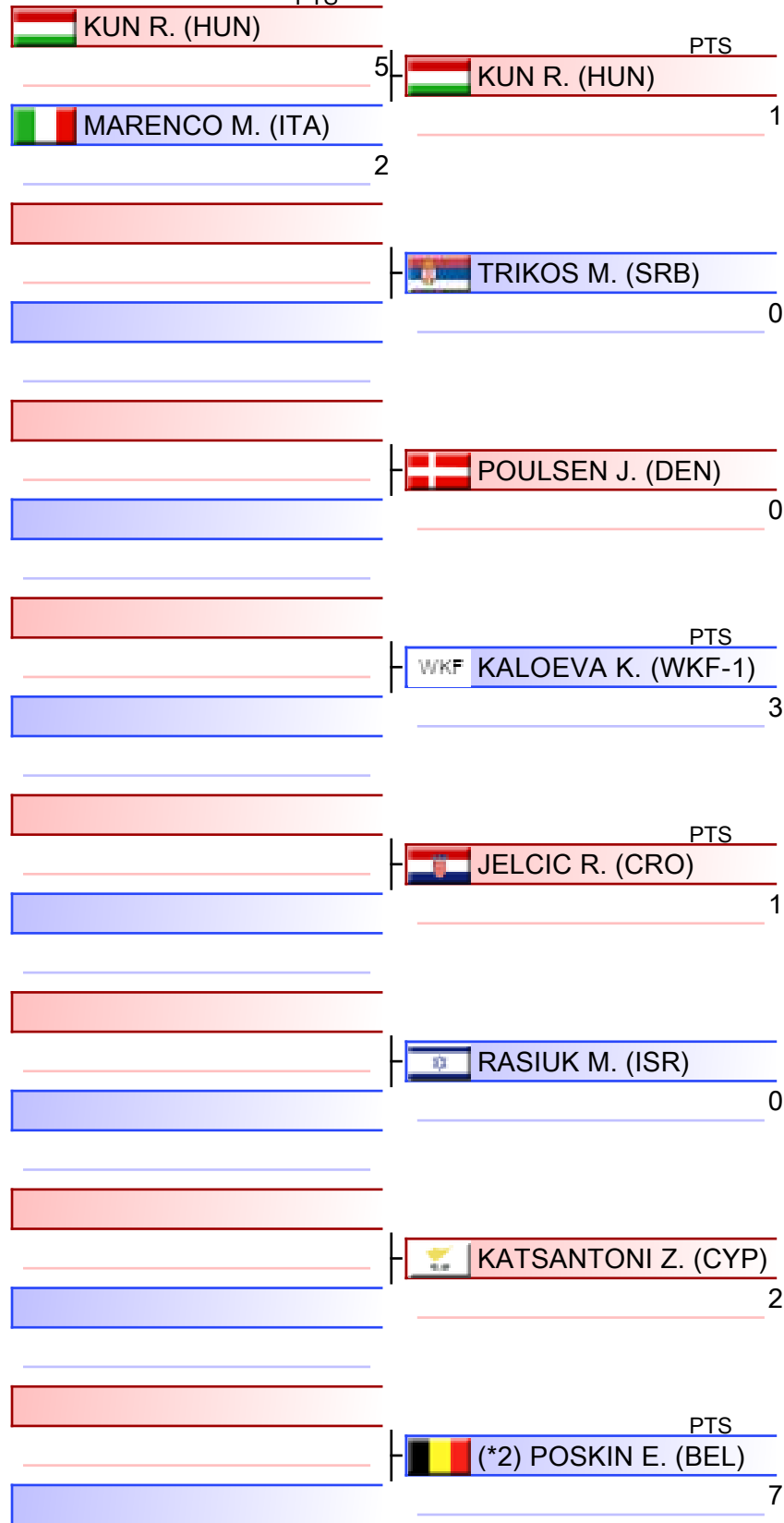

WKF
EUROPE

WKF KALOEVA K. (WKF-1)

1. ELII SOFIIA (UKR)
2. KALOEVA KIRA (WKF-1)
3. BALANESCU IOANA (ROU)
3. CHICA TOLOSA ARIADNA (ESP)
5. MARKOVIC PETRA (MNE)
5. POSKIN EMILIE (BEL)
7. RADAUTA LOREDANA (MDA)
7. KUN REGINA KIRA (HUN)

*Seeded

Referees:			

Cadet Kumite Female -54 kg

EKF Junior, Cadet & U21 Championships 2026 - Limassol, Spyros Kyprianou Athletic Center, Limassol, CYP

2026-02-06

Tatami
4 13:05

Pool
3/4

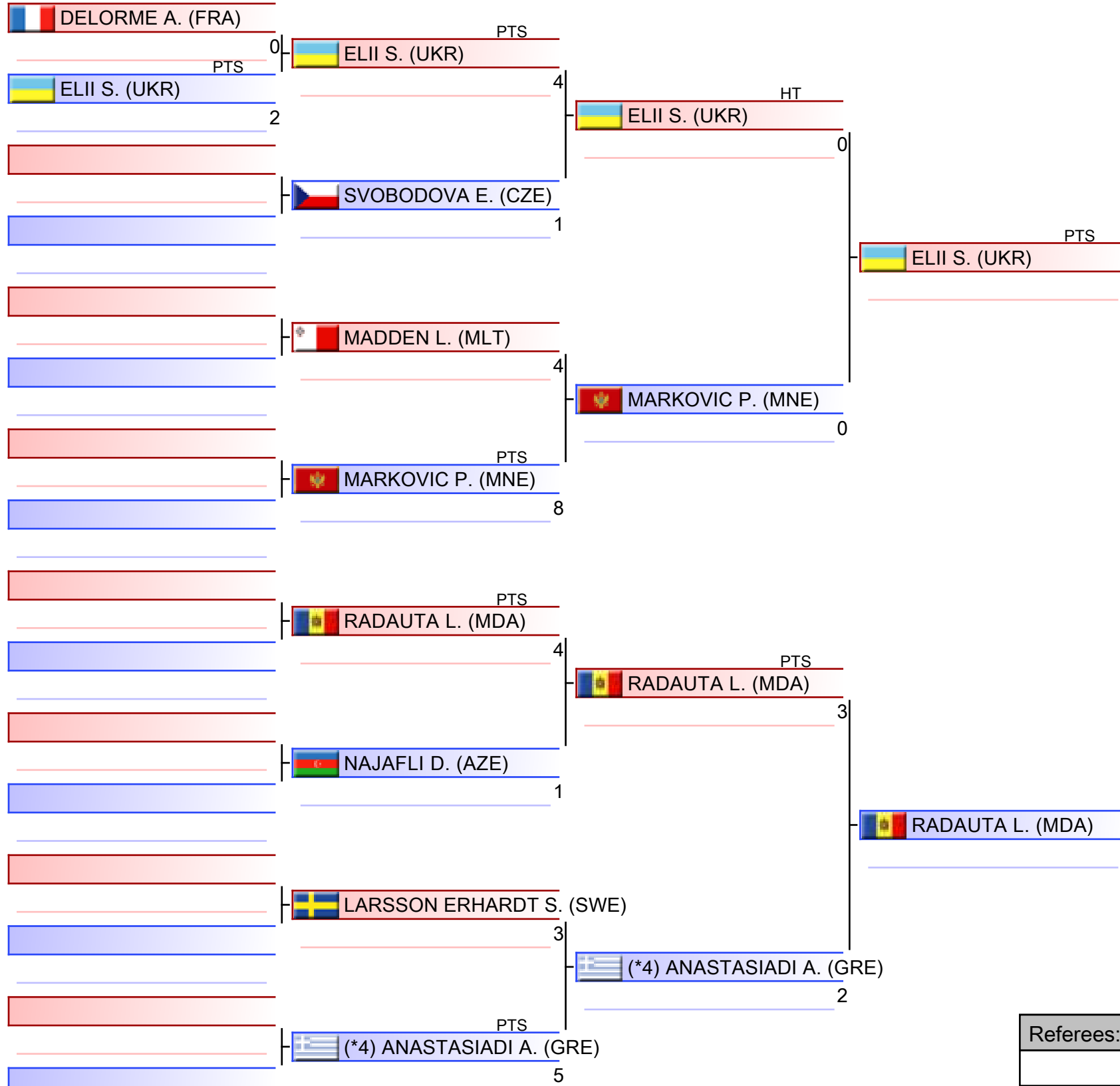

WKF
EUROPE

1. ELII SOFIIA (UKR)
2. KALOEVA KIRA (WKF-1)
3. BALANESCU IOANA (ROU)
3. CHICA TOLOSA ARIADNA (ESP)
5. MARKOVIC PETRA (MNE)
5. POSKIN EMILIE (BEL)
7. RADAUTA LOREDANA (MDA)
7. KUN REGINA KIRA (HUN)

*Seeded

Referees:			

Cadet Kumite Female -54 kg

EKF Junior, Cadet & U21 Championships 2026 - Limassol, Spyros Kyprianou Athletic Center, Limassol, CYP

2026-02-06

Tatami
4 13:50

Pool
4/4

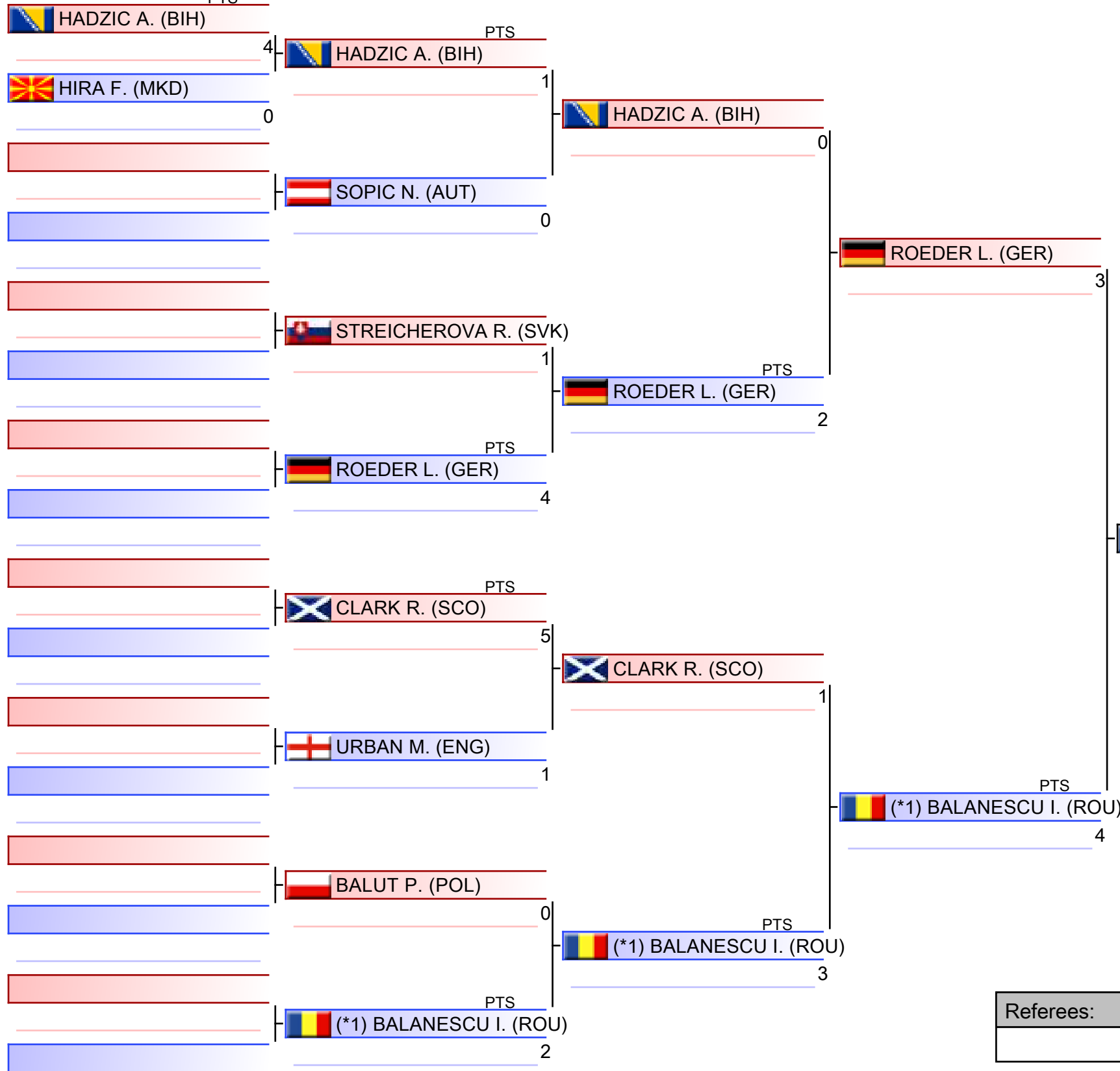

WKF
EUROPE

1. ELII SOFIIA (UKR)
2. KALOEVA KIRA (WKF-1)
3. BALANESCU IOANA (ROU)
3. CHICA TOLOSA ARIADNA (ESP)
5. MARKOVIC PETRA (MNE)
5. POSKIN EMILIE (BEL)
7. RADAUTA LOREDANA (MDA)
7. KUN REGINA KIRA (HUN)

*Seeded

Referees:			

Pool winner-Cadet Kumite Female -54 kg

EKF Junior, Cadet & U21 Championships 2026 - Limassol, Spyros Kyprianou Athletic Center, Limassol, CYP

2026-02-06

Tatami
3 14:35

Pool
1/1



WKF
EUROPE

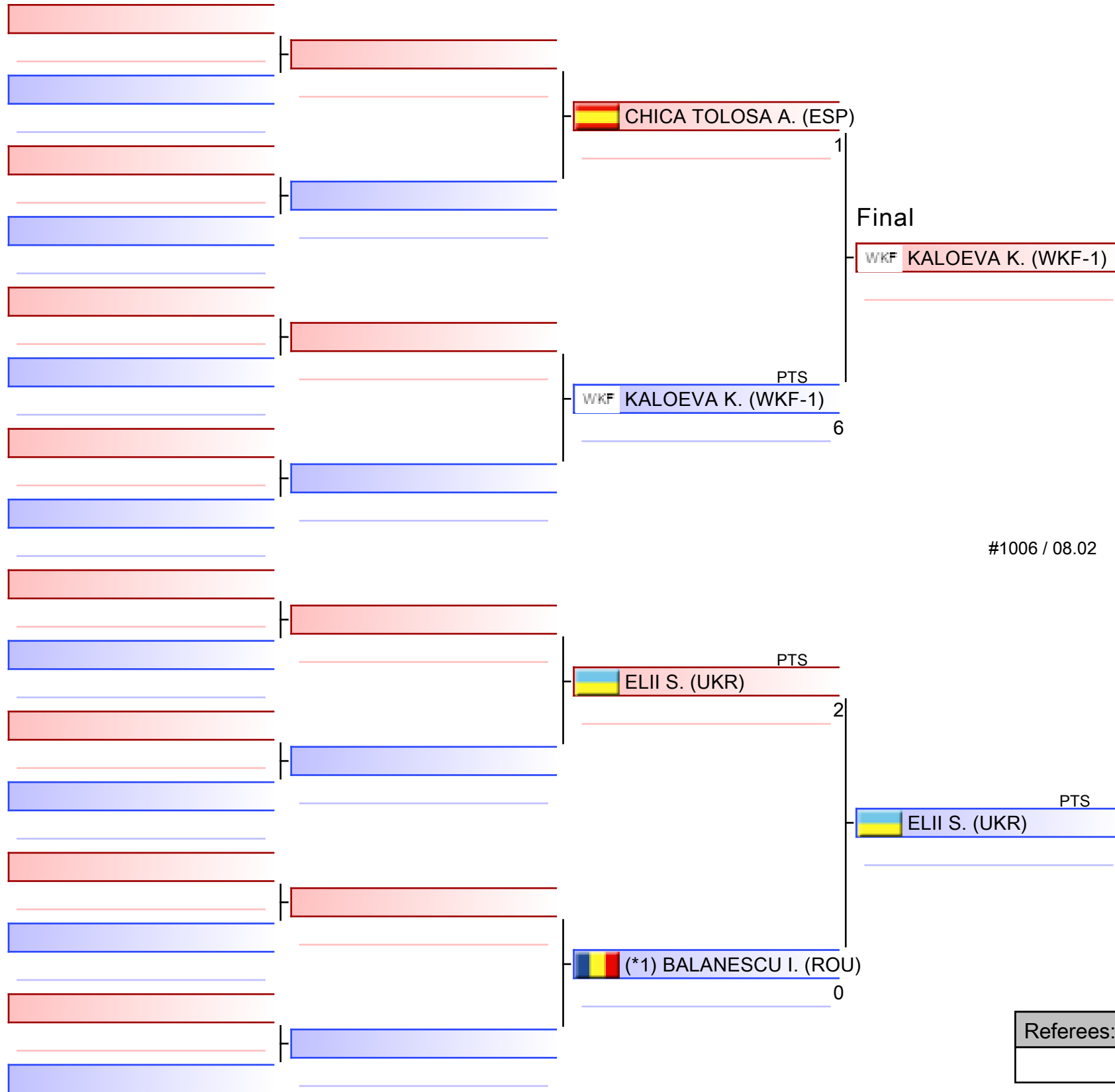

1. ELII SOFIIA (UKR)
2. KALOEVA KIRA (WKF-1)
3. BALANESCU IOANA (ROU)
3. CHICA TOLOSA ARIADNA (ESP)
5. MARKOVIC PETRA (MNE)
5. POSKIN EMILIE (BEL)
7. RADAUTA LOREDANA (MDA)
7. KUN REGINA KIRA (HUN)

*Seeded

Referees:			

Cadet Kumite Female -54 kg

EKF Junior, Cadet & U21 Championships 2026 - Limassol

2026-02-06

Tatami
2 15:55

Pool
1,2,3,4

(c)sportdata GmbH & Co KG 2000-2026 (2026-02-08 17:46) v 11.0.0 build 2 (2025-01-21 11:49 CET) License: SDIL TWG2025 (expire 2026-09-30)

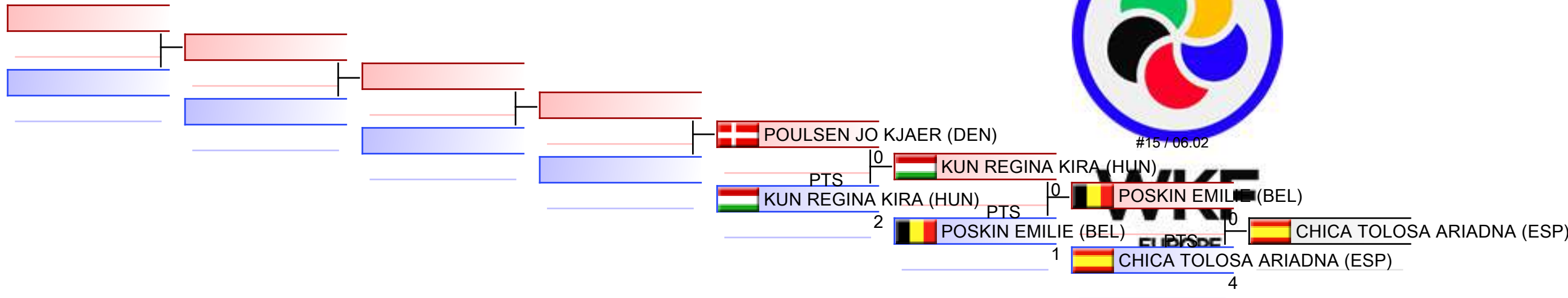

REPECHAGE: (1,2,3,4)

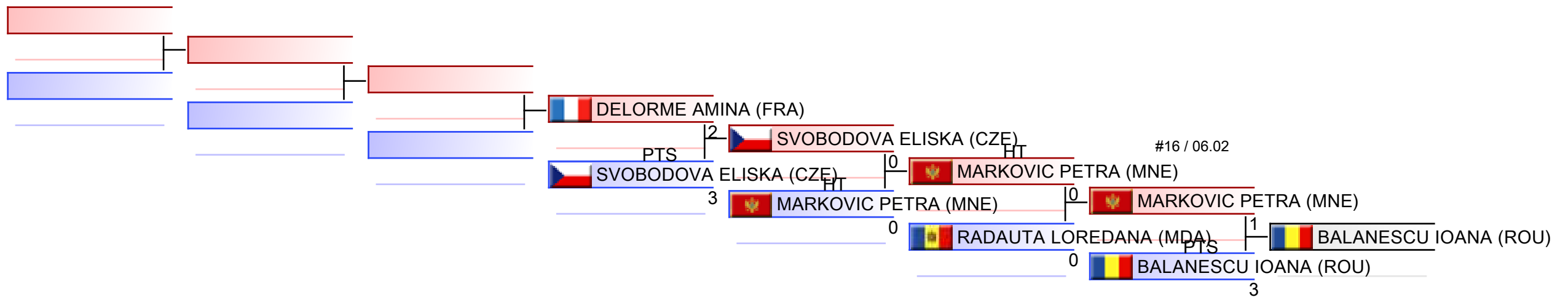

Referees:							
-----------	--	--	--	--	--	--	--



EKF Junior, Cadet & U21 Championships
2026 - Limassol - 2026-02-06



Official Results

Cadet Kumite Female -54 kg			
1	ELII SOFIIA		UKR - UKRAINE
2	KALOEVA KIRA		WKF-1 - WKF-1
3	BALANESCU IOANA		ROU - ROMANIA
3	CHICA TOLOSA ARIADNA		ESP - SPAIN
5	MARKOVIC PETRA		MNE - MONTENEGRO
5	POSKIN EMILIE		BEL - BELGIUM
7	RADAUTA LOREDANA		MDA - MOLDOVA, REPUBLIC OF
7	KUN REGINA KIRA		HUN - HUNGARY
9	SVOBODOVA ELISKA		CZE - CZECH REPUBLIC
9	POULSEN JO KJAER		DEN - DENMARK
11	DELORME AMINA		FRA - FRANCE

CADET KUMITE FEMALE -61 KG



EKF Junior, Cadet & U21 Championships 2026 - Lim..



ENTRIES BY WEIGHT CATEGORY

Cadet Kumite Female -61 kg

As of 8 FEB 2026

Code	ID	Gender	Name	Seeding
ALB	ALB02267	F	BACKA ISRA	
AZE	AZE03300	F	TARVERDI AYSU	
BIH	BIH03680	F	HUKARA SARA	
BUL	BUL003103	F	GEORGIEVA STEFANI	
CRO	CRO03588	F	PANIC PAULA	1
CYP	CYP03093	F	TUTIC HANA	
CZE	CZE003194	F	SIMPSON LILIANA	
DEN	DEN003040	F	BISGAARD IDA	
ENG	ENG003392	F	BERRY LAUREN	
ESP	ESP03602	F	GINES CHAVARRY PAULA	
FIN	FIN002827	F	STEFANSKI VANESSA	
FRA	FRA004507	F	KAKICHE MANOUA	
GEO		F	KHUROSHVILI BARBARE	
GER	GER004223	F	MEYEN SELDA	3
GRE	GRE02755	F	ANASTASIADI MARINA	
IRL	IRL003209	F	MCDERMOTT MICHAELA	
ISR	ISR003242	F	BULATNIKOV NADIN	
ITA	ITA005909	F	GENOCCHIO ISABEL	
LAT	LAT002971	F	SELAVKO OLGA	
LTU	LTU002735	F	STAVECKAITE BARBORA	
LUX	LUX02680	F	DURRER NAHIMA	
MKD	MKD03257	F	FRANGU HENA	
MNE	MNE03041	F	BLECIC DEJANA	
NED	NED003572	F	VAN KEULEN NORAH	
NOR	NOR002975	F	RYBALKO MARINA	
POL	POL3395	F	SZUBA NIKOLA	4
POR	POR003478	F	PINTO MATILDE	
ROU	ROU03597	F	POPESCU BIANCA	
SCO	SCO002730	F	DUFF JULIA	
SLO	SLO02855	F	MASTNAK MIA	
SRB	SRB04113	F	NIKOLIC NATASA	
SVK	SVK003246	F	GASPAROVA JESSICA	2
UKR	UKR003921	F	POPOVA DIANA	
WKF-1	WKF105251	F	VOLIK ANNA	

Cadet Kumite Female -61 kg

EKF Junior, Cadet & U21 Championships 2026 - Limassol, Spyros Kyprianou Athletic Center, Limassol, CYP

2026-02-06

Tatami
5 13:05

Pool
1/4

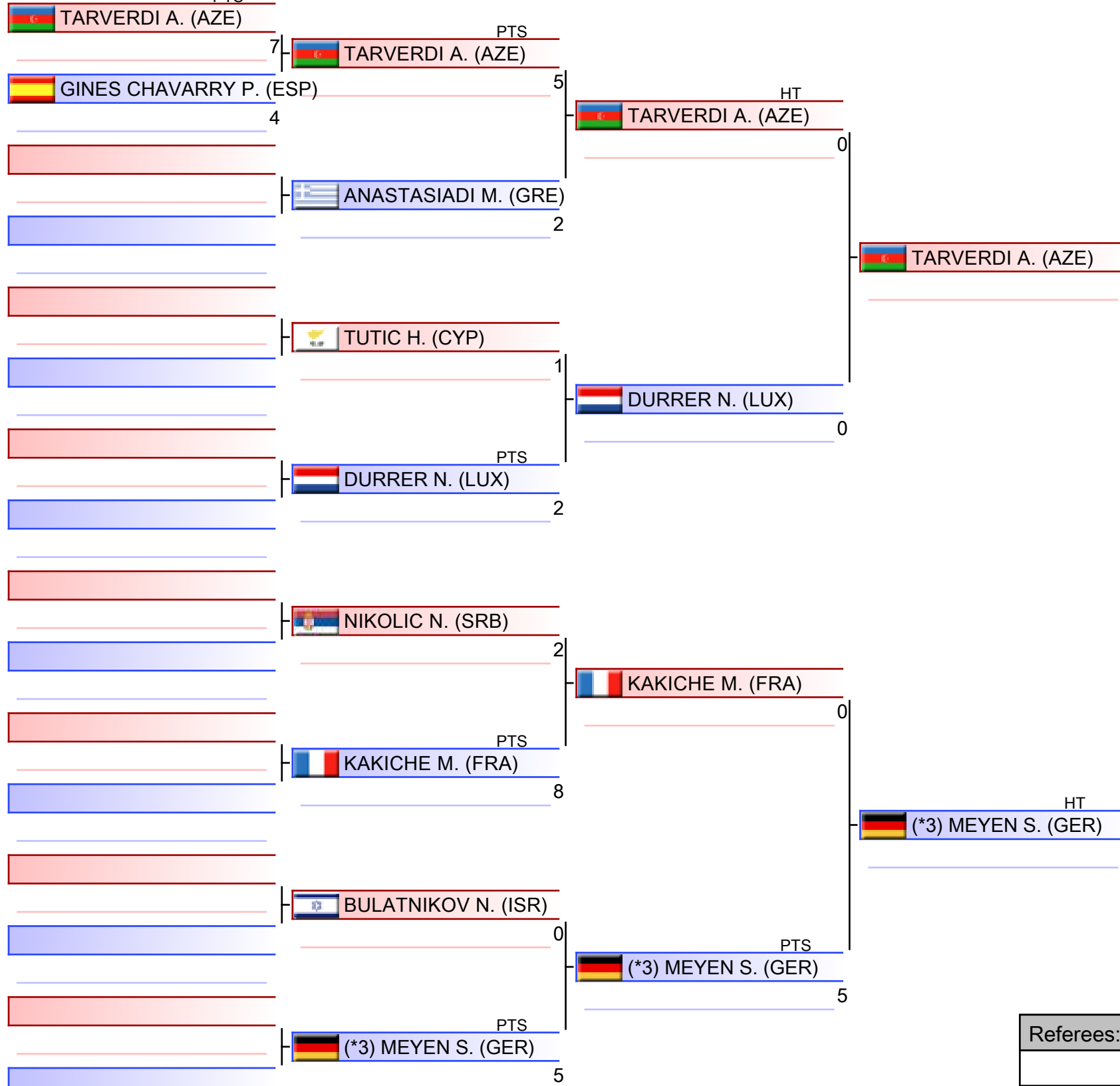

WKF
EUROPE

(*3) MEYEN S. (GER)

1. VOLIK ANNA (WKF-1)
2. POPOVA DIANA (UKR)
3. MEYEN SELDA (GER)
3. DUFF JULIA (SCO)
5. GASPAROVA JESSICA (SVK)
5. POPESCU BIANCA (ROU)
7. GEORGIEVA STEFANI (BUL)
7. STAVECKAITE BARBORA (LTU)

*Seeded

Referees:			

Cadet Kumite Female -61 kg

EKF Junior, Cadet & U21 Championships 2026 - Limassol, Spyros Kyprianou Athletic Center, Limassol, CYP

2026-02-06

Tatami
5 13:50

Pool
2/4



WKF
EUROPE

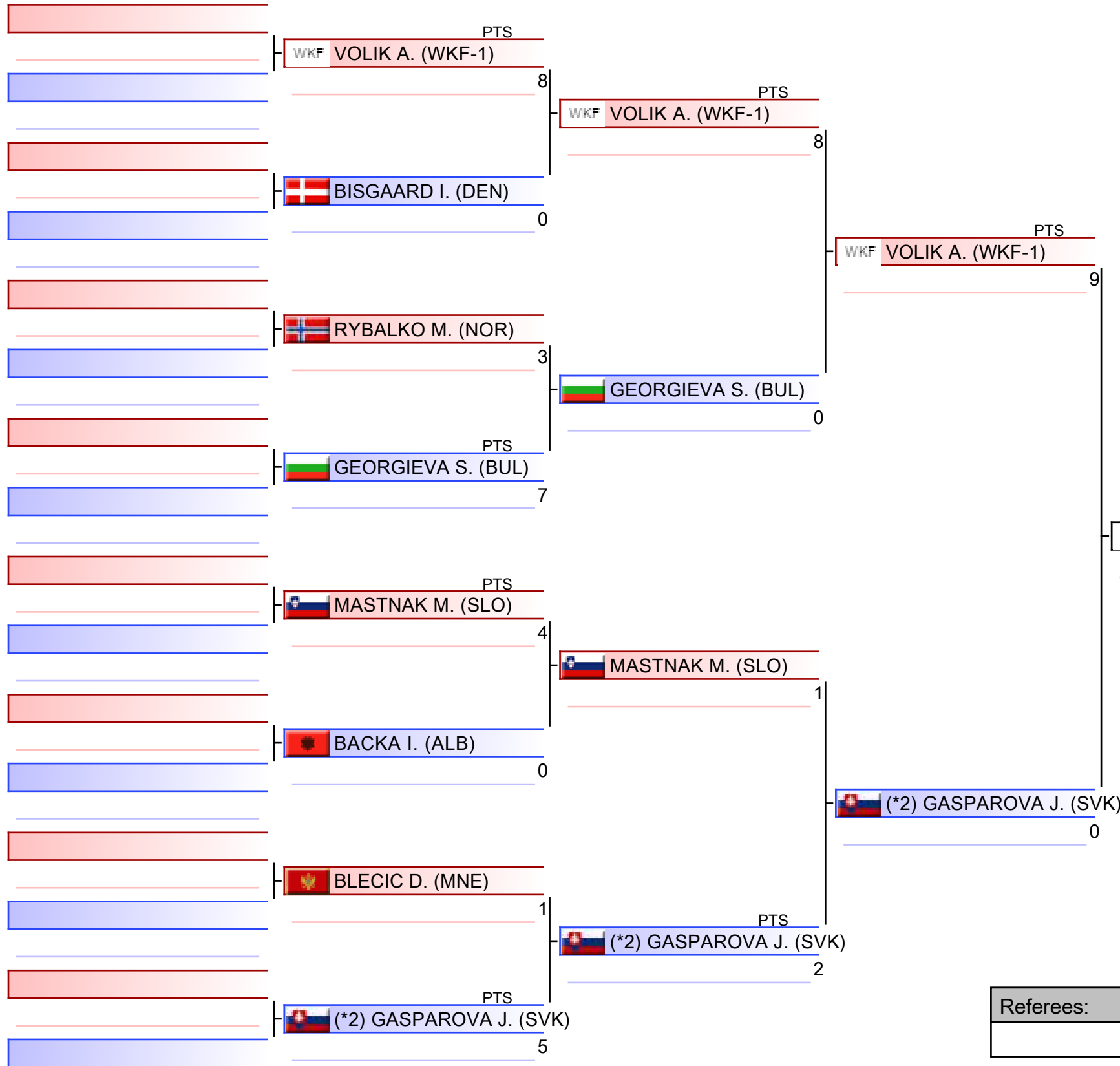

WKF VOLIK A. (WKF-1)

1. VOLIK ANNA (WKF-1)
2. POPOVA DIANA (UKR)
3. MEYEN SELDA (GER)
3. DUFF JULIA (SCO)
5. GASPAROVA JESSICA (SVK)
5. POPESCU BIANCA (ROU)
7. GEORGIEVA STEFANI (BUL)
7. STAVECKAITE BARBORA (LTU)

*Seeded

Referees:			

Cadet Kumite Female -61 kg

EKF Junior, Cadet & U21 Championships 2026 - Limassol, Spyros Kyprianou Athletic Center, Limassol, CYP

2026-02-06

Tatami
6 13:05

Pool
3/4

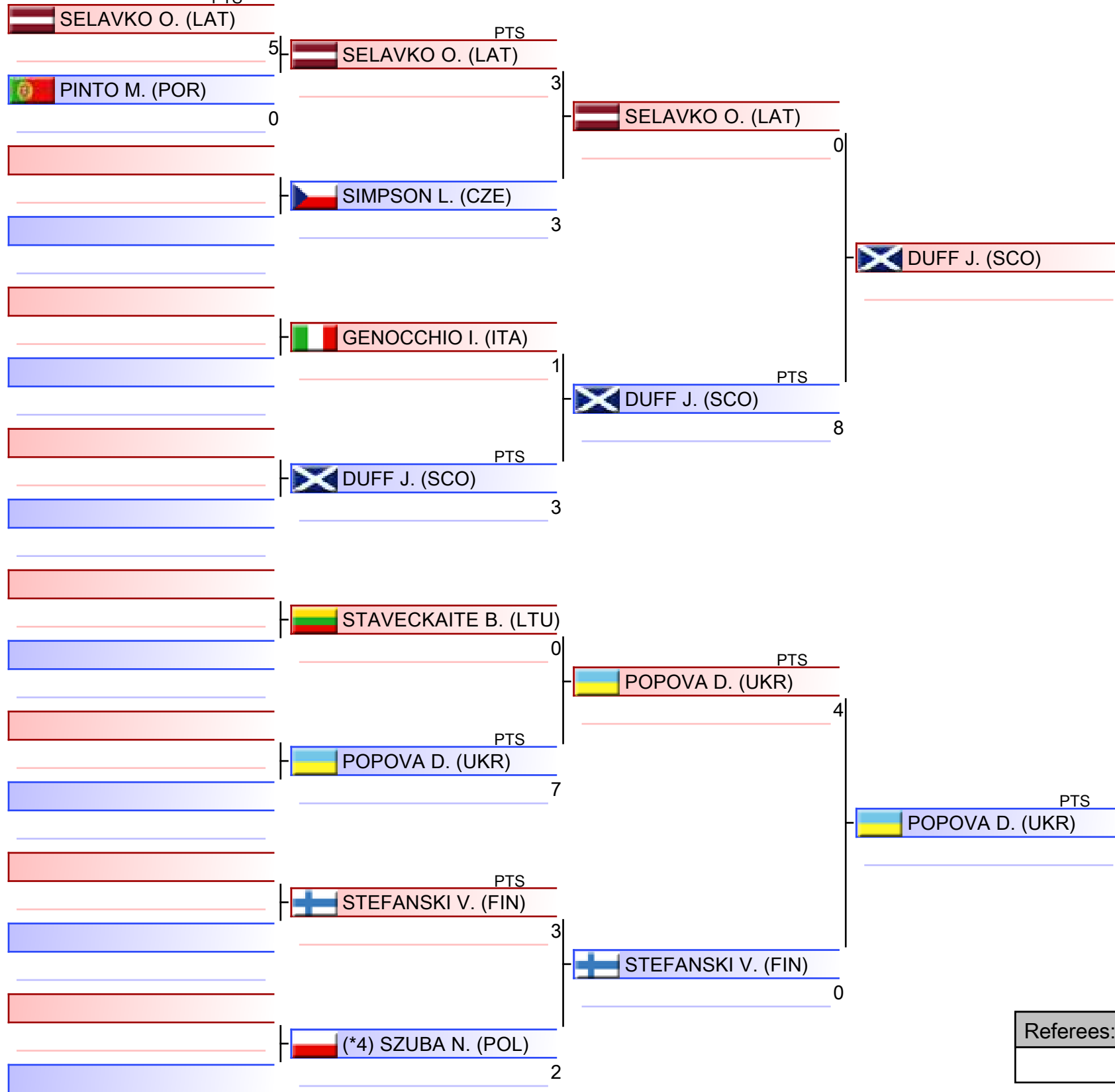

WKF
EUROPE

1. VOLIK ANNA (WKF-1)
2. POPOVA DIANA (UKR)
3. MEYEN SELDA (GER)
3. DUFF JULIA (SCO)
5. GASPAROVA JESSICA (SVK)
5. POPESCU BIANCA (ROU)
7. GEORGIEVA STEFANI (BUL)
7. STAVECKAITE BARBORA (LTU)

*Seeded

Referees:			

Cadet Kumite Female -61 kg

EKF Junior, Cadet & U21 Championships 2026 - Limassol, Spyros Kyprianou Athletic Center, Limassol, CYP

2026-02-06

Tatami
6 13:50

Pool
4/4

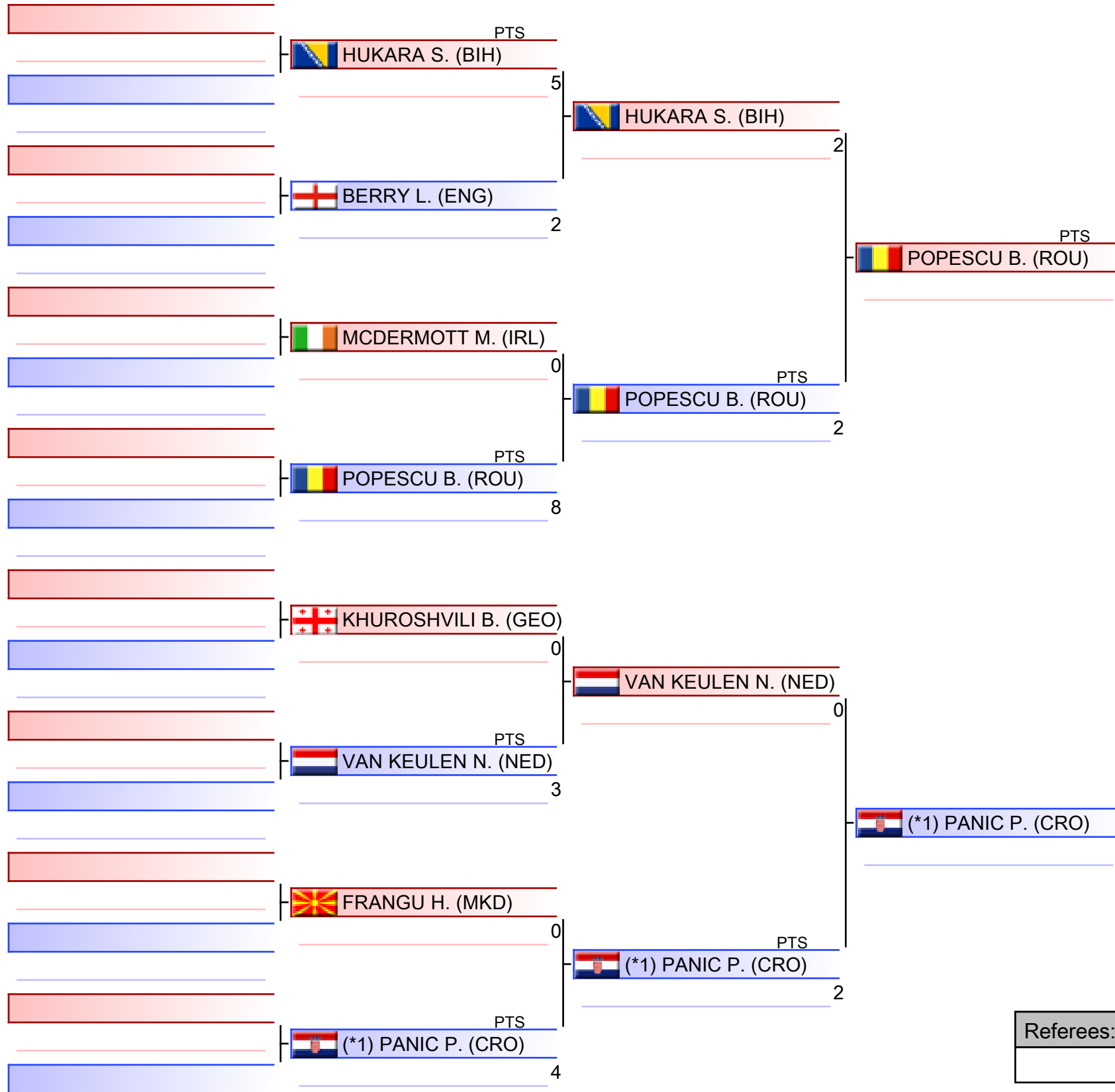

WKF
EUROPE

1. VOLIK ANNA (WKF-1)
2. POPOVA DIANA (UKR)
3. MEYEN SELDA (GER)
3. DUFF JULIA (SCO)
5. GASPAROVA JESSICA (SVK)
5. POPESCU BIANCA (ROU)
7. GEORGIEVA STEFANI (BUL)
7. STAVECKAITE BARBORA (LTU)

*Seeded

Referees:			

Pool winner-Cadet Kumite Female -61 kg

EKF Junior, Cadet & U21 Championships 2026 - Limassol, Spyros Kyprianou Athletic Center, Limsassol, CYP

2026-02-06

Tatami
5 14:30

Pool
1/1

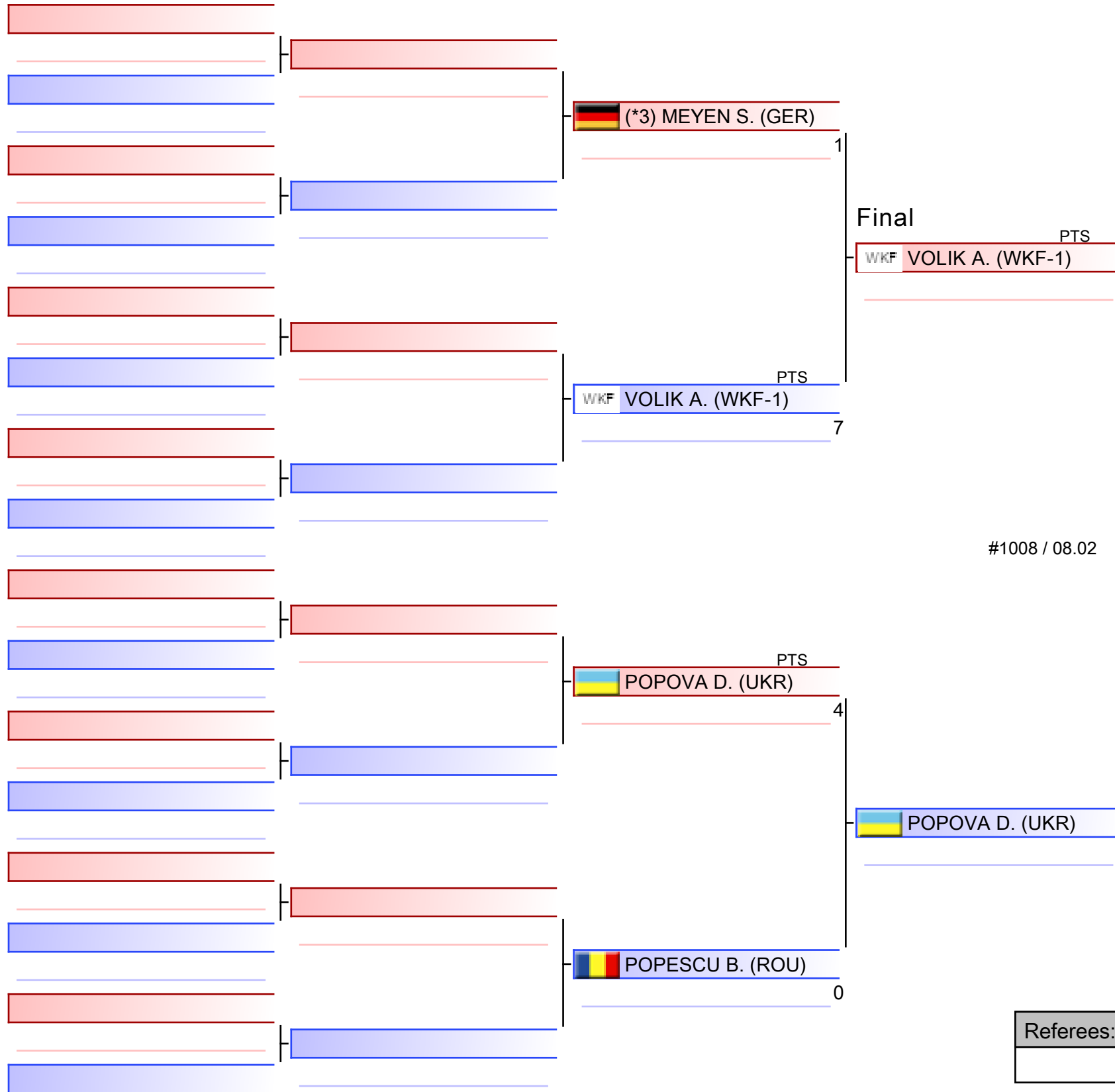

1. VOLIK ANNA (WKF-1)
2. POPOVA DIANA (UKR)
3. MEYEN SELDA (GER)
3. DUFF JULIA (SCO)
5. GASPAROVA JESSICA (SVK)
5. POPESCU BIANCA (ROU)
7. GEORGIEVA STEFANI (BUL)
7. STAVECKAITE BARBORA (LTU)

*Seeded

Referees:			

Cadet Kumite Female -61 kg

EKF Junior, Cadet & U21 Championships 2026 - Limassol

2026-02-06

Tatami
3 16:00

Pool
1,2,3,4

(c)sportdata GmbH & Co KG 2000-2026 (2026-02-08 17:46) v 11.0.0 build 2 (2025-01-21 11:49 CET) License: SDIL TWG2025 (expire 2026-09-30)

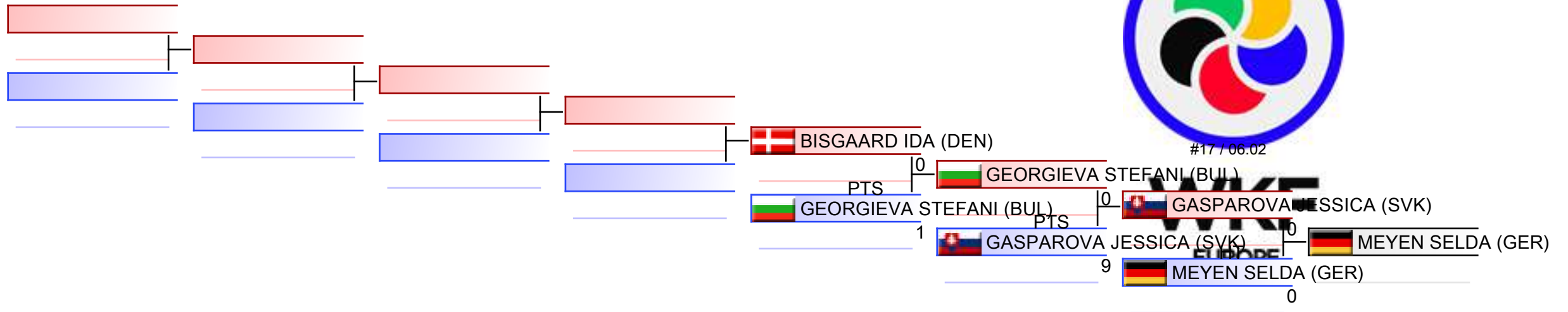

REPECHAGE: (1,2,3,4)

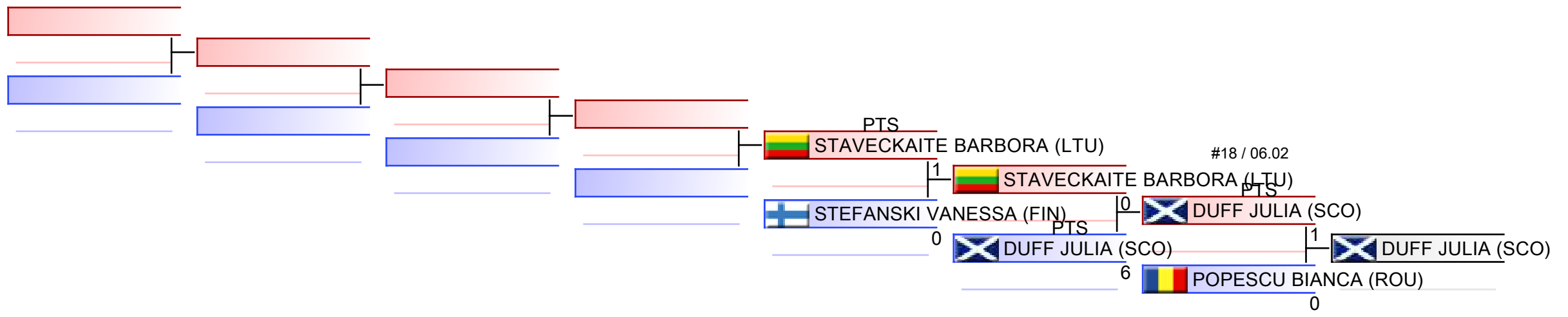

Referees:							
-----------	--	--	--	--	--	--	--



EKF Junior, Cadet & U21 Championships
2026 - Limassol - 2026-02-06



Official Results

Cadet Kumite Female -61 kg			
1	VOLIK ANNA		WKF-1 - WKF-1
2	POPOVA DIANA		UKR - UKRAINE
3	MEYEN SELDA		GER - GERMANY
3	DUFF JULIA		SCO - SCOTLAND
5	GASPAROVA JESSICA		SVK - SLOVAKIA
5	POPESCU BIANCA		ROU - ROMANIA
7	GEORGIEVA STEFANI		BUL - BULGARIA
7	STAVECKAITE BARBORA		LTU - LITHUANIA
9	BISGAARD IDA		DEN - DENMARK
9	STEFANSKI VANESSA		FIN - FINLAND

CADET KUMITE FEMALE 61+ KG



EKF Junior, Cadet & U21 Championships 2026 - Lim..



ENTRIES BY WEIGHT CATEGORY

Cadet Kumite Female 61+ kg

As of 8 FEB 2026

Code	ID	Gender	Name	Seeding
ALB	ALB002809	F	REXHEPI LANIKA	3
AZE	AZE003632	F	KAZIMOVA MADINA	
BIH	BIH03794	F	HUSIC DALAL	
BUL	BUL003162	F	LABADA YULIANA	
CRO	CRO03358	F	BARUKCIC ANA MARIE	2
CYP	CYP03098	F	EFTHYMIOU VALERIA	
CZE	CZE02716	F	KASIK KLAUDIA	
ENG	ENG003599	F	HANDLEY SKYLA	
ESP	ESP004323	F	NUNEZ ABREU NAGORE	
EST	EST002777	F	FOMKINA ARINA	
FRA	FRA004306	F	ESSABAR MERYEM	
GEO	GEO003029	F	AMBARYAN LIKA	
GER	GER004069	F	KONRADI ARWEN	
GRE	GRE03062	F	PERGALIA ANASTASIA-EIRINI	4
HUN	HUN003511	F	MAYERHOFFER MERI	
IRL	IRL003211	F	KELLY REBECCA	
ITA	ITA005913	F	ONORI SOFIA	
LAT	LAT003163	F	AVRUSKINA JELIZAVETA	
LTU	LTU002736	F	BUTKUTE AUSTEJA	
MKD	MKD03250	F	SELA BUNA	
MNE	MNE03115	F	DJOROJEVIC GORANA	
NOR	NOR002867	F	BRENNE LINNES LEA	
POL	POL08975	F	WOZNIAK MAJA	
POR	POR003364	F	SANTOS MADALENA	1
ROU	ROU003857	F	MARIA CARINA POPESCU	
SCO	SCO002914	F	WALKER LUCY	
SRB	SRB03513	F	MACURA NINA	
SVK	SVK003452	F	SEVCIKOVA VIKTORIA	
UKR	UKR003680	F	CHUMAK ALIKA	
WKF-1	WKF105721	F	DANILOVA SOFIA	

Cadet Kumite Female 61+ kg

EKF Junior, Cadet & U21 Championships 2026 - Limassol, Spyros Kyprianou Athletic Center, Limassol, CYP

2026-02-06

Tatami
7 13:05

Pool
1/4



WKF
EUROPE

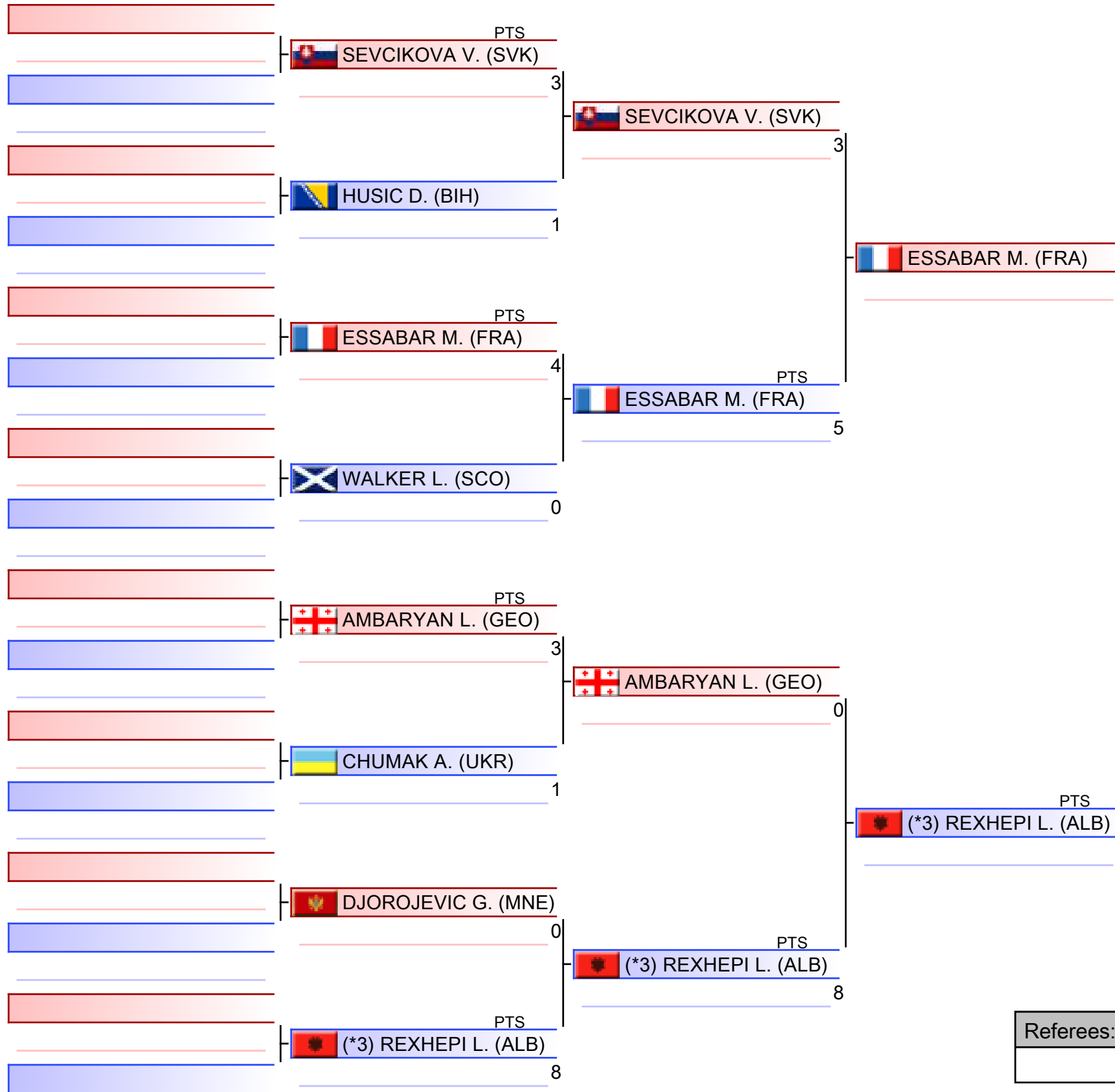

(*3) REXHEPI L. (ALB)

1. SANTOS MADALENA (POR)
2. REXHEPI LANIKA (ALB)
3. ESSABAR MERYEM (FRA)
3. DANILOVA SOFIA (WKF-1)
5. ONORI SOFIA (ITA)
5. MARIA CARINA POPESCU (ROU)
7. AMBARYAN LIKA (GEO)
7. NUNEZ ABREU NAGORE (ESP)

*Seeded

Referees:			

Cadet Kumite Female 61+ kg

EKF Junior, Cadet & U21 Championships 2026 - Limassol, Spyros Kyprianou Athletic Center, Limassol, CYP

2026-02-06

Tatami
7 13:45

Pool
2/4



WKF
EUROPE

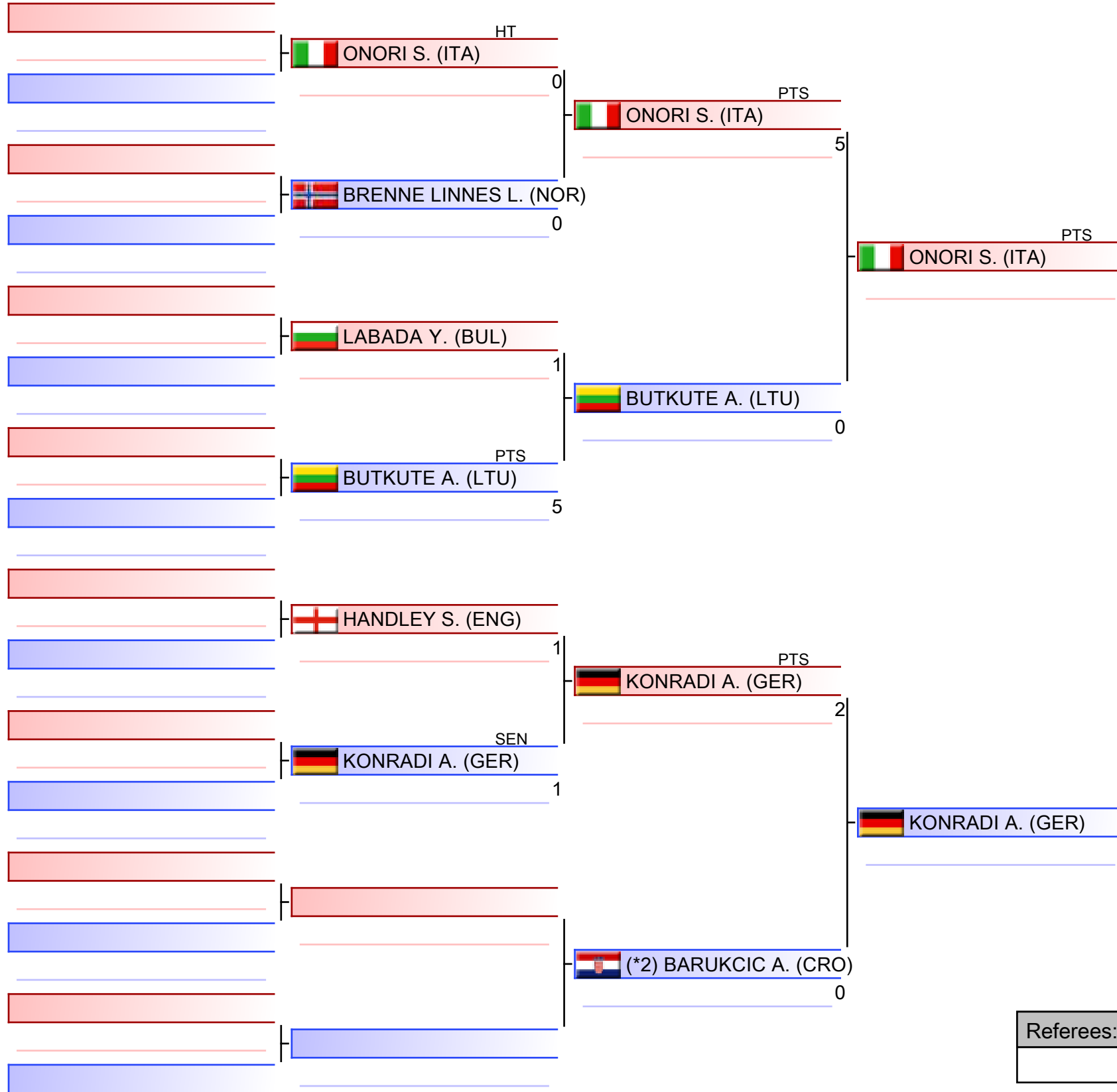

ONORI S. (ITA)

1. SANTOS MADALENA (POR)
2. REXHEPI LANIKA (ALB)
3. ESSABAR MERYEM (FRA)
3. DANILOVA SOFIA (WKF-1)
5. ONORI SOFIA (ITA)
5. MARIA CARINA POPESCU (ROU)
7. AMBARYAN LIKA (GEO)
7. NUNEZ ABREU NAGORE (ESP)

*Seeded

Referees:			

Cadet Kumite Female 61+ kg

EKF Junior, Cadet & U21 Championships 2026 - Limassol, Spyros Kyprianou Athletic Center, Limassol, CYP

2026-02-06

Tatami
8 13:05

Pool
3/4

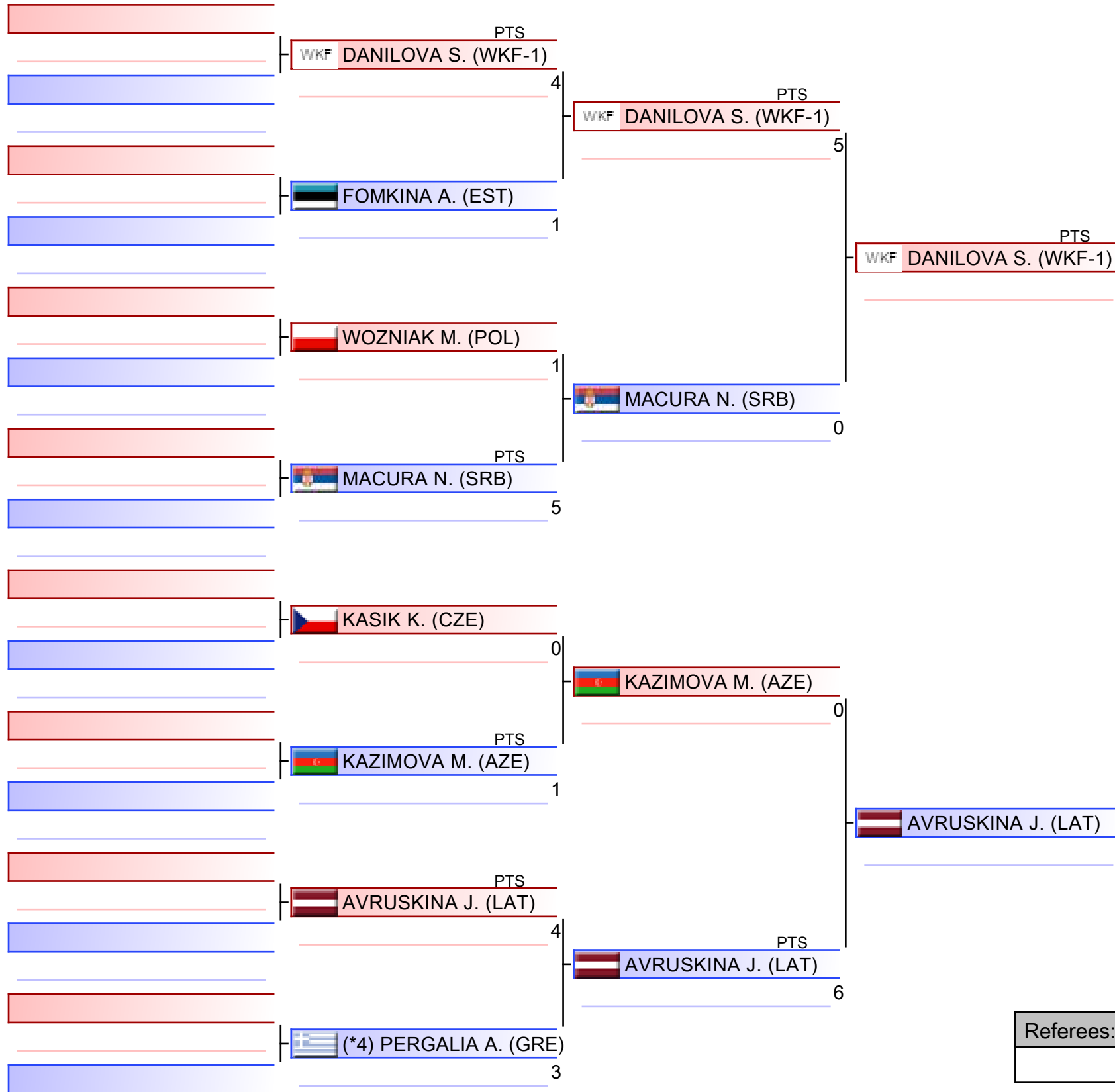

WKF
EUROPE

WKF **DANILOVA S. (WKF-1)**

1. SANTOS MADALENA (POR)
2. REXHEPI LANIKA (ALB)
3. ESSABAR MERYEM (FRA)
3. DANILOVA SOFIA (WKF-1)
5. ONORI SOFIA (ITA)
5. MARIA CARINA POPESCU (ROU)
7. AMBARYAN LIKA (GEO)
7. NUNEZ ABREU NAGORE (ESP)

*Seeded

Referees:			

Cadet Kumite Female 61+ kg

EKF Junior, Cadet & U21 Championships 2026 - Limassol, Spyros Kyprianou Athletic Center, Limassol, CYP

2026-02-06

Tatami
8 13:45

Pool
4/4



WKF
EUROPE

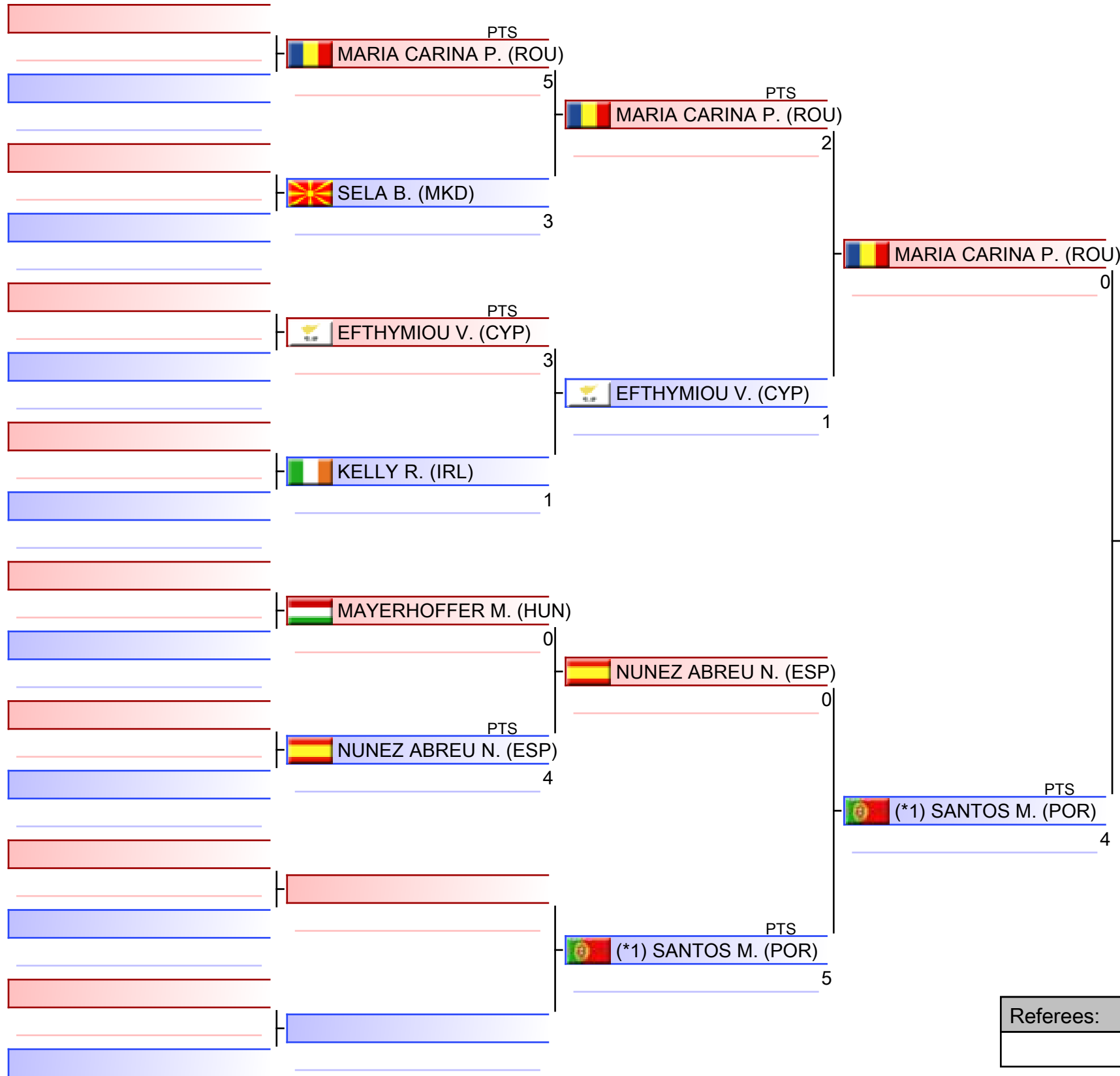

(*1) Santos M. (POR)

1. SANTOS MADALENA (POR)
2. REXHEPI LANIKA (ALB)
3. ESSABAR MERYEM (FRA)
3. DANILOVA SOFIA (WKF-1)
5. ONORI SOFIA (ITA)
5. MARIA CARINA POPESCU (ROU)
7. AMBARYAN LIKA (GEO)
7. NUNEZ ABREU NAGORE (ESP)

*Seeded

Referees:			

Pool winner-Cadet Kumite Female 61+ kg

EKF Junior, Cadet & U21 Championships 2026 - Limassol, Spyros Kyprianou Athletic Center, Limsassol, CYP

2026-02-06

Tatami
7 14:20

Pool
1/1



WKF
EUROPE

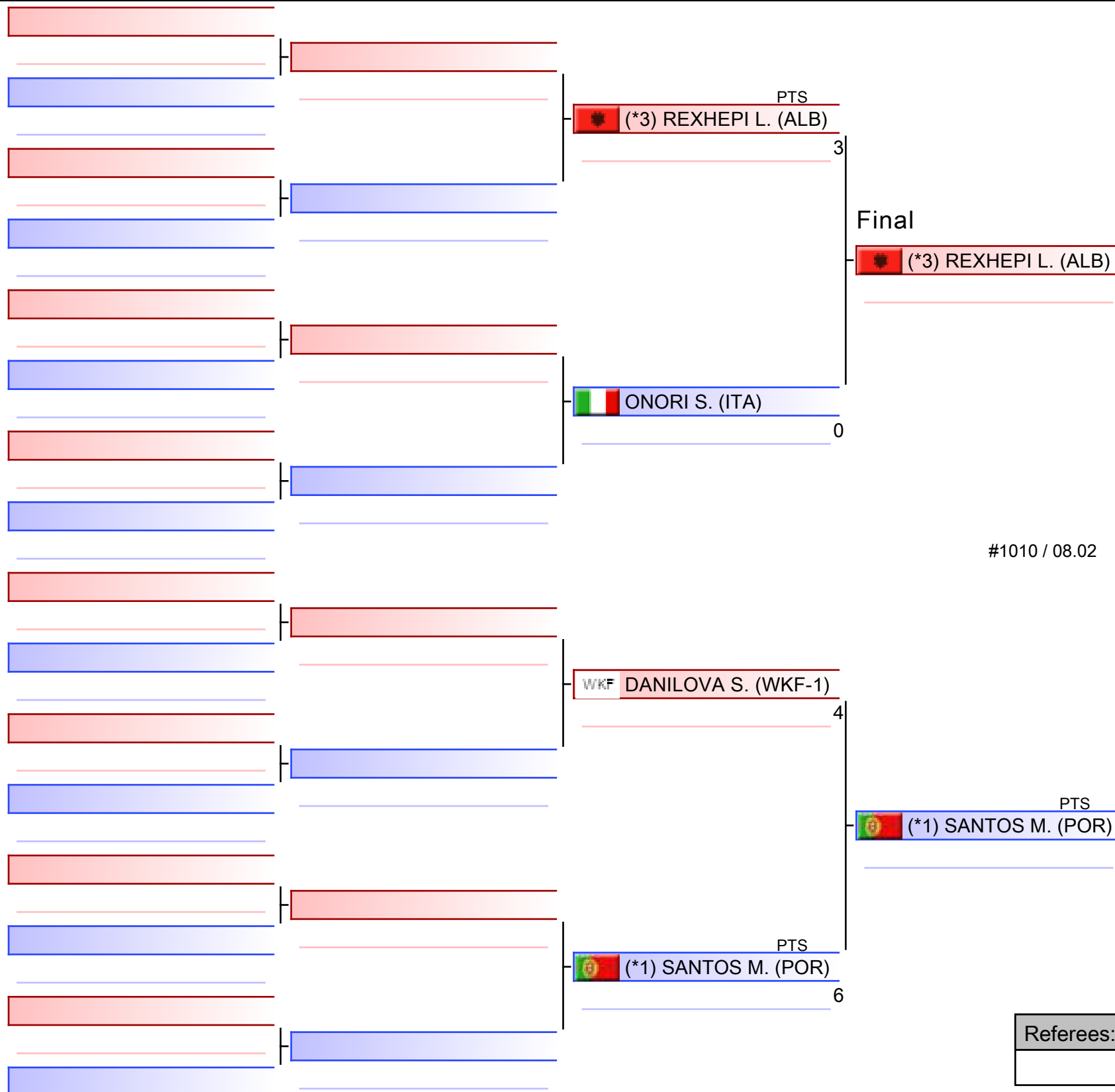

1. SANTOS MADALENA (POR)
2. REXHEPI LANIKA (ALB)
3. ESSABAR MERYEM (FRA)
3. DANILOVA SOFIA (WKF-1)
5. ONORI SOFIA (ITA)
5. MARIA CARINA POPESCU (ROU)
7. AMBARYAN LIKA (GEO)
7. NUNEZ ABREU NAGORE (ESP)

*Seeded

Referees:			

Cadet Kumite Female 61+ kg

EKF Junior, Cadet & U21 Championships 2026 - Limassol

2026-02-06

Tatami

1 16:20

Pool

1,2,3,4

(c)sportdata GmbH & Co KG 2000-2026 (2026-02-08 17:46) v 11.0.0 build 2 (2025-01-21 11:49 CET) License: SDIL TWG2025 (expire 2026-09-30)

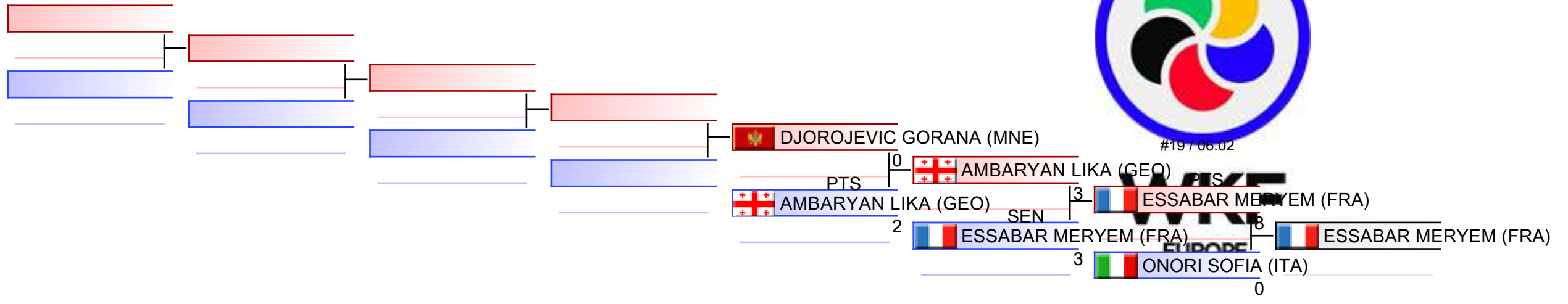

REPECHAGE: (1,2,3,4)

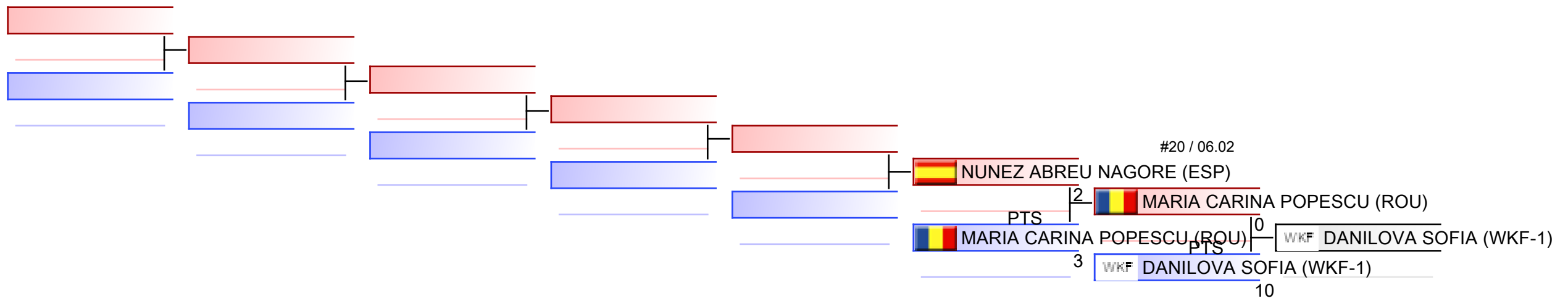

Referees:							
-----------	--	--	--	--	--	--	--



EKF Junior, Cadet & U21 Championships
2026 - Limassol - 2026-02-06



Official Results

Cadet Kumite Female 61+ kg			
1	SANTOS MADALENA		POR - PORTUGAL
2	REXHEPI LANIKA		ALB - ALBANIA
3	ESSABAR MERYEM		FRA - FRANCE
3	DANILOVA SOFIA		WKF-1 - WKF-1
5	ONORI SOFIA		ITA - ITALY
5	MARIA CARINA POPESCU		ROU - ROMANIA
7	AMBARYAN LIKA		GEO - GEORGIA
7	NUNEZ ABREU NAGORE		ESP - SPAIN
9	DJOROJEVIC GORANA		MNE - MONTENEGRO

CADET KUMITE MALE -52 KG



EKF Junior, Cadet & U21 Championships 2026 - Lim..



ENTRIES BY WEIGHT CATEGORY

Cadet Kumite Male -52 kg

As of 8 FEB 2026

Code	ID	Gender	Name	Seeding
ALB	ALB02577	M	HASANI NEEVIS	
ARM	ARM02971	M	SARGSYAN NAREK	
AUT	AUT03001	M	BLAGA ALEXANDRU	
AZE	AZE003459	M	RAFIYEV ABULFAZ	
BIH	BIH03968	M	MUHOVIC DAVUD	
BUL	BUL003090	M	NIKOLOV NIKOLA	
CRO	CRO03463	M	PANIC TINO	3
CYP	CYP03096	M	EFTHYMIU CONSTANTINOS	
DEN	DEN003043	M	FAGERLUND NYMARK WILLIAM	
ENG	ENG003609	M	MORGAN HARRY	
ESP	ESP004375	M	LOPEZ PEREZ HUGO	
FRA	FRA004510	M	BA DEMBA	
GEO	GEO02813	M	DADESHKELIANI LEVANI	1
GER	GER004277	M	FICHELTMANN ERIC	
GRE	GRE03047	M	MORAITIS IOANNIS-ADAMANTIOS	
HUN	HUN003512	M	PASZTOR SZABOLCS	
ISR	ISR02933	M	SAMADOV ILGAR	
ITA	ITA005925	M	CAFISO EDOARDO	
LAT	LAT003160	M	GREBNOVS ILJA	
LTU	LTU002702	M	SOKAS TADAS	
MDA	MDA02304	M	STAVARACHI RENAT	
MKD	MKD003755	M	MEMEDI MERVAN	
MNE	MNE02871	M	ALJOSEVIC ARIJAN	
NOR	NOR002903	M	KNUDSEN-TORP WILLIAM	
POL	POL06139	M	ZALESKI ANTONI	
POR	POR003563	M	SANTOS RUBEN	
ROU	ROU03584	M	MATEI SAVULESCU	2
SRB	SRB03746	M	HORVAT TODOR	4
SUI	SUI003341	M	LUETHY CORSIN DION	
SVK	SVK003402	M	MARCINEK MAXIM	
SWE	SWE003398	M	DURLING CHARLIE	
UKR	UKR003913	M	DOROSH MARK	
WKF-1	WKF105312	M	PEREVOZCHIKOV TIMUR	

Cadet Kumite Male -52 kg

EKF Junior, Cadet & U21 Championships 2026 - Limassol, Spyros Kyprianou Athletic Center, Limassol, CYP

2026-02-06

Tatami
1 14:30

Pool
1/4

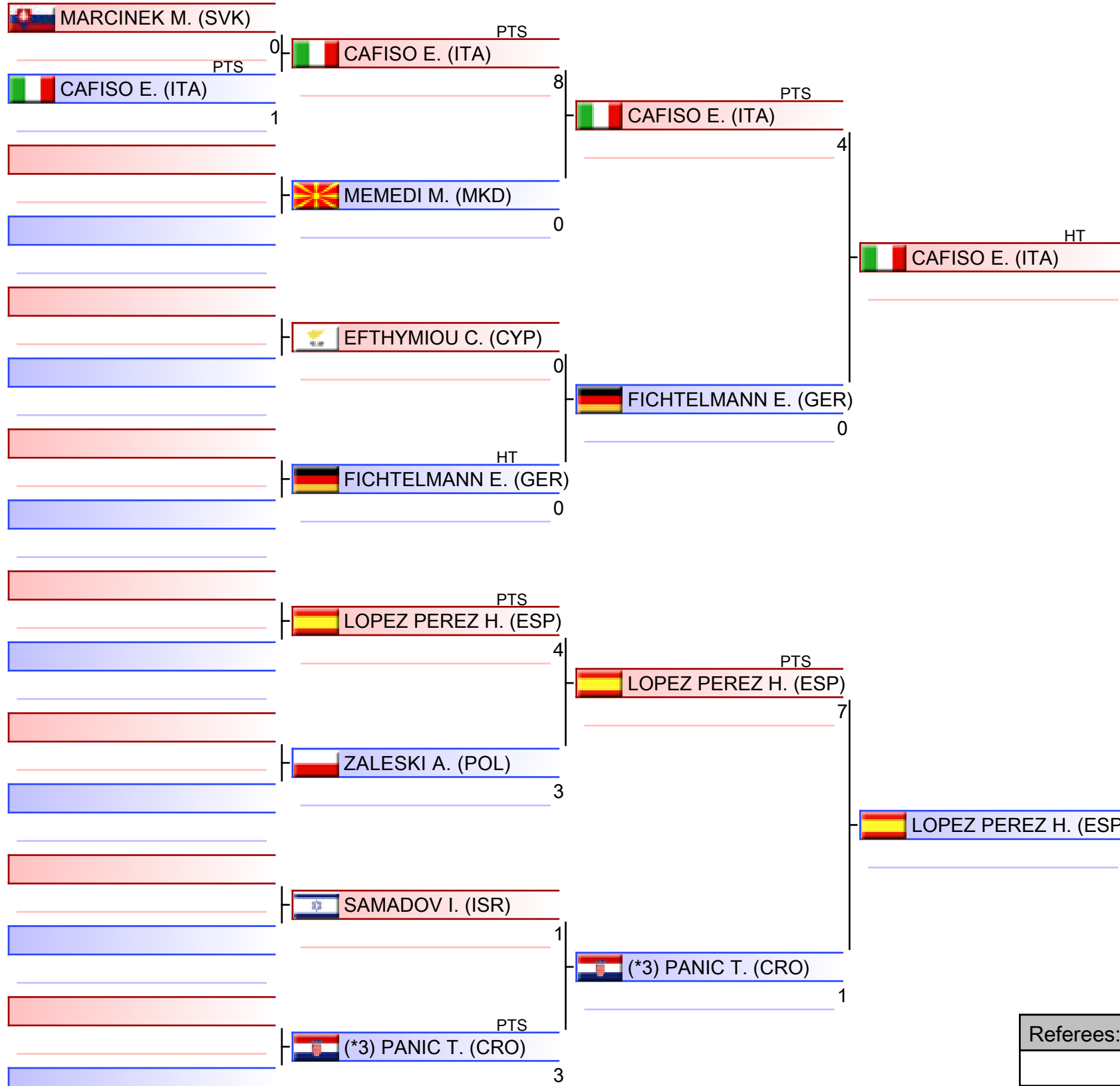

WKF
EUROPE

1. DOROSH MARK (UKR)
2. CAFISO EDOARDO (ITA)
3. DADESHKELIANI LEVANI (GEO)
3. HASANI NEEVIS (ALB)
5. MORAITIS IOANNIS-ADAMANTIOS (GRE)
5. LOPEZ PEREZ HUGO (ESP)
7. ALJOSEVIC ARIJAN (MNE)
7. MEMEDI MERVAN (MKD)

*Seeded

Referees:			

Cadet Kumite Male -52 kg

EKF Junior, Cadet & U21 Championships 2026 - Limassol, Spyros Kyprianou Athletic Center, Limassol, CYP

2026-02-06

Tatami
1 15:15

Pool
2/4



WKF
EUROPE

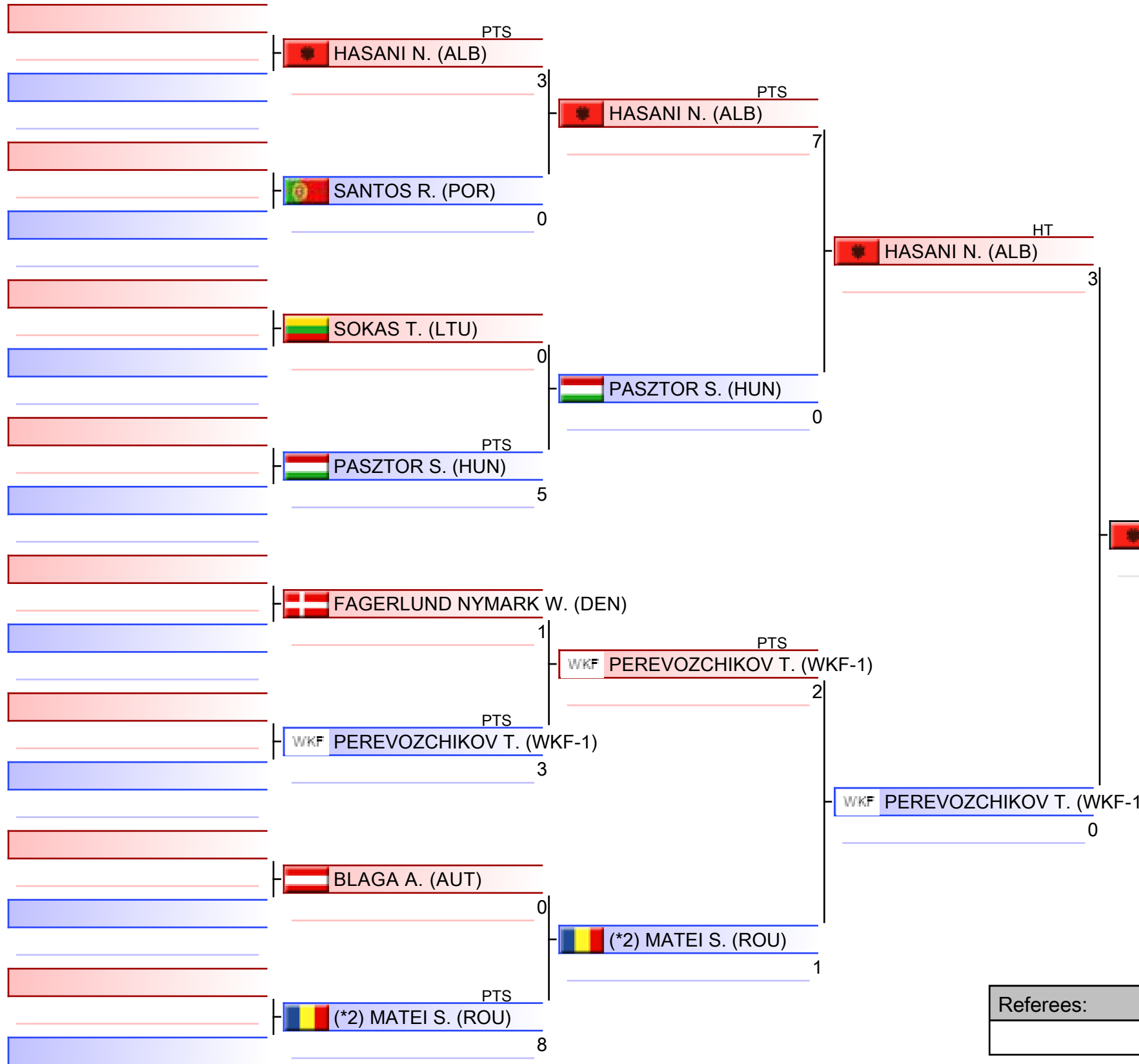

1. DOROSH MARK (UKR)
2. CAFISO EDOARDO (ITA)
3. DADESHKELIANI LEVANI (GEO)
3. HASANI NEEVIS (ALB)
5. MORAITIS IOANNIS-ADAMANTIOS (GRE)
5. LOPEZ PEREZ HUGO (ESP)
7. ALJOSEVIC ARIJAN (MNE)
7. MEMEDI MERVAN (MKD)

*Seeded

Referees:			

Cadet Kumite Male -52 kg

EKF Junior, Cadet & U21 Championships 2026 - Limassol, Spyros Kyprianou Athletic Center, Limassol, CYP

2026-02-06

Tatami
2 14:30

Pool
3/4



WKF
EUROPE

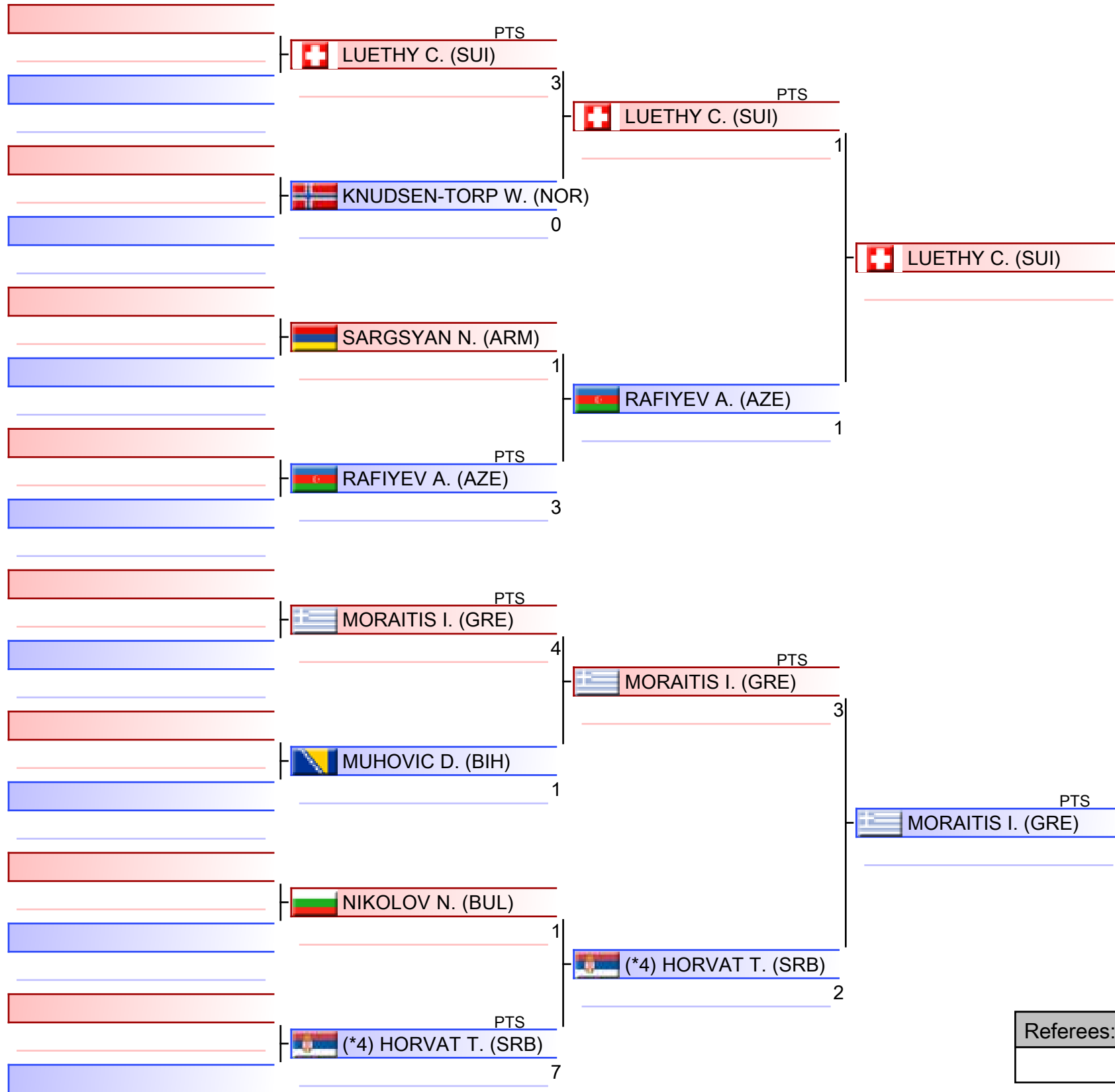

MORAITIS I. (GRE)

1. DOROSH MARK (UKR)
2. CAFISO EDOARDO (ITA)
3. DADSHKELIANI LEVANI (GEO)
3. HASANI NEEVIS (ALB)
5. MORAITIS IOANNIS-ADAMANTIOS (GRE)
5. LOPEZ PEREZ HUGO (ESP)
7. ALJOSEVIC ARIJAN (MNE)
7. MEMEDI MERVAN (MKD)

*Seeded

Referees:			

Cadet Kumite Male -52 kg

EKF Junior, Cadet & U21 Championships 2026 - Limassol, Spyros Kyprianou Athletic Center, Limassol, CYP

2026-02-06

Tatami
2 15:10

Pool
4/4



WKF
EUROPE

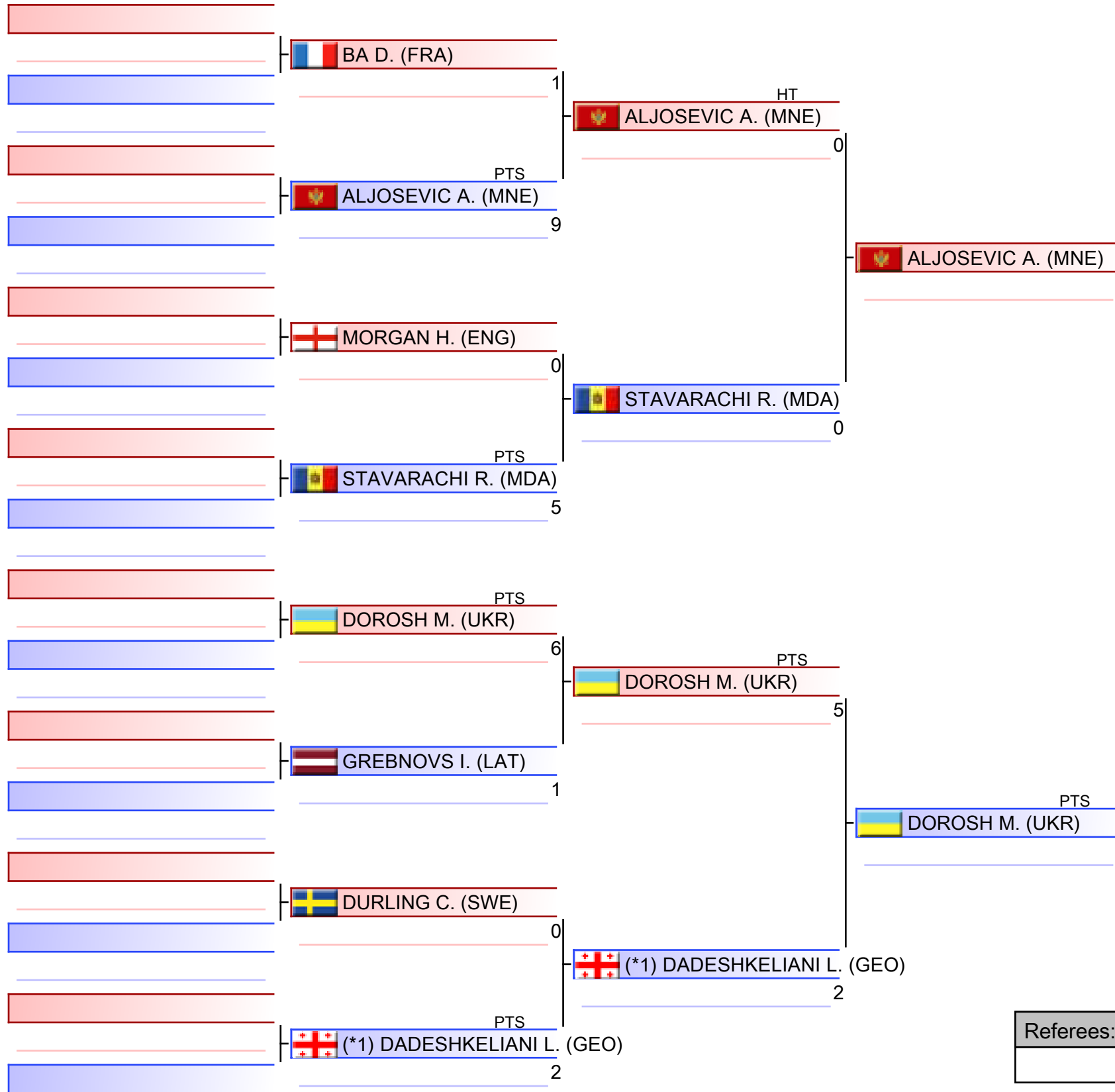

DOROSH M. (UKR)

1. DOROSH MARK (UKR)
2. CAFISO EDOARDO (ITA)
3. DADESHKELIANI LEVANI (GEO)
3. HASANI NEEVIS (ALB)
5. MORAITIS IOANNIS-ADAMANTIOS (GRE)
5. LOPEZ PEREZ HUGO (ESP)
7. ALJOSEVIC ARIJAN (MNE)
7. MEMEDI MERVAN (MKD)

*Seeded

Referees:			

Pool winner-Cadet Kumite Male -52 kg

EKF Junior, Cadet & U21 Championships 2026 - Limassol, Spyros Kyprianou Athletic Center, Limsassol, CYP

2026-02-06

Tatami
1 15:55

Pool
1/1



WKF
EUROPE

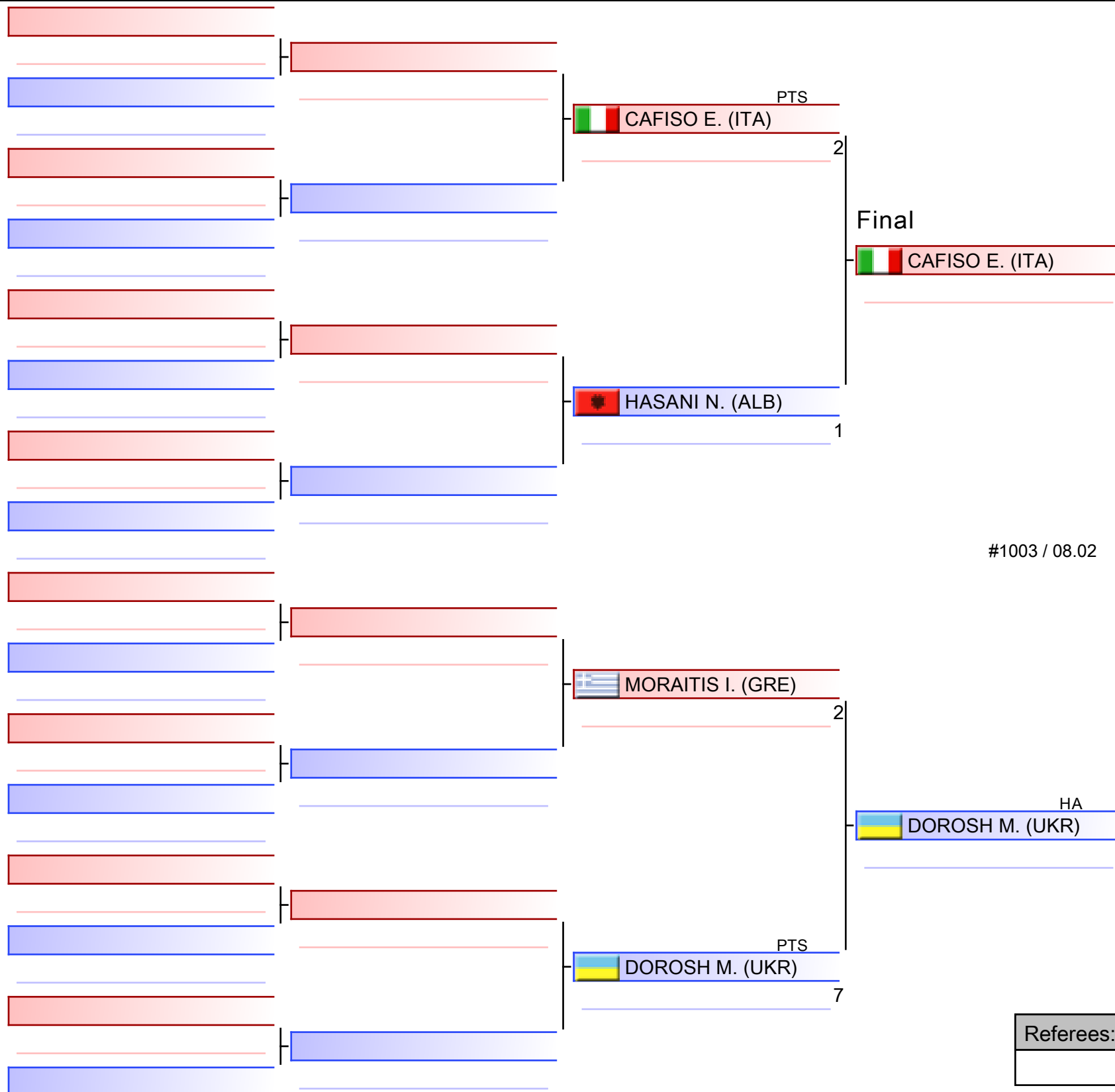

1. DOROSH MARK (UKR)
2. CAFISO EDOARDO (ITA)
3. DADESHKELIANI LEVANI (GEO)
3. HASANI NEEVIS (ALB)
5. MORAITIS IOANNIS-ADAMANTIOS (GRE)
5. LOPEZ PEREZ HUGO (ESP)
7. ALJOSEVIC ARIJAN (MNE)
7. MEMEDI MERVAN (MKD)

*Seeded

Referees:			

Cadet Kumite Male -52 kg

EKF Junior, Cadet & U21 Championships 2026 - Limassol

2026-02-06

Tatami
8 16:15

Pool
1,2,3,4

(c)sportdata GmbH & Co KG 2000-2026 (2026-02-08 17:46) v 11.0.0 build 2 (2025-01-21 11:49 CET) License: SDIL TWG2025 (expire 2026-09-30)

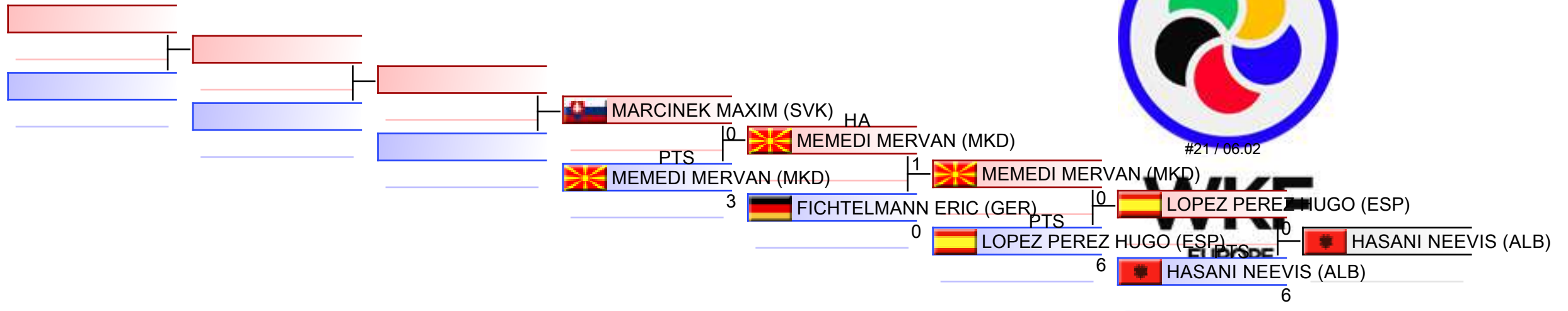

REPECHAGE: (1,2,3,4)

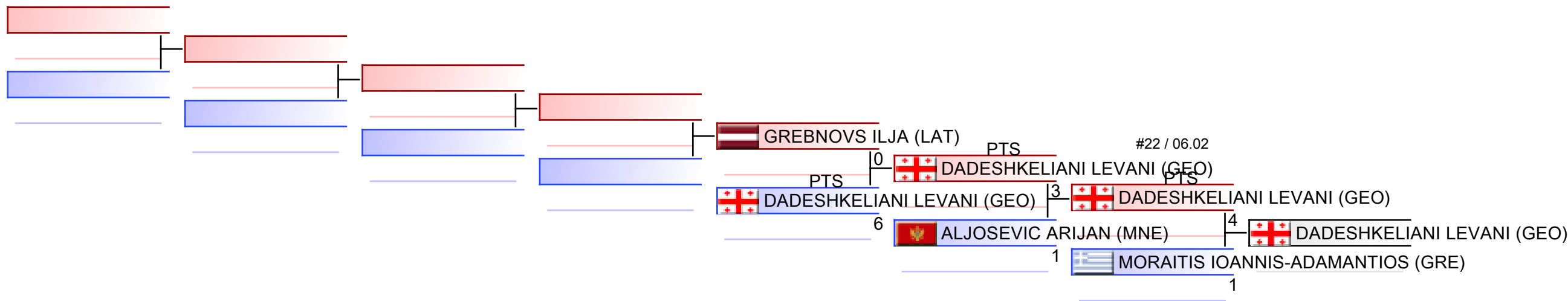

Referees:							
-----------	--	--	--	--	--	--	--



EKF Junior, Cadet & U21 Championships
2026 - Limassol - 2026-02-06



Official Results

Cadet Kumite Male -52 kg			
1	DOROSH MARK		UKR - UKRAINE
2	CAFISO EDOARDO		ITA - ITALY
3	DADESHKELIANI LEVANI		GEO - GEORGIA
3	HASANI NEEVIS		ALB - ALBANIA
5	MORAITIS IOANNIS-ADAMANTIOS		GRE - GREECE
5	LOPEZ PEREZ HUGO		ESP - SPAIN
7	ALJOSEVIC ARIJAN		MNE - MONTENEGRO
7	MEMEDI MERVAN		MKD - NORTH MACEDONIA
9	GREBNOVS ILJA		LAT - LATVIA
9	FICHELTMANN ERIC		GER - GERMANY
11	MARCINEK MAXIM		SVK - SLOVAKIA

CADET KUMITE MALE -57 KG



EKF Junior, Cadet & U21 Championships 2026 - Lim..

ENTRIES BY WEIGHT CATEGORY



Cadet Kumite Male -57 kg

As of 8 FEB 2026

Code	ID	Gender	Name	Seeding
ALB	ALB02388	M	TOZAJ TOZO	
ARM	ARM003270	M	KARAPETYAN ARAM	
AZE	AZE03023	M	GOZALOV AMIN	
BEL	BEL003451	M	MEHADHEBI AMIR	
BIH	BIH03720	M	GENJGA SADZID	
BUL	BUL003048	M	TANEV IOAN	
CRO	CRO03709	M	CORDASEV TOMISLAV	
CYP	CYP003239	M	PAFITIS CHRISTOS	
CZE	CZE02713	M	SPANIK TOBIAS	2
ENG	ENG003608	M	GORDON-SCOTT ANTON	
ESP	ESP004299	M	ARRIBAS JIMENEZ OSCAR	
EST	EST002778	M	HALJAS ADRIAN	
FRA	FRA004318	M	DEBERDT MAHE	4
GEO		M	TSULAIA NIKOLOZI	
GER	GER004278	M	MORINA ARTION	
GRE	GRE004267	M	STAVRIDIS DIMITRIOS	
IRL	IRL003175	M	OBRIEN JACE	
ISR	ISR02932	M	VERCHILOVSKY LIAM	
ITA	ITA005926	M	GIULIANI ACHILLE	
LAT	LAT003159	M	PUMPURS ANDREJS	
MDA	MDA02379	M	VOLEANSCHI ARSENI	
NED	NED003425	M	BOHOUDI ILYAS	1
POL	POL10977	M	ZGOLA BARTOSZ	
POR	POR003559	M	GARRUCHO SIMAO	
ROU	ROU03605	M	DUMITRU MIRCEA ANDREI	
SRB	SRB03733	M	POPOVIC JOVAN	
SVK	SVK003403	M	KOVACIK SIMON	3
SWE	SWE003399	M	DAOUD ADAM	
UKR	UKR003923	M	SHEVCHENKO STANISLAV	
WKF-1	WKF-1006807	M	SOKOLOV KIRILL	

Cadet Kumite Male -57 kg

EKF Junior, Cadet & U21 Championships 2026 - Limassol, Spyros Kyprianou Athletic Center, Limassol, CYP

2026-02-06

Tatami
3 14:40

Pool
1/4



WKF
EUROPE

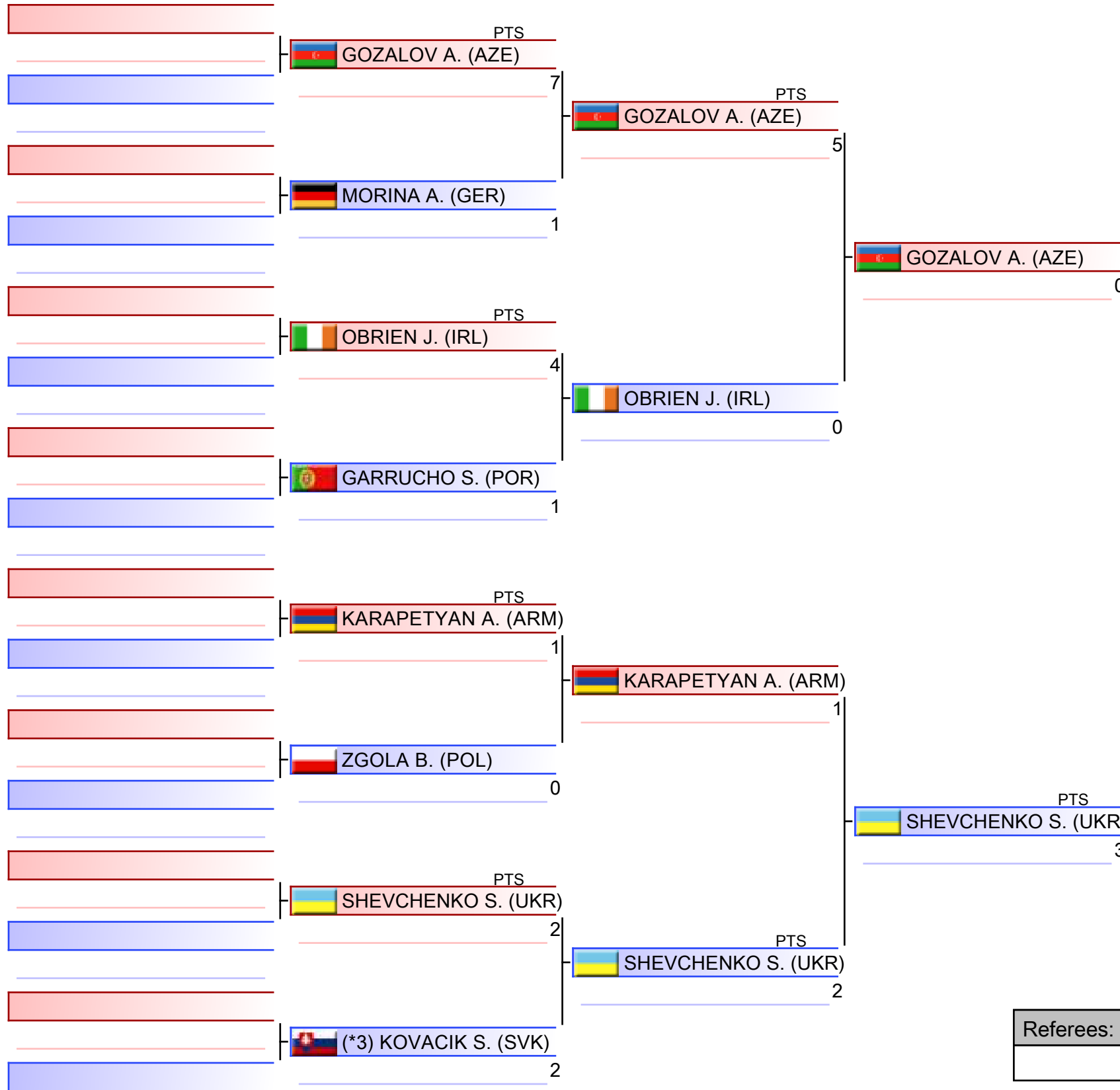

SHEVCHENKO S. (UKR)

1. TANEV IOAN (BUL)
2. GIULIANI ACHILLE (ITA)
3. ARRIBAS JIMENEZ OSCAR (ESP)
3. PUMPURS ANDREJS (LAT)
5. SHEVCHENKO STANISLAV (UKR)
5. STAVRIDIS DIMITRIOS (GRE)
7. SPANIK TOBIAS (CZE)
7. BOHOUDI ILYAS (NED)

*Seeded

Referees:			

Cadet Kumite Male -57 kg

EKF Junior, Cadet & U21 Championships 2026 - Limassol, Spyros Kyprianou Athletic Center, Limassol, CYP

2026-02-06

Tatami
3 15:20

Pool
2/4



WKF
EUROPE

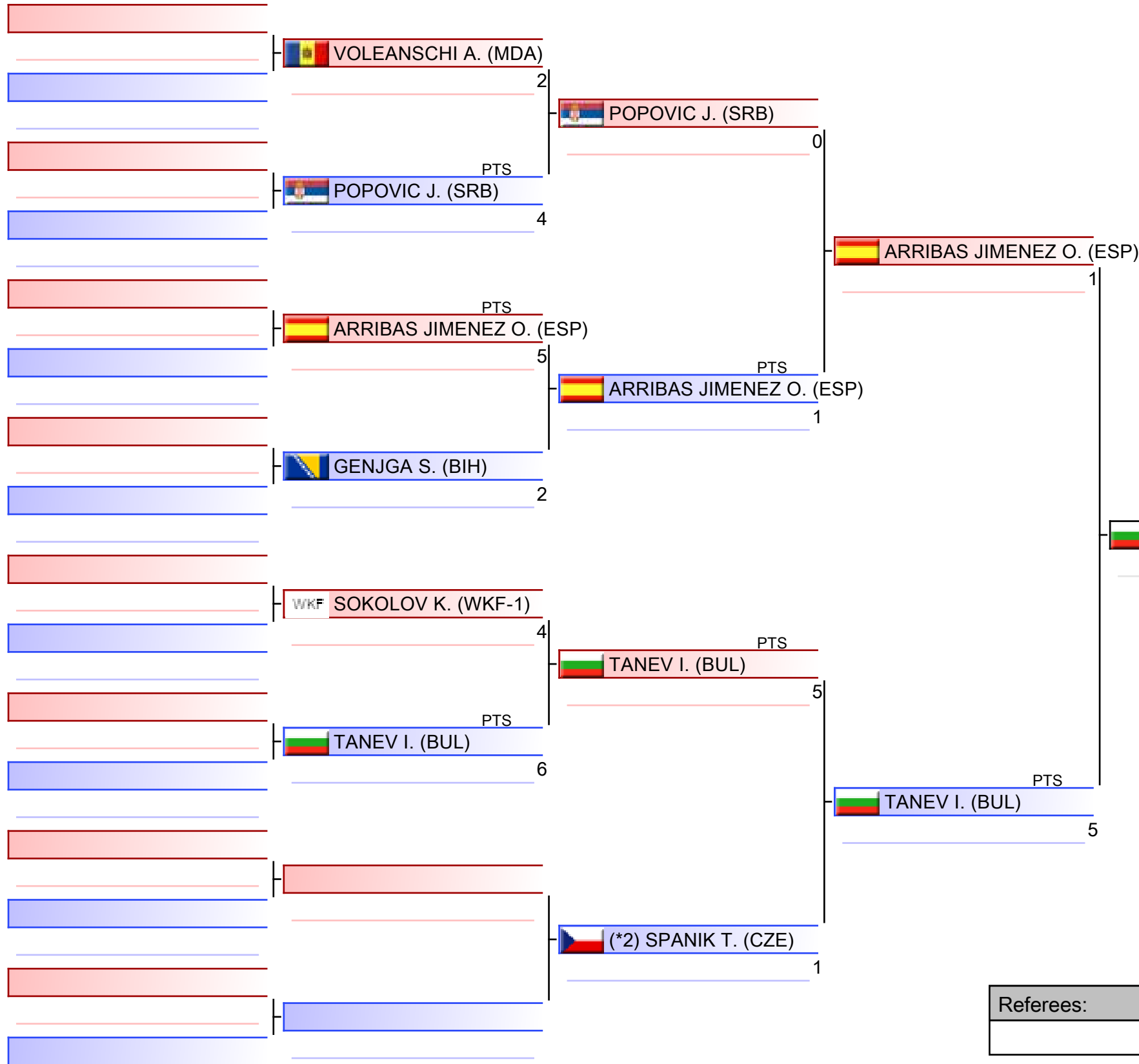

TANEV I. (BUL)

1. TANEV IOAN (BUL)
2. GIULIANI ACHILLE (ITA)
3. ARRIBAS JIMENEZ OSCAR (ESP)
3. PUMPURS ANDREJS (LAT)
5. SHEVCHENKO STANISLAV (UKR)
5. STAVRIDIS DIMITRIOS (GRE)
7. SPANIK TOBIAS (CZE)
7. BOHOUDI ILYAS (NED)

*Seeded

Referees:			

Cadet Kumite Male -57 kg

EKF Junior, Cadet & U21 Championships 2026 - Limassol, Spyros Kyprianou Athletic Center, Limassol, CYP

2026-02-06

Tatami
4 14:40

Pool
3/4

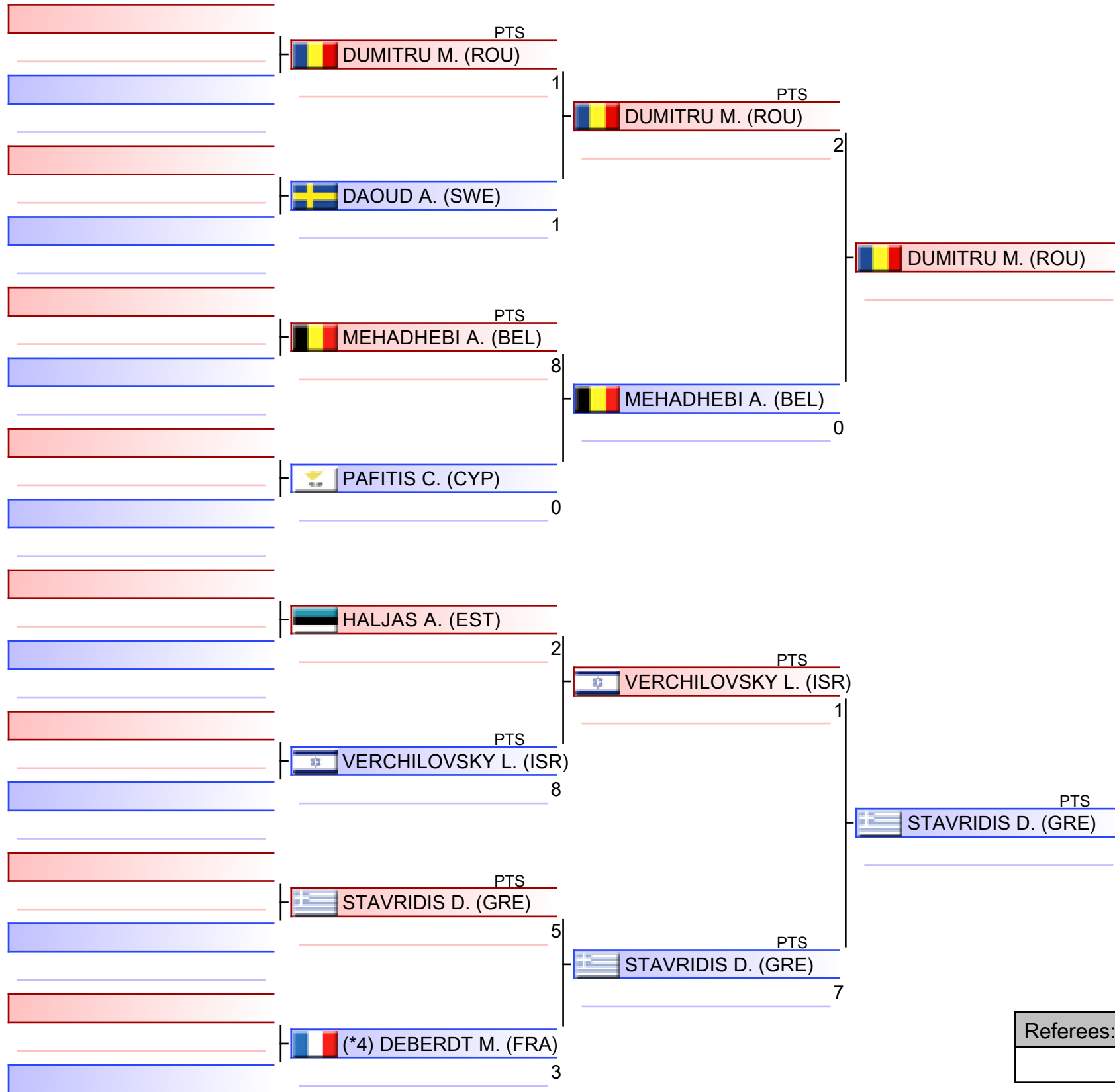

WKF
EUROPE

STAVRIDIS D. (GRE)

1. TANEV IOAN (BUL)
2. GIULIANI ACHILLE (ITA)
3. ARRIBAS JIMENEZ OSCAR (ESP)
3. PUMPURS ANDREJS (LAT)
5. SHEVCHENKO STANISLAV (UKR)
5. STAVRIDIS DIMITRIOS (GRE)
7. SPANIK TOBIAS (CZE)
7. BOHOUDI ILYAS (NED)

*Seeded

Referees:			

Cadet Kumite Male -57 kg

EKF Junior, Cadet & U21 Championships 2026 - Limassol, Spyros Kyprianou Athletic Center, Limassol, CYP

2026-02-06

Tatami
4 15:20

Pool
4/4

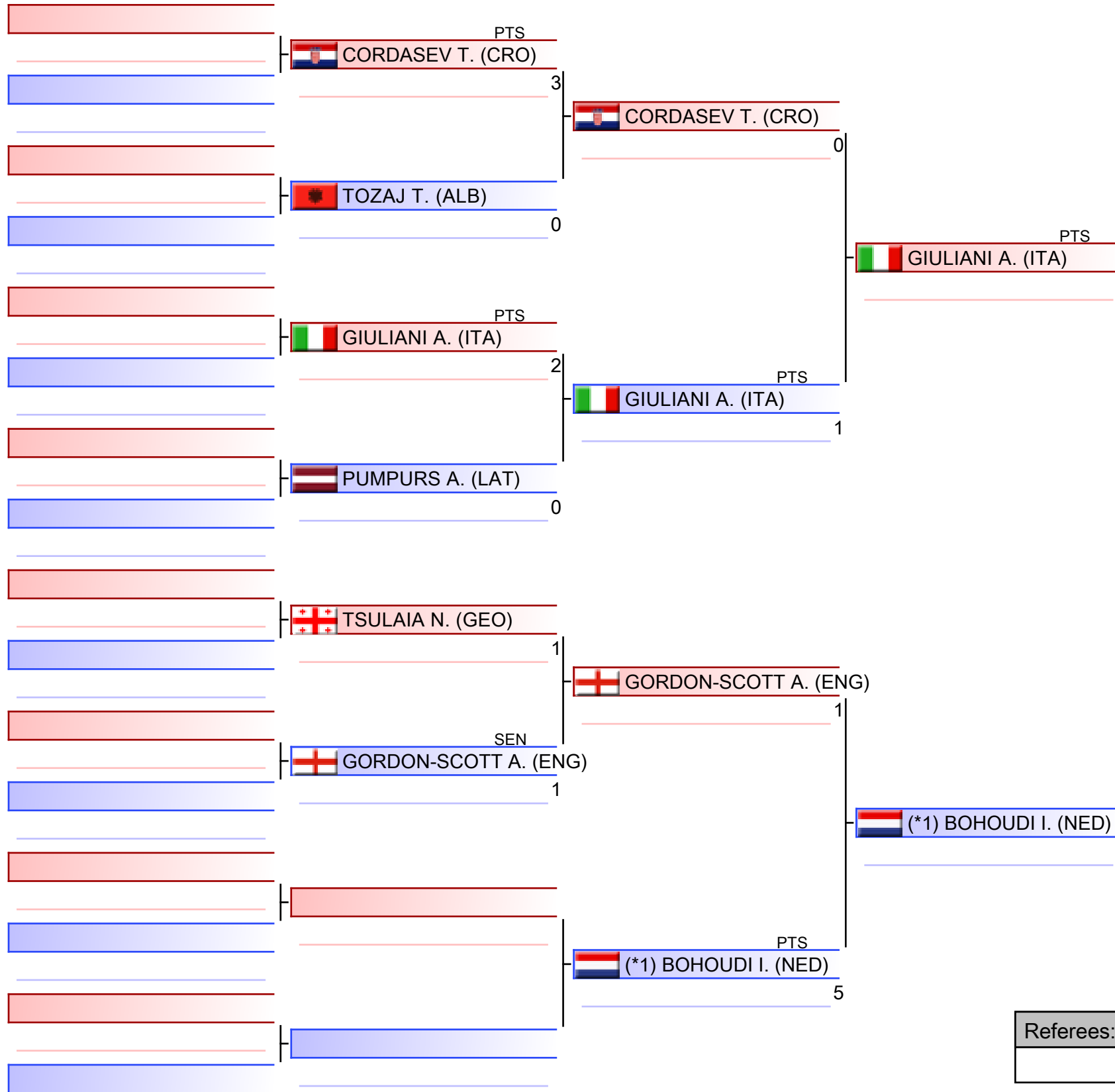

WKF
EUROPE

1. TANEV IOAN (BUL)
2. GIULIANI ACHILLE (ITA)
3. ARRIBAS JIMENEZ OSCAR (ESP)
3. PUMPURS ANDREJS (LAT)
5. SHEVCHENKO STANISLAV (UKR)
5. STAVRIDIS DIMITRIOS (GRE)
7. SPANIK TOBIAS (CZE)
7. BOHOUDI ILYAS (NED)

*Seeded

Referees:			

Pool winner-Cadet Kumite Male -57 kg

EKF Junior, Cadet & U21 Championships 2026 - Limassol, Spyros Kyprianou Athletic Center, Limassol, CYP

2026-02-06

Tatami
3 15:55

Pool
1/1



WKF
EUROPE

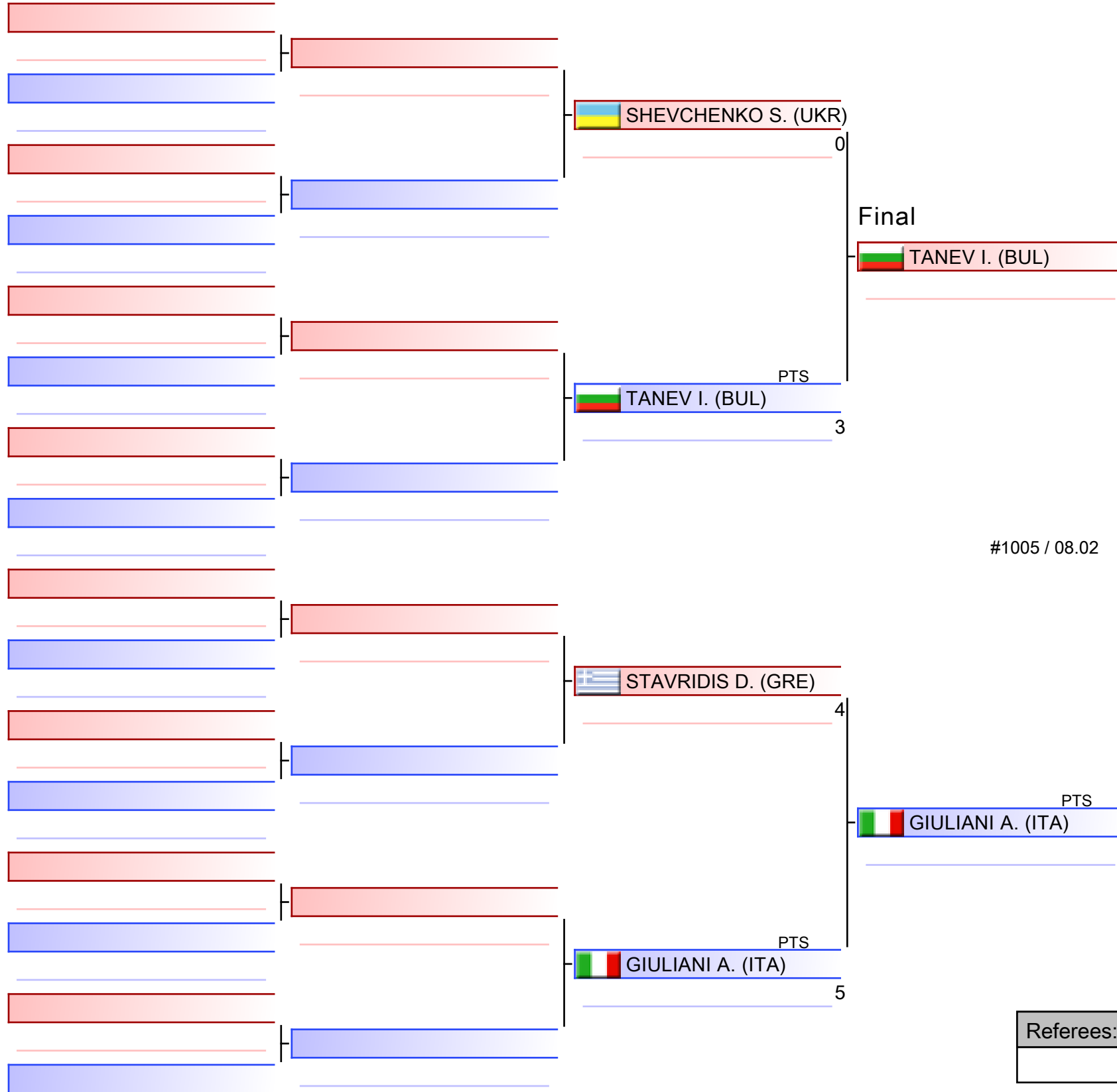

1. TANEV IOAN (BUL)
2. GIULIANI ACHILLE (ITA)
3. ARRIBAS JIMENEZ OSCAR (ESP)
3. PUMPURS ANDREJS (LAT)
5. SHEVCHENKO STANISLAV (UKR)
5. STAVRIDIS DIMITRIOS (GRE)
7. SPANIK TOBIAS (CZE)
7. BOHOUDI ILYAS (NED)

*Seeded

Referees:			

Cadet Kumite Male -57 kg

EKF Junior, Cadet & U21 Championships 2026 - Limassol

2026-02-06

Tatami
4 16:00

Pool
1,2,3,4

(c)sportdata GmbH & Co KG 2000-2026 (2026-02-08 17:46) v 11.0.0 build 2 (2025-01-21 11:49 CET) License: SDIL TWG2025 (expire 2026-09-30)

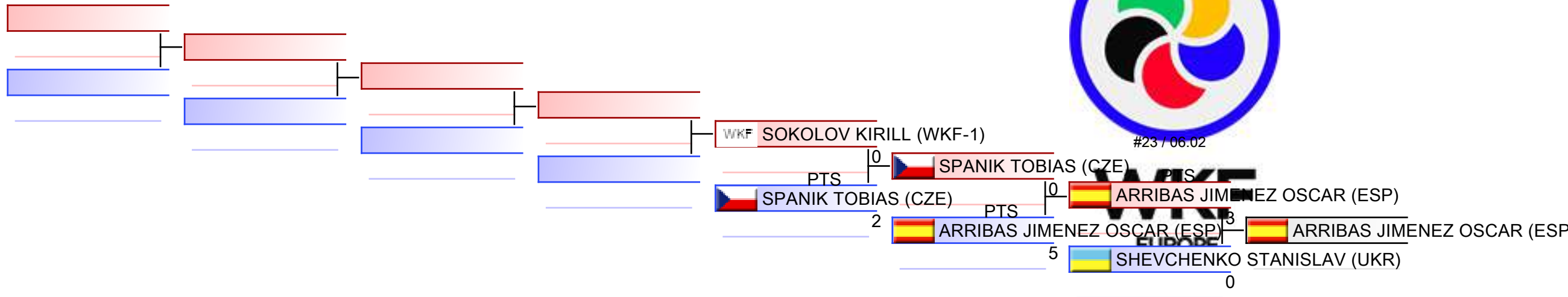

REPECHAGE: (1,2,3,4)

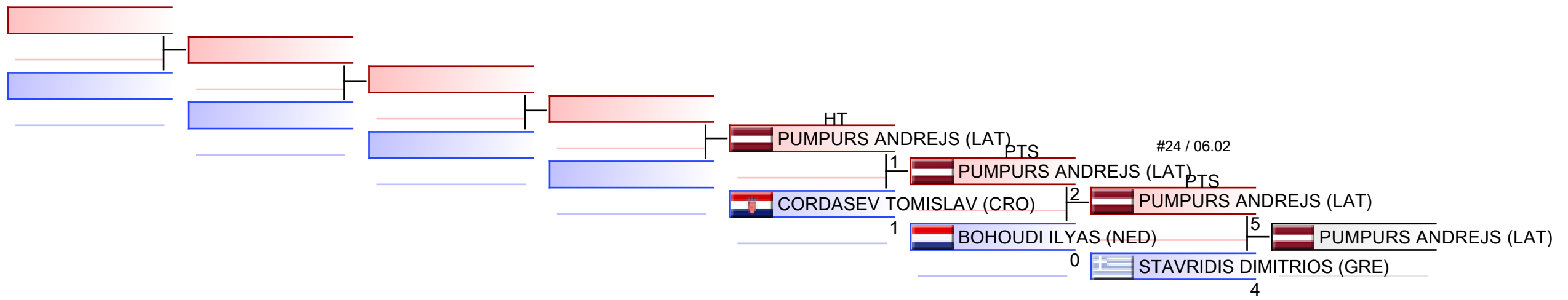

Referees:							
-----------	--	--	--	--	--	--	--



EKF Junior, Cadet & U21 Championships
2026 - Limassol - 2026-02-06



Official Results

Cadet Kumite Male -57 kg			
1	TANEV IOAN		BUL - BULGARIA
2	GIULIANI ACHILLE		ITA - ITALY
3	ARRIBAS JIMENEZ OSCAR		ESP - SPAIN
3	PUMPURS ANDREJS		LAT - LATVIA
5	SHEVCHENKO STANISLAV		UKR - UKRAINE
5	STAVRIDIS DIMITRIOS		GRE - GREECE
7	SPANIK TOBIAS		CZE - CZECH REPUBLIC
7	BOHOUDI ILYAS		NED - NETHERLANDS
9	SOKOLOV KIRILL		WKF-1 - WKF-1
9	CORDASEV TOMISLAV		CRO - CROATIA

CADET KUMITE MALE -63 KG



EKF Junior, Cadet & U21 Championships 2026 - Lim..



ENTRIES BY WEIGHT CATEGORY

Cadet Kumite Male -63 kg

As of 8 FEB 2026

Code	ID	Gender	Name	Seeding
ARM	ARM003271	M	MUSHEGHYAN GOR	
AUT	AUT003121	M	SCHNETZER ERIC	
BIH	BIH004819	M	HADZIC OMER	
BUL	BUL003186	M	GEORGIEV ADRIAN	
CRO	CRO03456	M	KOMARAC FILIP	3
CYP	CYP003282	M	CHI ADAMOS	
DEN	DEN003044	M	EMINOVSKI SEMIH	
ESP	ESP03599	M	GARCIA DE BLAS REDONDO RODRIGO	2
FRA	FRA004509	M	THOZE EMEN MATTHEW	
GER	GER004224	M	MARTIN MAXIMILIAN	
GRE	GRE03456	M	LENOS DIMITRIOS	
HUN	HUN003520	M	BAGI ADAM	
IRL	IRL003210	M	CERKASINS TIMUR	
ISR	ISR02931	M	KIRNOV ANDREY	
ITA	ITA005691	M	BALDASSARRE RAFFAELE	1
LAT	LAT003015	M	OZEROVS ARTJOMS	
LTU	LTU002589	M	KAZIUKAITIS PRANAS	
MDA	MDA02382	M	VOLEANSCHI AKIM	
MKD	MKD03023	M	DZORLEV MARKO	4
MNE	MNE02994	M	DJURIC LUKA	
NED	NED003352	M	KHARMICH ADAM	
POL	POL2804	M	BUDNY SZYMON	
POR	POR003488	M	MORAIS PEDRO	
ROU	ROU03613	M	BUICA MATEI CRISTIAN	
SRB	SRB03382	M	MARKOVIC VUK	
SUI	SUI004975	M	TIEFENAUER JONATHAN	
SVK	SVK003249	M	KOVAL DAVID	
SWE	SWE003401	M	ANDERSSON EMIL	
UKR	UKR003914	M	REPCHUK ANDRII	
WKF-1	WKF-1006797	M	ALMEKHAMETOV EMIL	

Cadet Kumite Male -63 kg

EKF Junior, Cadet & U21 Championships 2026 - Limassol, Spyros Kyprianou Athletic Center, Limassol, CYP

2026-02-06

Tatami
5 14:35

Pool
1/4



WKF
EUROPE

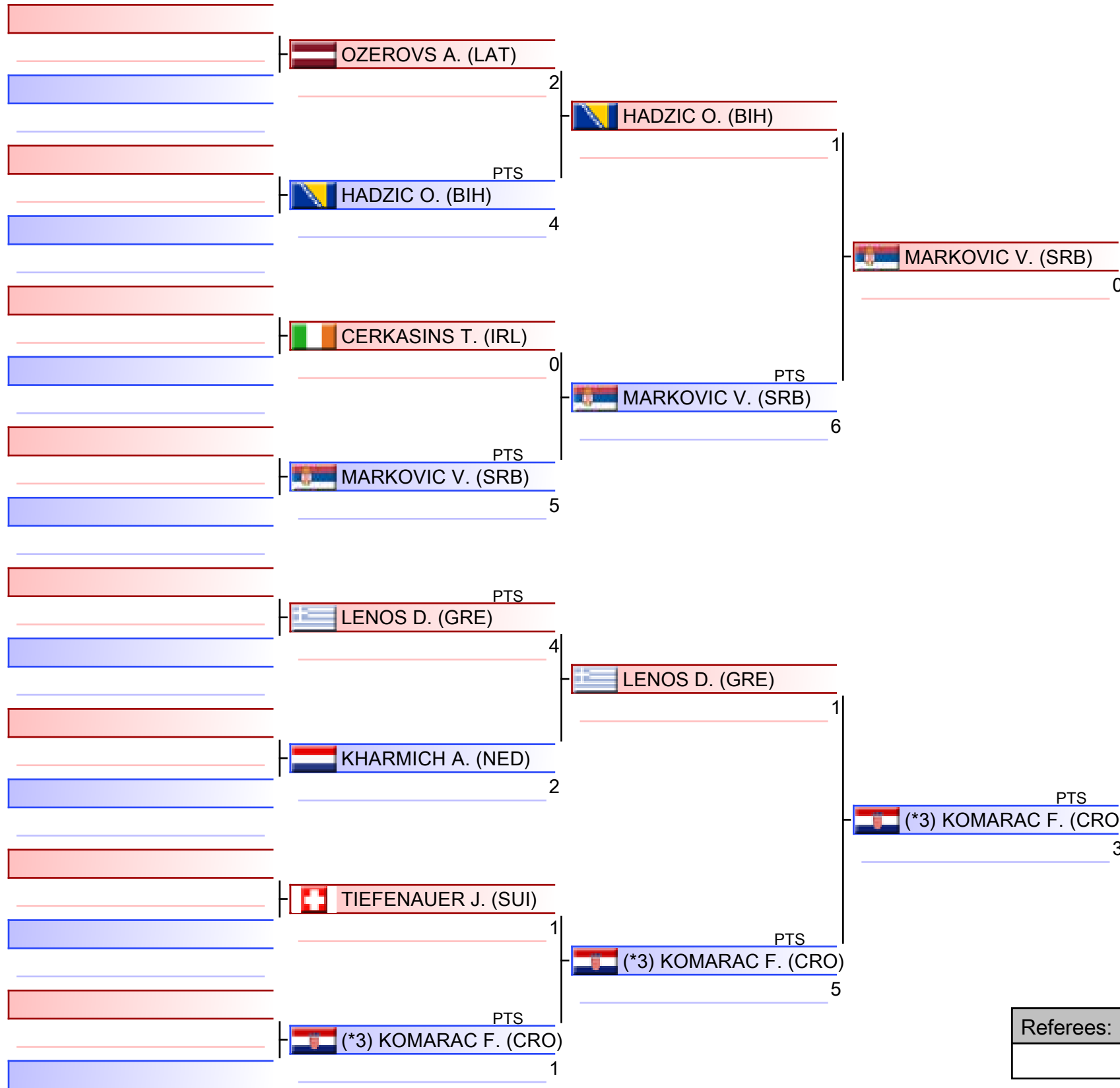

(*3) KOMARAC F. (CRO)

1. BALDASSARRE RAFFAELE (ITA)
2. ALMEKHAMETOV EMIL (WKF-1)
3. BUDNY SZYMON (POL)
3. KOVAL DAVID (SVK)
5. KOMARAC FILIP (CRO)
5. DZORLEV MARKO (MKD)
7. GARCIA DE BLAS REDONDO RODRIGO (ESP)
7. MARTIN MAXIMILIAN (GER)

*Seeded

Referees:			

Cadet Kumite Male -63 kg

EKF Junior, Cadet & U21 Championships 2026 - Limassol, Spyros Kyprianou Athletic Center, Limassol, CYP

2026-02-06

Tatami
5 15:15

Pool
2/4



WKF
EUROPE

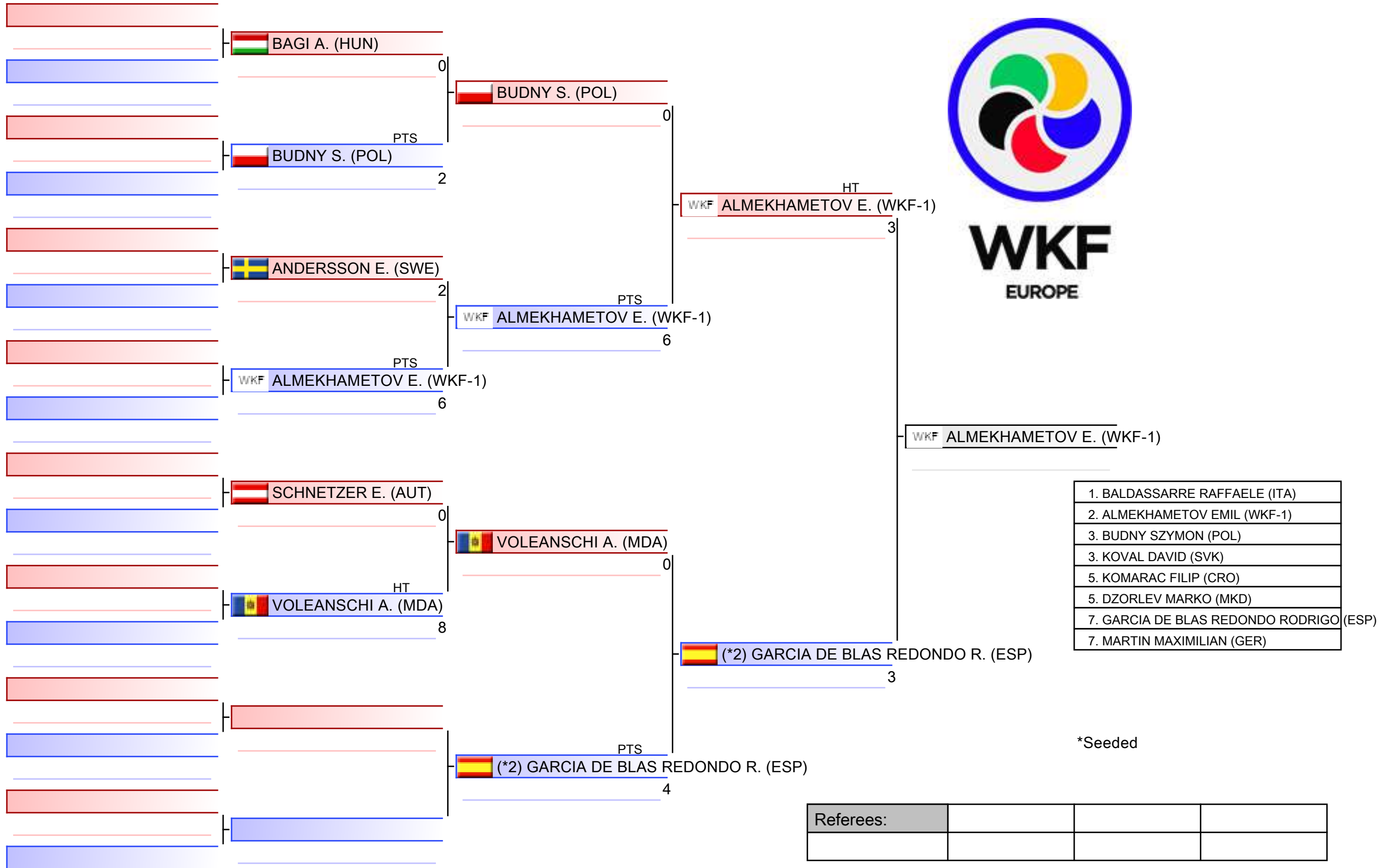

Cadet Kumite Male -63 kg

EKF Junior, Cadet & U21 Championships 2026 - Limassol, Spyros Kyprianou Athletic Center, Limassol, CYP

2026-02-06

Tatami
6 14:35

Pool
3/4



WKF
EUROPE

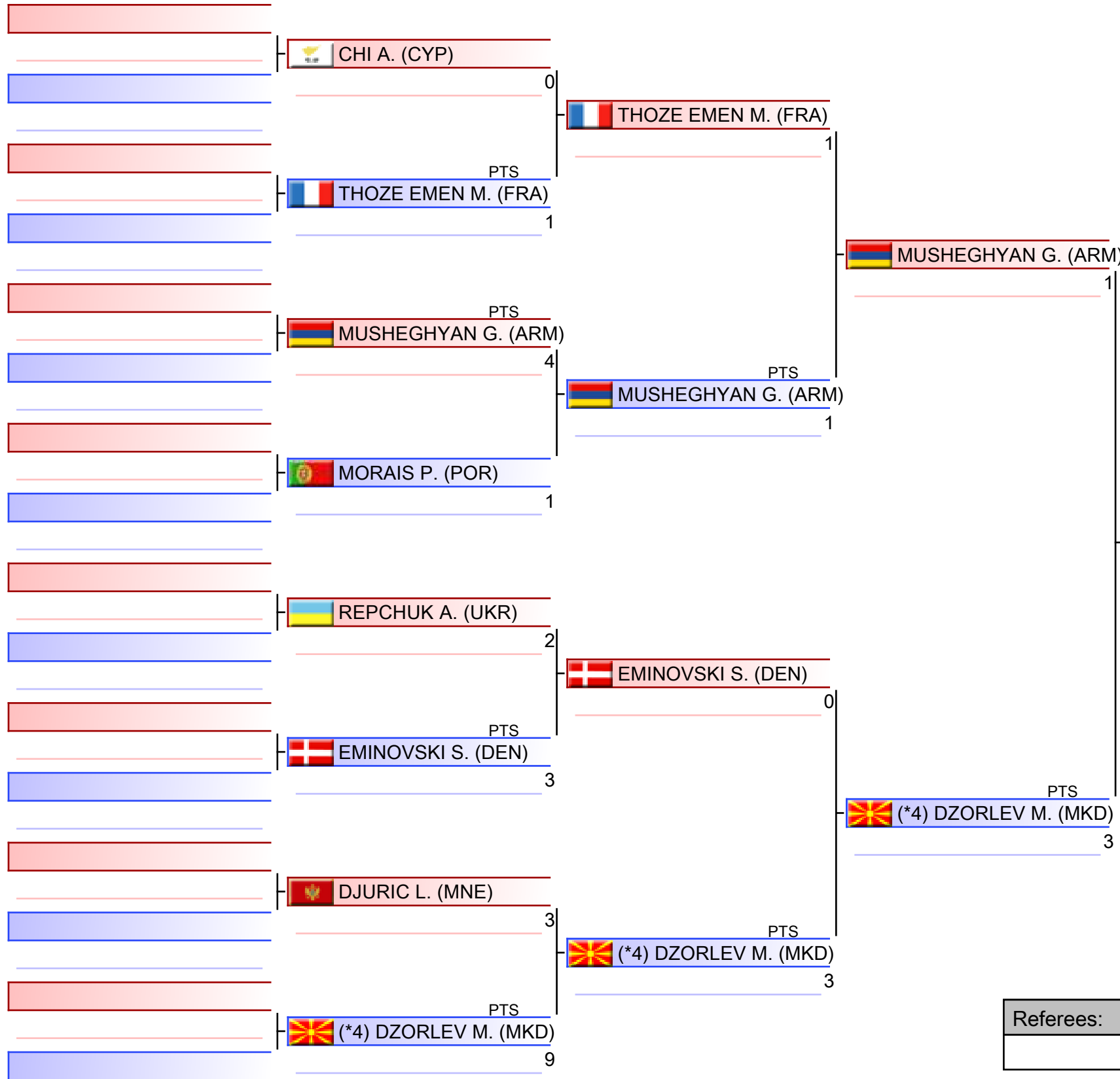

(*4) DZORLEV M. (MKD)

1. BALDASSARRE RAFFAELE (ITA)
2. ALMEKHAMETOV EMIL (WKF-1)
3. BUDNY SZYMON (POL)
3. KOVAL DAVID (SVK)
5. KOMARAC FILIP (CRO)
5. DZORLEV MARKO (MKD)
7. GARCIA DE BLAS REDONDO RODRIGO (ESP)
7. MARTIN MAXIMILIAN (GER)

*Seeded

Referees:			

Cadet Kumite Male -63 kg

EKF Junior, Cadet & U21 Championships 2026 - Limassol, Spyros Kyprianou Athletic Center, Limassol, CYP

2026-02-06

Tatami
6 15:15

Pool
4/4



WKF
EUROPE

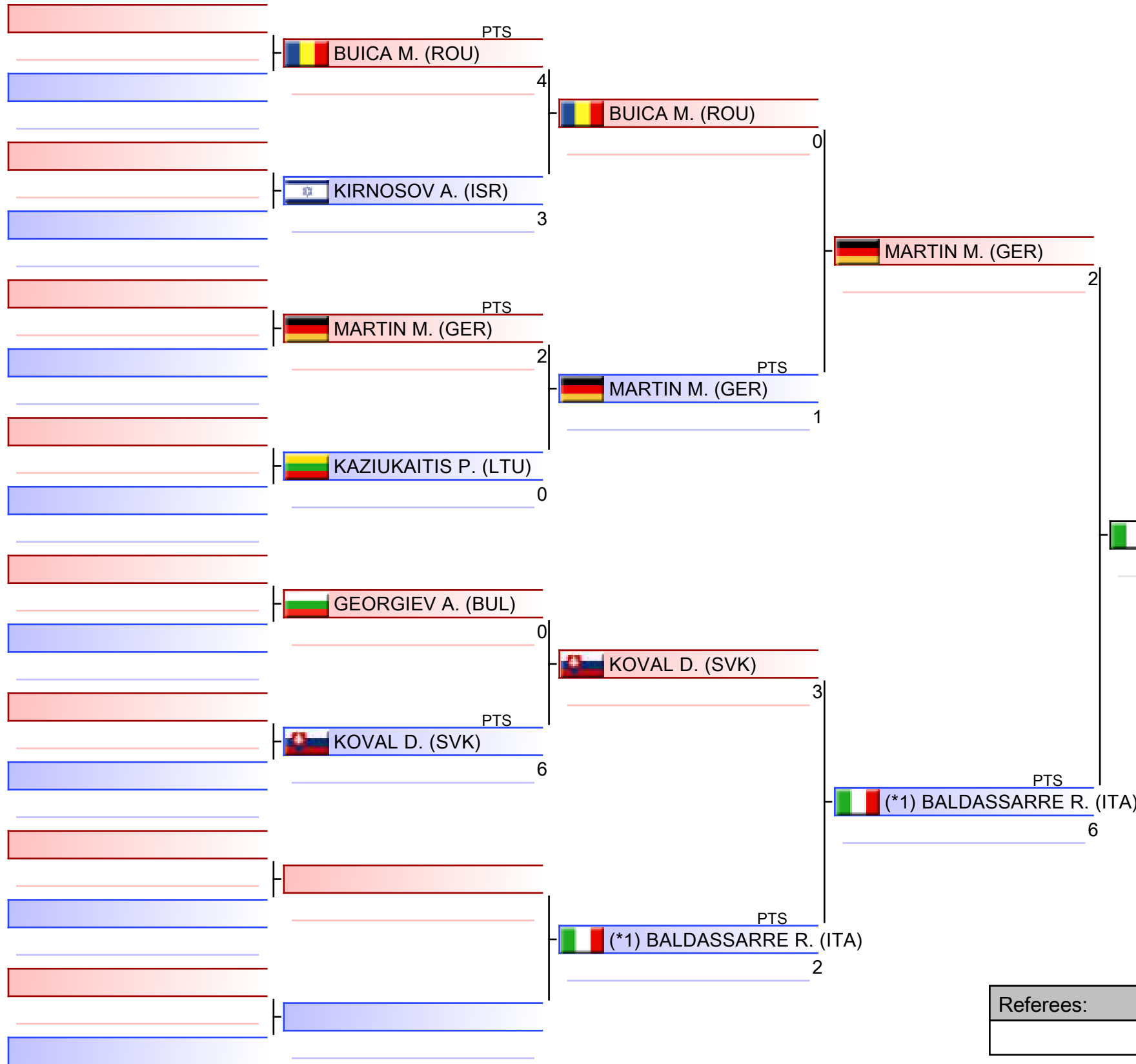

(*1) BALDASSARRE R. (ITA)

1. BALDASSARRE RAFFAELE (ITA)
2. ALMEKHAMETOV EMIL (WKF-1)
3. BUDNY SZYMON (POL)
3. KOVAL DAVID (SVK)
5. KOMARAC FILIP (CRO)
5. DZORLEV MARKO (MKD)
7. GARCIA DE BLAS REDONDO RODRIGO (ESP)
7. MARTIN MAXIMILIAN (GER)

*Seeded

Referees:			

Pool winner-Cadet Kumite Male -63 kg

EKF Junior, Cadet & U21 Championships 2026 - Limassol, Spyros Kyprianou Athletic Center, Limsassol, CYP

2026-02-06

Tatami
5 15:50

Pool
1/1



WKF
EUROPE

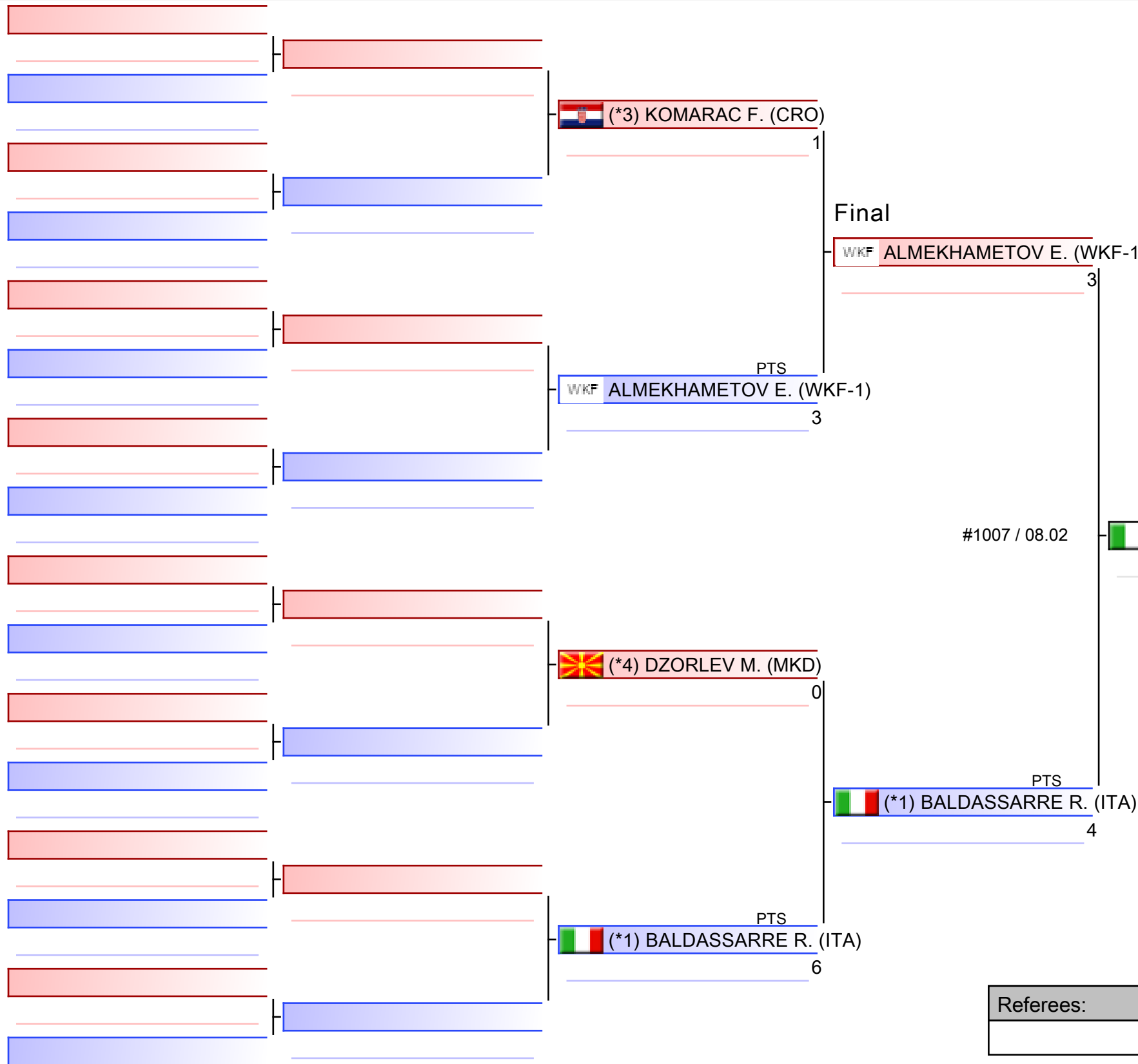

1. BALDASSARRE RAFFAELE (ITA)
2. ALMEKHAMETOV EMIL (WKF-1)
3. BUDNY SZYMON (POL)
3. KOVAL DAVID (SVK)
5. KOMARAC FILIP (CRO)
5. DZORLEV MARKO (MKD)
7. GARCIA DE BLAS REDONDO RODRIGO (ESP)
7. MARTIN MAXIMILIAN (GER)

*Seeded

Referees:			

Cadet Kumite Male -63 kg

EKF Junior, Cadet & U21 Championships 2026 - Limassol

2026-02-06

Tatami
4 16:20

Pool
1,2,3,4

(c)sportdata GmbH & Co KG 2000-2026 (2026-02-08 17:46) v 11.0.0 build 2 (2025-01-21 11:49 CET) License: SDIL TWG2025 (expire 2026-09-30)

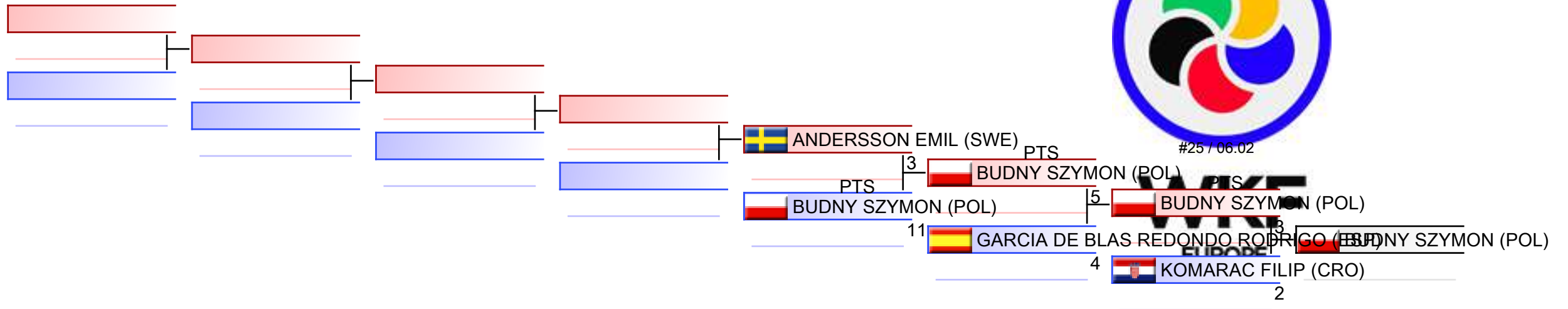

REPECHAGE: (1,2,3,4)

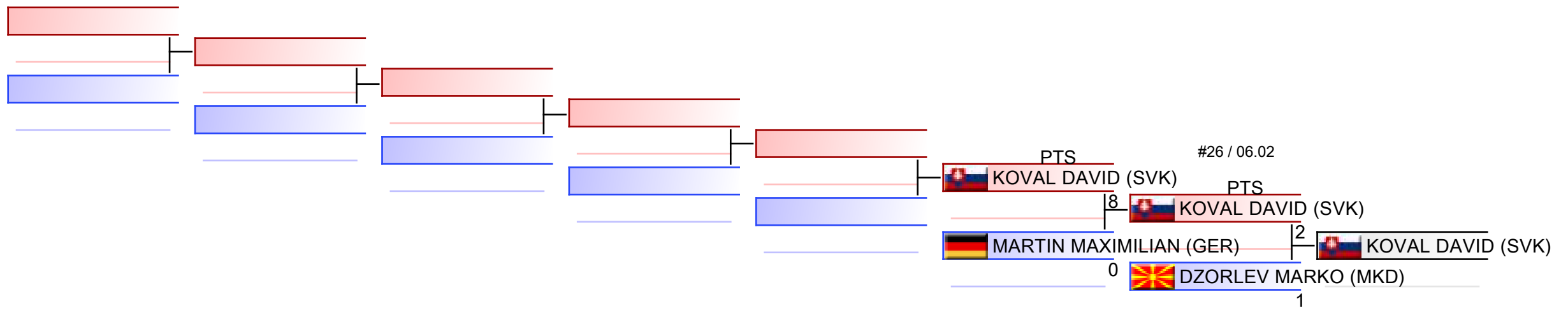

Referees:							
-----------	--	--	--	--	--	--	--



EKF Junior, Cadet & U21 Championships
2026 - Limassol - 2026-02-06



Official Results

Cadet Kumite Male -63 kg			
1	BALDASSARRE RAFFAELE		ITA - ITALY
2	ALMEKHAMETOV EMIL		WKF-1 - WKF-1
3	BUDNY SZYMON		POL - POLAND
3	KOVAL DAVID		SVK - SLOVAKIA
5	KOMARAC FILIP		CRO - CROATIA
5	DZORLEV MARKO		MKD - NORTH MACEDONIA
7	GARCIA DE BLAS REDONDO RODRIGO		ESP - SPAIN
7	MARTIN MAXIMILIAN		GER - GERMANY
9	ANDERSSON EMIL		SWE - SWEDEN

CADET KUMITE MALE -70 KG



EKF Junior, Cadet & U21 Championships 2026 - Lim..



ENTRIES BY WEIGHT CATEGORY

Cadet Kumite Male -70 kg

As of 8 FEB 2026

Code	ID	Gender	Name	Seeding
ALB	ALB02573	M	SELENICA HYSEN	
ARM	ARM003268	M	POGHOSYAN ERIK	
AZE	AZE003639	M	ALIMURADOV NURLAN	
BIH	BIH03727	M	JASAREVIC EJMEN	
BUL	BUL003142	M	MITOV ALEKSANDAR	
CRO	CRO03454	M	BERMANEC DAVID	2
CYP	CYP003220	M	NICODIMOU NEOFYTOS	
CZE	CZE02843	M	SUPKA TOBIAS	
ESP	ESP004281	M	BLANCO CASTRO MARCOS	
FIN	FIN002828	M	TAKALA ANTON	
FRA	FRA004501	M	TARZOUT ADIL YUCEF	
GEO	GEO003075	M	DEMURIA DIEGO	
GER	GER004276	M	GRAEFE LUKAS	
GRE	GRE003744	M	PSOMAS IOANNIS	
HUN	HUN03076	M	KIS MATYAS	
IRL	IRL003055	M	MCGLYNN MICHAEL	
ISR	ISR003205	M	SABA MICHAEL	
ITA	ITA005916	M	DE GREGORIO RICCARDO	4
MKD	MKD03033	M	ELMAZI ISA	1
MLT	MLT002362	M	GRECH JADEN	
MNE	MNE02873	M	RAKOCEVIC LAZAR	
NED	NED003574	M	BOHOUDI ISSAM	
POR	POR003494	M	LOPES RODRIGO	
ROU	ROU03620	M	OSTAFIE MANDRES CRISTIAN ANDREI	
SCO	SCO002733	M	BRODIE CULLEN	3
SRB	SRB004537	M	ISAK SERGEJ	
SUI	SUI004974	M	BAUMGARTNER CEBRAIL	
SVK	SVK003250	M	FOLTIN MILAN	
UKR	UKR003917	M	PETROV SERHII	
WKF-1	AIN-1006525	M	GRISHKIN EGOR	

Cadet Kumite Male -70 kg

EKF Junior, Cadet & U21 Championships 2026 - Limassol, Spyros Kyprianou Athletic Center, Limassol, CYP

2026-02-06

Tatami
7 14:25

Pool
1/4

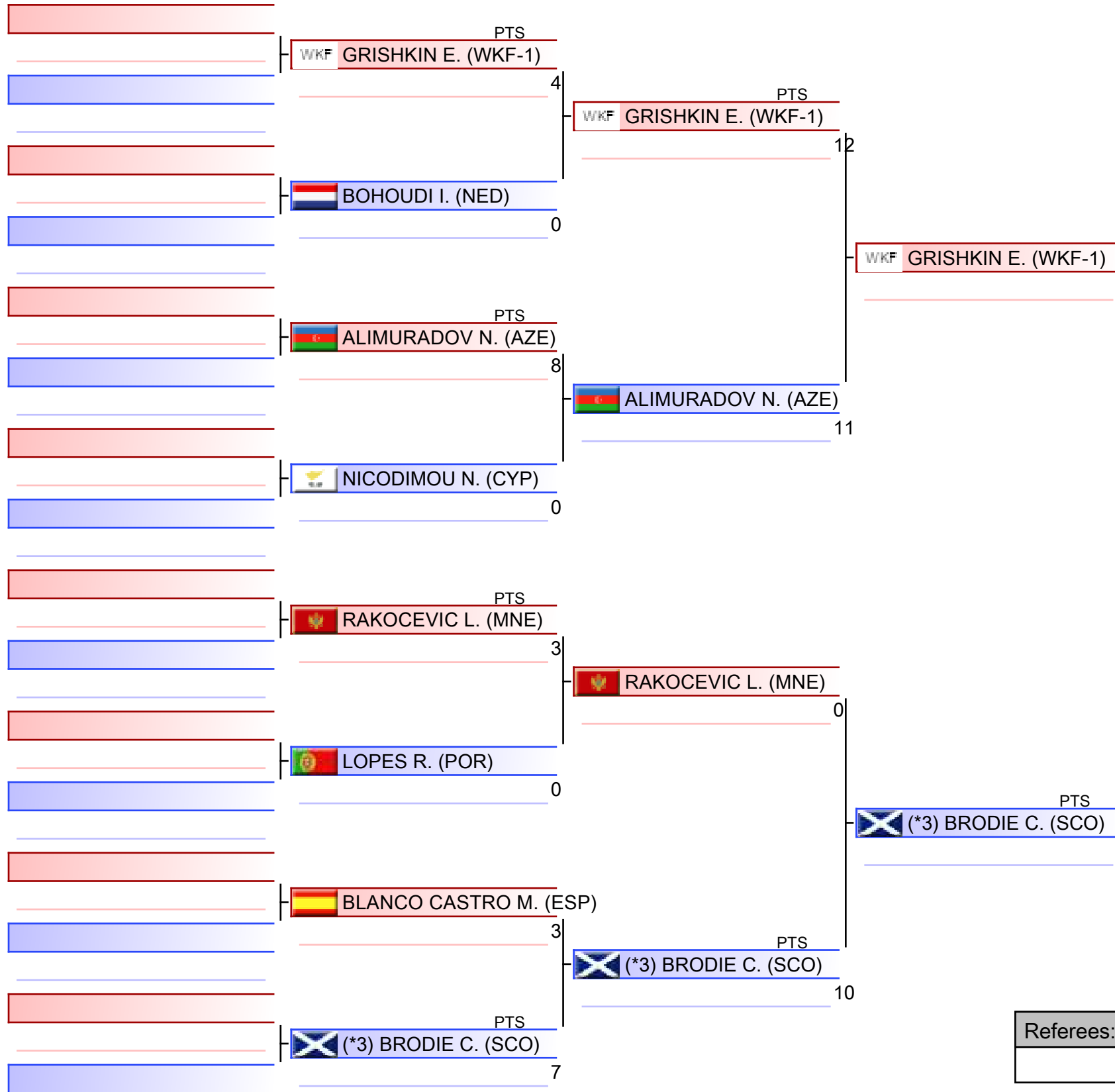

(*3) BRODIE C. (SCO)

1. BRODIE CULLEN (SCO)
2. DE GREGORIO RICCARDO (ITA)
3. GRISHKIN EGOR (WKF-1)
3. PSOMAS IOANNIS (GRE)
5. BERMANEC DAVID (CRO)
5. BAUMGARTNER CEBRAIL (SUI)
7. RAKOCEVIC LAZAR (MNE)
7. TAKALA ANTON (FIN)

*Seeded

Referees:			

Cadet Kumite Male -70 kg

EKF Junior, Cadet & U21 Championships 2026 - Limassol, Spyros Kyprianou Athletic Center, Limassol, CYP

2026-02-06

Tatami
7 15:05

Pool
2/4



WKF
EUROPE

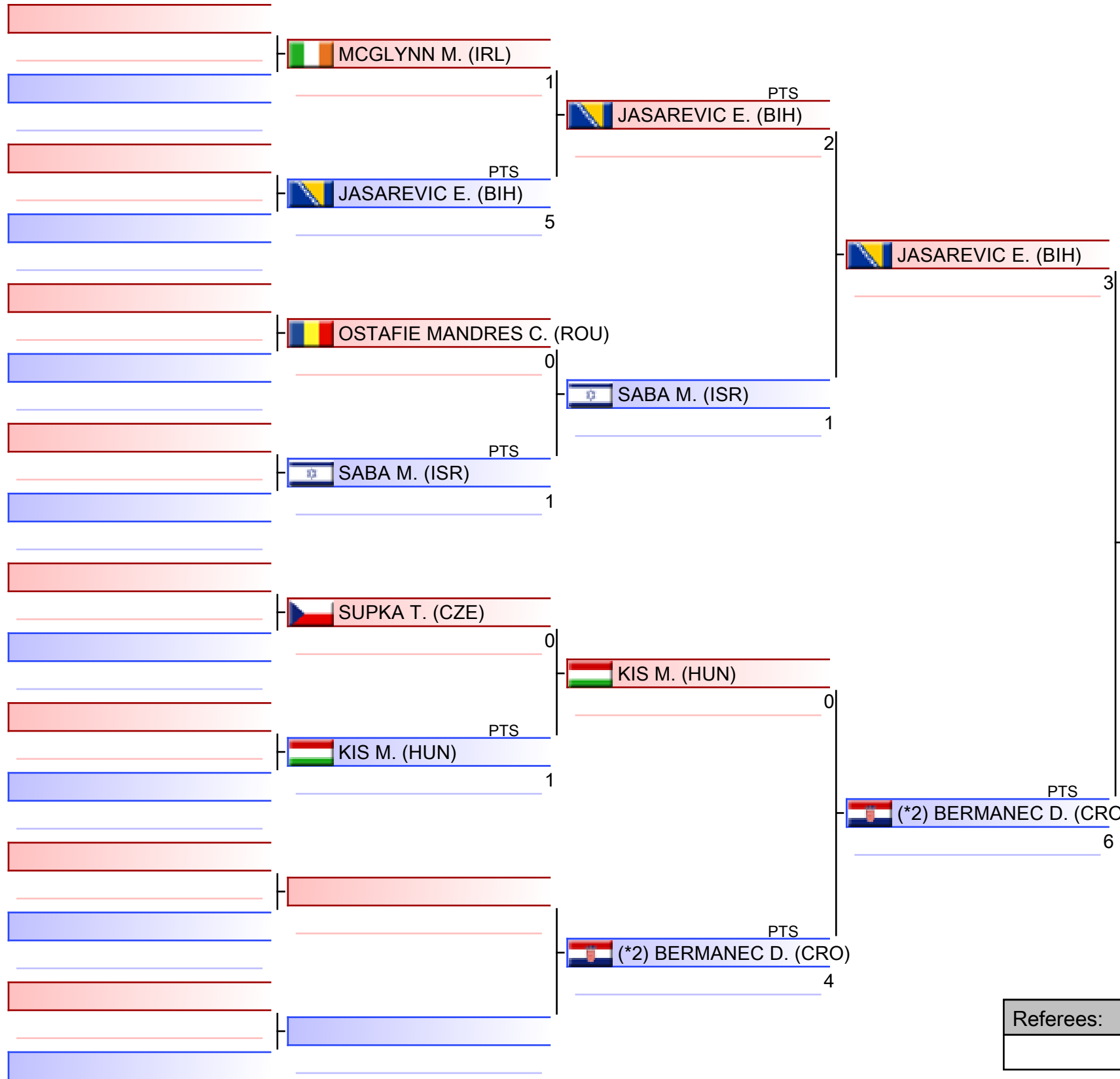

(*2) BERMANEC D. (CRO)

1. BRODIE CULLEN (SCO)
2. DE GREGORIO RICCARDO (ITA)
3. GRISHKIN EGOR (WKF-1)
3. PSOMAS IOANNIS (GRE)
5. BERMANEC DAVID (CRO)
5. BAUMGARTNER CEBRAIL (SUI)
7. RAKOCEVIC LAZAR (MNE)
7. TAKALA ANTON (FIN)

*Seeded

Referees:			

Cadet Kumite Male -70 kg

EKF Junior, Cadet & U21 Championships 2026 - Limassol, Spyros Kyprianou Athletic Center, Limassol, CYP

2026-02-06

Tatami
8 14:25

Pool
3/4



WKF
EUROPE

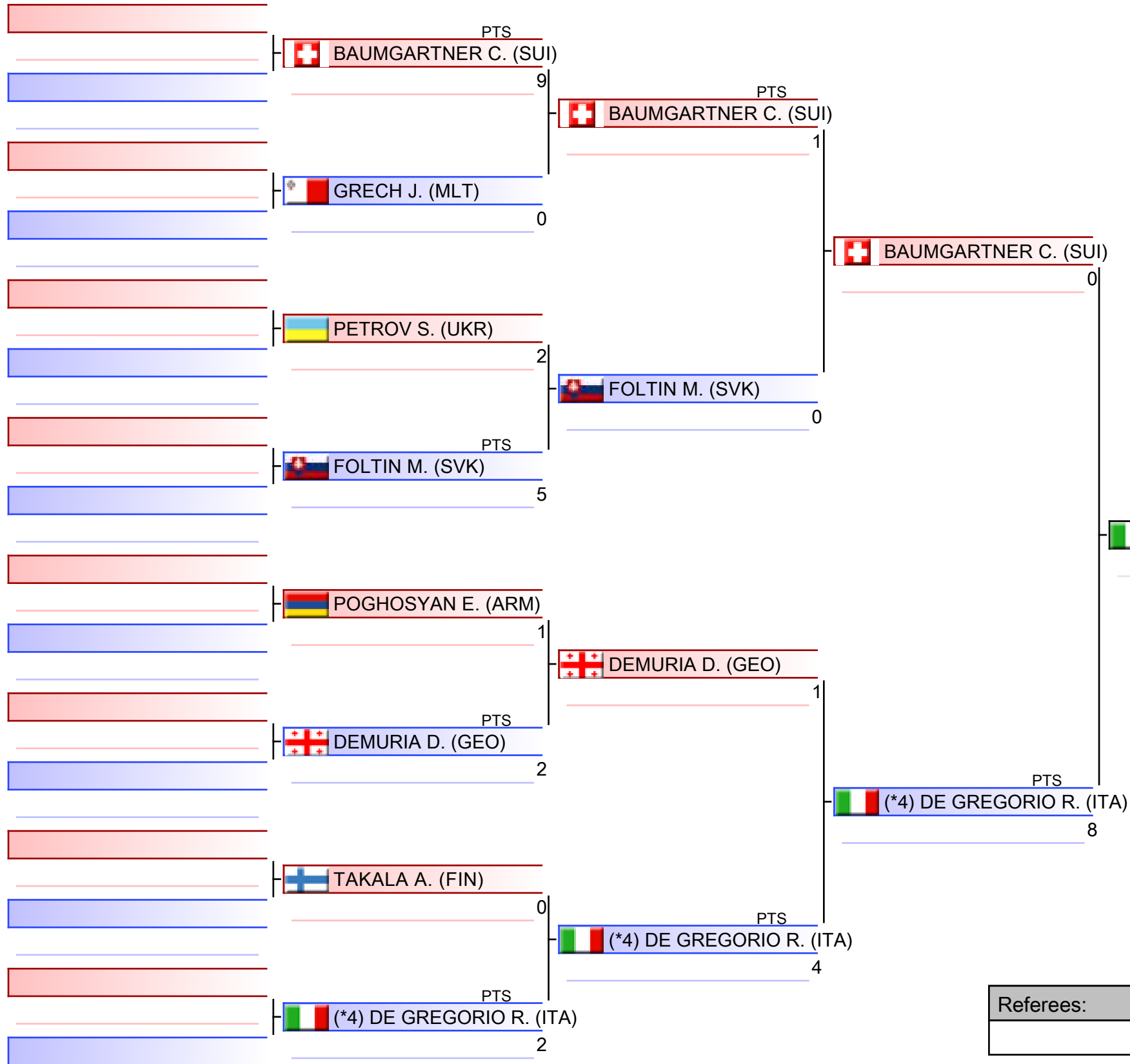

(*4) DE GREGORIO R. (ITA)

1. BRODIE CULLEN (SCO)
2. DE GREGORIO RICCARDO (ITA)
3. GRISHKIN EGOR (WKF-1)
3. PSOMAS IOANNIS (GRE)
5. BERMANEC DAVID (CRO)
5. BAUMGARTNER CEBRAIL (SUI)
7. RAKOCEVIC LAZAR (MNE)
7. TAKALA ANTON (FIN)

*Seeded

Referees:			

Cadet Kumite Male -70 kg

EKF Junior, Cadet & U21 Championships 2026 - Limassol, Spyros Kyprianou Athletic Center, Limassol, CYP

2026-02-06

Tatami
8 15:05

Pool
4/4



WKF
EUROPE

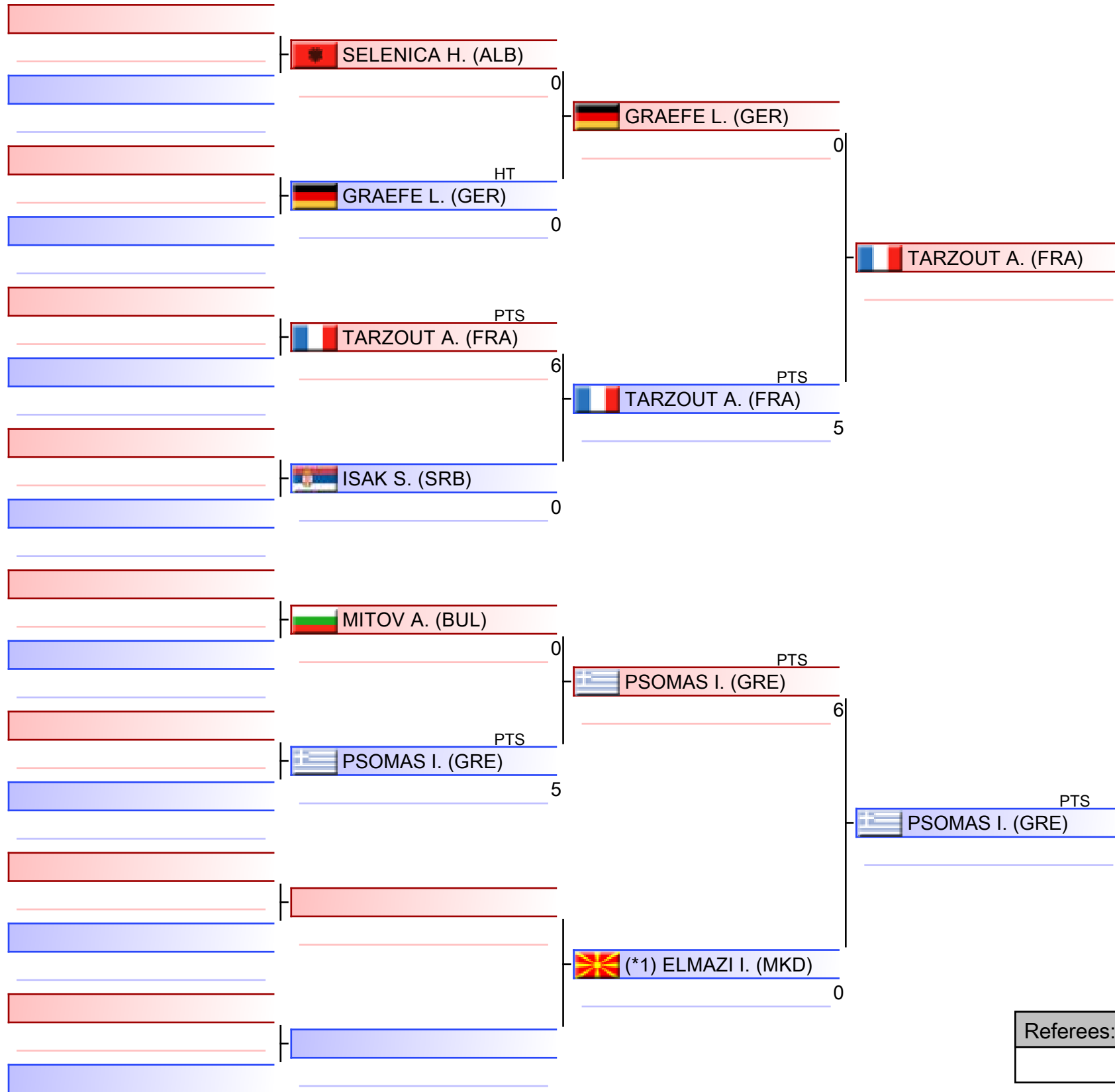

PSOMAS I. (GRE)

1. BRODIE CULLEN (SCO)
2. DE GREGORIO RICCARDO (ITA)
3. GRISHKIN EGOR (WKF-1)
3. PSOMAS IOANNIS (GRE)
5. BERMANEC DAVID (CRO)
5. BAUMGARTNER CEBRAIL (SUI)
7. RAKOCEVIC LAZAR (MNE)
7. TAKALA ANTON (FIN)

*Seeded

Referees:			

Pool winner-Cadet Kumite Male -70 kg

EKF Junior, Cadet & U21 Championships 2026 - Limassol, Spyros Kyprianou Athletic Center, Limsassol, CYP

2026-02-06

Tatami
7 15:40

Pool
1/1



WKF
EUROPE

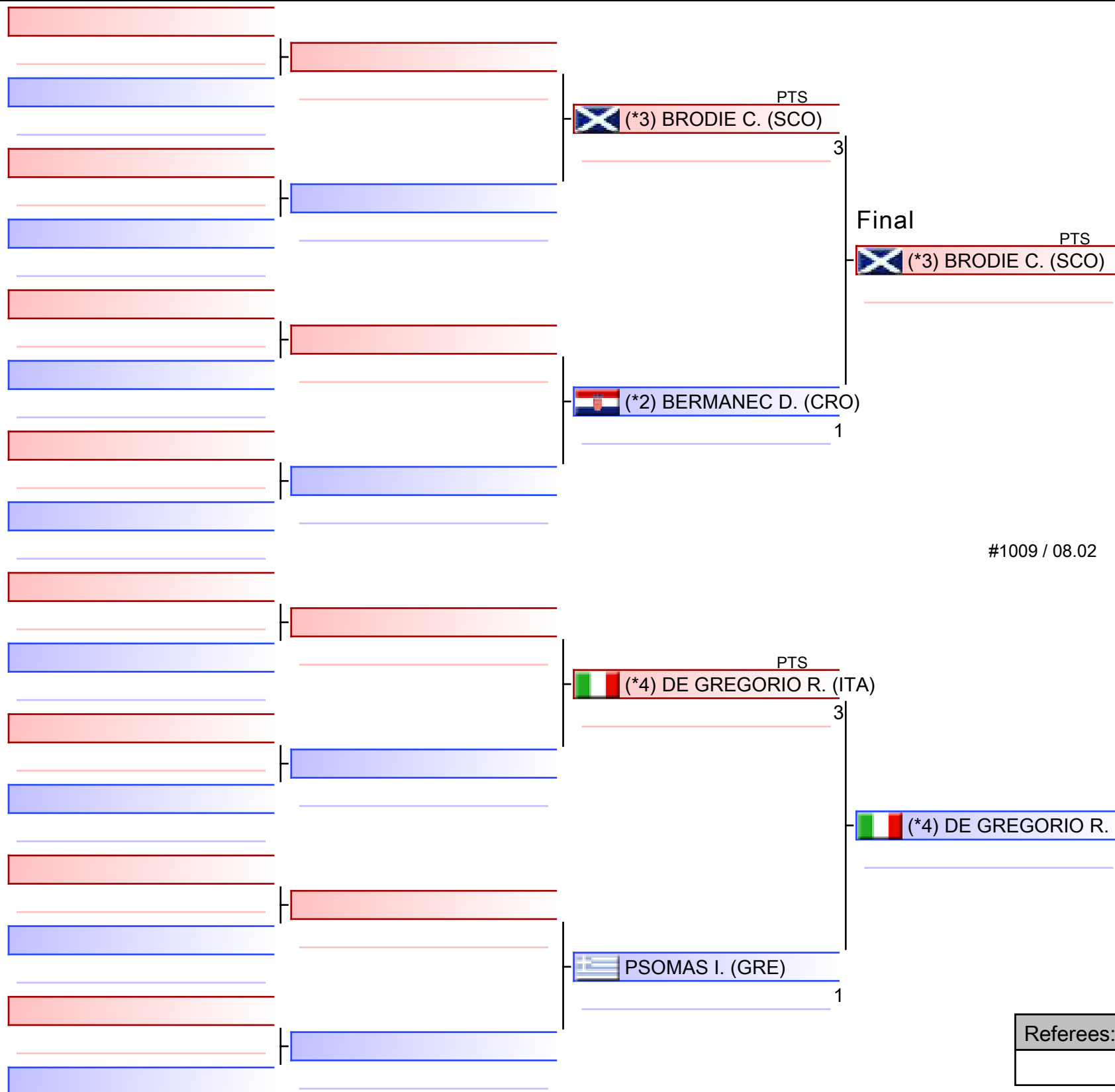

1. BRODIE CULLEN (SCO)
2. DE GREGORIO RICCARDO (ITA)
3. GRISHKIN EGOR (WKF-1)
3. PSOMAS IOANNIS (GRE)
5. BERMANEC DAVID (CRO)
5. BAUMGARTNER CEBRAIL (SUI)
7. RAKOCEVIC LAZAR (MNE)
7. TAKALA ANTON (FIN)

*Seeded

Referees:			

Cadet Kumite Male -70 kg

EKF Junior, Cadet & U21 Championships 2026 - Limassol

2026-02-06

Tatami
2 16:35

Pool
1,2,3,4

(c)sportdata GmbH & Co KG 2000-2026 (2026-02-08 17:46) v 11.0.0 build 2 (2025-01-21 11:49 CET) License: SDIL TWG2025 (expire 2026-09-30)

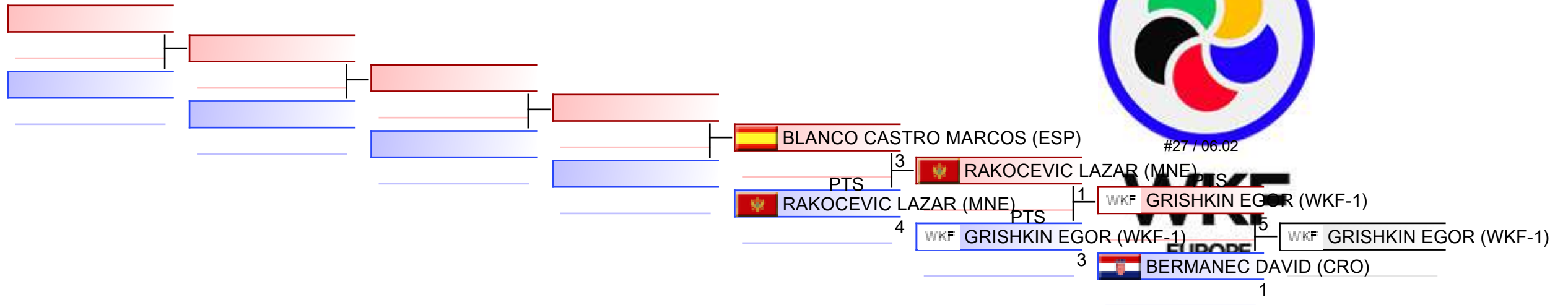

REPECHAGE: (1,2,3,4)

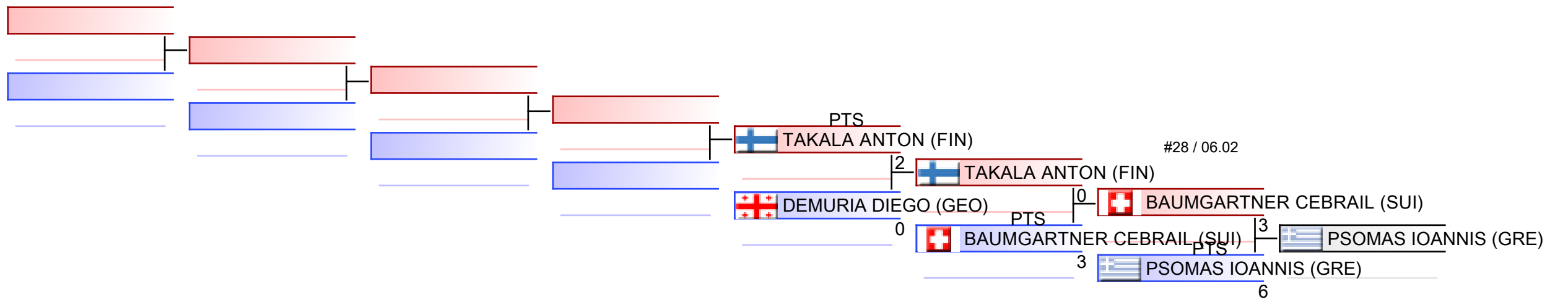

Referees:							
-----------	--	--	--	--	--	--	--



EKF Junior, Cadet & U21 Championships
2026 - Limassol - 2026-02-06



Official Results

Cadet Kumite Male -70 kg			
1	BRODIE CULLEN		SCO - SCOTLAND
2	DE GREGORIO RICCARDO		ITA - ITALY
3	GRISHKIN EGOR		WKF-1 - WKF-1
3	PSOMAS IOANNIS		GRE - GREECE
5	BERMANEC DAVID		CRO - CROATIA
5	BAUMGARTNER CEBRAIL		SUI - SWITZERLAND
7	RAKOCEVIC LAZAR		MNE - MONTENEGRO
7	TAKALA ANTON		FIN - FINLAND
9	BLANCO CASTRO MARCOS		ESP - SPAIN
9	DEMURIA DIEGO		GEO - GEORGIA

CADET KUMITE MALE 70+ KG



EKF Junior, Cadet & U21 Championships 2026 - Lim..

ENTRIES BY WEIGHT CATEGORY



Cadet Kumite Male 70+ kg

As of 8 FEB 2026

Code	ID	Gender	Name	Seeding
ALB	ALB02574	M	BREGU KLESTION	
ARM	ARM003269	M	ABGARYAN AREN	
AZE	AZE03302	M	KAMILOV SHAMO	
BIH	BIH04431	M	ZUNDJA EMIR	
BUL	BUL003181	M	VALKOV NIKOLAY	
CRO	CRO03438	M	FILIPOVIC PETAR	
CYP	CYP003358	M	HADJIHARALAMBOUS CHRISTODOULOS	
CZE	CZE003149	M	VITASEK LUKAS	
ESP	ESP004413	M	JACOBO CASADO FERNANDEZ	
FRA	FRA004196	M	AMMOUR ZIYANE	
GEO	GEO003076	M	GOGRICHIANI OMAR	
GRE	GRE004266	M	LAZARIDIS PANAGIOTIS	
HUN	HUN003513	M	BALI TIBOR	
IRL	IRL003103	M	GORA MARCEL	
ISR	ISR003101	M	VOLFSON TAL	4
ITA	ITA005914	M	DEL SEPPIA GIACOMO	2
LTU	LTU002738	M	LOGVINENKO KIRIL	
MKD	MKD03028	M	MLADENOVIC NEMANJA	
MNE	MNE03073	M	KOSOVIC ANDRIJA	
NED	NED003576	M	ZARCHID MONCEF	
POR	POR003479	M	CIUNTU DANIEL	
ROU	ROU03242	M	IGARELU VICTOR	3
SRB	SRB03032	M	JOKIC STRAHINJA	
SVK	SVK003254	M	MITRIK RICHARD	1
SWE	SWE003400	M	ALFREDSSON JOEL	
UKR	UKR003916	M	BAIOL MYKOLA	
WKF-1	WKF105719	M	MAKSIMOV ALEXANDR	

Cadet Kumite Male 70+ kg

EKF Junior, Cadet & U21 Championships 2026 - Limassol, Spyros Kyprianou Athletic Center, Limassol, CYP

2026-02-06

Tatami
5 15:55

Pool
1/4

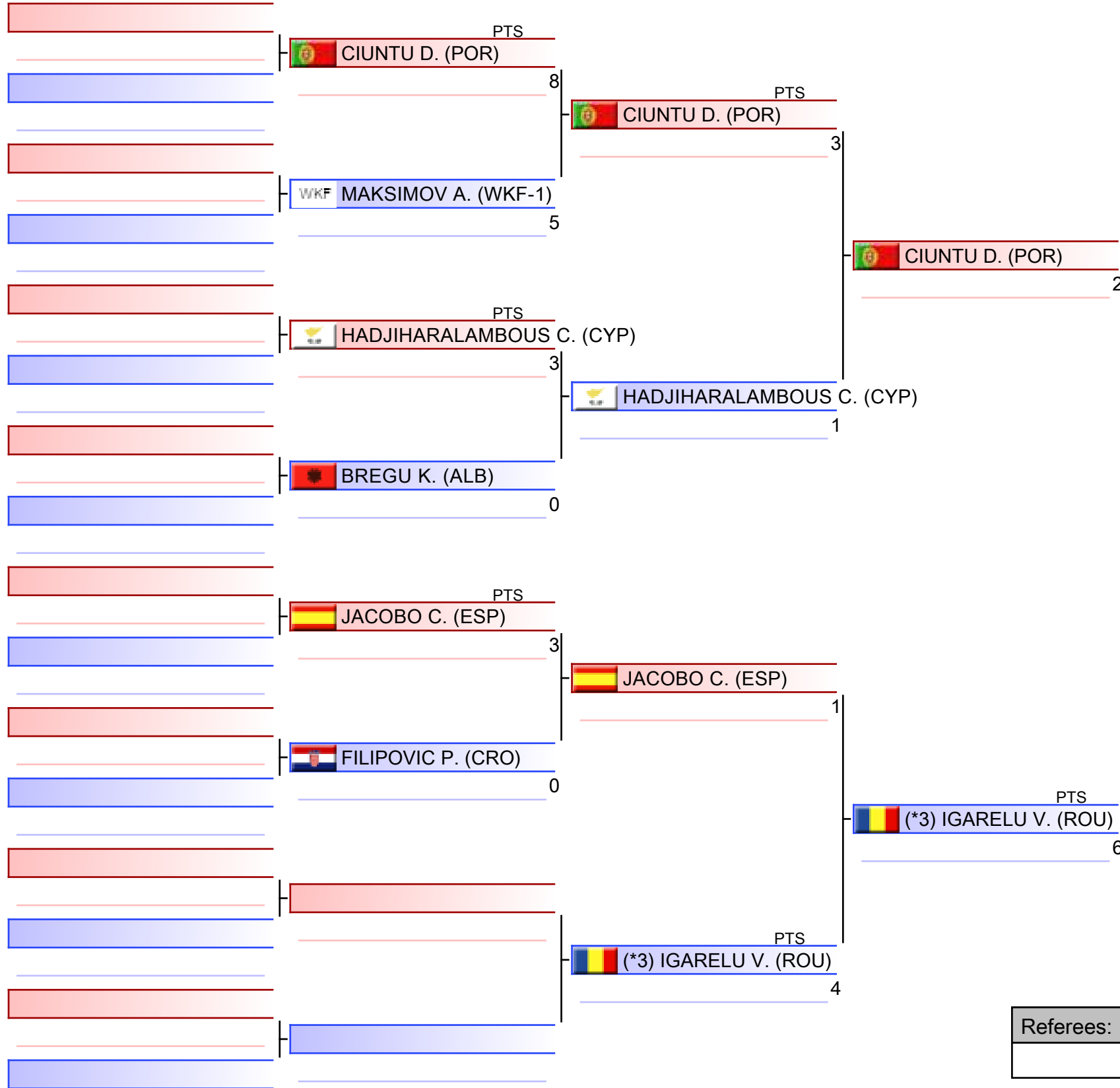

WKF
EUROPE

(*3) IGARELU V. (ROU)

1. GOGRIKHIANI OMAR (GEO)
2. MLADENOVIC NEMANJA (MKD)
3. MITRIK RICHARD (SVK)
3. IGARELU VICTOR (ROU)
5. LAZARIDIS PANAGIOTIS (GRE)
5. ZUNDJA EMIR (BIH)
7. VITASEK LUKAS (CZE)
7. KAMILOV SHAMO (AZE)

*Seeded

Referees:			

Cadet Kumite Male 70+ kg

EKF Junior, Cadet & U21 Championships 2026 - Limassol, Spyros Kyprianou Athletic Center, Limassol, CYP

2026-02-06

Tatami
6 15:55

Pool
2/4



WKF
EUROPE

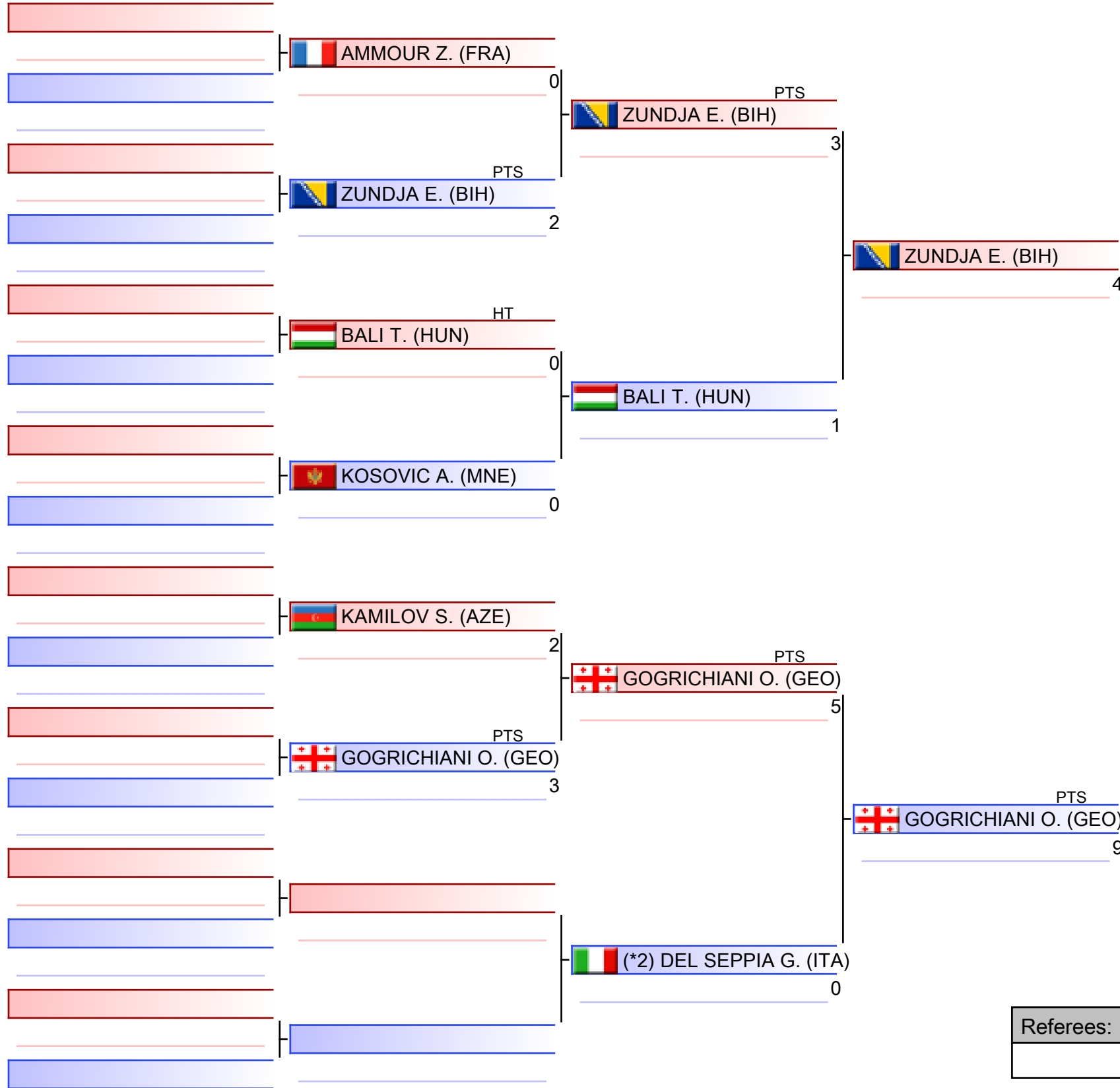

GOGRICHIANI O. (GEO)

1. GOGRICHIANI OMAR (GEO)
2. MLADENOVIC NEMANJA (MKD)
3. MITRIK RICHARD (SVK)
3. IGARELU VICTOR (ROU)
5. LAZARIDIS PANAGIOTIS (GRE)
5. ZUNDJA EMIR (BIH)
7. VITASEK LUKAS (CZE)
7. KAMILOV SHAMO (AZE)

*Seeded

Referees:			

Cadet Kumite Male 70+ kg

EKF Junior, Cadet & U21 Championships 2026 - Limassol, Spyros Kyprianou Athletic Center, Limassol, CYP

2026-02-06

Tatami
7 15:45

Pool
3/4



WKF
EUROPE

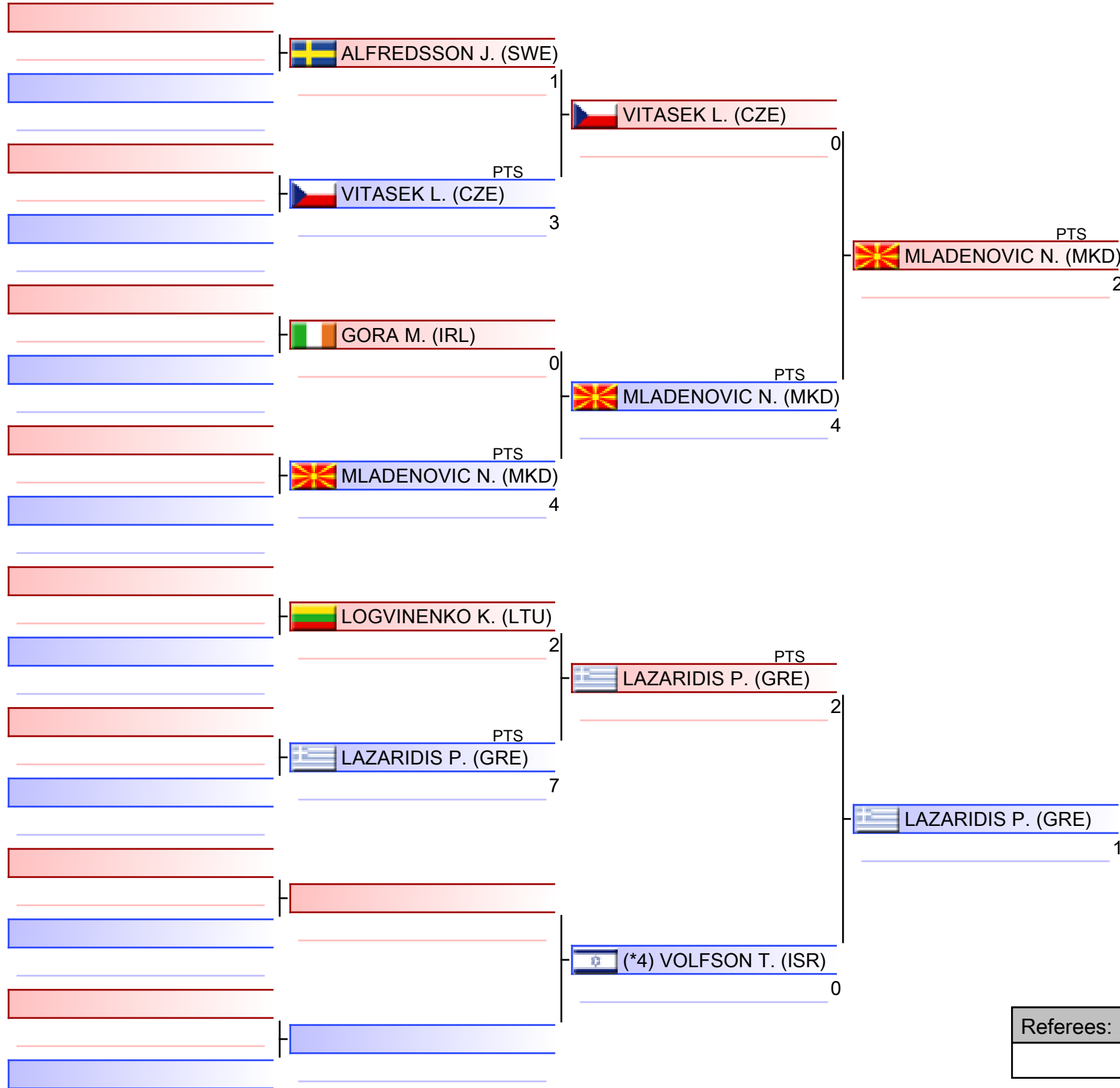

MLADENOVIC N. (MKD)

1. GOGRIKIANI OMAR (GEO)
2. MLADENOVIC NEMANJA (MKD)
3. MITRIK RICHARD (SVK)
3. IGARELU VICTOR (ROU)
5. LAZARIDIS PANAGIOTIS (GRE)
5. ZUNDJA EMIR (BIH)
7. VITASEK LUKAS (CZE)
7. KAMILOV SHAMO (AZE)

*Seeded

Referees:			

Cadet Kumite Male 70+ kg

EKF Junior, Cadet & U21 Championships 2026 - Limassol, Spyros Kyprianou Athletic Center, Limassol, CYP

2026-02-06

Tatami
8 15:45

Pool
4/4



WKF
EUROPE

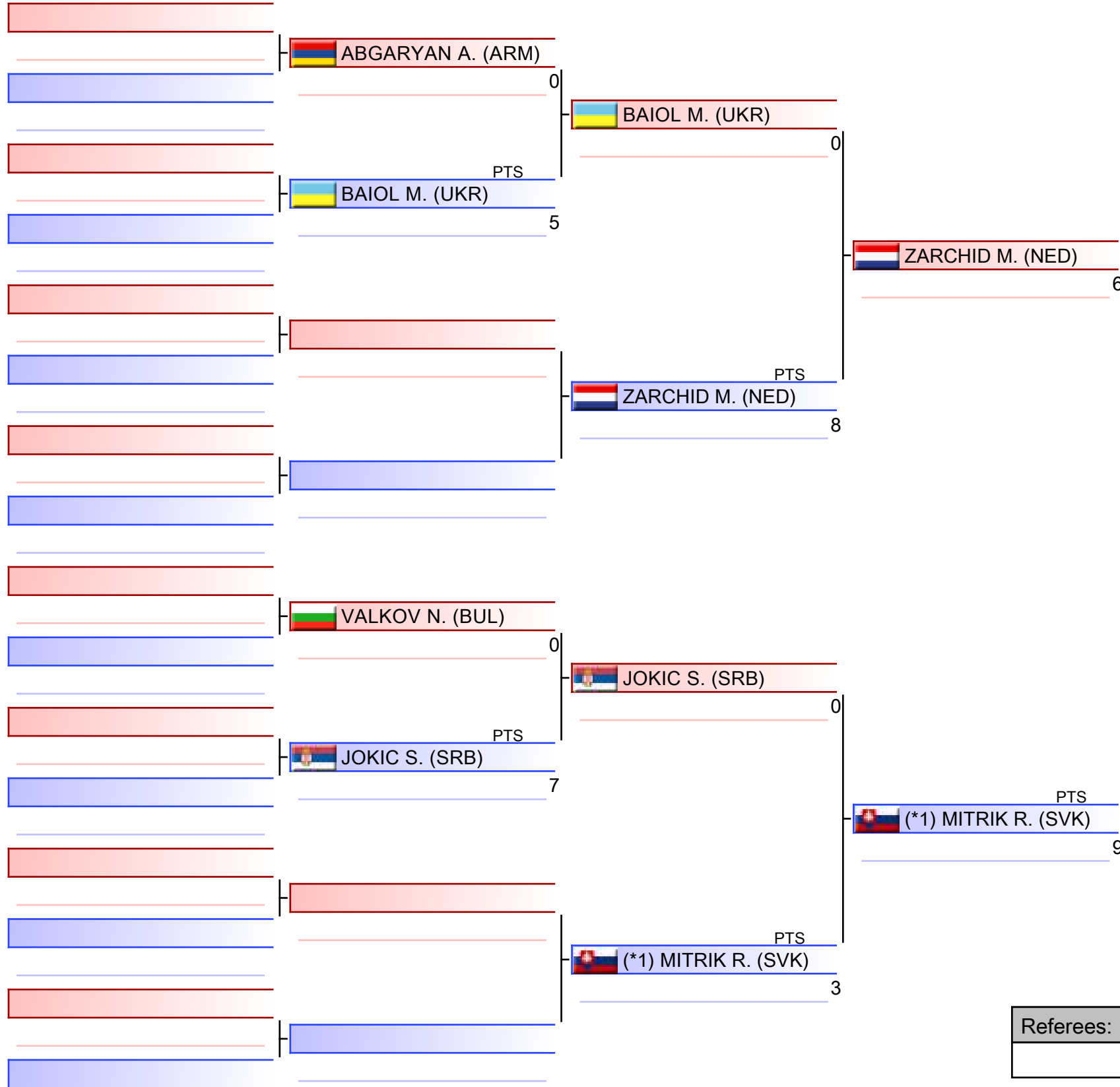

(*1) MITRIK R. (SVK)

1. GOGRIKHIANI OMAR (GEO)
2. MLADENOVIC NEMANJA (MKD)
3. MITRIK RICHARD (SVK)
3. IGARELU VICTOR (ROU)
5. LAZARIDIS PANAGIOTIS (GRE)
5. ZUNDJA EMIR (BIH)
7. VITASEK LUKAS (CZE)
7. KAMILOV SHAMO (AZE)

*Seeded

Referees:			

Pool winner-Cadet Kumite Male 70+ kg

EKF Junior, Cadet & U21 Championships 2026 - Limassol, Spyros Kyprianou Athletic Center, Limsassol, CYP

2026-02-06

Tatami
5 16:30

Pool
1/1



WKF
EUROPE

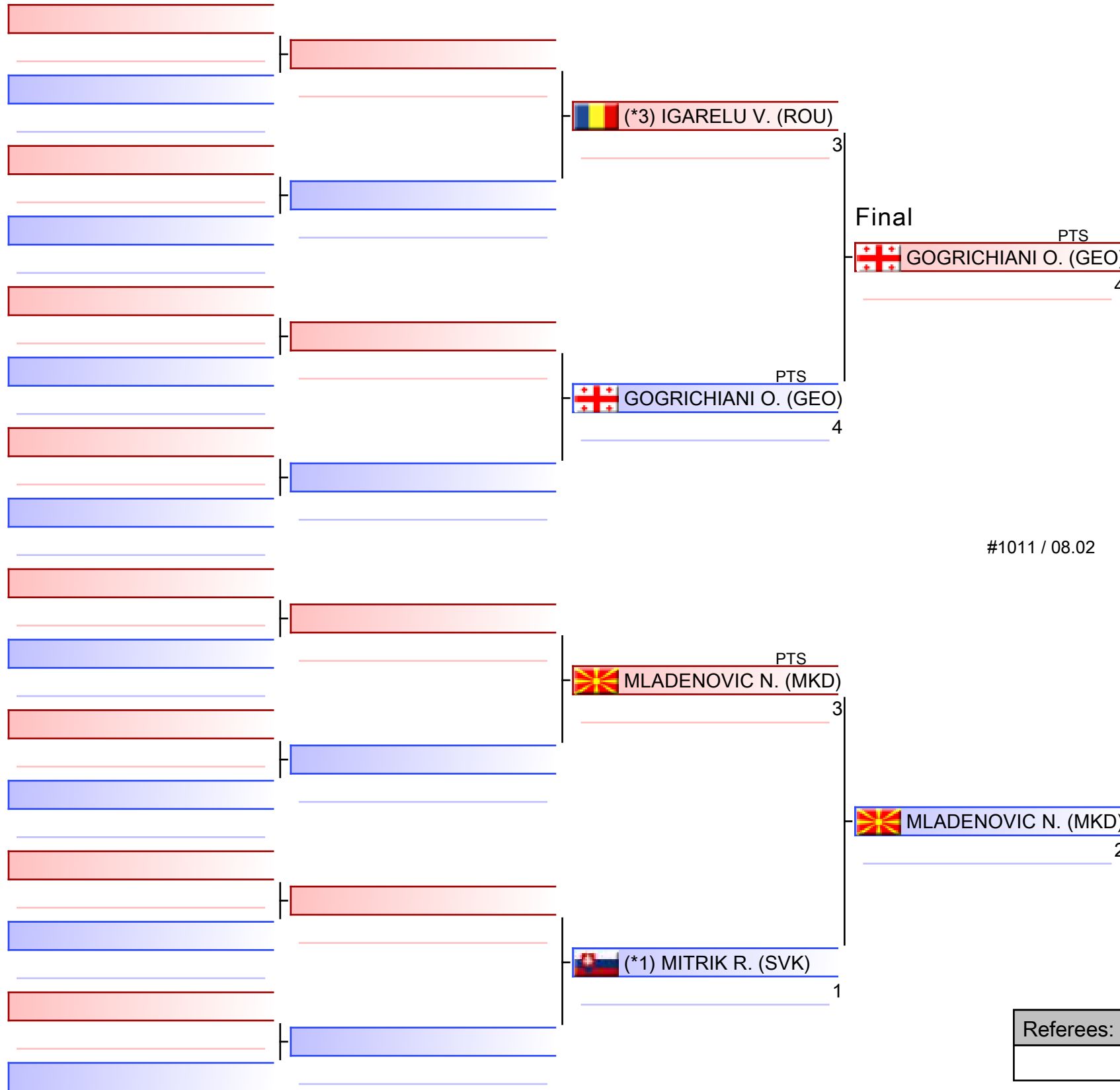

1. GOGRICHIANI OMAR (GEO)
2. MLADENOVIC NEMANJA (MKD)
3. MITRIK RICHARD (SVK)
3. IGARELU VICTOR (ROU)
5. LAZARIDIS PANAGIOTIS (GRE)
5. ZUNDJA EMIR (BIH)
7. VITASEK LUKAS (CZE)
7. KAMILOV SHAMO (AZE)

*Seeded

Referees:			

Cadet Kumite Male 70+ kg

EKF Junior, Cadet & U21 Championships 2026 - Limassol

2026-02-06

Tatami
5 16:35

Pool
1,2

(c)sportdata GmbH & Co KG 2000-2026 (2026-02-08 17:46) v 11.0.0 build 2 (2025-01-21 11:49 CET) License: SDIL TWG2025 (expire 2026-09-30)

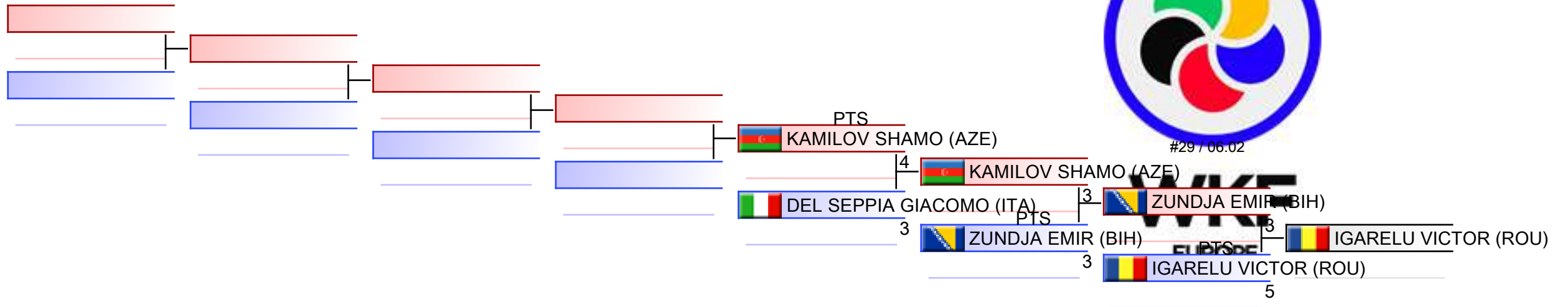

REPECHAGE: (1,2)

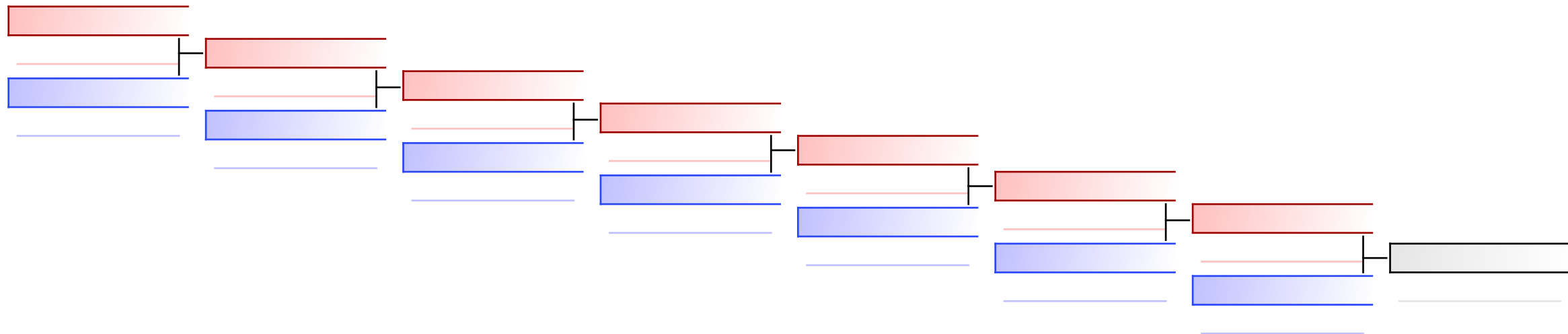

Referees:							
-----------	--	--	--	--	--	--	--

Cadet Kumite Male 70+ kg

EKF Junior, Cadet & U21 Championships 2026 - Limassol

2026-02-06

Tatami
7 16:25

Pool
3,4

(c)sportdata GmbH & Co KG 2000-2026 (2026-02-08 17:46) v 11.0.0 build 2 (2025-01-21 11:49 CET) License: SDIL TWG2025 (expire 2026-09-30)

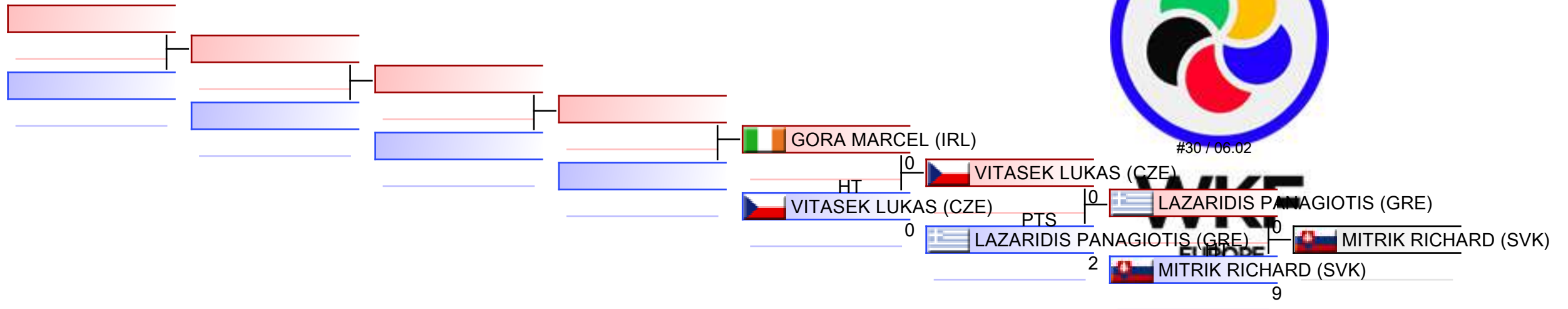

REPECHAGE: (3,4)

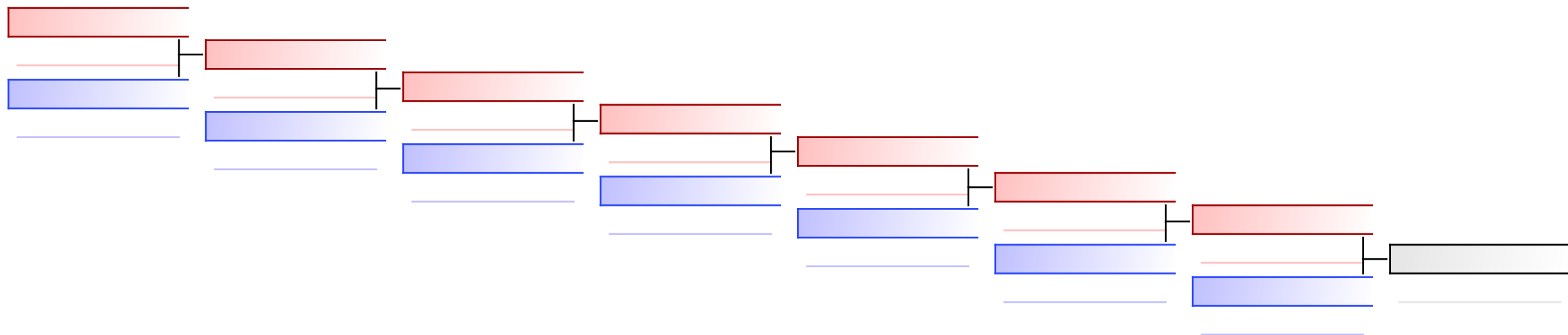

Referees:							
-----------	--	--	--	--	--	--	--



EKF Junior, Cadet & U21 Championships
2026 - Limassol - 2026-02-06



Official Results

Cadet Kumite Male 70+ kg			
1	GOGRICHIANI OMAR		GEO - GEORGIA
2	MLADENOVIC NEMANJA		MKD - NORTH MACEDONIA
3	MITRIK RICHARD		SVK - SLOVAKIA
3	IGARELU VICTOR		ROU - ROMANIA
5	LAZARIDIS PANAGIOTIS		GRE - GREECE
5	ZUNDJA EMIR		BIH - BOSNIA AND HERZEGOVINA
7	VITASEK LUKAS		CZE - CZECH REPUBLIC
7	KAMILOV SHAMO		AZE - AZERBAIJAN
9	GORA MARCEL		IRL - IRELAND
9	DEL SEPIA GIACOMO		ITA - ITALY

JUNIOR KATA FEMALE



EKF Junior, Cadet & U21 Championships 2026 - Lim..



ENTRIES BY WEIGHT CATEGORY

Junior Kata Female

As of 8 FEB 2026

Code	ID	Gender	Name	Seeding
AUT	AUT02674	F	LEHNER TAMARA	3
BEL	BEL03143	F	MANCA GIULIA	2
BIH	BIH2805	F	BAHIC ALDINA	
CRO	CRO03813	F	JURCEVIC LARA	
CYP	CYP03110	F	KARAYIANNIDOU ATHINA IOANNA	
CZE	CZE02535	F	KUBINOVA ANNA	
DEN	DEN003003	F	EMDE SARA	
ENG	ENG03253	F	WEGRZYN NADA	
ESP	ESP004279	F	CASTRO LOPEZ ROCIO	
EST	EST002738	F	ANTONOVA ANNIKA	
FRA	FRA03840	F	VAUCELLE-SPELLE NINON	
GER	GER004072	F	LIBIK TAMARA	
GRE	GRE03095	F	ZERVOU ELENI	
ITA	ITA005582	F	CRUCITTI SOFIA	
LUX	LUX02321	F	BREISCH ANNA	
MDA	MDA02413	F	SERBUL ALEXANDRINA	
MKD	MKD03003	F	ZENDELI BLERINA	
MLT	MLT02201	F	SALIBA FRANCESCA	
MNE	MNE2426	F	VLAHOVIC KATARINA	
POL	POL2858	F	ZUREK MILENA	
POR	POR02873	F	MARQUES RITA	1
ROU	ROU03577	F	ASABI TIMEEA GAGEA	
SLO	SLO02926	F	KREGAR GABRIELA	
SUI	SUI02740	F	RITZ LILA	
SVK	SVK03126	F	FIALKOVA SOFIA	4
SWE	SWE003352	F	VAPPER MINOU	
UKR	UKR03150	F	BARANOVA ULIANA	
WKF-1	WKF-1006798	F	NIKOLAEVA NATALIA	
WKF-2	AIN-2002776	F	RUDZENCHANKA VIKTORYIA	

Junior Kata Female

EKF Junior, Cadet & U21 Championships 2026 - Limassol, Spyros Kyprianou Athletic Center, Limassol, CYP

2026-02-06

Tatami
5 10:05

Pool
1/4



WKF
EUROPE

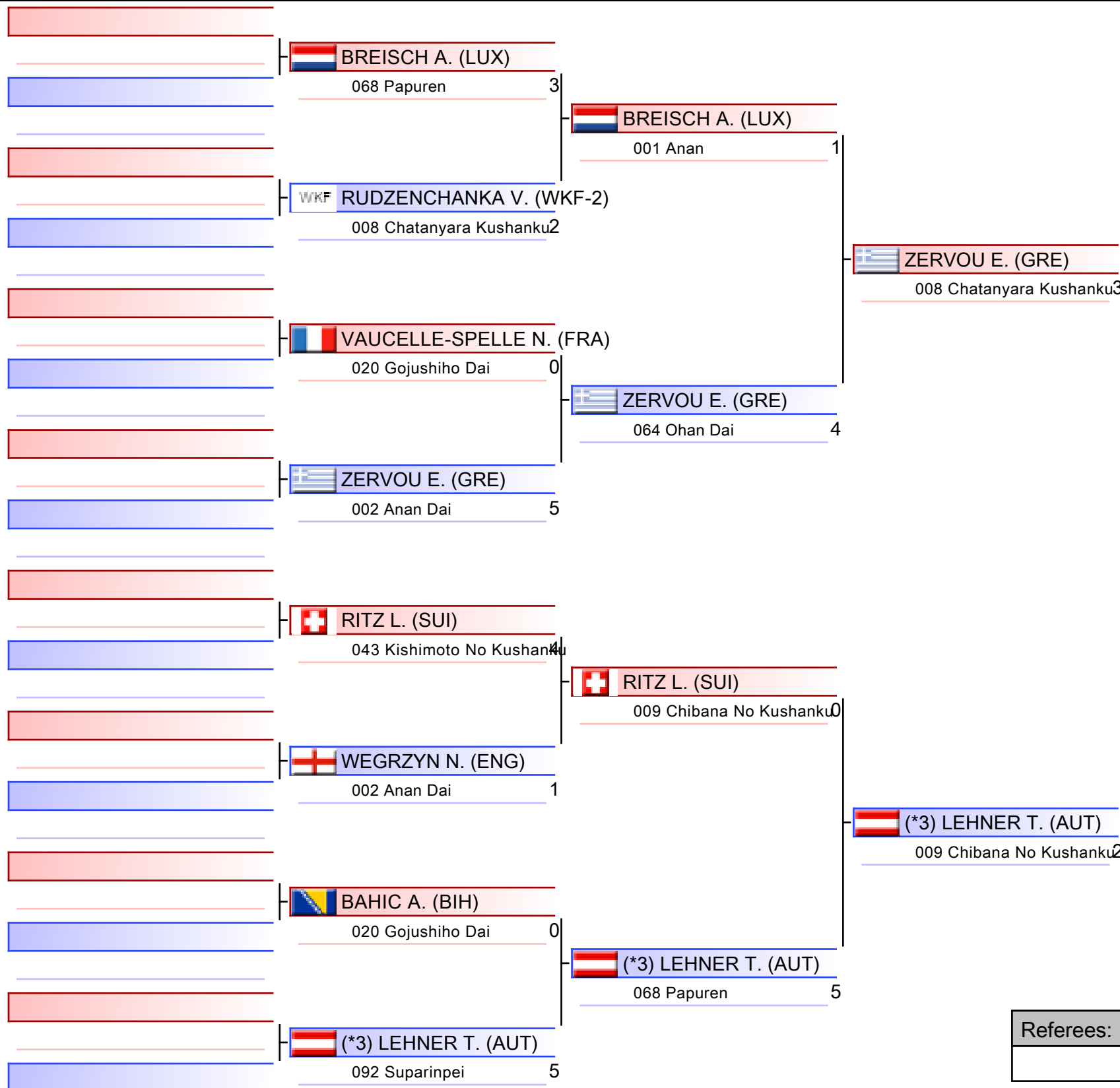

ZERVOU E. (GRE)

1. MARQUES RITA (POR)
2. MANCA GIULIA (BEL)
3. CASTRO LOPEZ ROCIO (ESP)
3. JURCEVIC LARA (CRO)
5. LIBIK TAMARA (GER)
5. ZERVOU ELENI (GRE)
7. VAPPER MINOU (SWE)
7. SALIBA FRANCESCA (MLT)

*Seeded

Referees:			

Junior Kata Female

EKF Junior, Cadet & U21 Championships 2026 - Limassol, Spyros Kyprianou Athletic Center, Limassol, CYP

2026-02-06

Tatami
6 10:05

Pool
2/4



WKF
EUROPE

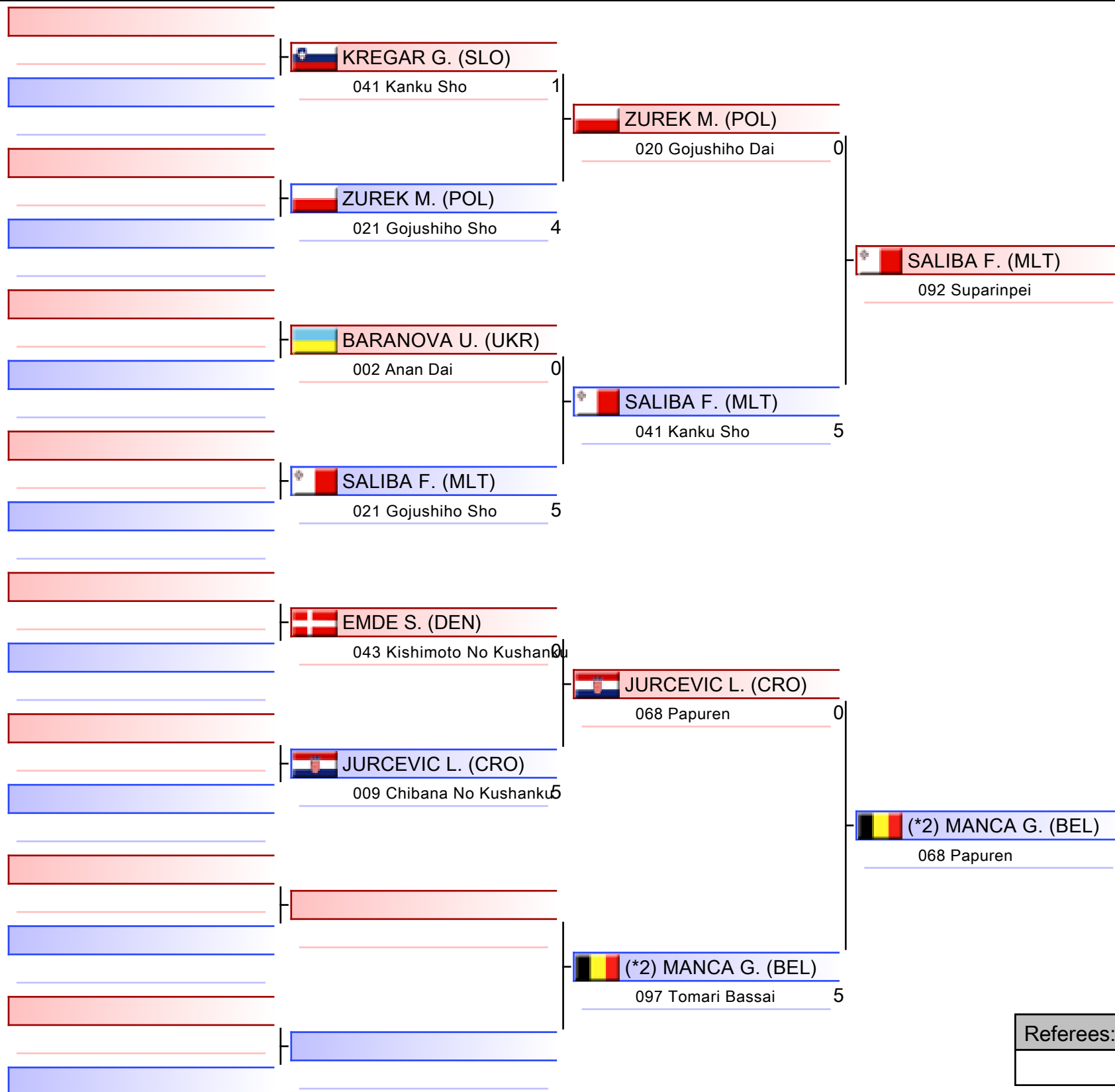

(*2) MANCA G. (BEL)

1. MARQUES RITA (POR)
2. MANCA GIULIA (BEL)
3. CASTRO LOPEZ ROCIO (ESP)
3. JURCEVIC LARA (CRO)
5. LIBIK TAMARA (GER)
5. ZERVOU ELENI (GRE)
7. VAPPER MINOU (SWE)
7. SALIBA FRANCESCA (MLT)

*Seeded

Referees:			

Junior Kata Female

EKF Junior, Cadet & U21 Championships 2026 - Limassol, Spyros Kyprianou Athletic Center, Limassol, CYP

2026-02-06

Tatami
7 10:05

Pool
3/4



WKF
EUROPE

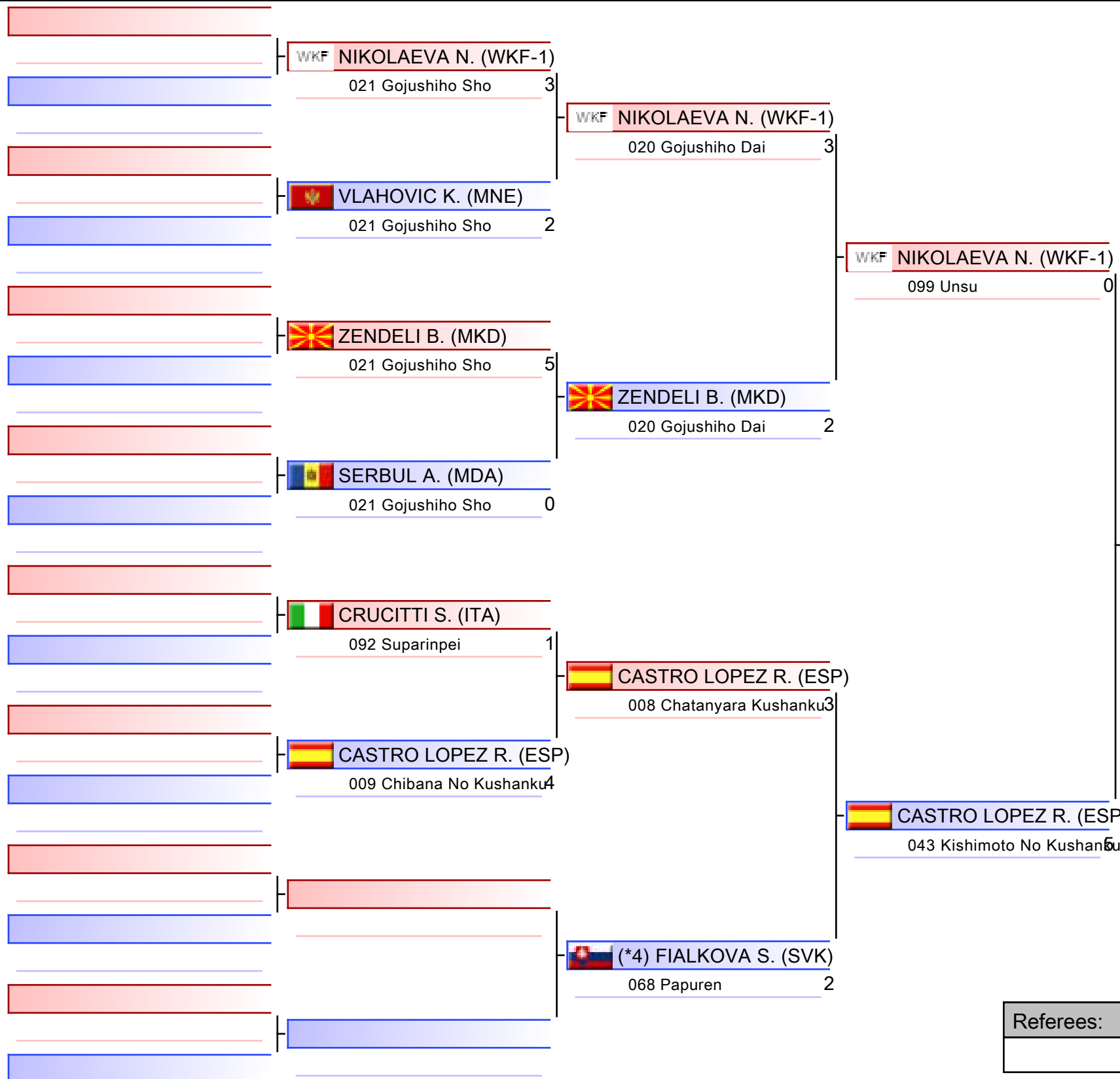

CASTRO LOPEZ R. (ESP)

1. MARQUES RITA (POR)
2. MANCA GIULIA (BEL)
3. CASTRO LOPEZ ROCIO (ESP)
3. JURCEVIC LARA (CRO)
5. LIBIK TAMARA (GER)
5. ZERVOU ELENI (GRE)
7. VAPPER MINOU (SWE)
7. SALIBA FRANCESCA (MLT)

*Seeded

Referees:			

Junior Kata Female

EKF Junior, Cadet & U21 Championships 2026 - Limassol, Spyros Kyprianou Athletic Center, Limassol, CYP

2026-02-06

Tatami
8 10:05

Pool
4/4



WKF
EUROPE

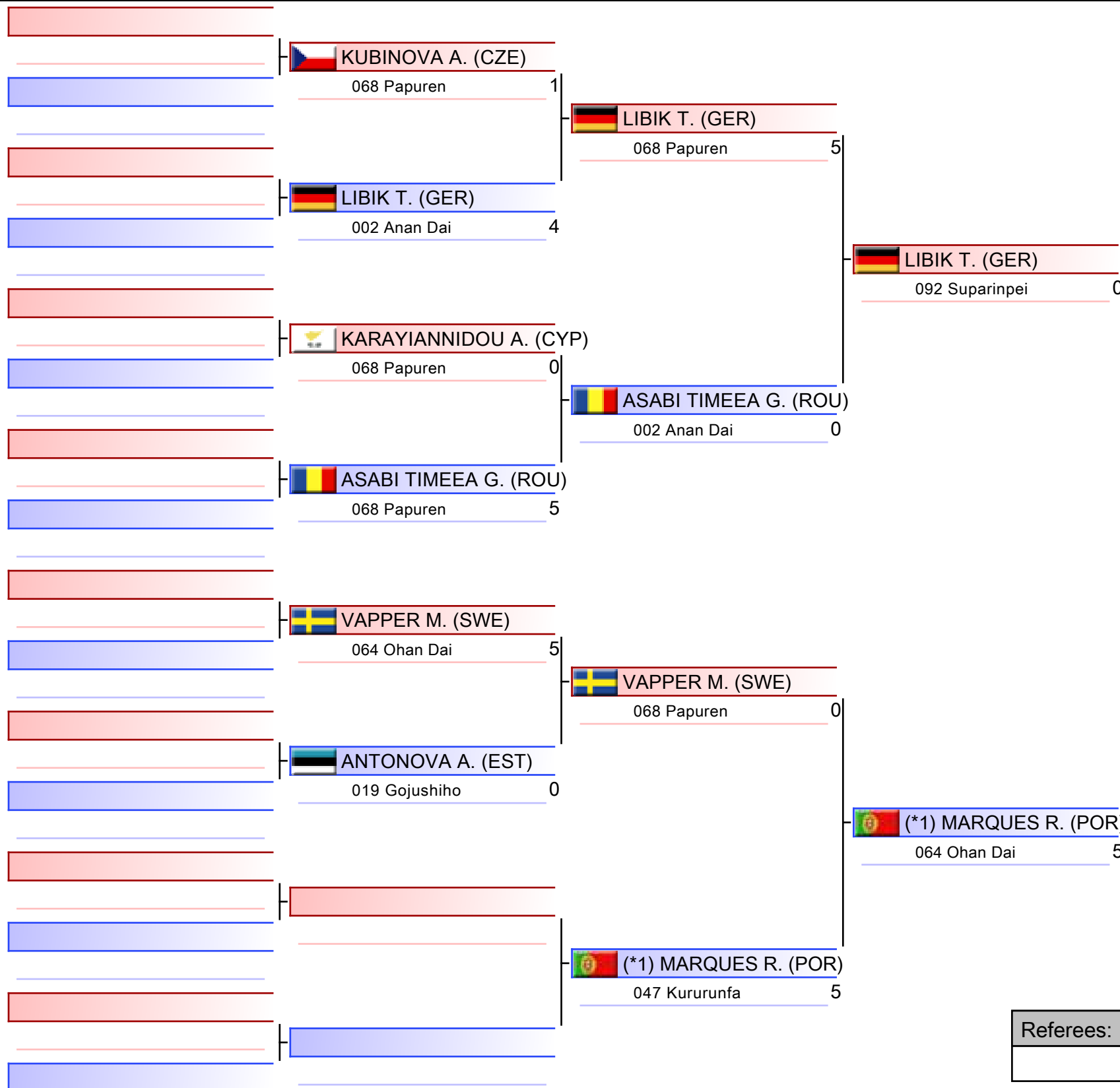

(*1) MARQUES R. (POR)

1. MARQUES RITA (POR)
2. MANCA GIULIA (BEL)
3. CASTRO LOPEZ ROCIO (ESP)
3. JURCEVIC LARA (CRO)
5. LIBIK TAMARA (GER)
5. ZERVOU ELENI (GRE)
7. VAPPER MINOU (SWE)
7. SALIBA FRANCESCA (MLT)

*Seeded

Referees:			

Pool winner-Junior Kata Female

EKF Junior, Cadet & U21 Championships 2026 - Limassol, Spyros Kyprianou Athletic Center, Limsassol, CYP

2026-02-06

Tatami
6 11:00

Pool
1/1



WKF
EUROPE

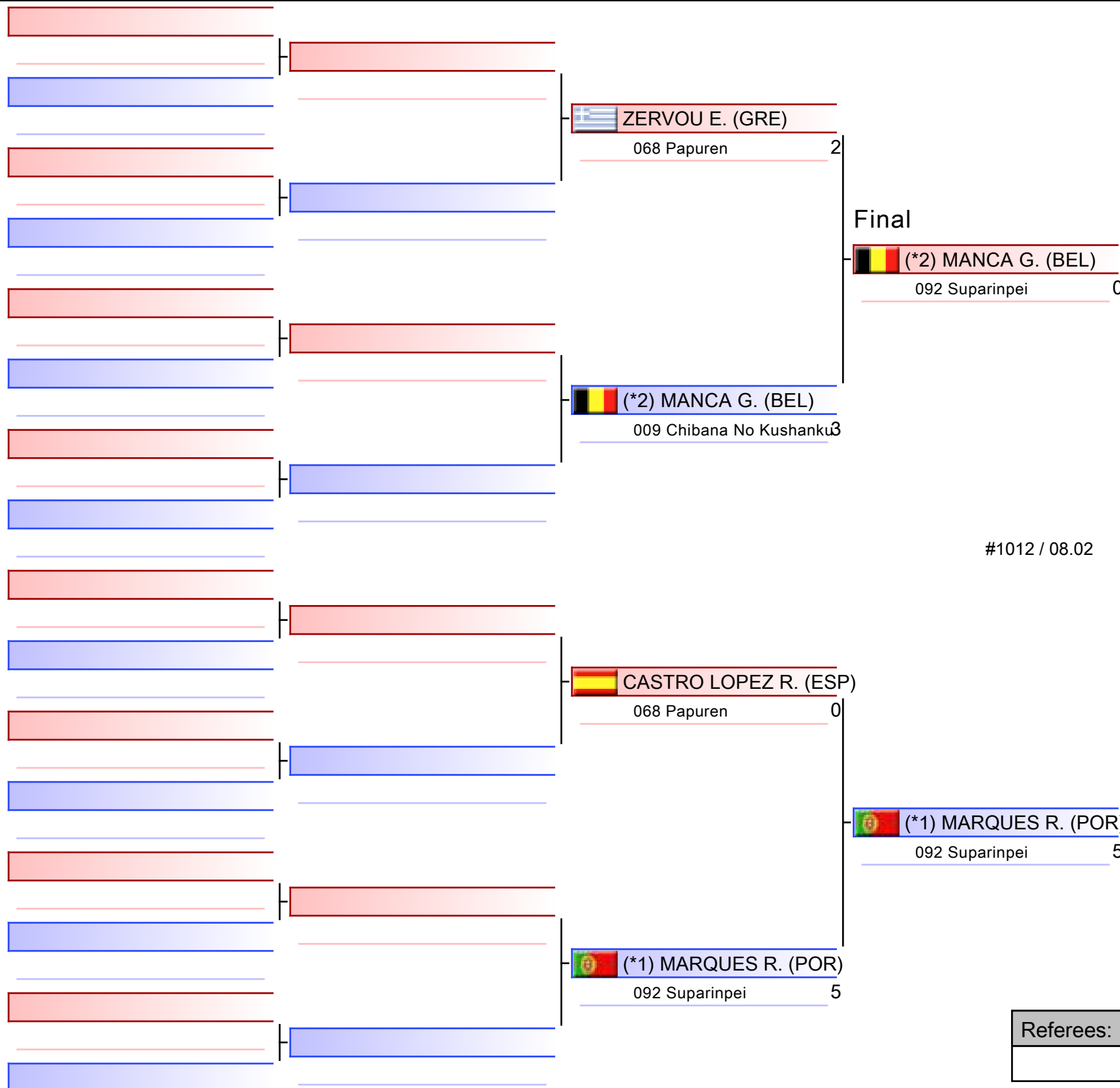

1. MARQUES RITA (POR)
2. MANCA GIULIA (BEL)
3. CASTRO LOPEZ ROCIO (ESP)
3. JURCEVIC LARA (CRO)
5. LIBIK TAMARA (GER)
5. ZERVOU ELENI (GRE)
7. VAPPER MINOU (SWE)
7. SALIBA FRANCESCA (MLT)

*Seeded

Referees:			

Junior Kata Female

EKF Junior, Cadet & U21 Championships 2026 - Limassol

2026-02-06

Tatami

3 12:15

Pool

1,2,3,4

(c)sportdata GmbH & Co KG 2000-2026 (2026-02-08 17:46) v 11.0.0 build 2 (2025-01-21 11:49 CET) License: SDIL TWG2025 (expire 2026-09-30)



#5 / 06.02

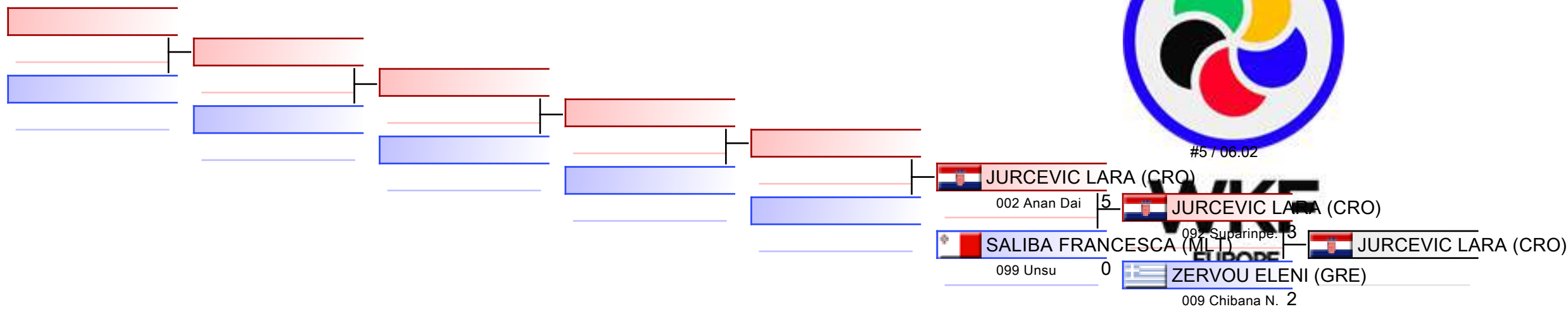

REPECHAGE: (1,2,3,4)

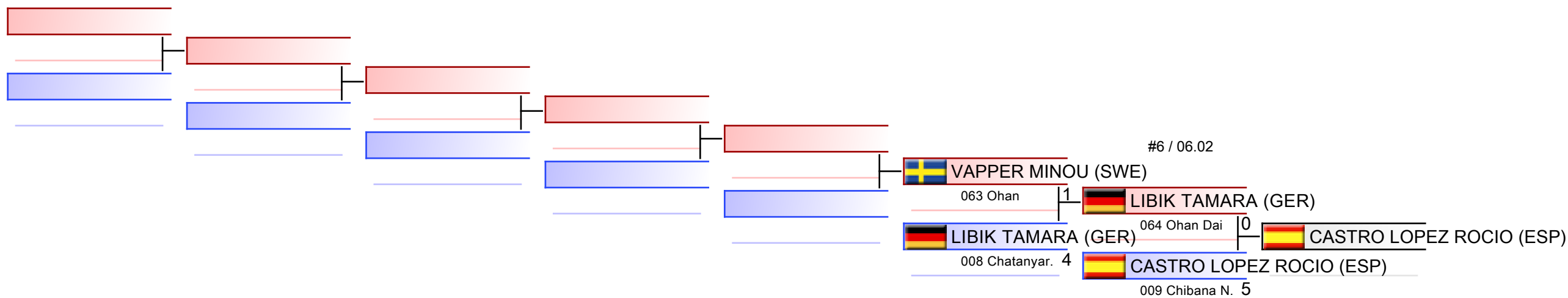

Referees:							
-----------	--	--	--	--	--	--	--



EKF Junior, Cadet & U21 Championships
2026 - Limassol - 2026-02-06



Official Results

Junior Kata Female			
1	MARQUES RITA		POR - PORTUGAL
2	MANCA GIULIA		BEL - BELGIUM
3	CASTRO LOPEZ ROCIO		ESP - SPAIN
3	JURCEVIC LARA		CRO - CROATIA
5	LIBIK TAMARA		GER - GERMANY
5	ZERVOU ELENI		GRE - GREECE
7	VAPPER MINOU		SWE - SWEDEN
7	SALIBA FRANCESCA		MLT - MALTA

JUNIOR KATA MALE



EKF Junior, Cadet & U21 Championships 2026 - Lim..



ENTRIES BY WEIGHT CATEGORY

Junior Kata Male

As of 8 FEB 2026

Code	ID	Gender	Name	Seeding
AUT	AUT03000	M	LIST FABIO	
AZE	AZE02551	M	SALMANOV SALMAN	
BIH	BIH03764	M	MUSIC ADIN	
BUL	BUL02461	M	APRILOV DENIS	
CRO	CRO03422	M	GRGIC OZREN	
CYP	CYP02822	M	EFTHYMIOU CHRISTOS	
CZE	CZE003005	M	BRZOBOHATY MICHAL	
DEN	DEN02842	M	PETERSEN LUKAS MURAKAMI	
ENG	ENG03247	M	LANGHORN THEO	4
ESP	ESP004094	M	LEON DE LA PENA JOSE ANGEL	3
FRA	FRA04085	M	KLEMZ THOMAS	2
GER	GER004275	M	JORDE-NAKAMATSU LIO	
GRE	GRE03703	M	PAPPAS CHARILAOS	
IRL	IRL02945	M	WONG-LYE CHRISTOPHER CHUNG YIN	
ISL	ISL002492	M	BUENVIAJE CAAMIC PRINCE JAMES	
ITA	ITA005923	M	MARCHESE LUCIO	
LAT	LAT003118	M	DRILLIS EMILS	
LTU	LTU002629	M	GASICKAS ROKAS	
LUX	LUX02425	M	ARCQ ALEXANDER	
MKD	MKD2476	M	DERVISHI NUREDIN	
MNE	MNE03125	M	ALJOSEVIC BENJAMIN	
NED	NED003578	M	NOERKHAN RAYAN	
NOR	NOR003015	M	MELTZER ISAAC AUGUST	
POL	POL12789	M	SNIEGOCKI SZYMON	
POR	SD59627	M	MATEUS VASCO	1
ROU	ROU03762	M	HABEANU RARES CRISTIAN	
SLO	SLO02796	M	CICVARIC LUKA	
SRB	SRB2468	M	PAUNOVIC DJORDJE	
SUI	SUI02743	M	SCHEDEL NOLAN	
SVK	SVK02796	M	GENDES DAVID	
SWE	SWE003124	M	JONASSON JAKOB	
UKR	UKR003915	M	NEVOZHAI MAKSYM	
WAL	WAL002520	M	MAJOR EMMANUEL	
WKF-1	AIN-1006355	M	BAKIROV ELSHAN	

Junior Kata Male

EKF Junior, Cadet & U21 Championships 2026 - Limassol, Spyros Kyprianou Athletic Center, Limassol, CYP

2026-02-06

Tatami
1 10:00

Pool
1/4

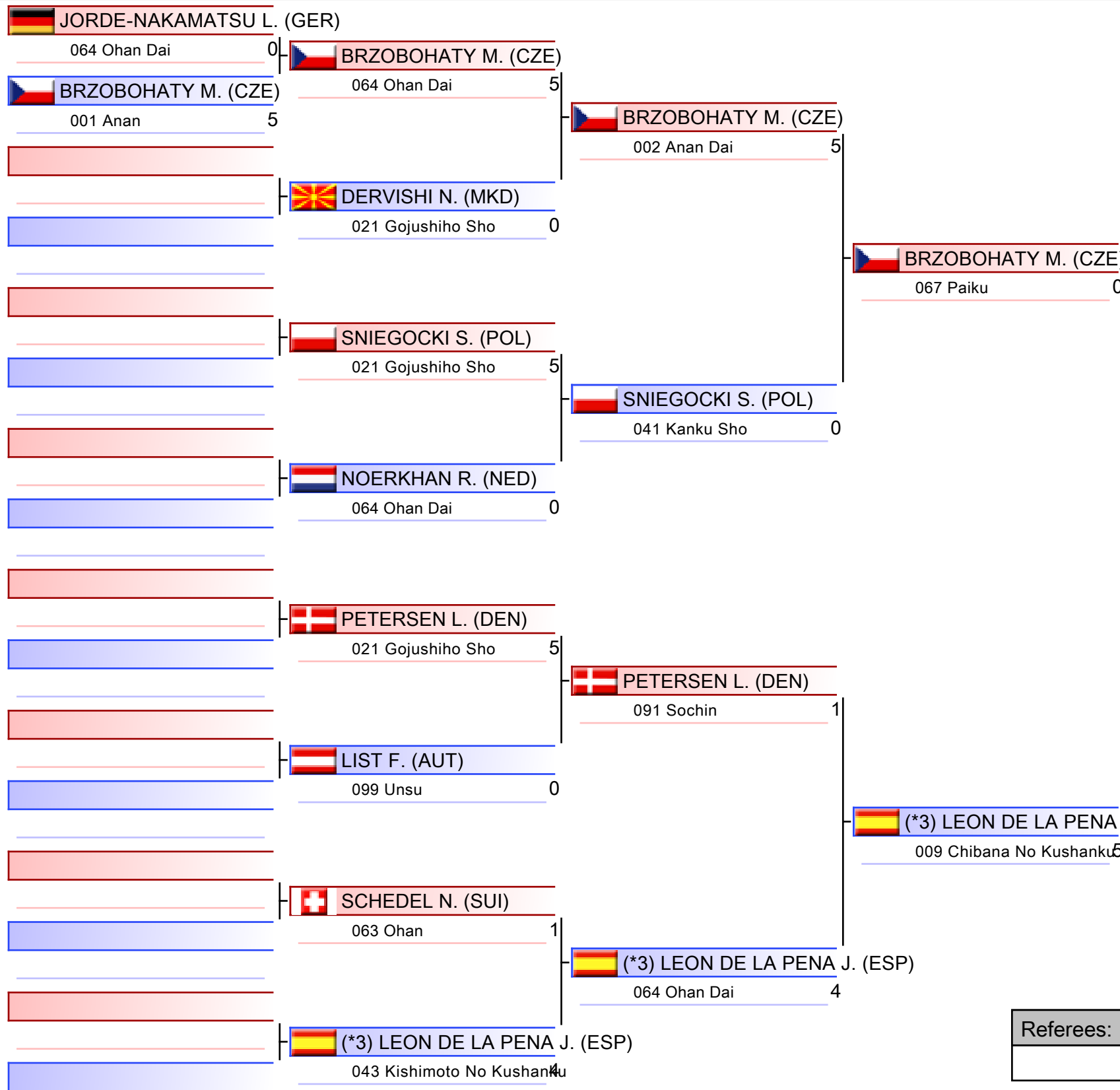

(*3) LEON DE LA PENNA J. (ESP)

1. MATEUS VASCO (POR)
2. LEON DE LA PENNA JOSE ANGEL (ESP)
3. KLEMM THOMAS (FRA)
3. SALMANOV SALMAN (AZE)
5. BRZOBOHATY MICHAL (CZE)
5. MARCHESE LUCIO (ITA)
7. PETERSEN LUKAS MURAKAMI (DEN)
7. MAJOR EMMANUEL (WAL)

*Seeded

Referees:			

Junior Kata Male

EKF Junior, Cadet & U21 Championships 2026 - Limassol, Spyros Kyprianou Athletic Center, Limassol, CYP

2026-02-06

Tatami
2 10:00

Pool
2/4



WKF
EUROPE

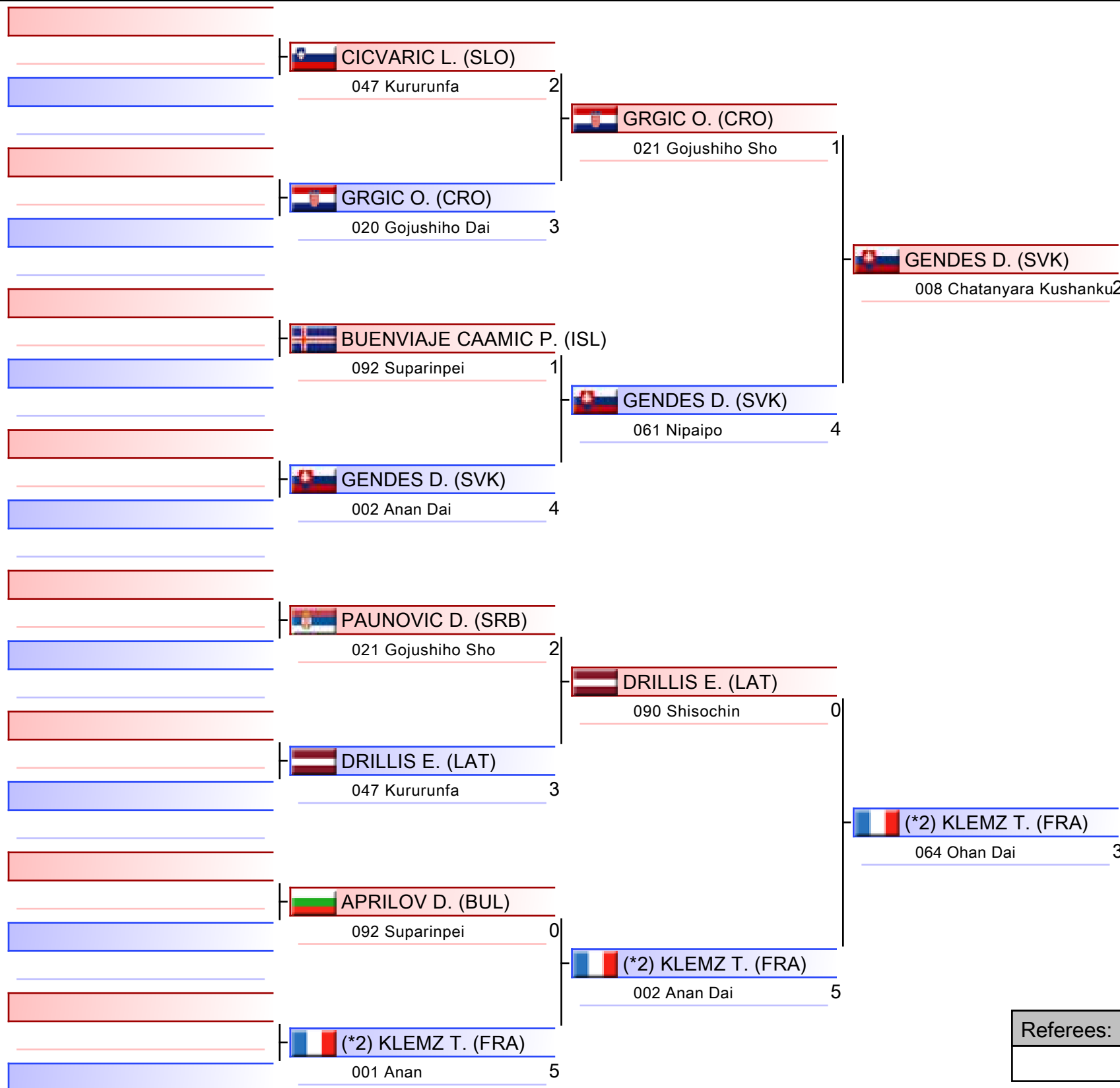

(*2) KLEMZ T. (FRA)

1. MATEUS VASCO (POR)
2. LEON DE LA PENA JOSE ANGEL (ESP)
3. KLEMZ THOMAS (FRA)
3. SALMANOV SALMAN (AZE)
5. BRZOBHATY MICHAL (CZE)
5. MARCHESE LUCIO (ITA)
7. PETERSEN LUKAS MURAKAMI (DEN)
7. MAJOR EMMANUEL (WAL)

*Seeded

Referees:			

Junior Kata Male

EKF Junior, Cadet & U21 Championships 2026 - Limassol, Spyros Kyprianou Athletic Center, Limassol, CYP

2026-02-06

Tatami
3 10:00

Pool
3/4

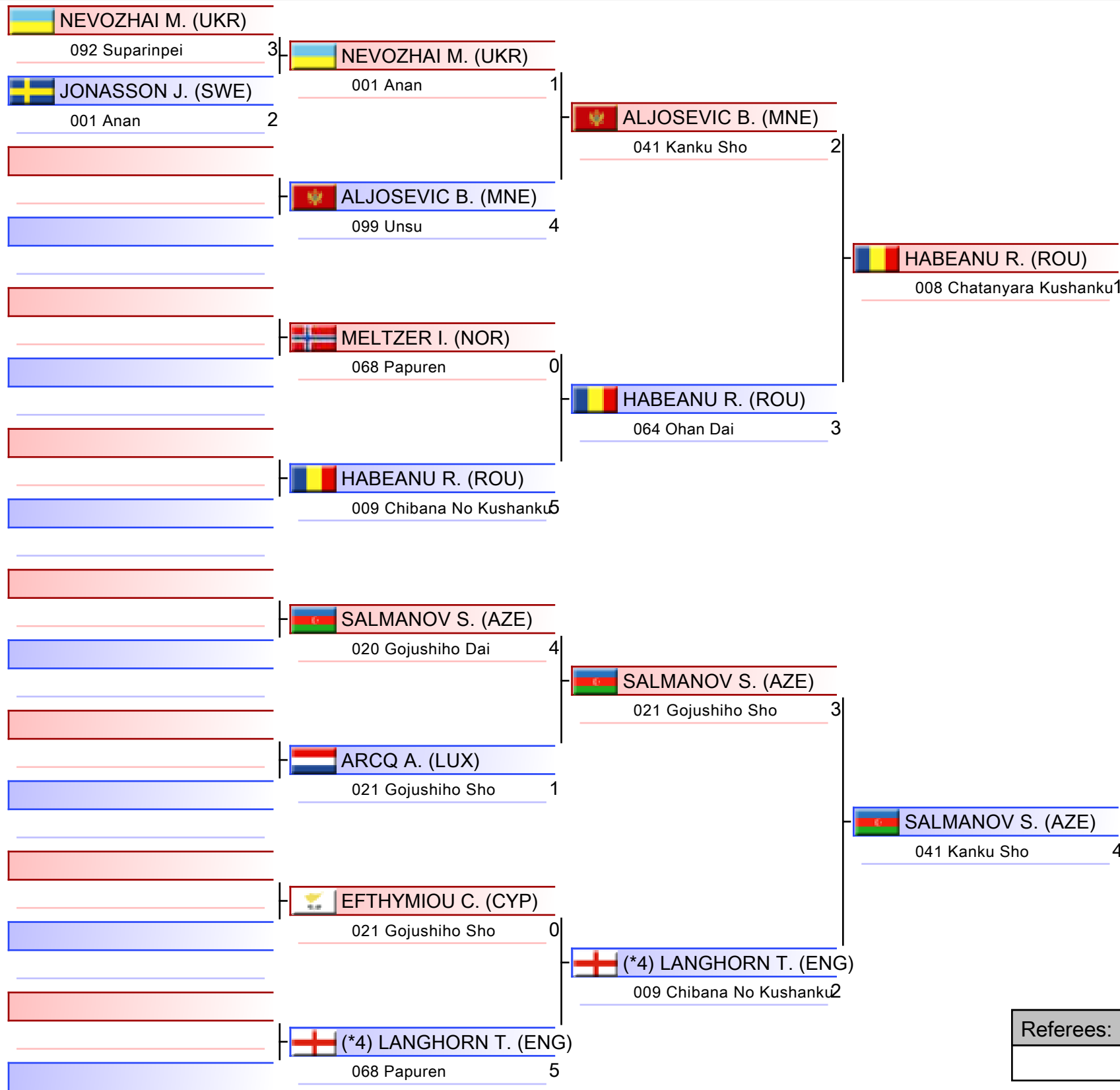

WKF
EUROPE

SALMANOV S. (AZE)

1. MATEUS VASCO (POR)
2. LEON DE LA PENA JOSE ANGEL (ESP)
3. KLEML THOMAS (FRA)
3. SALMANOV SALMAN (AZE)
5. BRZOBHATY MICHAL (CZE)
5. MARCHESE LUCIO (ITA)
7. PETERSEN LUKAS MURAKAMI (DEN)
7. MAJOR EMMANUEL (WAL)

*Seeded

Referees:			

Junior Kata Male

EKF Junior, Cadet & U21 Championships 2026 - Limassol, Spyros Kyprianou Athletic Center, Limassol, CYP

2026-02-06

Tatami
4 10:00

Pool
4/4



WKF
EUROPE

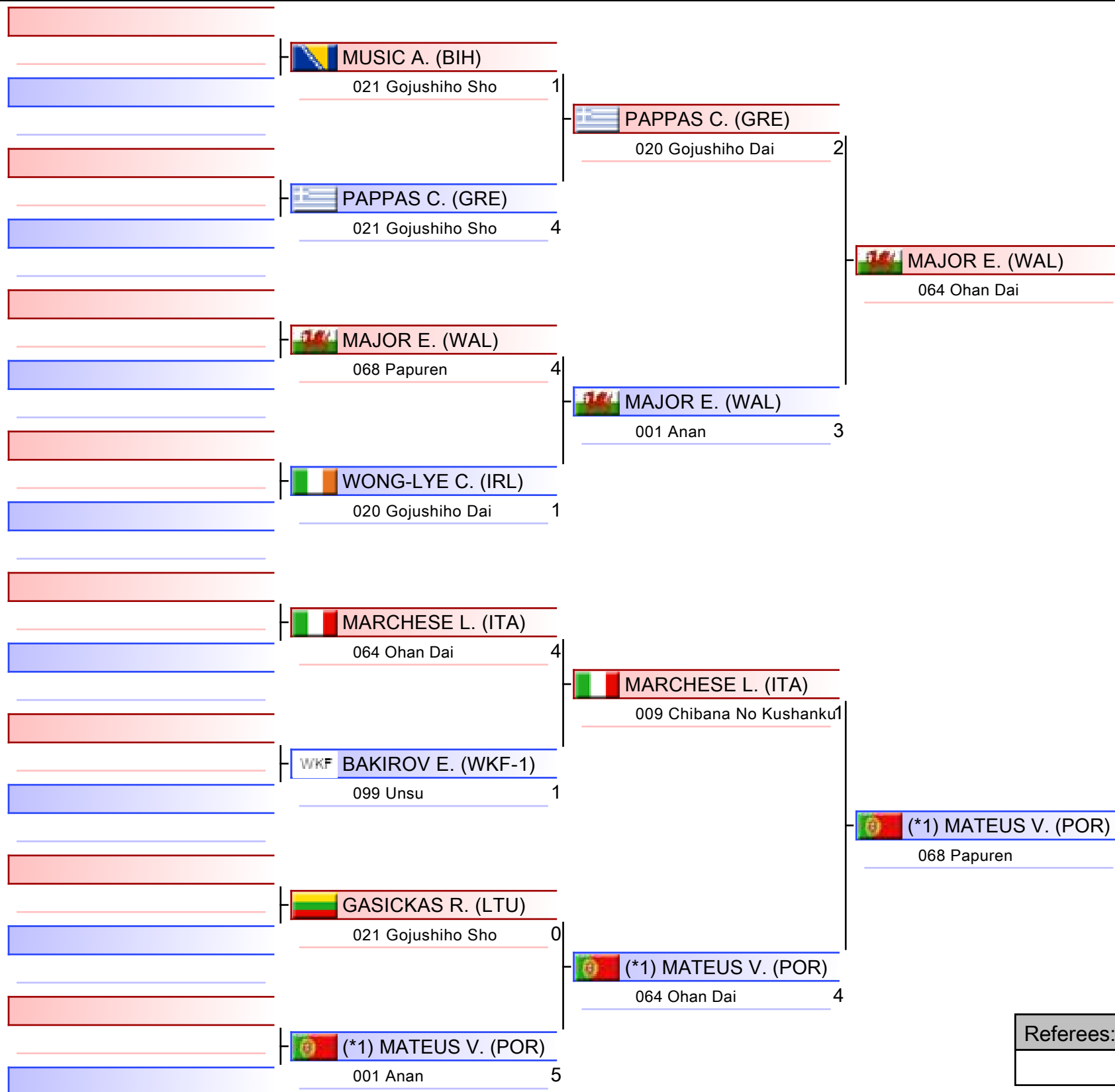

(*1) MATEUS V. (POR)

1. MATEUS VASCO (POR)
2. LEON DE LA PENA JOSE ANGEL (ESP)
3. KLEMZ THOMAS (FRA)
3. SALMANOV SALMAN (AZE)
5. BRZOBOHATY MICHAL (CZE)
5. MARCHESE LUCIO (ITA)
7. PETERSEN LUKAS MURAKAMI (DEN)
7. MAJOR EMMANUEL (WAL)

*Seeded

Referees:			

Pool winner-Junior Kata Male

EKF Junior, Cadet & U21 Championships 2026 - Limassol, Spyros Kyprianou Athletic Center, Limassol, CYP

2026-02-06

Tatami
2 11:05

Pool
1/1



WKF
EUROPE

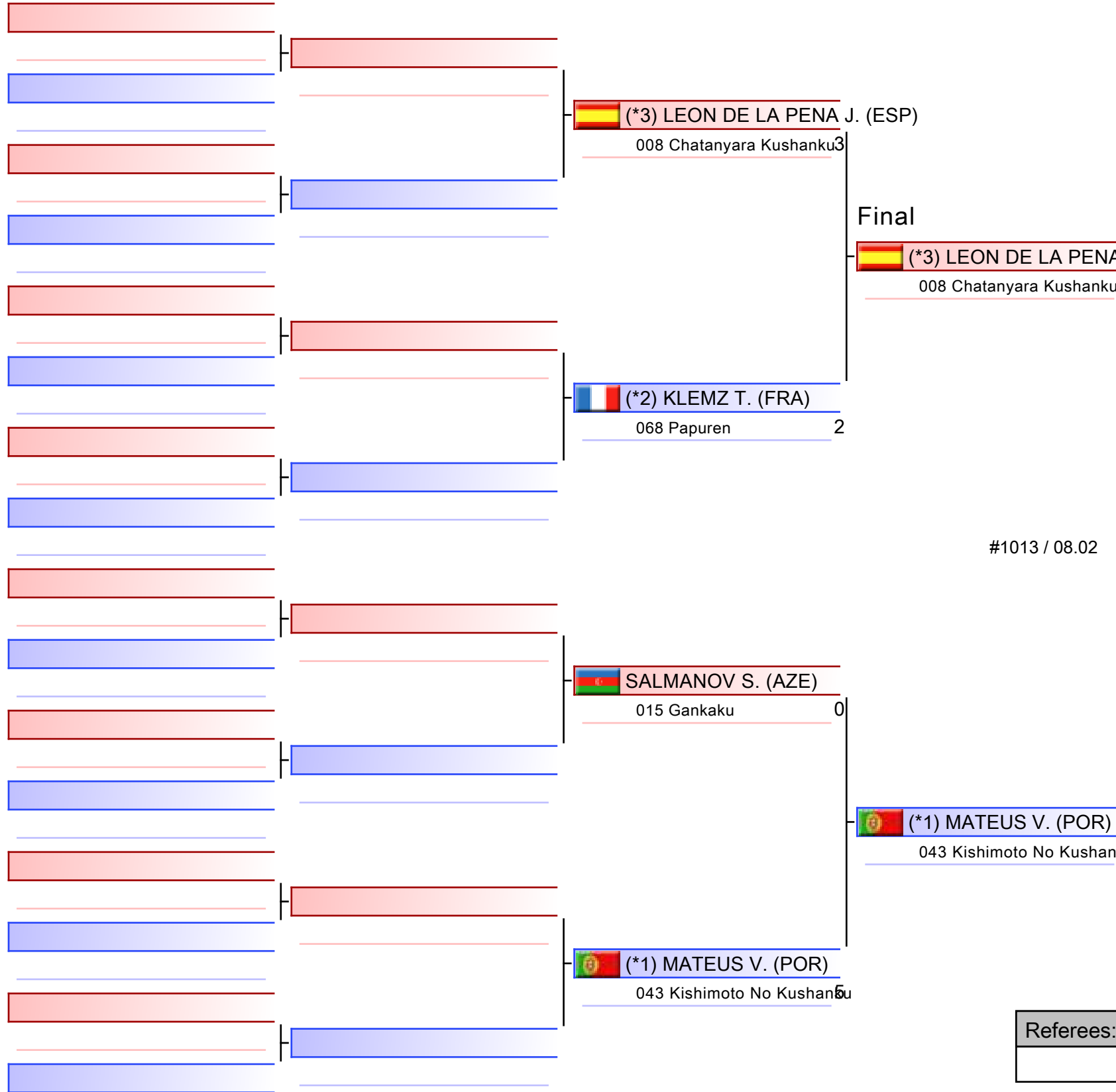

1. MATEUS VASCO (POR)
2. LEON DE LA PENA JOSE ANGEL (ESP)
3. KLEMZ THOMAS (FRA)
3. SALMANOV SALMAN (AZE)
5. BRZOBHATY MICHAL (CZE)
5. MARCHESE LUCIO (ITA)
7. PETERSEN LUKAS MURAKAMI (DEN)
7. MAJOR EMMANUEL (WAL)

*Seeded

Referees:			

Junior Kata Male

EKF Junior, Cadet & U21 Championships 2026 - Limassol

2026-02-06

Tatami

4 12:05

Pool

1,2,3,4

(c)sportdata GmbH & Co KG 2000-2026 (2026-02-08 17:46) v 11.0.0 build 2 (2025-01-21 11:49 CET) License: SDIL TWG2025 (expire 2026-09-30)

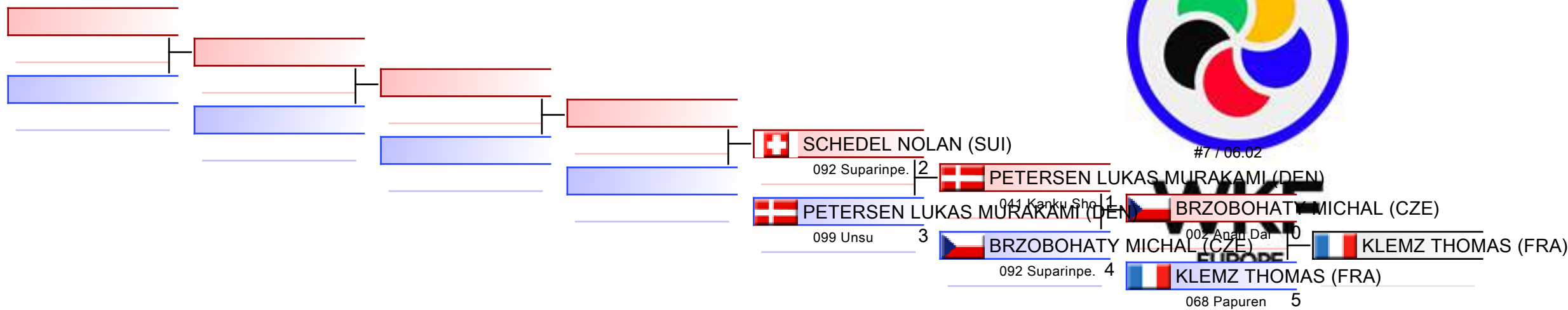

REPECHAGE: (1,2,3,4)

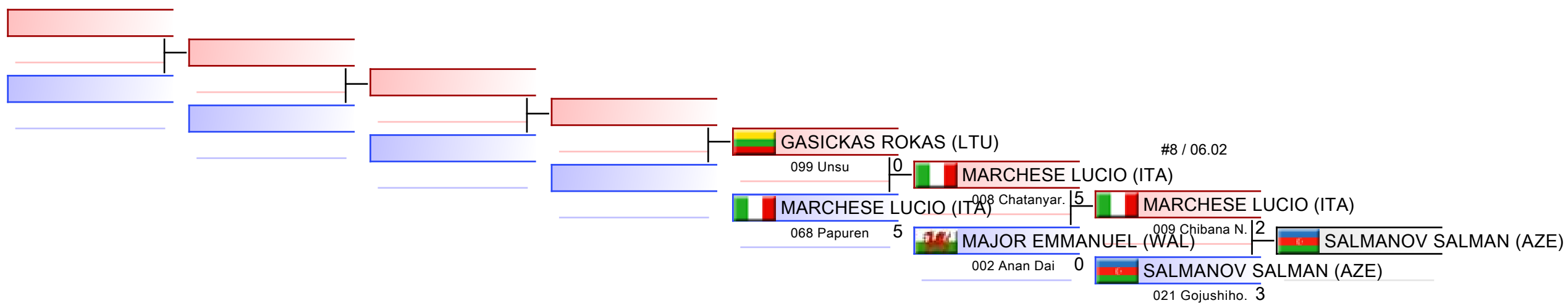

Referees:							
-----------	--	--	--	--	--	--	--



EKF Junior, Cadet & U21 Championships
2026 - Limassol - 2026-02-06



Official Results

Junior Kata Male			
1	MATEUS VASCO		POR - PORTUGAL
2	LEON DE LA PENNA JOSE ANGEL		ESP - SPAIN
3	KLEMZ THOMAS		FRA - FRANCE
3	SALMANOV SALMAN		AZE - AZERBAIJAN
5	BRZOBOHATY MICHAL		CZE - CZECH REPUBLIC
5	MARCHESE LUCIO		ITA - ITALY
7	PETERSEN LUKAS MURAKAMI		DEN - DENMARK
7	MAJOR EMMANUEL		WAL - WALES
9	SCHEDDEL NOLAN		SUI - SWITZERLAND
9	GASICKAS ROKAS		LTU - LITHUANIA

JUNIOR KUMITE FEMALE -48 KG



EKF Junior, Cadet & U21 Championships 2026 - Lim..



ENTRIES BY WEIGHT CATEGORY

Junior Kumite Female -48 kg

As of 8 FEB 2026

Code	ID	Gender	Name	Seeding
AZE	AZE03348	F	ZEYNALOVA MIRANA	
BEL	BEL02896	F	YUKSEKTEPE ASYA	
BIH	BIH03166	F	ZUKIC ADNA	
BUL	BUL003170	F	DONCHEVA GABRIELA	
CRO	CRO03494	F	BESLIJA ELENA	
CYP	CYP02829	F	EFSTATHIOU KONSTANTINA	3
ENG	ENG003389	F	CHANGER ANNABEL	
ESP	ESP003969	F	PACHECO PALOMARES MARIA	
FIN	FIN002861	F	HANNU ALVA	
FRA	FRA04091	F	KOUME LEE-LOU	1
GER	GER03796	F	DREWES LEYLA	
GRE	GRE03419	F	KOMINI ILIANA	
HUN	HUN003329	F	HEFNER ZSOFIA AGNES	
ISR	ISR003099	F	COHEN ELLA	
ITA	ITA05402	F	CAPATTI GIADA	
LAT	LAT02714	F	KONAJEVA JEVGENIJA	
LUX	LUX02658	F	TERLICA GOMES OCEANE	
MKD	MKD02995	F	JORDANOSKI MARIJA	
MNE	MNE03196	F	PERKOVIC TARA	
POL	POL3244	F	MELLER ADRIANNA	
POR	POR003362	F	MATOS ISIS	4
ROU	ROU03737	F	BAICU LORENA MARINA	
SRB	SRB004836	F	STEVANOVIC ANJA	
SUI	SUI03111	F	OEZDEMIR DEMET	
SVK	SVK03009	F	MIERNA ADRIANA	
UKR	UKR003728	F	KOTENKO VIERONIKA	2
WKF-1	WKF-1006799	F	LEONOVA VARVARA	

Junior Kumite Female -48 kg

EKF Junior, Cadet & U21 Championships 2026 - Limassol, Spyros Kyprianou Athletic Center, Limassol, CYP

2026-02-07

Tatami
1 10:15

Pool
1/4

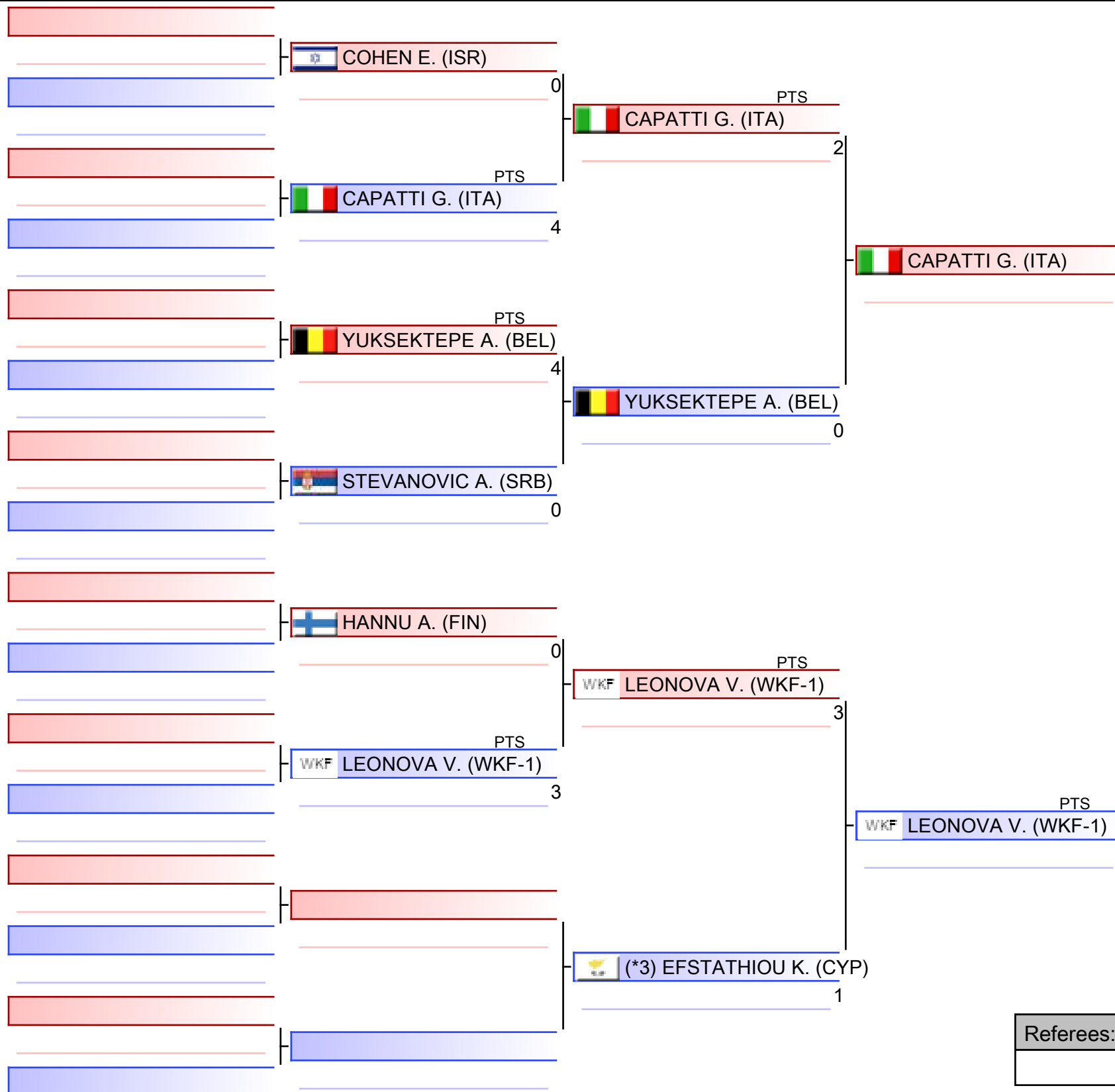

WKF
EUROPE

WKF LEONOVA V. (WKF-1)

1. KOMINI ILIANA (GRE)
2. KOTENKO VIERONIKA (UKR)
3. KONAJEVA JEVGENIJA (LAT)
3. MIERNA ADRIANA (SVK)
5. LEONOVA VARVARA (WKF-1)
5. MATOS ISIS (POR)
7. BESLIJA ELENA (CRO)
7. ZUKIC ADNA (BIH)

*Seeded

Referees:			

Junior Kumite Female -48 kg

EKF Junior, Cadet & U21 Championships 2026 - Limassol, Spyros Kyprianou Athletic Center, Limassol, CYP

2026-02-07

Tatami
1 10:50

Pool
2/4



WKF
EUROPE

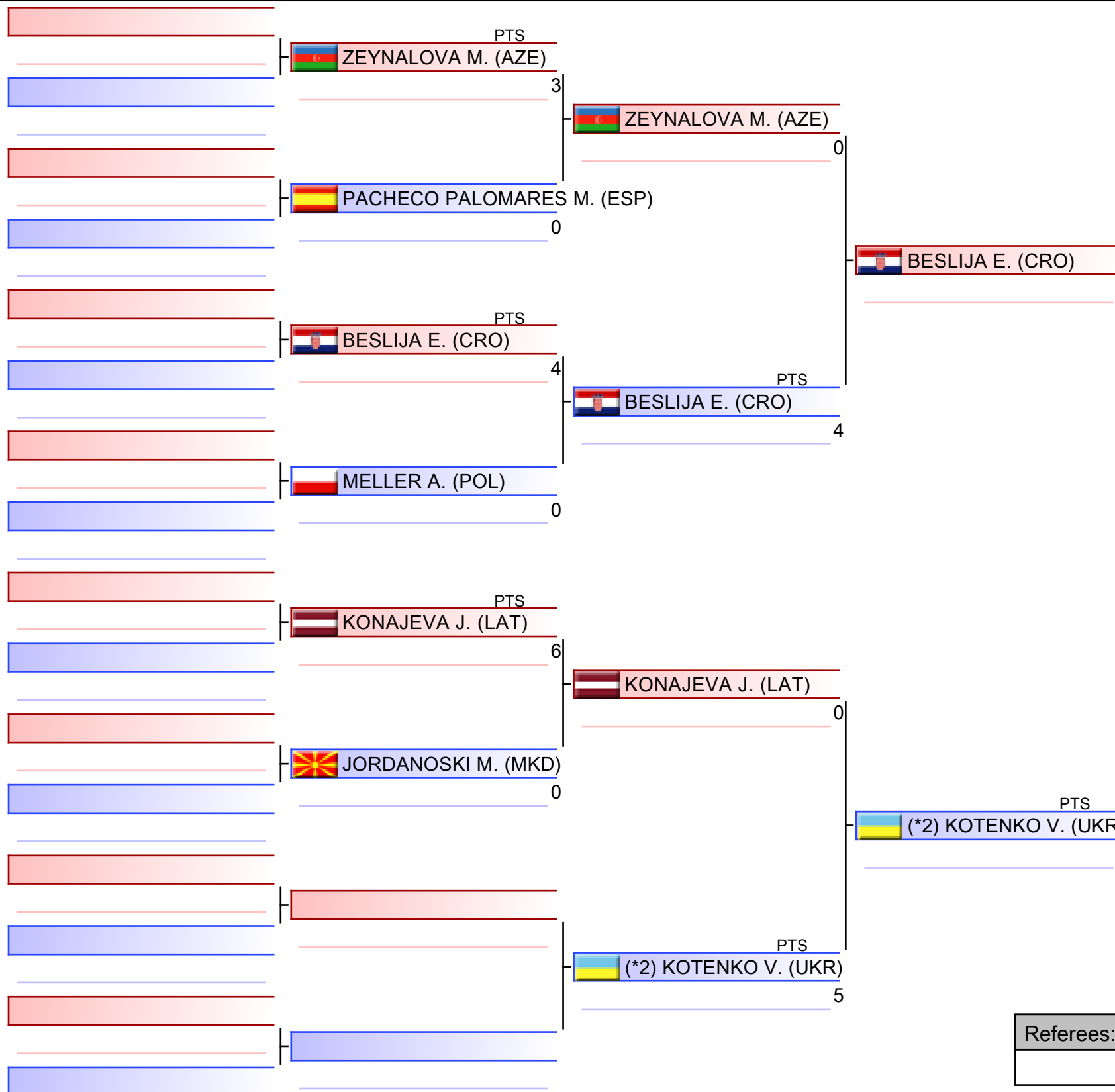

(*2) KOTENKO V. (UKR)

1. KOMINI ILIANA (GRE)
2. KOTENKO VIERONIKA (UKR)
3. KONAJEVA JEVGENIJA (LAT)
3. MIERNA ADRIANA (SVK)
5. LEONOVA VARVARA (WKF-1)
5. MATOS ISIS (POR)
7. BESLIJA ELENA (CRO)
7. ZUKIC ADNA (BIH)

*Seeded

Referees:			

Junior Kumite Female -48 kg

EKF Junior, Cadet & U21 Championships 2026 - Limassol, Spyros Kyprianou Athletic Center, Limassol, CYP

2026-02-07

Tatami
2 10:15

Pool
3/4



WKF
EUROPE

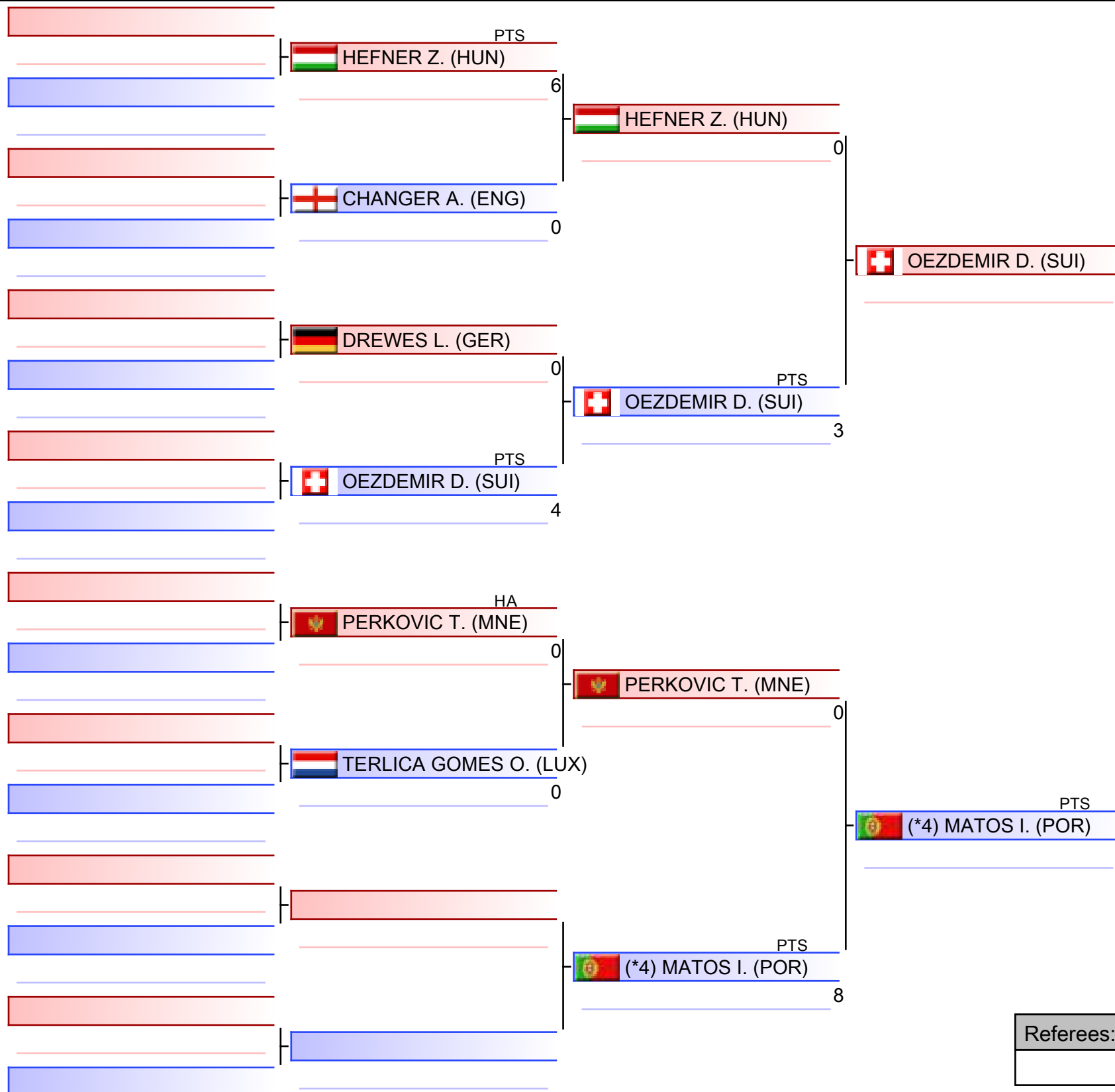

(*4) MATOS I. (POR)

1. KOMINI ILIANA (GRE)
2. KOTENKO VIERONIKA (UKR)
3. KONAJEVA JEVGENIJA (LAT)
3. MIERNA ADRIANA (SVK)
5. LEONOVA VARVARA (WKF-1)
5. MATOS ISIS (POR)
7. BESLIJA ELENA (CRO)
7. ZUKIC ADNA (BIH)

*Seeded

Referees:			

Junior Kumite Female -48 kg

EKF Junior, Cadet & U21 Championships 2026 - Limassol, Spyros Kyprianou Athletic Center, Limassol, CYP

2026-02-07

Tatami
2 10:50

Pool
4/4



WKF
EUROPE

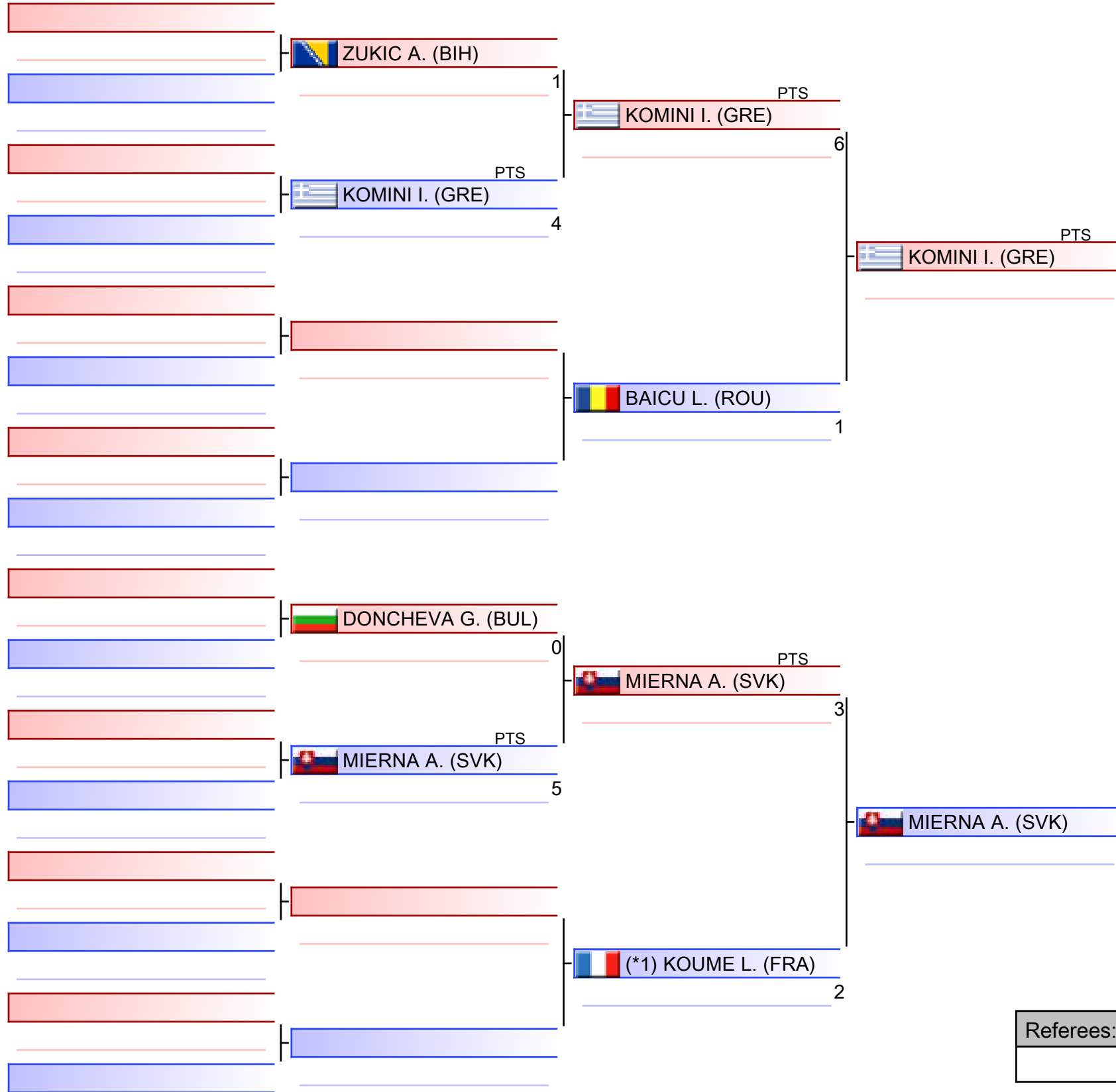

1. KOMINI ILIANA (GRE)
2. KOTENKO VIERONIKA (UKR)
3. KONAJEVA JEVGENIJA (LAT)
3. MIERNA ADRIANA (SVK)
5. LEONOVA VARVARA (WKF-1)
5. MATOS ISIS (POR)
7. BESLIJA ELENA (CRO)
7. ZUKIC ADNA (BIH)

*Seeded

Referees:			

Pool winner-Junior Kumite Female -48 kg

EKF Junior, Cadet & U21 Championships 2026 - Limassol, Spyros Kyprianou Athletic Center, Limsassol, CYP

2026-02-07

Tatami
1 11:25

Pool
1/1

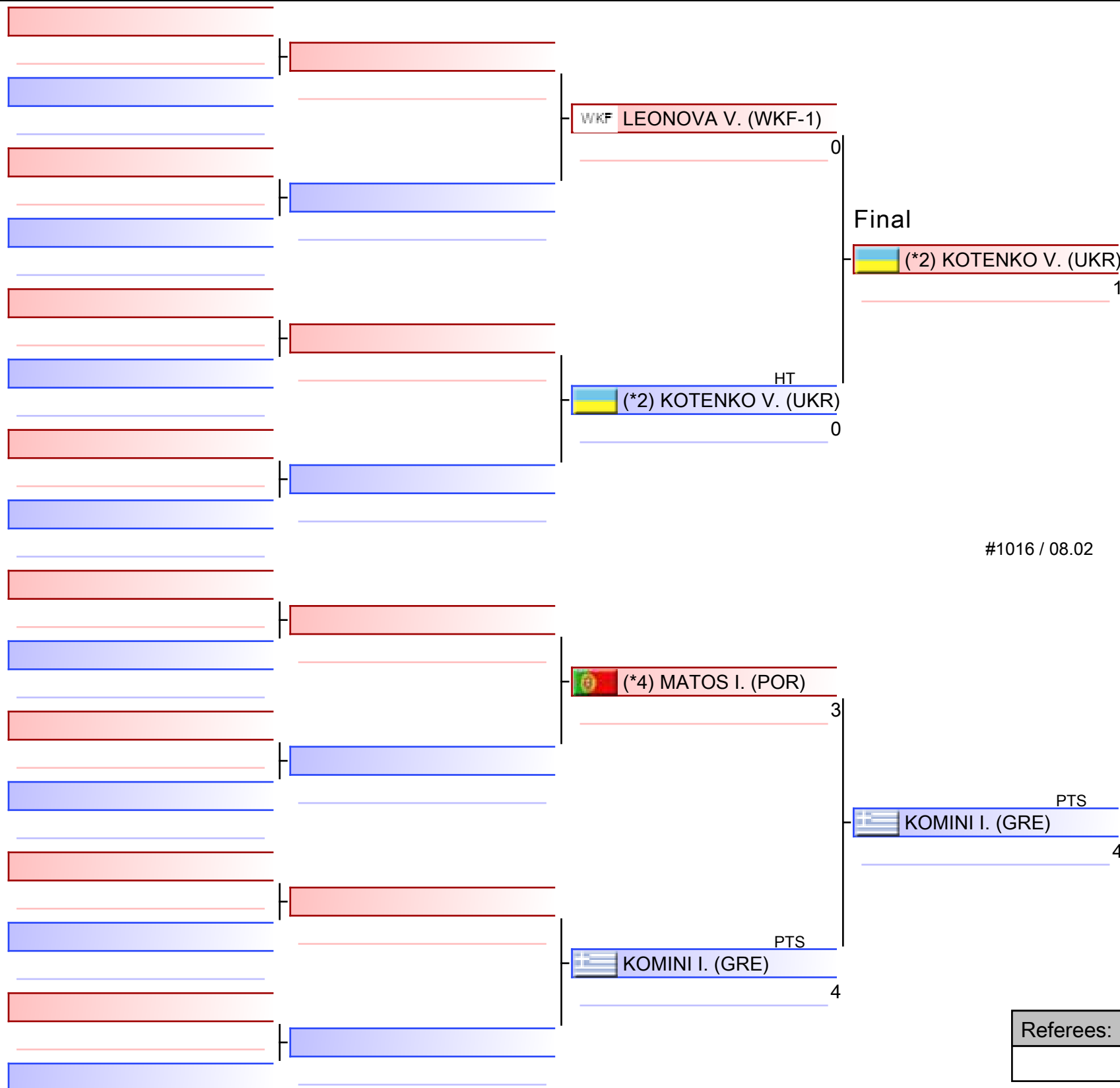

1. KOMINI ILIANA (GRE)
2. KOTENKO VIERONIKA (UKR)
3. KONAJEVA JEVGENIJA (LAT)
3. MIERNA ADRIANA (SVK)
5. LEONOVA VARVARA (WKF-1)
5. MATOS ISIS (POR)
7. BESLIJA ELENA (CRO)
7. ZUKIC ADNA (BIH)

*Seeded

Referees:			

Junior Kumite Female -48 kg

EKF Junior, Cadet & U21 Championships 2026 - Limassol

2026-02-07

Tatami

2 17:10

Pool

1,2,3,4

(c)sportdata GmbH & Co KG 2000-2026 (2026-02-08 17:46) v 11.0.0 build 2 (2025-01-21 11:49 CET) License: SDIL TWG2025 (expire 2026-09-30)

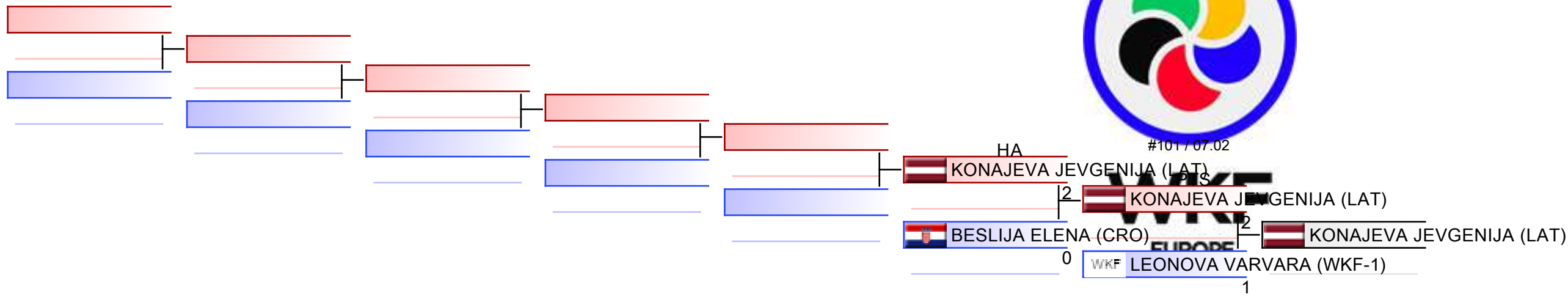

REPECHAGE: (1,2,3,4)

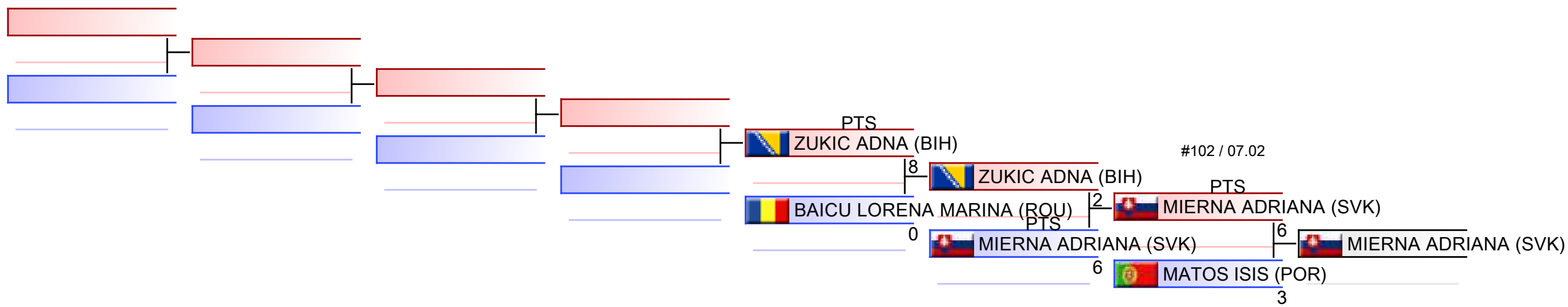

Referees:							
-----------	--	--	--	--	--	--	--



EKF Junior, Cadet & U21 Championships
2026 - Limassol - 2026-02-06



Official Results

Junior Kumite Female -48 kg			
1	KOMINI ILIANA		GRE - GREECE
2	KOTENKO VIERONIKA		UKR - UKRAINE
3	KONAJEVA JEVGENIJA		LAT - LATVIA
3	MIERNA ADRIANA		SVK - SLOVAKIA
5	LEONOVA VARVARA		WKF-1 - WKF-1
5	MATOS ISIS		POR - PORTUGAL
7	BESLIJA ELENA		CRO - CROATIA
7	ZUKIC ADNA		BIH - BOSNIA AND HERZEGOVINA
9	BAICU LORENA MARINA		ROU - ROMANIA

JUNIOR KUMITE FEMALE -53 KG



EKF Junior, Cadet & U21 Championships 2026 - Lim..



ENTRIES BY WEIGHT CATEGORY

Junior Kumite Female -53 kg

As of 8 FEB 2026

Code	ID	Gender	Name	Seeding
AUT	AUT03002	F	KIRISITS MIRA	
AZE	AZE02691	F	MAMMADOVA FATIMA	
BIH	BIH03989	F	DOGATOVIC TAMARA	
BUL	BUL02974	F	KONDOVA MARINA	
CRO	CRO03367	F	BRLETIC ELENA	
CYP	CYP02840	F	DALITI IOULIA	
DEN	DEN003041	F	LY ISABELLA	
ENG	ENG003610	F	MORAN EMILY	
ESP	ESP004415	F	AYERDI ARIZ NAROA	
EST	EST002775	F	AIGRO MARI	
FIN	FIN002719	F	ITKONEN JANIKA	
FRA	FRA004452	F	RUIZ ORIANE	
GER	GER003876	F	GOTTSCHALK EMMA	
GRE	GRE004268	F	ZEZAI MARINA	
HUN	HUN02867	F	TOROK PANKA	
IRL	IRL003212	F	BYRNE ELLA	
ISR	ISR02860	F	IASKOV TATIANA	
ITA	ITA05403	F	CAPONE BIANCA	4
LAT	LAT02518	F	PUISANE LAUMA	
LUX	LUX02651	F	COQUILLARD ELISE	
MKD	MKD03022	F	BRESLIEVA DUSICA	
MNE	MNE03192	F	VUKCEVIC LANA	
POR	POR03182	F	GONCALVES LEONOR	1
ROU	ROU003956	F	SOFIA GHINIA	
SRB	SRB02988	F	BANKOVIC DANICA	
SUI	SUI03112	F	DUMITRAS PIA	
SVK	SVK03128	F	ILAVSKA KRISTINA	
UKR	UKR03561	F	HNES MARIIA	2
WKF-1	AIN-1006413	F	GASHNIKOVA VERONIKA	3

Junior Kumite Female -53 kg

EKF Junior, Cadet & U21 Championships 2026 - Limassol, Spyros Kyprianou Athletic Center, Limassol, CYP

2026-02-07

Tatami
3 10:15

Pool
1/4

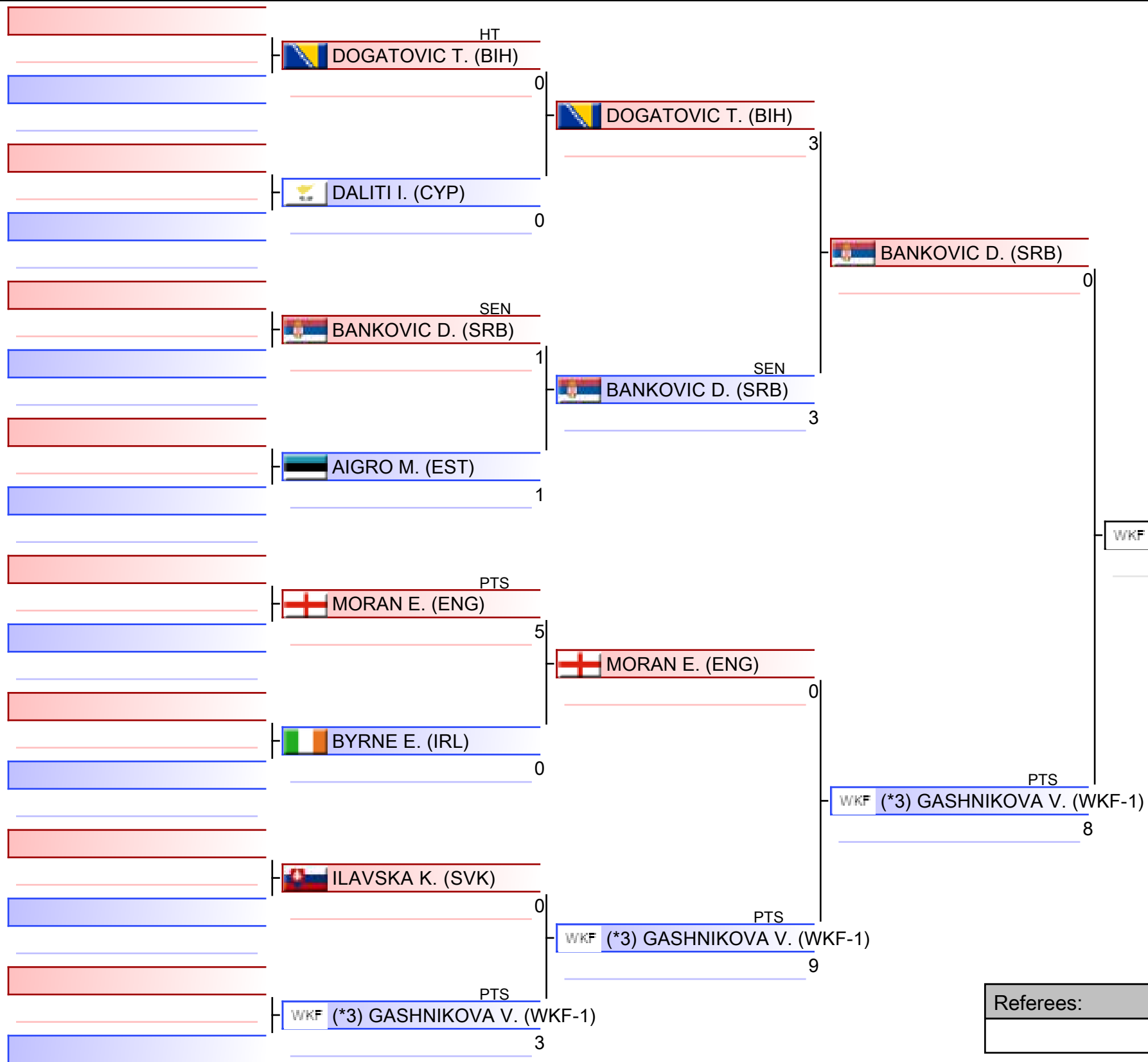

WKF (*3) GASHNIKOVA V. (WKF-1)

1. GASHNIKOVA VERONIKA (WKF-1)
2. GONCALVES LEONOR (POR)
3. HNES MARIIA (UKR)
3. TOROK PANKA (HUN)
5. ILAVSKA KRISTINA (SVK)
5. AYERDI ARIZ NAROA (ESP)
7. BANKOVIC DANICA (SRB)
7. MAMMADOVA FATIMA (AZE)

*Seeded

Referees:			

Junior Kumite Female -53 kg

EKF Junior, Cadet & U21 Championships 2026 - Limassol, Spyros Kyprianou Athletic Center, Limassol, CYP

2026-02-07

Tatami
3 10:55

Pool
2/4



WKF
EUROPE

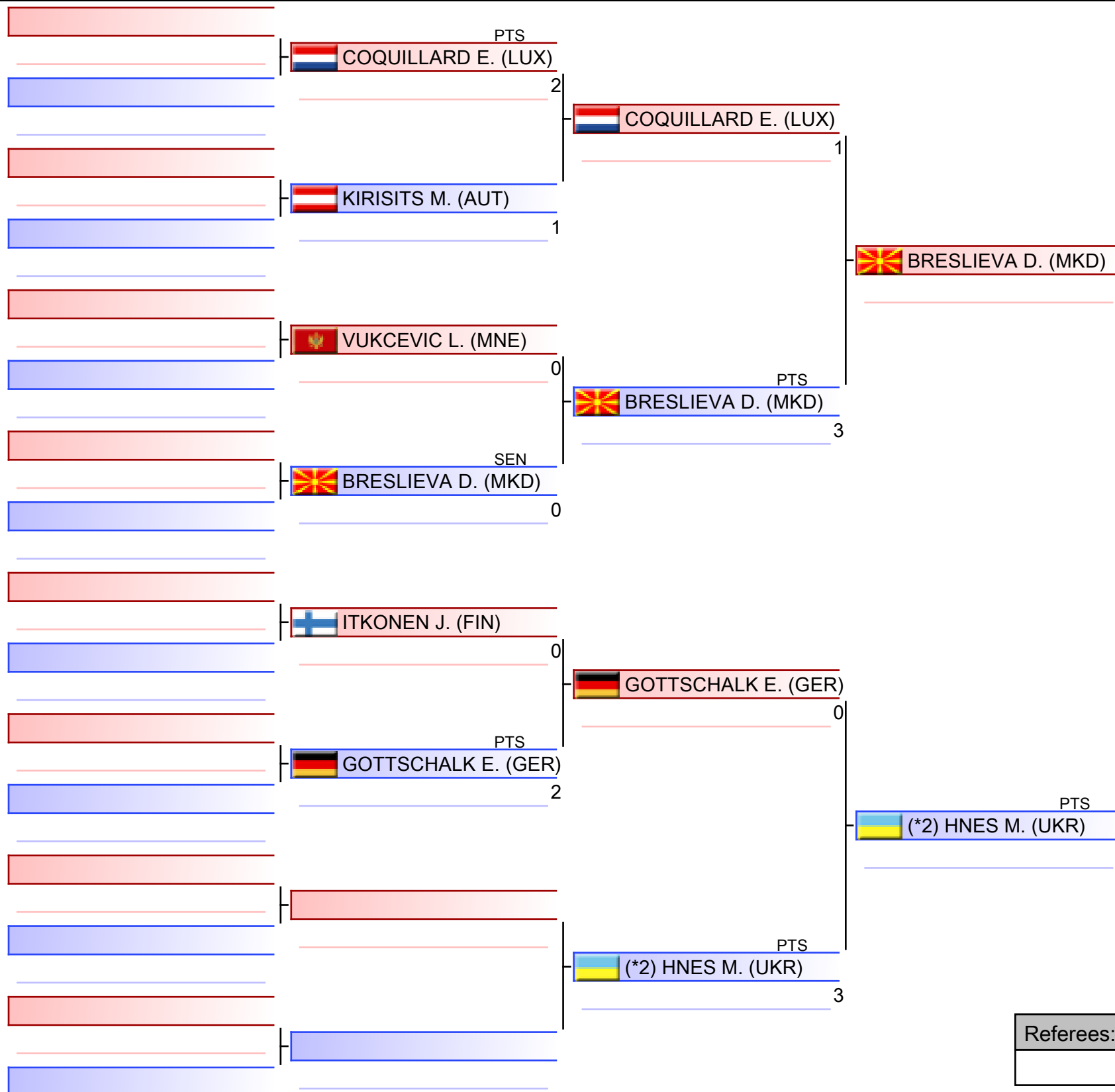

(*2) HNES M. (UKR)

1. GASHNIKOVA VERONIKA (WKF-1)
2. GONCALVES LEONOR (POR)
3. HNES MARIIA (UKR)
3. TOROK PANKA (HUN)
5. ILAVSKA KRISTINA (SVK)
5. AYERDI ARIZ NAROA (ESP)
7. BANKOVIC DANICA (SRB)
7. MAMMADOVA FATIMA (AZE)

*Seeded

Referees:			

Junior Kumite Female -53 kg

EKF Junior, Cadet & U21 Championships 2026 - Limassol, Spyros Kyprianou Athletic Center, Limassol, CYP

2026-02-07

Tatami
4 10:15

Pool
3/4



WKF
EUROPE

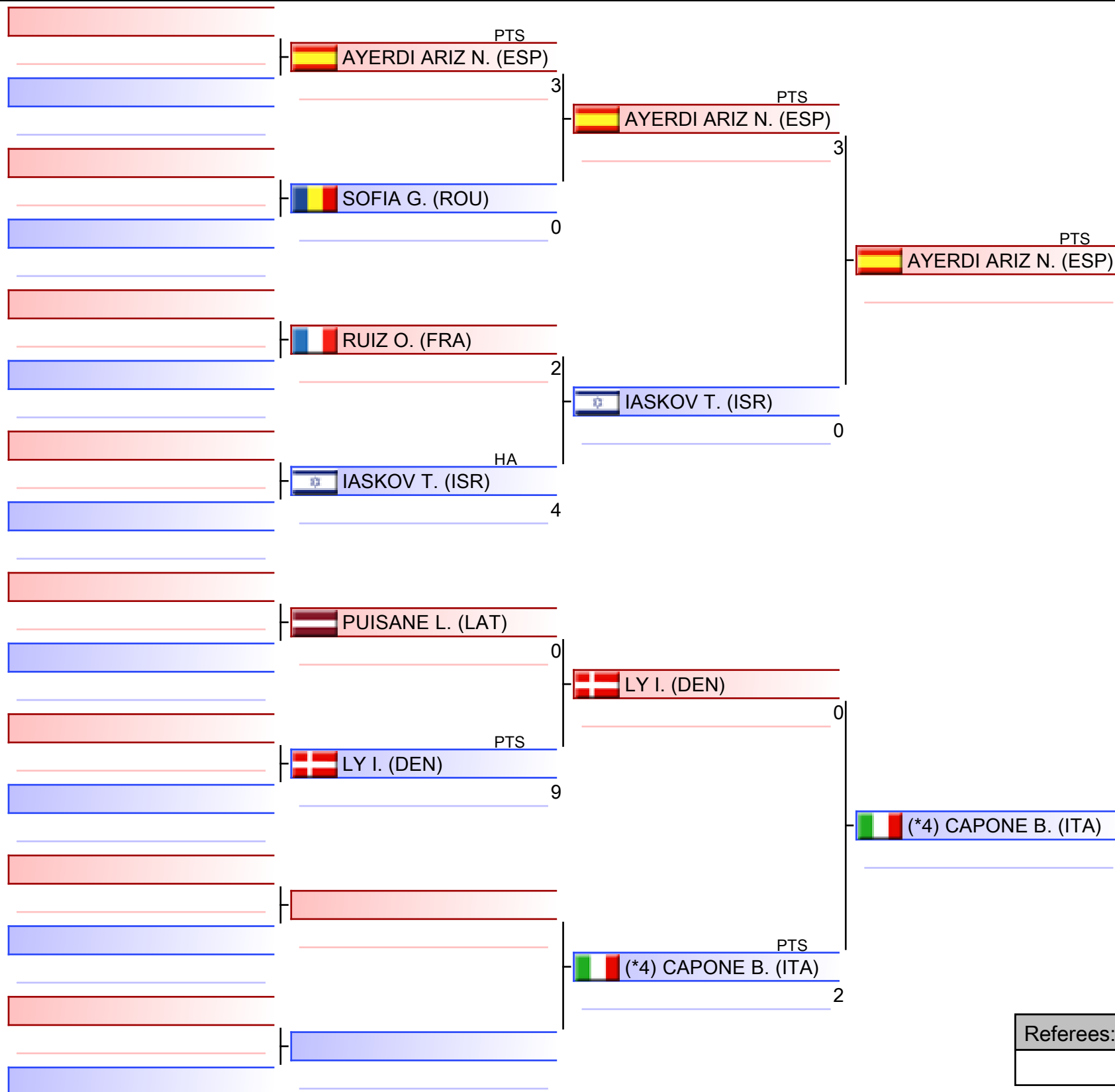

AYERDI ARIZ N. (ESP)

1. GASHNIKOVA VERONIKA (WKF-1)
2. GONCALVES LEONOR (POR)
3. HNES MARIIA (UKR)
3. TOROK PANKA (HUN)
5. ILAVSKA KRISTINA (SVK)
5. AYERDI ARIZ NAROA (ESP)
7. BANKOVIC DANICA (SRB)
7. MAMMADOVA FATIMA (AZE)

*Seeded

Referees:			

Junior Kumite Female -53 kg

EKF Junior, Cadet & U21 Championships 2026 - Limassol, Spyros Kyprianou Athletic Center, Limassol, CYP

2026-02-07

Tatami
4 10:50

Pool
4/4



WKF
EUROPE

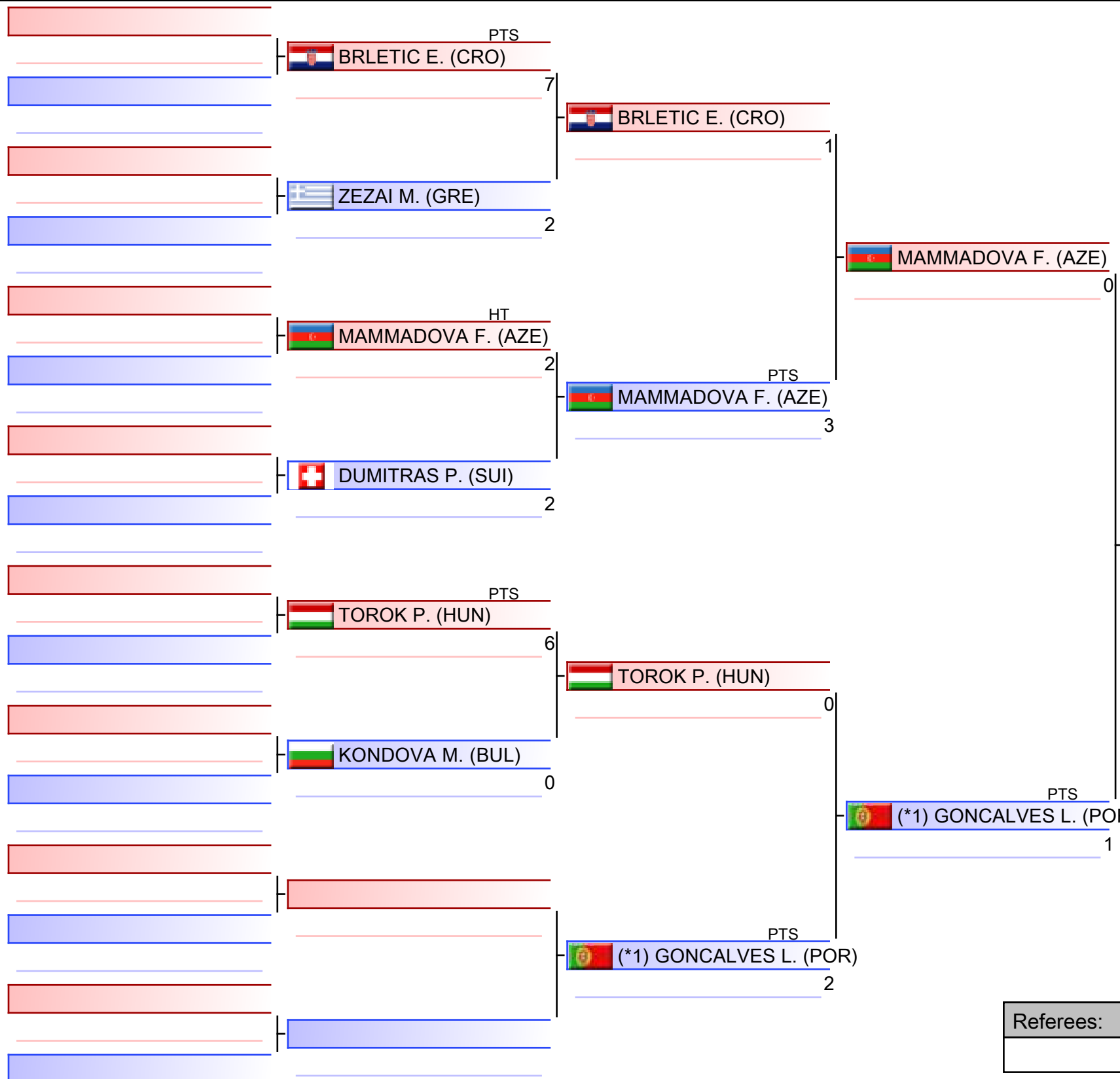

(*1) GONCALVES L. (POR)

1. GASHNIKOVA VERONIKA (WKF-1)
2. GONCALVES LEONOR (POR)
3. HNES MARIIA (UKR)
3. TOROK PANKA (HUN)
5. ILAVSKA KRISTINA (SVK)
5. AYERDI ARIZ NAROA (ESP)
7. BANKOVIC DANICA (SRB)
7. MAMMADOVA FATIMA (AZE)

*Seeded

Referees:			

Pool winner-Junior Kumite Female -53 kg

EKF Junior, Cadet & U21 Championships 2026 - Limassol, Spyros Kyprianou Athletic Center, Limsassol, CYP

2026-02-07

Tatami
3 11:30

Pool
1/1

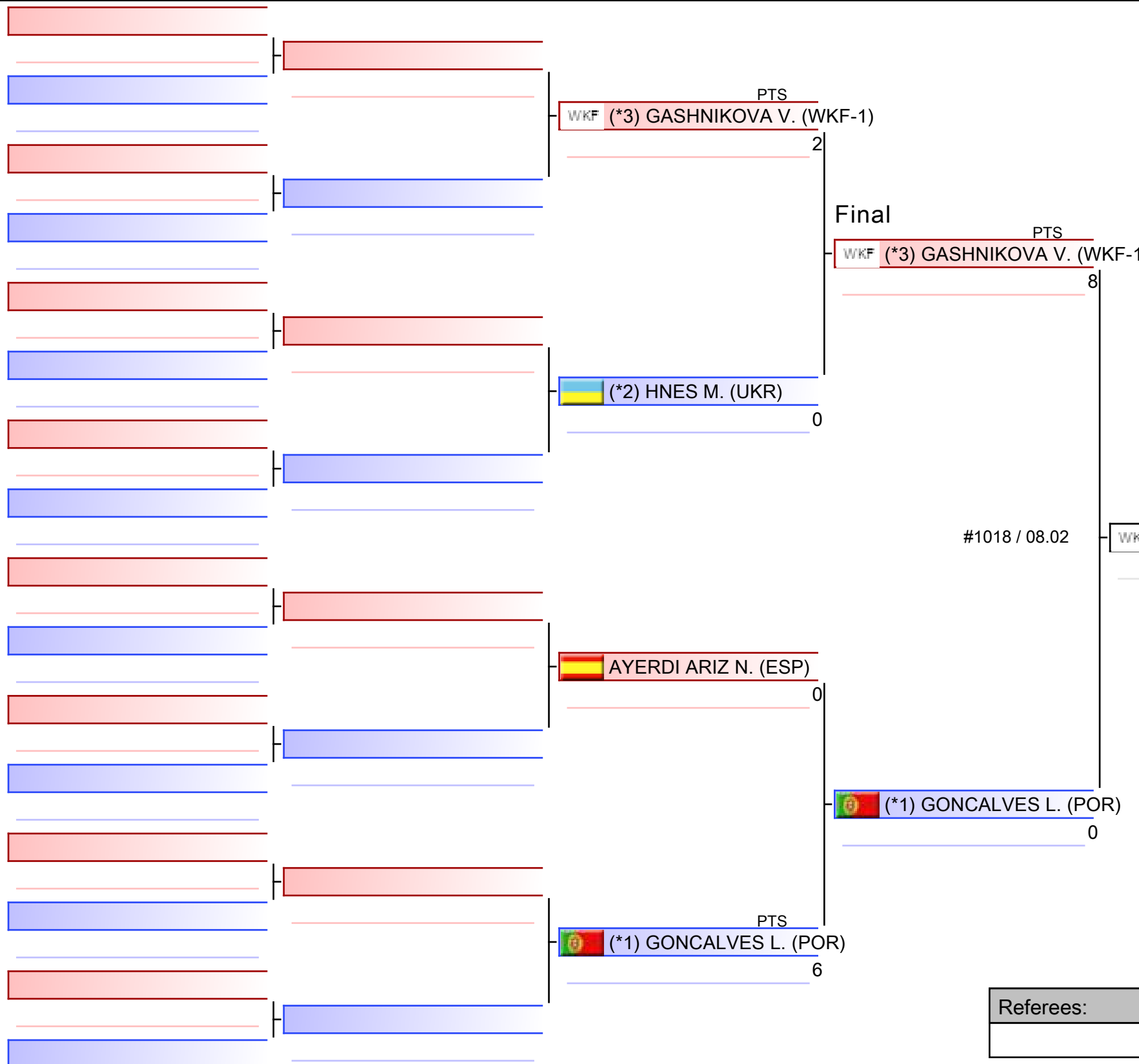

1. GASHNIKOVA VERONIKA (WKF-1)
2. GONCALVES LEONOR (POR)
3. HNES MARIA (UKR)
3. TOROK PANKA (HUN)
5. ILAVSKA KRISTINA (SVK)
5. AYERDI ARIZ NAROA (ESP)
7. BANKOVIC DANICA (SRB)
7. MAMMADOVA FATIMA (AZE)

*Seeded

Referees:			

Junior Kumite Female -53 kg

EKF Junior, Cadet & U21 Championships 2026 - Limassol

2026-02-07

Tatami

1 17:30

Pool

1,2,3,4

(c)sportdata GmbH & Co KG 2000-2026 (2026-02-08 17:46) v 11.0.0 build 2 (2025-01-21 11:49 CET) License: SDIL TWG2025 (expire 2026-09-30)

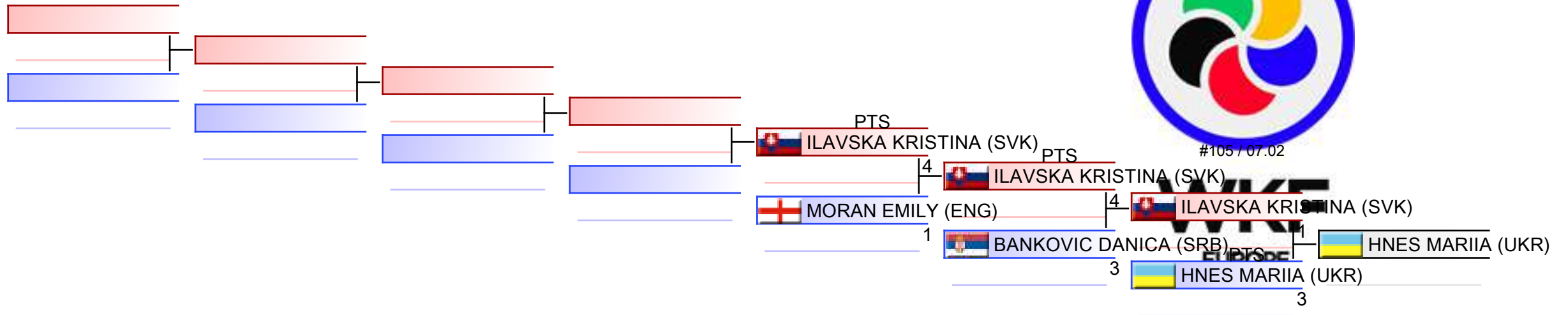

REPECHAGE: (1,2,3,4)

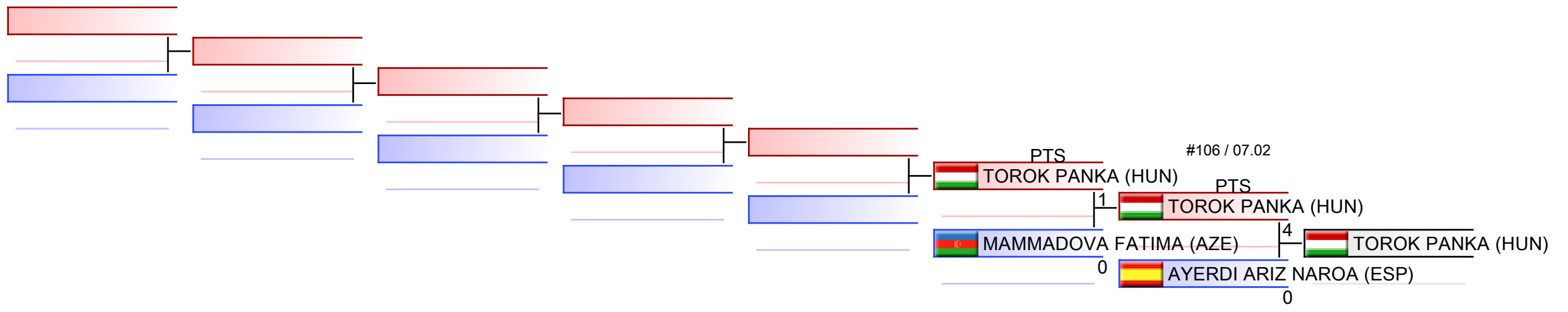

Referees:							
-----------	--	--	--	--	--	--	--



EKF Junior, Cadet & U21 Championships
2026 - Limassol - 2026-02-06



Official Results

Junior Kumite Female -53 kg			
1	GASHNIKOVA VERONIKA		WKF-1 - WKF-1
2	GONCALVES LEONOR		POR - PORTUGAL
3	HNES MARIIA		UKR - UKRAINE
3	TOROK PANKA		HUN - HUNGARY
5	ILAVSKA KRISTINA		SVK - SLOVAKIA
5	AYERDI ARIZ NAROA		ESP - SPAIN
7	BANKOVIC DANICA		SRB - SERBIA
7	MAMMADOVA FATIMA		AZE - AZERBAIJAN
9	MORAN EMILY		ENG - ENGLAND

JUNIOR KUMITE FEMALE -59 KG



EKF Junior, Cadet & U21 Championships 2026 - Lim..



ENTRIES BY WEIGHT CATEGORY

Junior Kumite Female -59 kg

As of 8 FEB 2026

Code	ID	Gender	Name	Seeding
ARM	ARM03014	F	DAVTYAN ALVARD	
AUT	AUT02817	F	CETIN CEYLIN	2
AZE	AZE003408	F	HAJIYEVA FATMA	
BIH	BIH2946	F	SIPOVIC EDINA	
BUL	BUL02459	F	BOYADZHIEVA ADRIANA	
CRO	CRO03381	F	BRAICA KATJA	
CYP	CYP02821	F	ARTEMI KONSTANTINA	
CZE	CZE003195	F	POSKEROVA NELA	
DEN	DEN002953	F	SOENDERGAARD HANNAH BATH	1
ENG	ENG03254	F	NARDELLI TALIA	4
ESP	ESP03884	F	GOMEZ MAURINO ALEJANDRA	
EST	EST002776	F	TEHVAND KADRI JOHANNA	
FRA	FRA004201	F	SCARFONE MORGANE	
GEO	GEO003028	F	LOMTADZE DARINA	
GER	GER03304	F	HELLEN ILI	
GRE		F	RESVANI VASILIKI	
HUN	HUN003514	F	ADAM ADRIENN	
IRL	IRL02943	F	REEN ASHA	
ISL	ISL02320	F	HALLDORSDDOTTIR EMBLA	
ISR	ISR003244	F	KRIKUN HADAR	
ITA	ITA005580	F	COCCA MARIALUIGIA	
LAT	LAT003011	F	JERMACONOKA NATALIJA	
LTU	LTU002739	F	BUTKUTE ANDREJA	
LUX	LUX02474	F	GAWELLEK SARAH	
MKD	MKD02697	F	EVTIMOVSKA DRAGANA	
MNE	MNE02633	F	DJUKIC KATARINA	3
NOR	NOR002832	F	OLSEN LINA-VIKTORIA SALES	
POL	POL3867	F	KRACZAJ WIKTORIA	
POR	POR03183	F	BAZYUK VICTORIA	
ROU	ROU02702	F	SULU KARINA MIHAELA	
SLO	SLO02690	F	KRVINA LIA	
SRB	SRB03831	F	RADOVIC IRINA	
SVK	SVK003247	F	BENESOVA NINA	
SWE	SWE003356	F	KHASHAN ILAF	
UKR	UKR03314	F	PUSHKOVA ANASTASIIA	
WAL	WAL002451	F	REES MAIDIE	
WKF-1	WKF-1006796	F	OCHIROVA SAGLARA	
WKF-2	AIN-2002792	F	LABATSEVICH ALINA	

Junior Kumite Female -59 kg

EKF Junior, Cadet & U21 Championships 2026 - Limassol, Spyros Kyprianou Athletic Center, Limassol, CYP

2026-02-07

Tatami
5 11:40

Pool
1/4

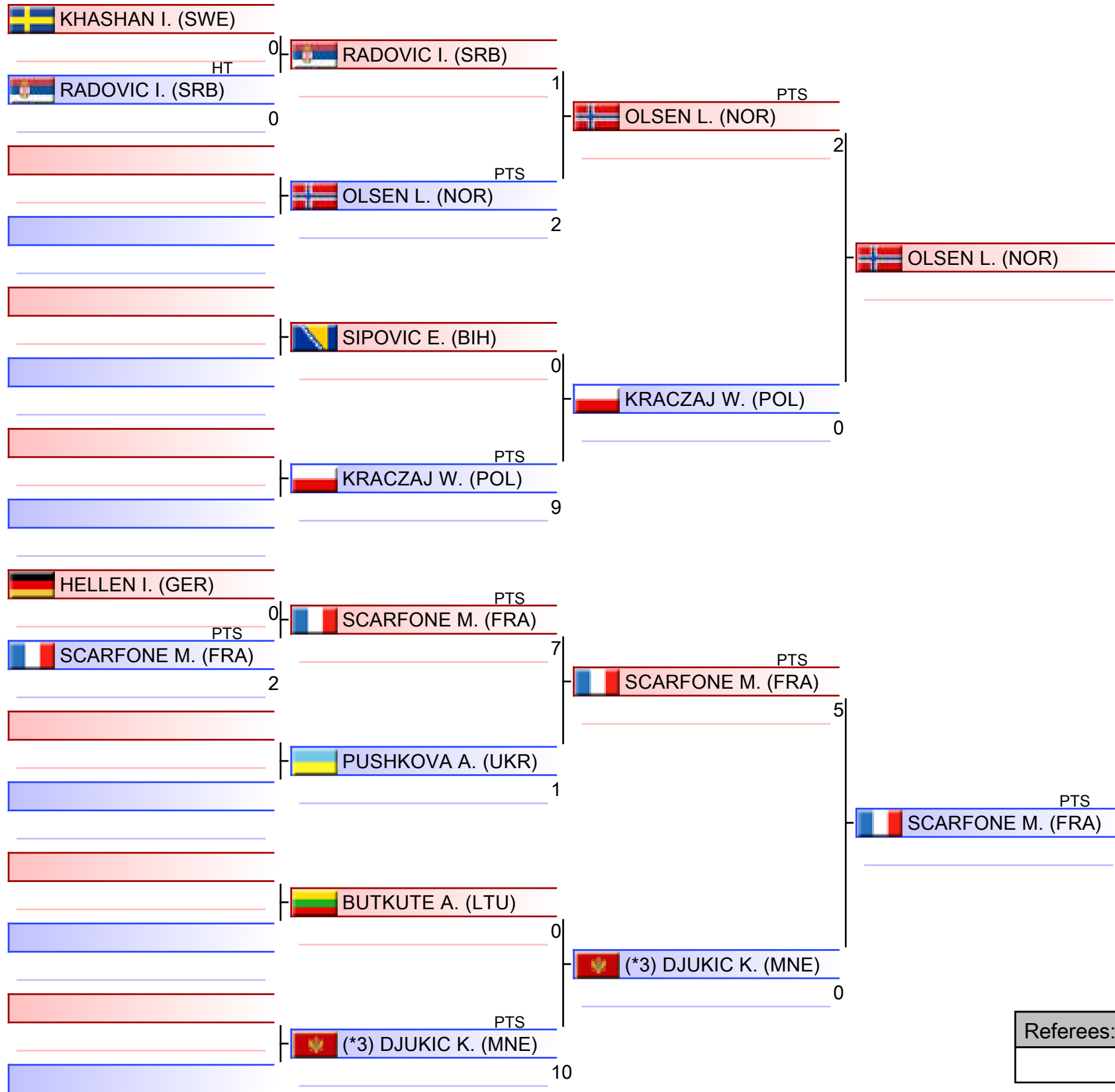

WKF
EUROPE

SCARFONE M. (FRA)

1. SOENDERGAARD HANNAH BATH (DEN)
2. SCARFONE MORGANE (FRA)
3. LABATSEVICH ALINA (WKF-2)
3. HELLEN ILI (GER)
5. BAZYUK VICTORIA (POR)
5. KRIVINA LIA (SLO)
7. BENESOVA NINA (SVK)
7. OLSEN LINA-VIKTORIA SALES (NOR)

*Seeded

Referees:			

Junior Kumite Female -59 kg

EKF Junior, Cadet & U21 Championships 2026 - Limassol, Spyros Kyprianou Athletic Center, Limassol, CYP

2026-02-07

Tatami
5 12:30

Pool
2/4

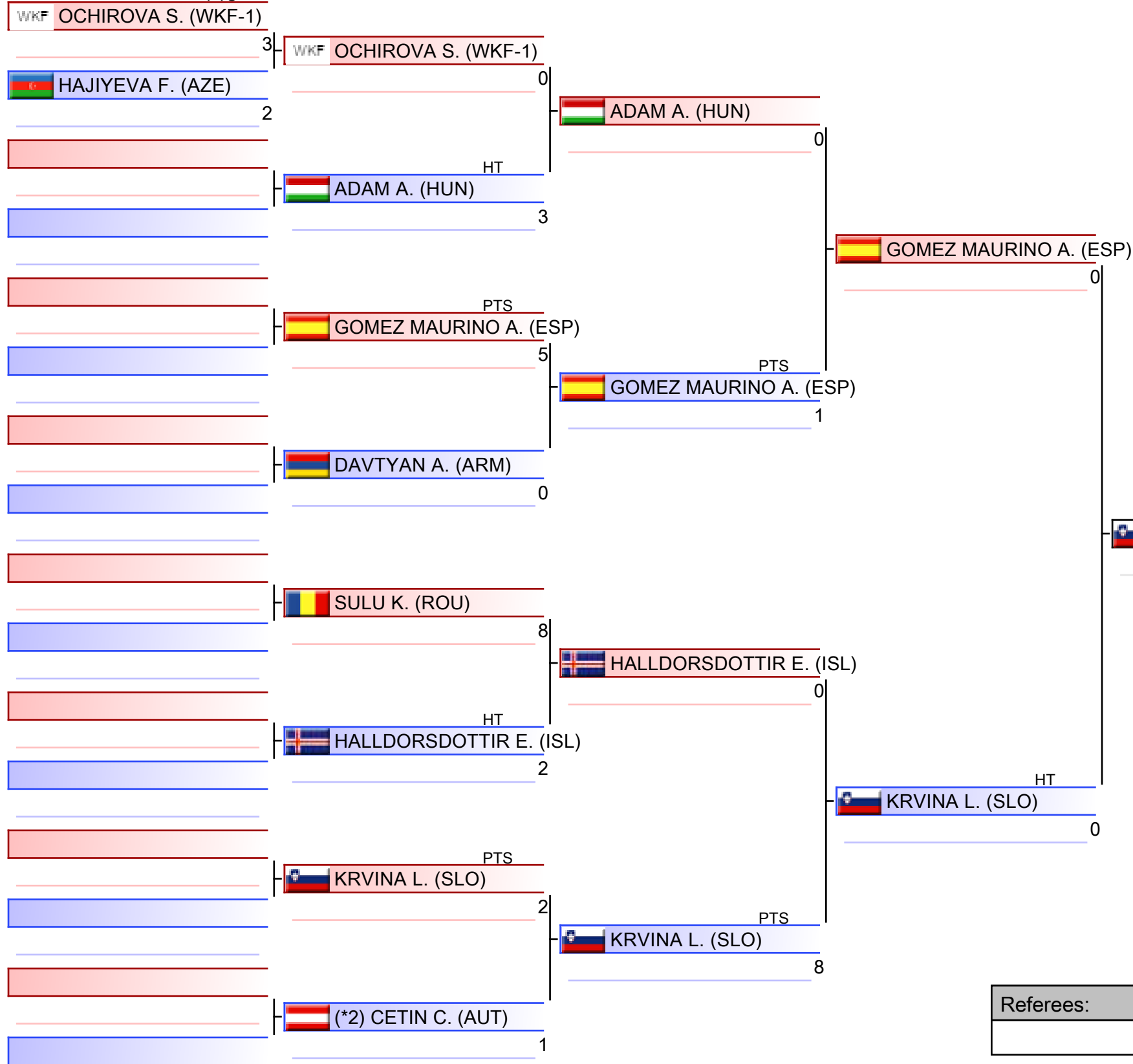

WKF
EUROPE

1. SOENDERGAARD HANNAH BATH (DEN)
2. SCARFONE MORGANE (FRA)
3. LABATSEVICH ALINA (WKF-2)
3. HELLEN ILI (GER)
5. BAZYUK VICTORIA (POR)
5. KRVINA LIA (SLO)
7. BENESOVA NINA (SVK)
7. OLSEN LINA-VIKTORIA SALES (NOR)

*Seeded

Referees:			

Junior Kumite Female -59 kg

EKF Junior, Cadet & U21 Championships 2026 - Limassol, Spyros Kyprianou Athletic Center, Limassol, CYP

2026-02-07

Tatami
6 11:35

Pool
3/4

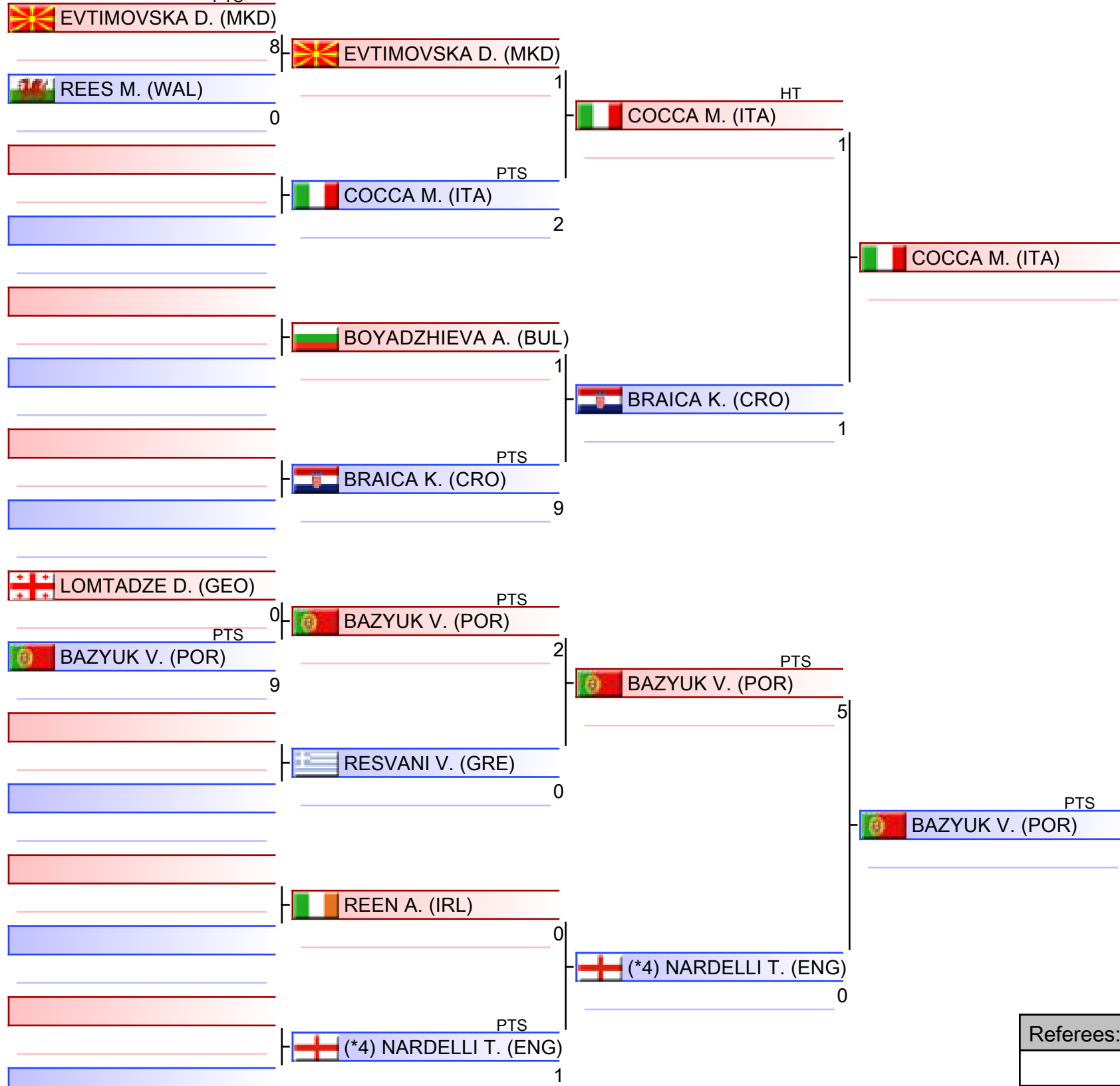

WKF
EUROPE

1. SOENDERGAARD HANNAH BATH (DEN)
2. SCARFONE MORGANE (FRA)
3. LABATSEVICH ALINA (WKF-2)
3. HELLEN ILI (GER)
5. BAZYUK VICTORIA (POR)
5. KRVINA LIA (SLO)
7. BENESOVA NINA (SVK)
7. OLSEN LINA-VIKTORIA SALES (NOR)

*Seeded

Referees:			

Junior Kumite Female -59 kg

EKF Junior, Cadet & U21 Championships 2026 - Limassol, Spyros Kyprianou Athletic Center, Limassol, CYP

2026-02-07

Tatami
6 12:25

Pool
4/4

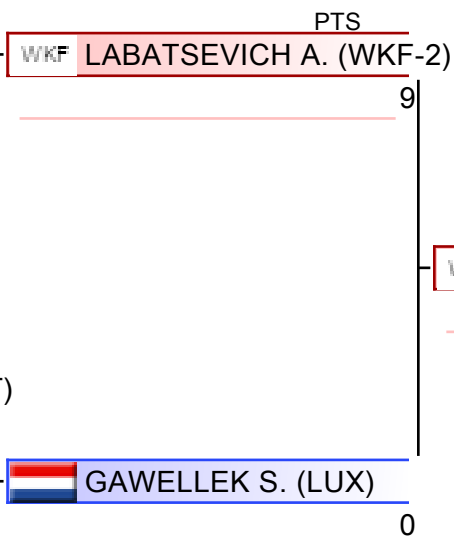
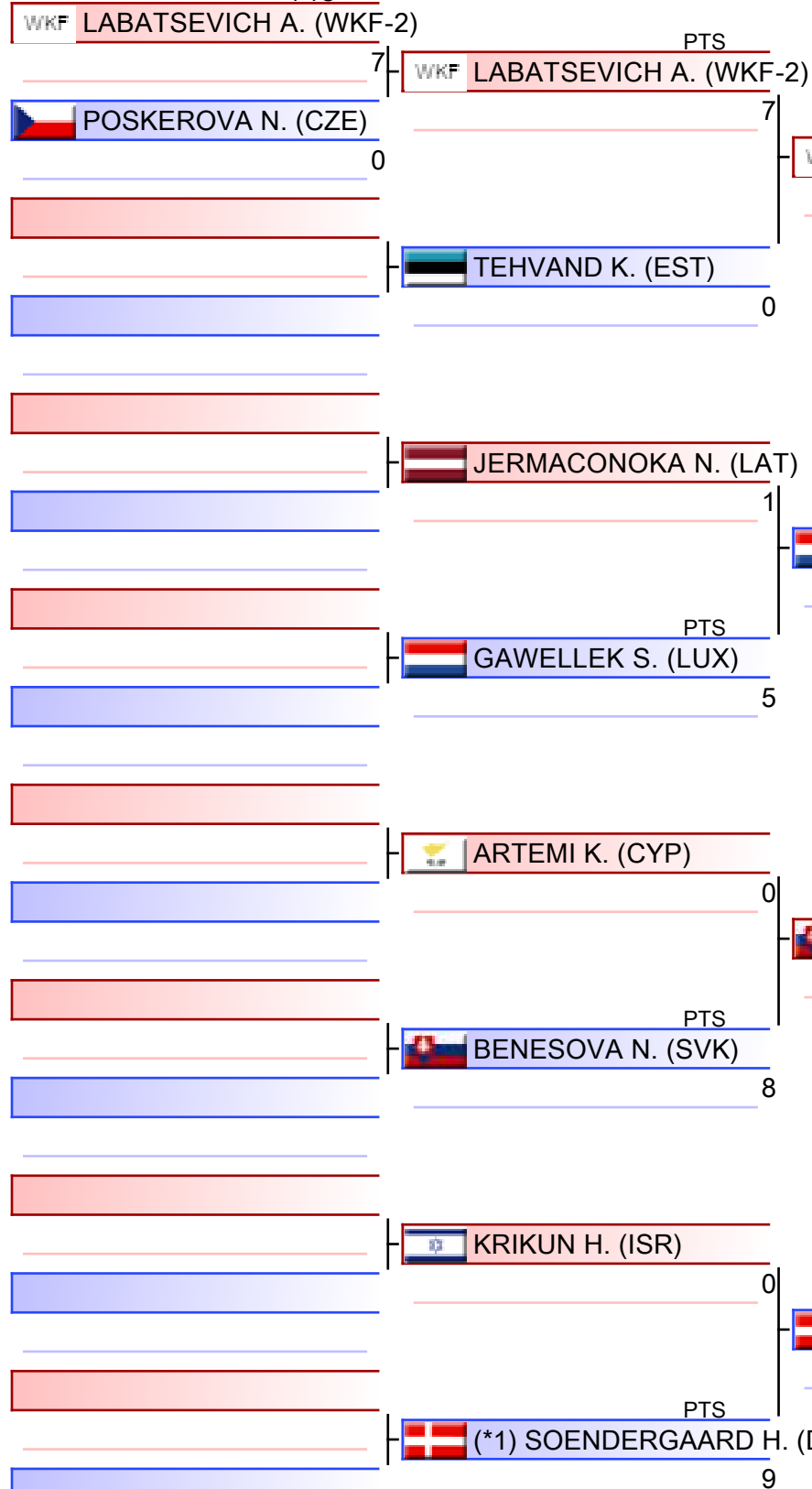

WKF
EUROPE

(*1) SOENDERGAARD H. (DEN)

1. SOENDERGAARD HANNAH BATH (DEN)
2. SCARFONE MORGANE (FRA)
3. LABATSEVICH ALINA (WKF-2)
3. HELLEN ILI (GER)
5. BAZYUK VICTORIA (POR)
5. KRVINA LIA (SLO)
7. BENESOVA NINA (SVK)
7. OLSEN LINA-VIKTORIA SALES (NOR)

*Seeded

Referees:			

Pool winner-Junior Kumite Female -59 kg

EKF Junior, Cadet & U21 Championships 2026 - Limassol, Spyros Kyprianou Athletic Center, Limsassol, CYP

2026-02-07

Tatami
5 13:15

Pool
1/1



WKF
EUROPE

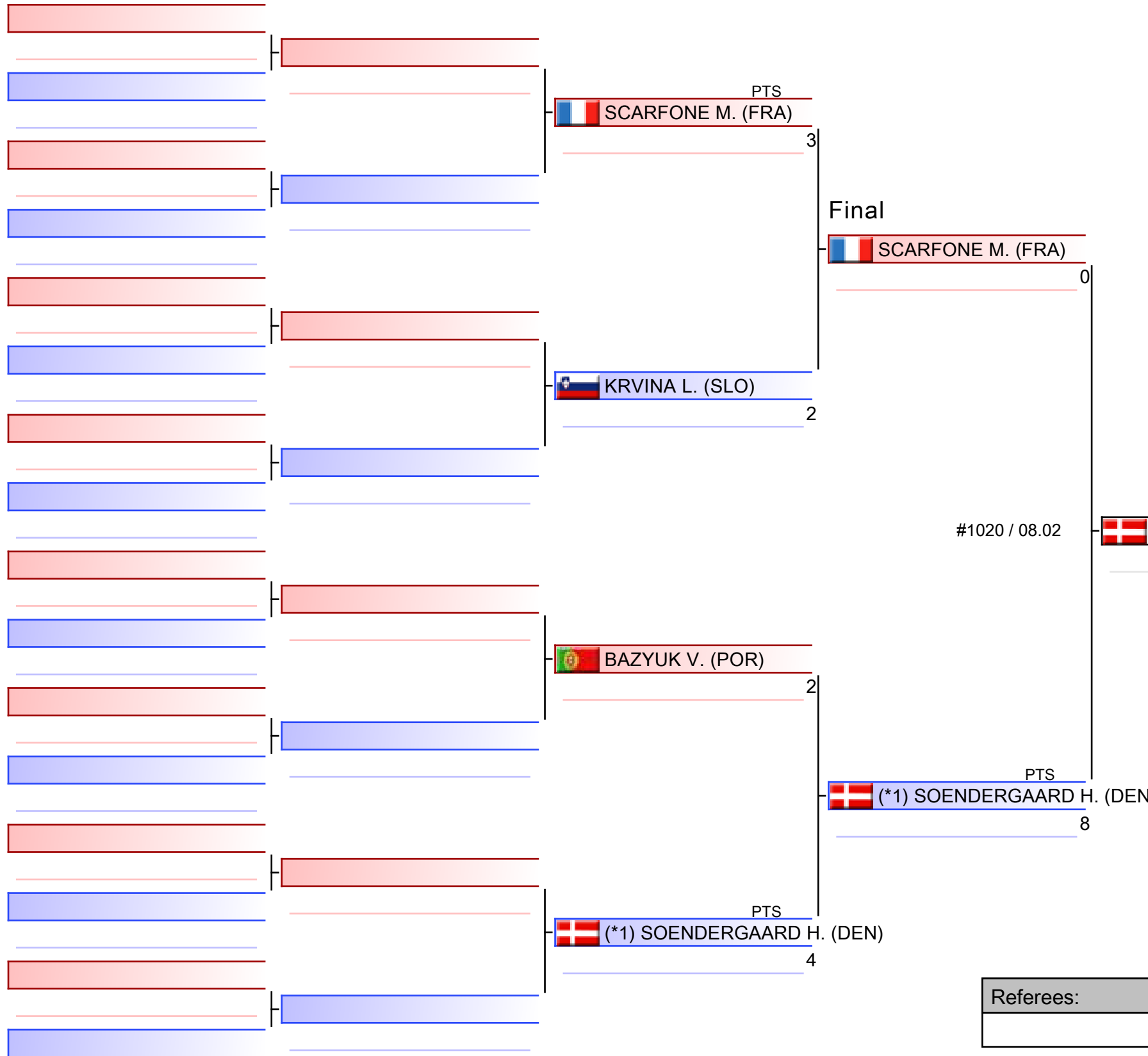

1. SOENDERGAARD HANNAH BATH (DEN)
2. SCARFONE MORGANE (FRA)
3. LABATSEVICH ALINA (WKF-2)
3. HELLEN ILI (GER)
5. BAZYUK VICTORIA (POR)
5. KRVINA LIA (SLO)
7. BENESOVA NINA (SVK)
7. OLSEN LINA-VIKTORIA SALES (NOR)

*Seeded

Referees:			

Junior Kumite Female -59 kg

EKF Junior, Cadet & U21 Championships 2026 - Limassol

2026-02-07

Tatami
8 16:55

Pool
1,2,3,4

(c)sportdata GmbH & Co KG 2000-2026 (2026-02-08 17:46) v 11.0.0 build 2 (2025-01-21 11:49 CET) License: SDIL TWG2025 (expire 2026-09-30)



#109 / 07.02

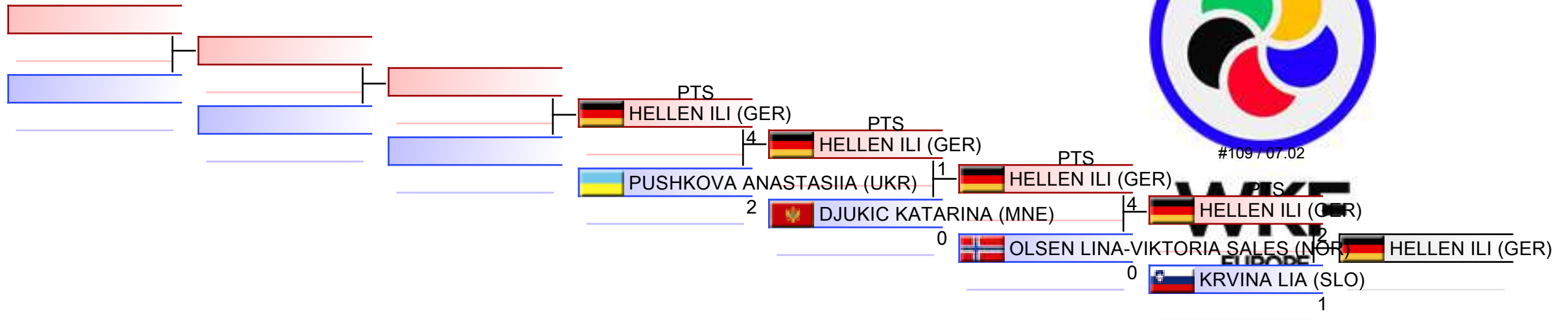

REPECHAGE: (1,2,3,4)

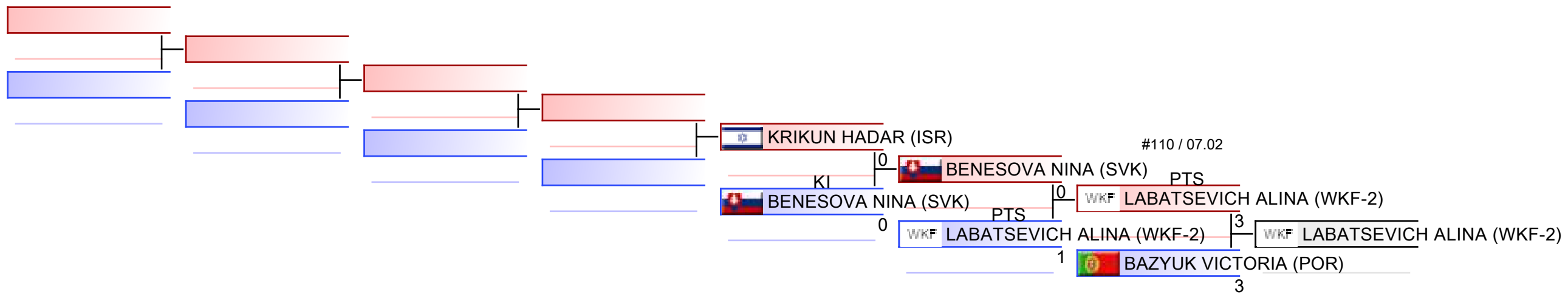

Referees:							
-----------	--	--	--	--	--	--	--



EKF Junior, Cadet & U21 Championships
2026 - Limassol - 2026-02-06



Official Results

Junior Kumite Female -59 kg			
1	SOENDERGAARD HANNAH BATH		DEN - DENMARK
2	SCARFONE MORGANE		FRA - FRANCE
3	LABATSEVICH ALINA	WKF	WKF-2 - WKF-2
3	HELLEN ILI		GER - GERMANY
5	BAZYUK VICTORIA		POR - PORTUGAL
5	KRVINA LIA		SLO - SLOVENIA
7	BENESOVA NINA		SVK - SLOVAKIA
7	OLSEN LINA-VIKTORIA SALES		NOR - NORWAY
9	KRIKUN HADAR		ISR - ISRAEL
9	DJUKIC KATARINA		MNE - MONTENEGRO
11	PUSHKOVA ANASTASIIA		UKR - UKRAINE

JUNIOR KUMITE FEMALE -66 KG



EKF Junior, Cadet & U21 Championships 2026 - Lim..



ENTRIES BY WEIGHT CATEGORY

Junior Kumite Female -66 kg

As of 8 FEB 2026

Code	ID	Gender	Name	Seeding
AUT	AUT03005	F	KEMETINGER SARAH	
AZE	AZE03304	F	AHMADZADA JANSU	
BIH	BIH2637	F	ASCIC SEJLA	
BUL	BUL02967	F	ABULIBDE AMIRA	
CRO	CRO2818	F	STRAHIJA LAURA	
CYP	CYP03094	F	KYRIAKOU STAVRI	
CZE	CZE02436	F	BUKOVSKA LUCIE	
DEN	DEN002995	F	BONDERUP ALBERTE	
ENG	ENG003394	F	CUTLER SOFIA	
ESP	ESP003967	F	LOPEZ GONZALEZ NOA	
FRA	FRA04089	F	PICAZO LUQUE ELEONOR	
GEO	GEO02865	F	KULUKHASHVILI MAKI	
GER	GER03639	F	KOENIG LIV SVENDE	
GRE	GRE03631	F	DOUKA VIOLETTA-FANOURIA	
HUN	HUN003521	F	ADAM VIVIEN	
IRL	IRL003102	F	SHERIDAN SOPHIE	
ITA	ITA05404	F	CATTANEO ELISA	1
LAT	LAT02719	F	SPRADZINA ARIANNA	
LTU	LTU002587	F	VOLODZKAITE GERDA	
LUX	LUX02432	F	DE RUBEIS GIULIA	
MKD	MKD03315	F	SHTERIEVA MILA	
MLT	MLT02160	F	ANTONELLI THYIS	
MNE	MNE02886	F	SAKOTIC LARA	
NOR	NOR002904	F	VUKAJLOVIC EMA	
POL	POL12674	F	WALCZAK KLAUDIA	
POR	POR03184	F	CADETE BEATRIZ	
ROU	ROU003950	F	LUDOVICA CARACAS	
SCO	SCO02523	F	BAULD ELIZE	3
SLO	SLO02705	F	MEDIC ADELA	
SRB	SRB03471	F	MANOJLOVIC ANA	
SUI	SUI003192	F	ARIFAGIC ALMINA	
SVK	SVK02805	F	ZEUMEROVA ALEXANDRA	2
UKR	UKR03150	F	BARANOVA ULIANA	4
WKF-1	AIN-1006460	F	MILOVANOVA VALERIIA	
WKF-2	WKF-2002980	F	POLUKHLEB KSENIYA	

Junior Kumite Female -66 kg

EKF Junior, Cadet & U21 Championships 2026 - Limassol, Spyros Kyprianou Athletic Center, Limassol, CYP

2026-02-07

Tatami
7 11:55

Pool
1/4

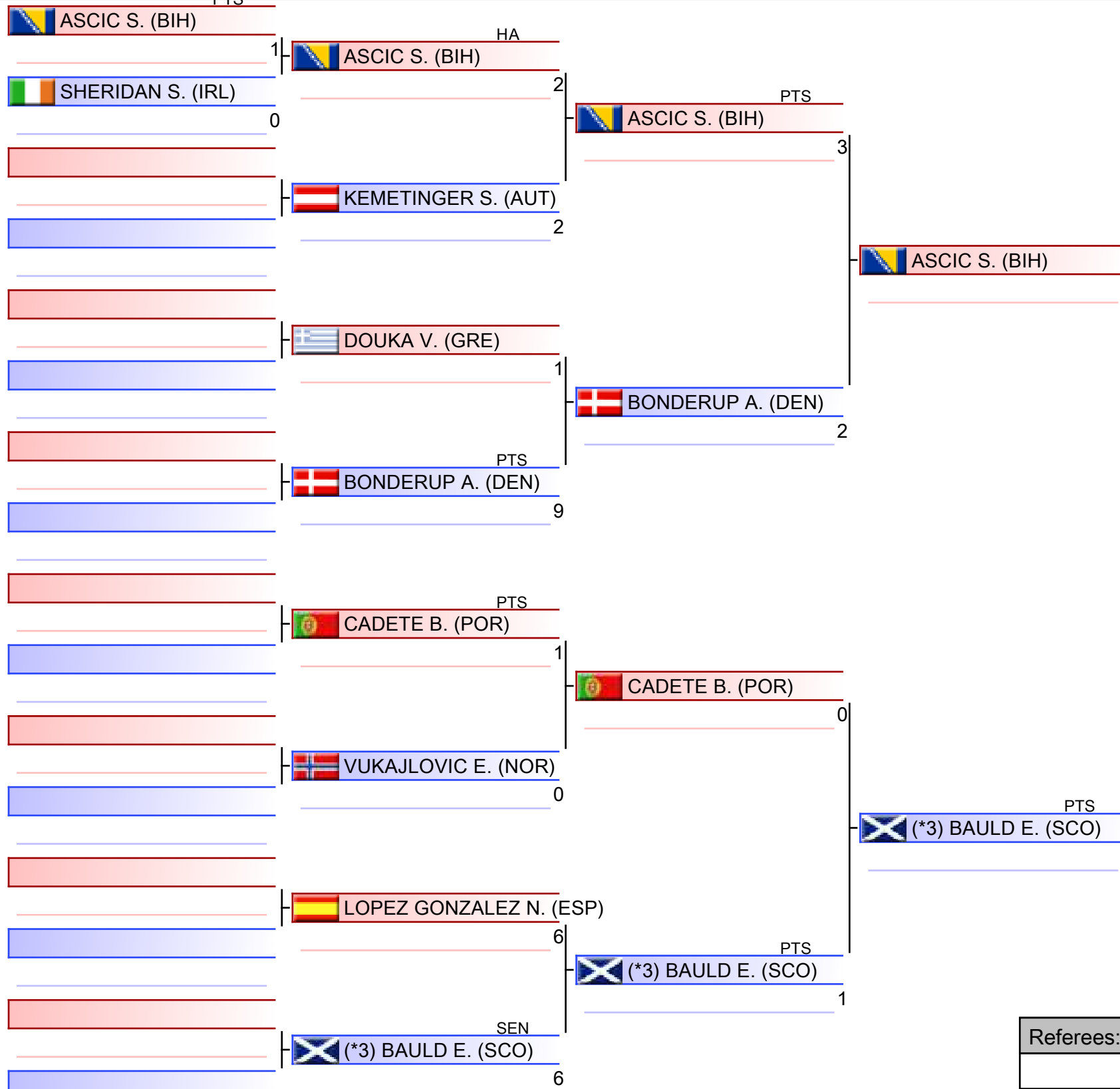

WKF
EUROPE

(*3) BAULD E. (SCO)

1. BAULD ELIZE (SCO)
2. BARANOVA ULIANA (UKR)
3. AHMADZADA JANSU (AZE)
3. LOPEZ GONZALEZ NOA (ESP)
5. MILOVANOVA VALERIIA (WKF-1)
5. ARIFAGIC ALMINA (SUI)
7. BUKOVSKA LUCIE (CZE)
7. ASCIC SEJLA (BIH)

*Seeded

Referees:			

Junior Kumite Female -66 kg

EKF Junior, Cadet & U21 Championships 2026 - Limassol, Spyros Kyprianou Athletic Center, Limassol, CYP

2026-02-07

Tatami
7 12:40

Pool
2/4

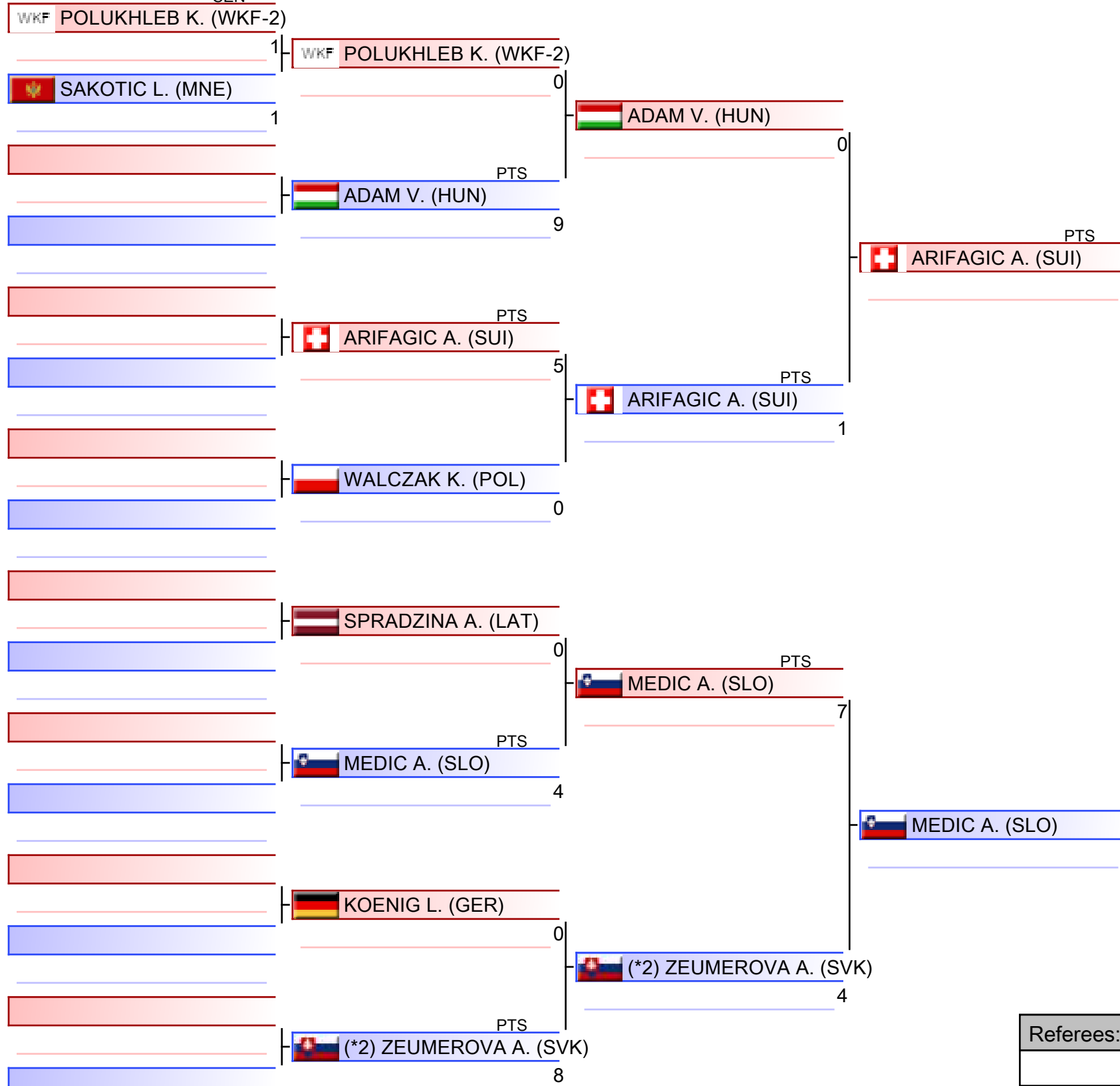

WKF
EUROPE

1. BAULD ELIZE (SCO)
2. BARANOVA ULIANA (UKR)
3. AHMADZADA JANSU (AZE)
3. LOPEZ GONZALEZ NOA (ESP)
5. MILOVANOVA VALERIIA (WKF-1)
5. ARIFAGIC ALMINA (SUI)
7. BUKOVSKA LUCIE (CZE)
7. ASCIC SEJLA (BIH)

*Seeded

Referees:			

Junior Kumite Female -66 kg

EKF Junior, Cadet & U21 Championships 2026 - Limassol, Spyros Kyprianou Athletic Center, Limassol, CYP

2026-02-07

Tatami
8 11:50

Pool
3/4

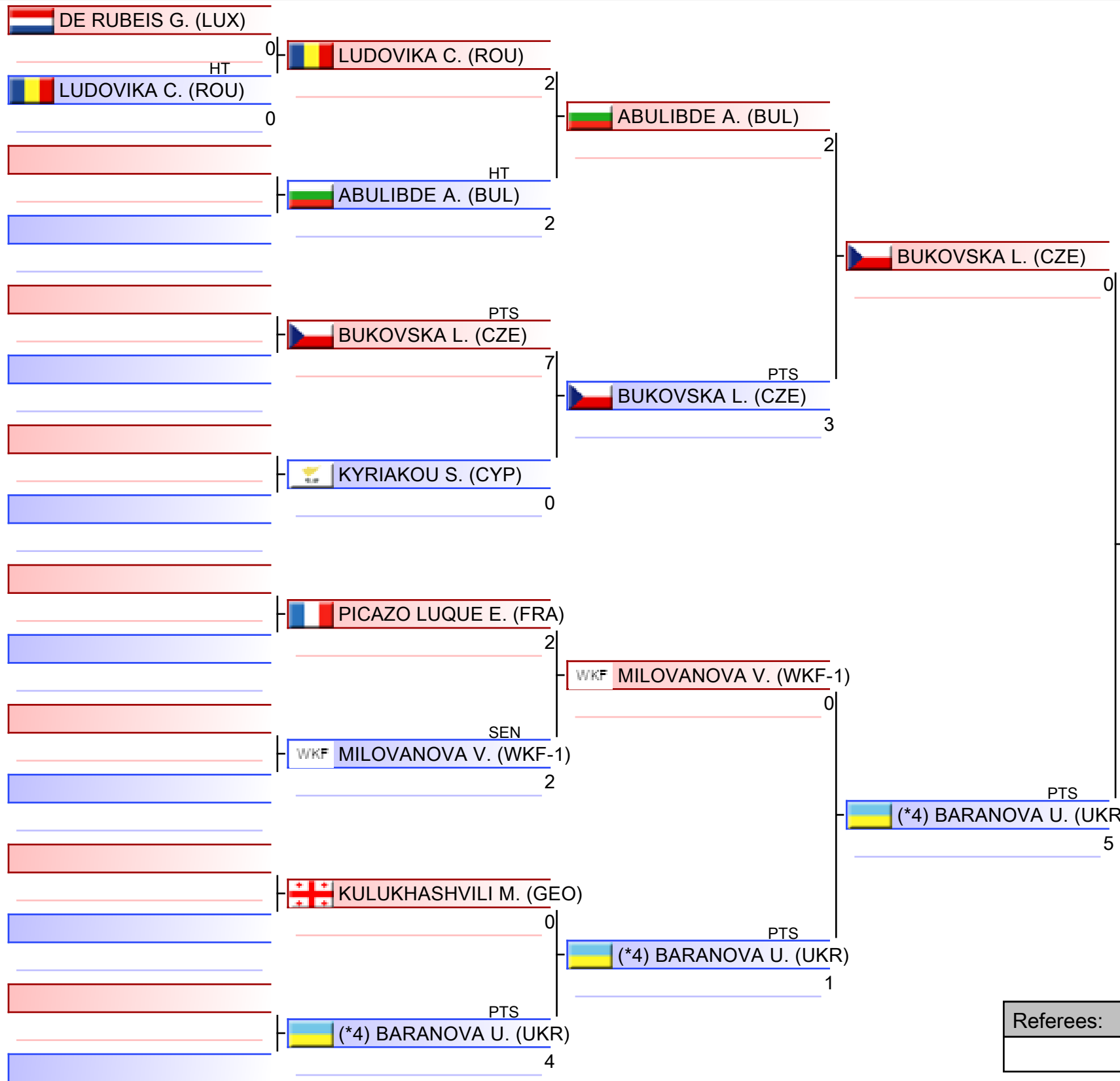

WKF
EUROPE

(*4) BARANOVA U. (UKR)

1. BAULD ELIZE (SCO)
2. BARANOVA ULIANA (UKR)
3. AHMADZADA JANSU (AZE)
3. LOPEZ GONZALEZ NOA (ESP)
5. MILOVANOVA VALERIIA (WKF-1)
5. ARIFAGIC ALMINA (SUI)
7. BUKOVSKA LUCIE (CZE)
7. ASCIC SEJLA (BIH)

*Seeded

Referees:			

Junior Kumite Female -66 kg

EKF Junior, Cadet & U21 Championships 2026 - Limassol, Spyros Kyprianou Athletic Center, Limassol, CYP

2026-02-07

Tatami
8 12:35

Pool
4/4



WKF
EUROPE

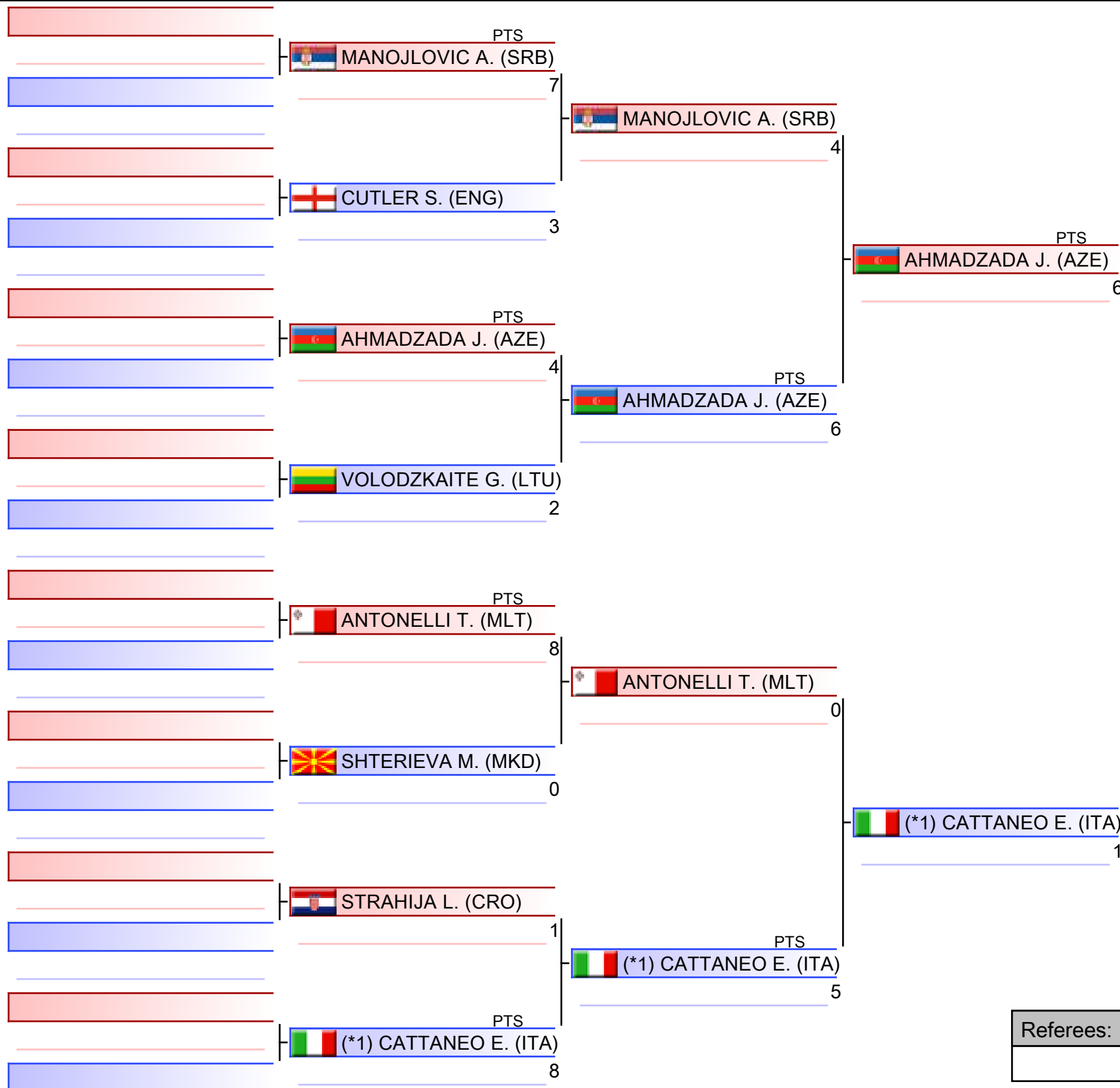

AHMADZADA J. (AZE)

1. BAULD ELIZE (SCO)
2. BARANOVA ULIANA (UKR)
3. AHMADZADA JANSU (AZE)
3. LOPEZ GONZALEZ NOA (ESP)
5. MILOVANOVA VALERIIA (WKF-1)
5. ARIFAGIC ALMINA (SUI)
7. BUKOVSKA LUCIE (CZE)
7. ASCIC SEJLA (BIH)

*Seeded

Referees:			

Pool winner-Junior Kumite Female -66 kg

EKF Junior, Cadet & U21 Championships 2026 - Limassol, Spyros Kyprianou Athletic Center, Limsassol, CYP

2026-02-07

Tatami
7 13:25

Pool
1/1



WKF
EUROPE

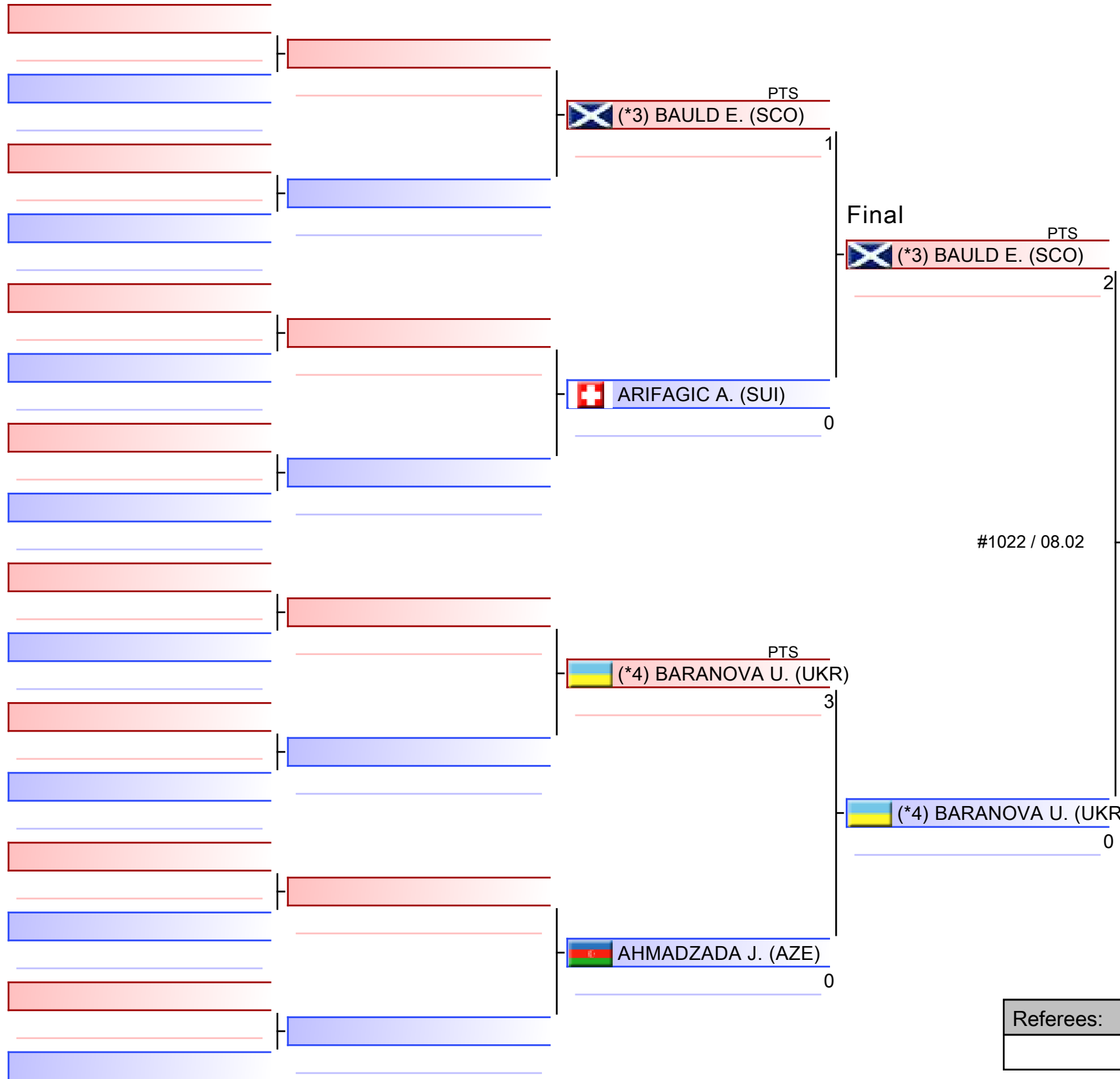

1. BAULD ELIZE (SCO)
2. BARANOVA ULIANA (UKR)
3. AHMADZADA JANSU (AZE)
3. LOPEZ GONZALEZ NOA (ESP)
5. MILOVANOVA VALERIIA (WKF-1)
5. ARIFAGIC ALMINA (SUI)
7. BUKOVSKA LUCIE (CZE)
7. ASCIC SEJLA (BIH)

*Seeded

Referees:			

Junior Kumite Female -66 kg

EKF Junior, Cadet & U21 Championships 2026 - Limassol

2026-02-07

Tatami

7 17:20

Pool

1,2,3,4

(c)sportdata GmbH & Co KG 2000-2026 (2026-02-08 17:46) v 11.0.0 build 2 (2025-01-21 11:49 CET) License: SDIL TWG2025 (expire 2026-09-30)

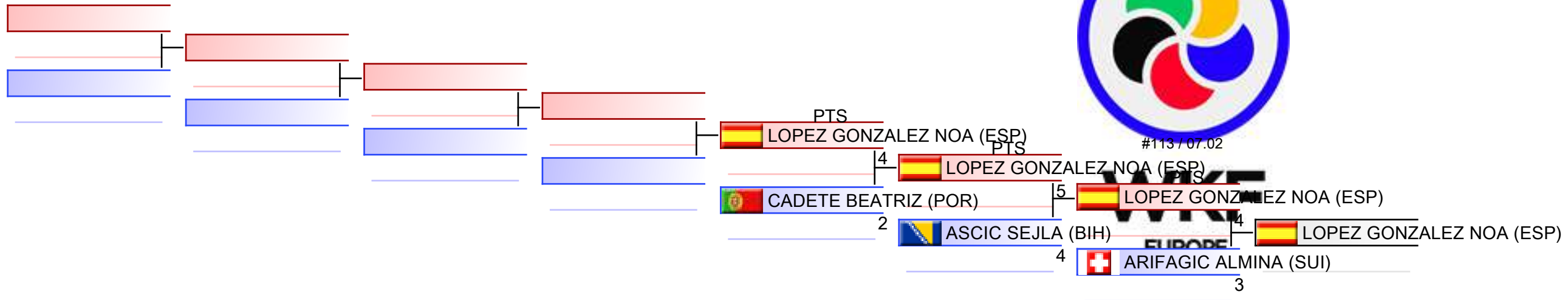

REPECHAGE: (1,2,3,4)

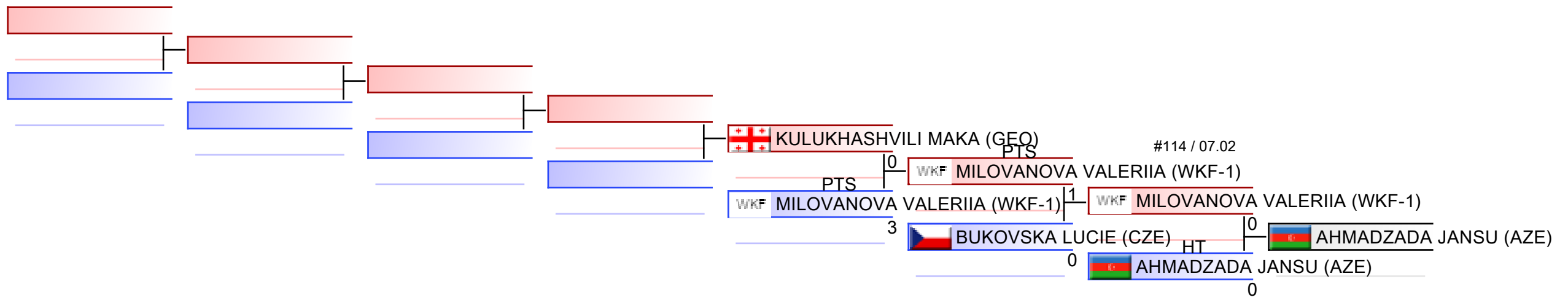

Referees:							
-----------	--	--	--	--	--	--	--



EKF Junior, Cadet & U21 Championships
2026 - Limassol - 2026-02-06



Official Results

Junior Kumite Female -66 kg			
1	BAULD ELIZE		SCO - SCOTLAND
2	BARANOVA ULIANA		UKR - UKRAINE
3	AHMADZADA JANSU		AZE - AZERBAIJAN
3	LOPEZ GONZALEZ NOA		ESP - SPAIN
5	MILOVANOVA VALERIIA		WKF-1 - WKF-1
5	ARIFAGIC ALMINA		SUI - SWITZERLAND
7	BUKOVSKA LUCIE		CZE - CZECH REPUBLIC
7	ASCIC SEJLA		BIH - BOSNIA AND HERZEGOVINA
9	KULUKHASHVILI MAKI		GEO - GEORGIA
9	CADETE BEATRIZ		POR - PORTUGAL

JUNIOR KUMITE FEMALE 66+ KG



EKF Junior, Cadet & U21 Championships 2026 - Lim..

ENTRIES BY WEIGHT CATEGORY



Junior Kumite Female 66+ kg

As of 8 FEB 2026

Code	ID	Gender	Name	Seeding
BEL	BEL03145	F	SRIDI MAISSA	2
BIH	BIH03291	F	KURTANOVIC AJLIN	
BUL	BUL003387	F	DIMITROVA DARIA	
CRO	CRO03725	F	DUDUKOVIC NINA	
CYP	CYP02746	F	MICHAELIDOU ANNA	
CZE	CZE02479	F	KLEWAROVA MARKETA	
DEN	DEN002957	F	HVITVED-ARNESEN AMALIE	
ENG	ENG02902	F	TEWLEY RENEE	
ESP	ESP03591	F	RAMIREZ GRANDE ERIKA	
EST	EST02566	F	LANBERG ALJONA	
FRA	FRA004505	F	ONANA CHARLENE	
GEO	GEO003073	F	OTINASHVILI ELENE	
GER	GER03808	F	DAWOUD DALIA	4
GRE	GRE03013	F	DOUKA EFFROSYNI DAVIDOULA	
HUN	HUN003517	F	SZEBEGYINSZKI RITA	
ITA	ITA05405	F	CORREDDU NICOLE	1
MNE	MNE2447	F	RAKOVIC UNA	
NED	NED02733	F	VALK IMANE	
POL	POL3964	F	BALUT NATALIA	
ROU	ROU03337	F	ANGHEL BIANCA	
SCO	SCO02409	F	EWING MAIA	3
SLO	SLO03048	F	KRISTANCIC ZIVA	
SRB	SRB004837	F	MILOJEVIC STASA	
SUI	SUI03113	F	REDZIC ESMA	
SVK	SVK003404	F	KULIKOVA VIRA	
UKR	UKR003926	F	TROFYMENKO SOFIIA	
WKF-1	AIN-1006471	F	KRAPIVINA KIRA	

Junior Kumite Female 66+ kg

EKF Junior, Cadet & U21 Championships 2026 - Limassol, Spyros Kyprianou Athletic Center, Limassol, CYP

2026-02-07

Tatami
1 13:15

Pool
1/4



WKF
EUROPE

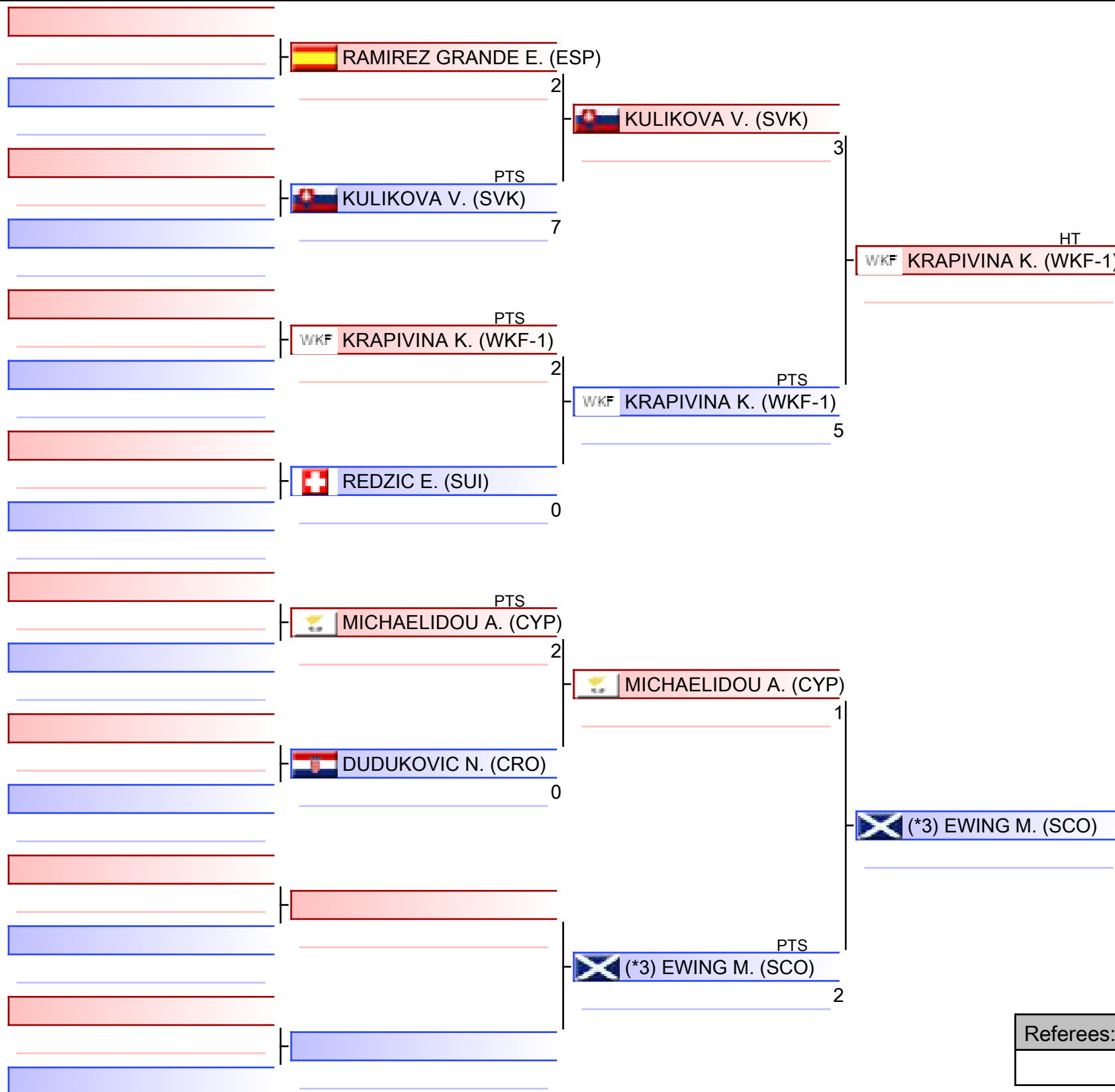

WKF KRAPIVINA K. (WKF-1)

1. RAKOVIC UNA (MNE)
2. CORREDDU NICOLE (ITA)
3. BALUT NATALIA (POL)
3. KURTANOVIC AJLIN (BIH)
5. DAWOUD DALIA (GER)
5. KRAPIVINA KIRA (WKF-1)
7. LANBERG ALJONA (EST)
7. KLEWAROVA MARKETKA (CZE)

*Seeded

Referees:			

Junior Kumite Female 66+ kg

EKF Junior, Cadet & U21 Championships 2026 - Limassol, Spyros Kyprianou Athletic Center, Limassol, CYP

2026-02-07

Tatami
1 13:50

Pool
2/4



WKF
EUROPE

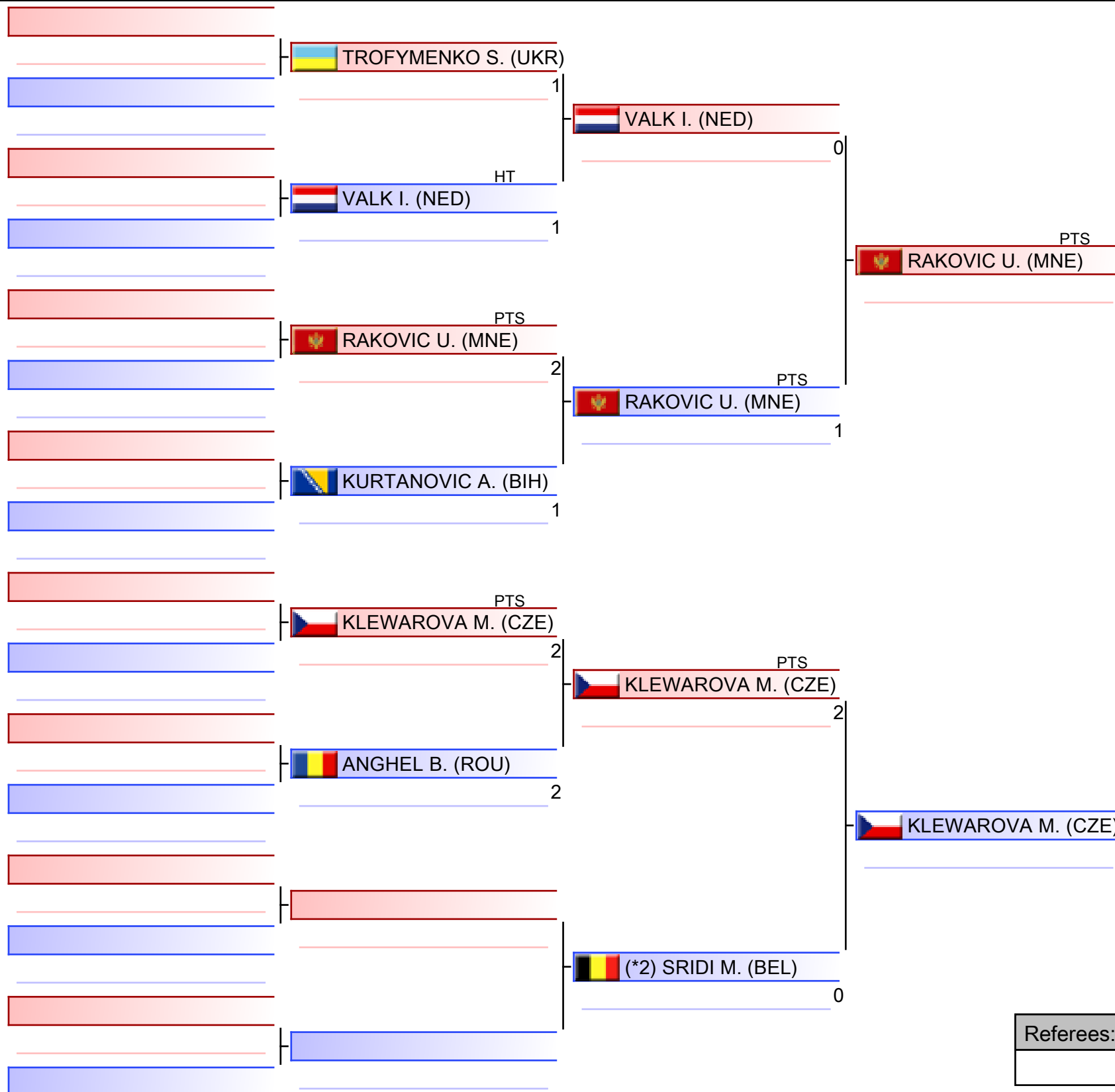

RAKOVIC U. (MNE)

1. RAKOVIC UNA (MNE)
2. CORREDDU NICOLE (ITA)
3. BALUT NATALIA (POL)
3. KURTANOVIC AJLIN (BIH)
5. DAWOUD DALIA (GER)
5. KRAPIVINA KIRA (WKF-1)
7. LANBERG ALJONA (EST)
7. KLEWAROVA MARKETETA (CZE)

*Seeded

Referees:			

Junior Kumite Female 66+ kg

EKF Junior, Cadet & U21 Championships 2026 - Limassol, Spyros Kyprianou Athletic Center, Limassol, CYP

2026-02-07

Tatami
2 13:10

Pool
3/4



WKF
EUROPE

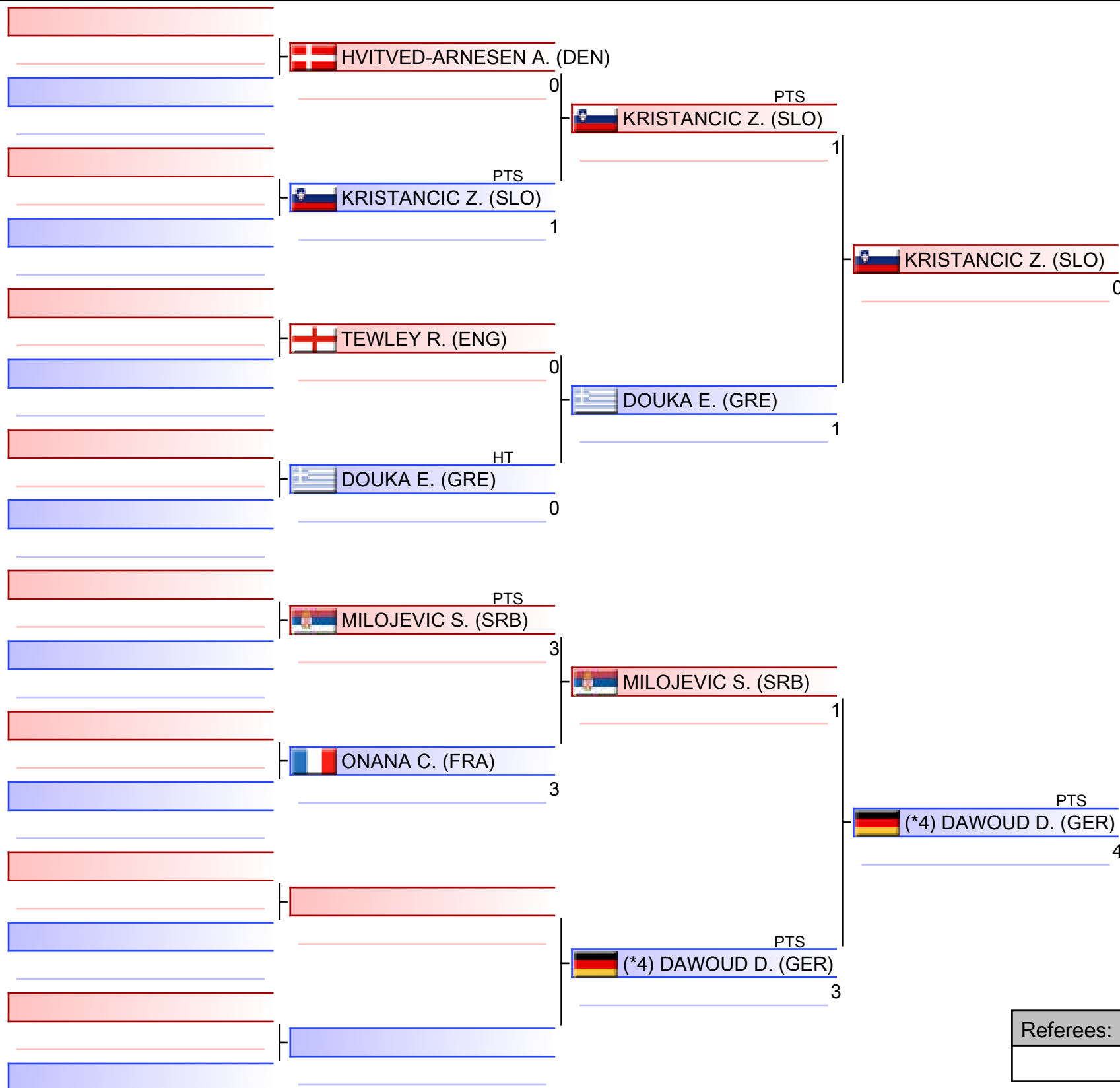

(*4) DAWOUD D. (GER)

1. RAKOVIC UNA (MNE)
2. CORREDDU NICOLE (ITA)
3. BALUT NATALIA (POL)
3. KURTANOVIC AJLIN (BIH)
5. DAWOUD DALIA (GER)
5. KRAPIVINA KIRA (WKF-1)
7. LANBERG ALJONA (EST)
7. KLEWAROVA MARKETKA (CZE)

*Seeded

Referees:			

Junior Kumite Female 66+ kg

EKF Junior, Cadet & U21 Championships 2026 - Limassol, Spyros Kyprianou Athletic Center, Limsassol, CYP

2026-02-07

Tatami
2 13:45

Pool
4/4



WKF
EUROPE

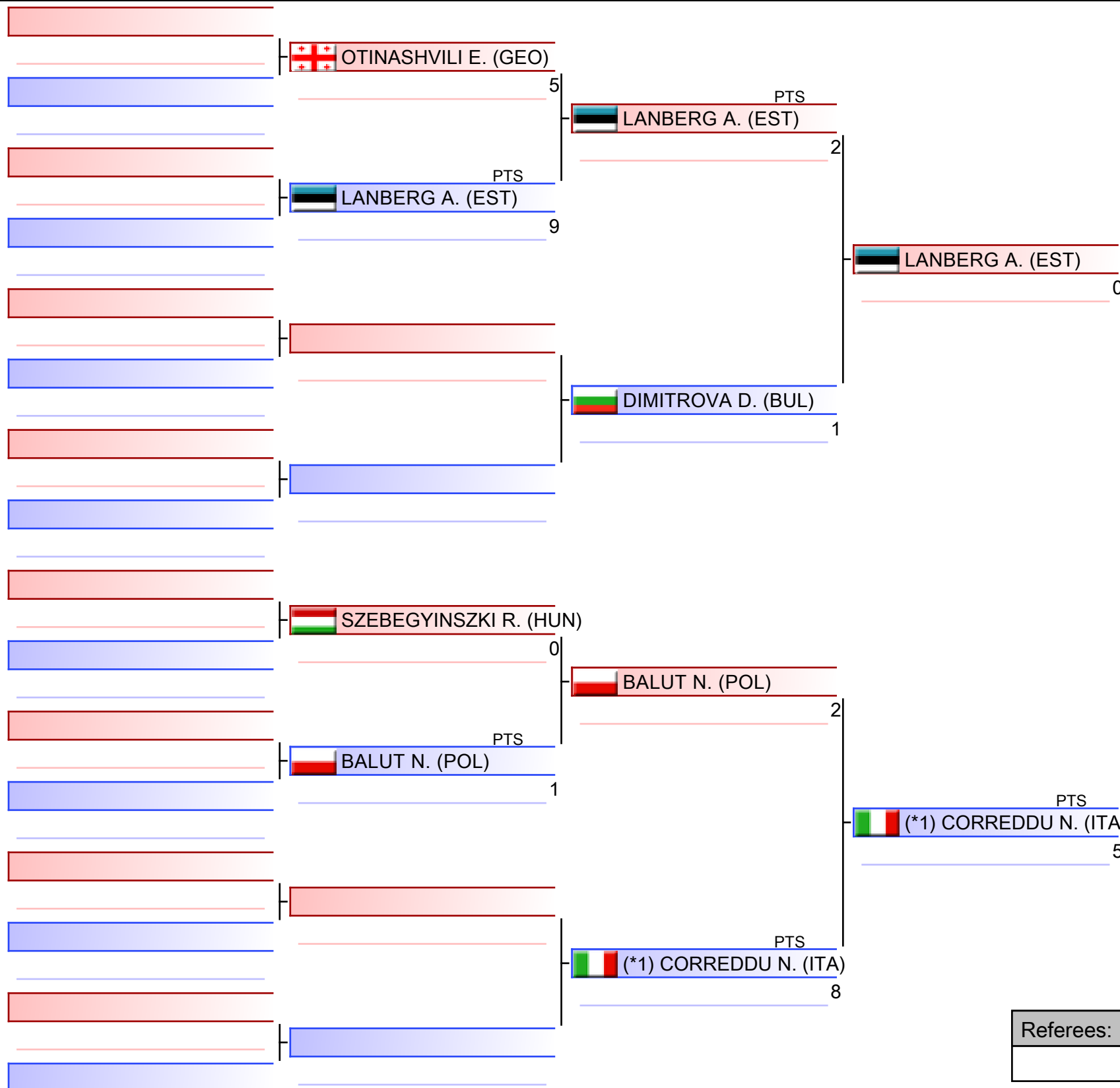

(*1) CORREDDU N. (ITA)

1. RAKOVIC UNA (MNE)
2. CORREDDU NICOLE (ITA)
3. BALUT NATALIA (POL)
3. KURTANOVIC AJLIN (BIH)
5. DAWOUD DALIA (GER)
5. KRAPIVINA KIRA (WKF-1)
7. LANBERG ALJONA (EST)
7. KLEWAROVA MARKETKA (CZE)

*Seeded

Referees:			

Pool winner-Junior Kumite Female 66+ kg

EKF Junior, Cadet & U21 Championships 2026 - Limassol, Spyros Kyprianou Athletic Center, Limsassol, CYP

2026-02-07

Tatami
1 14:25

Pool
1/1

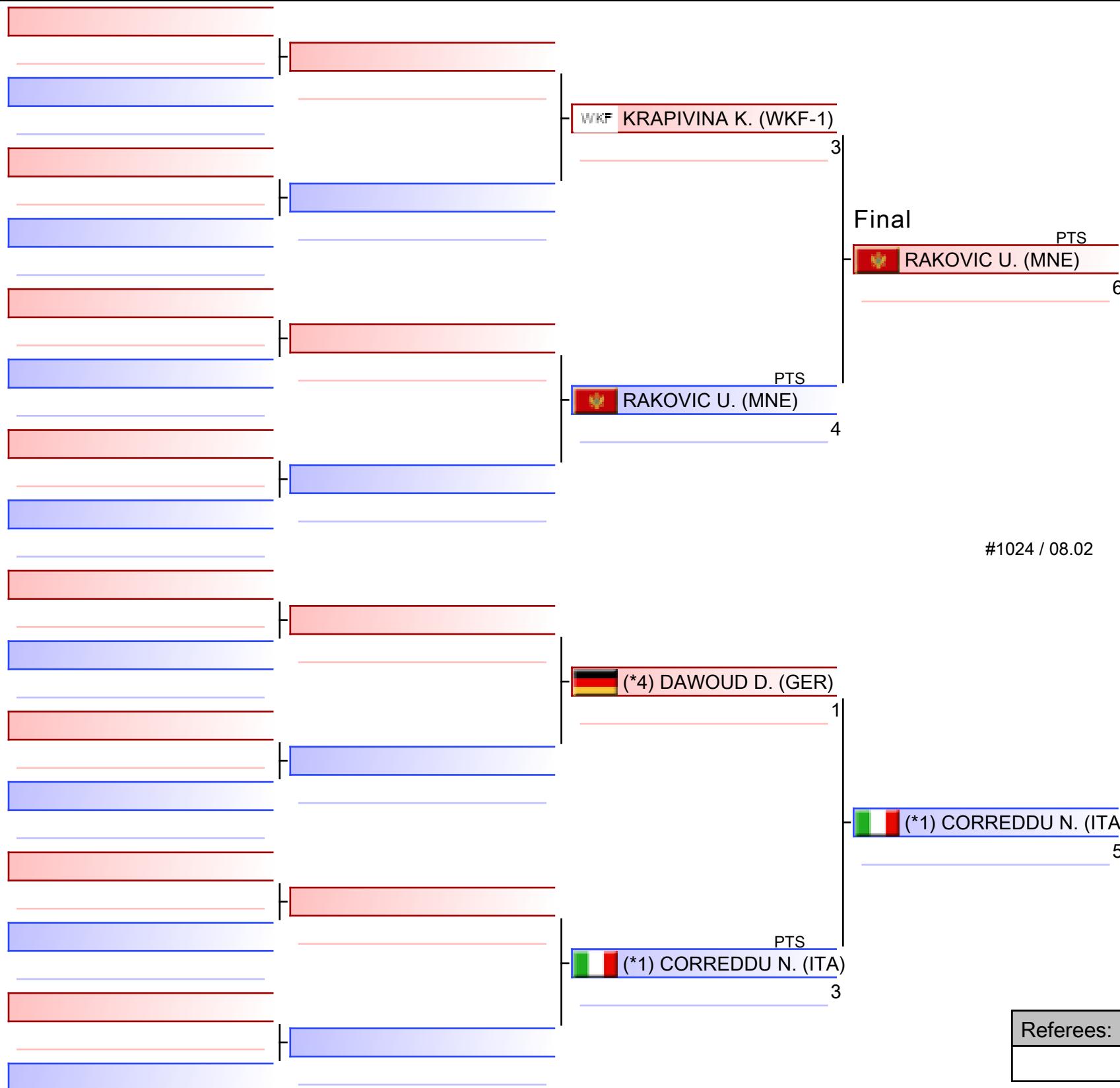

WKF
EUROPE

1. RAKOVIC UNA (MNE)
2. CORREDDU NICOLE (ITA)
3. BALUT NATALIA (POL)
3. KURTANOVIC AJLIN (BIH)
5. DAWOUD DALIA (GER)
5. KRAPIVINA KIRA (WKF-1)
7. LANBERG ALJONA (EST)
7. KLEWAROVA MARKETKA (CZE)

*Seeded

Referees:			

Junior Kumite Female 66+ kg

EKF Junior, Cadet & U21 Championships 2026 - Limassol

2026-02-07

Tatami

4 17:35

Pool

1,2,3,4

(c)sportdata GmbH & Co KG 2000-2026 (2026-02-08 17:46) v 11.0.0 build 2 (2025-01-21 11:49 CET) License: SDIL TWG2025 (expire 2026-09-30)

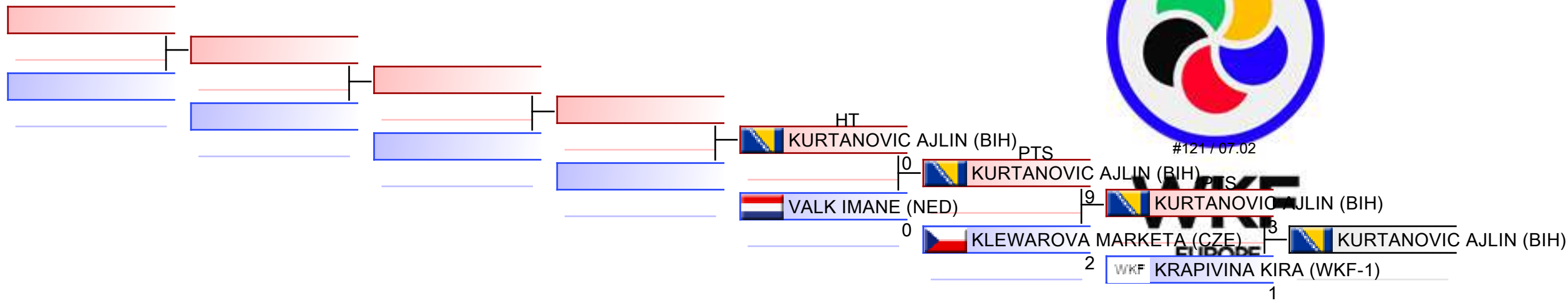

REPECHAGE: (1,2,3,4)

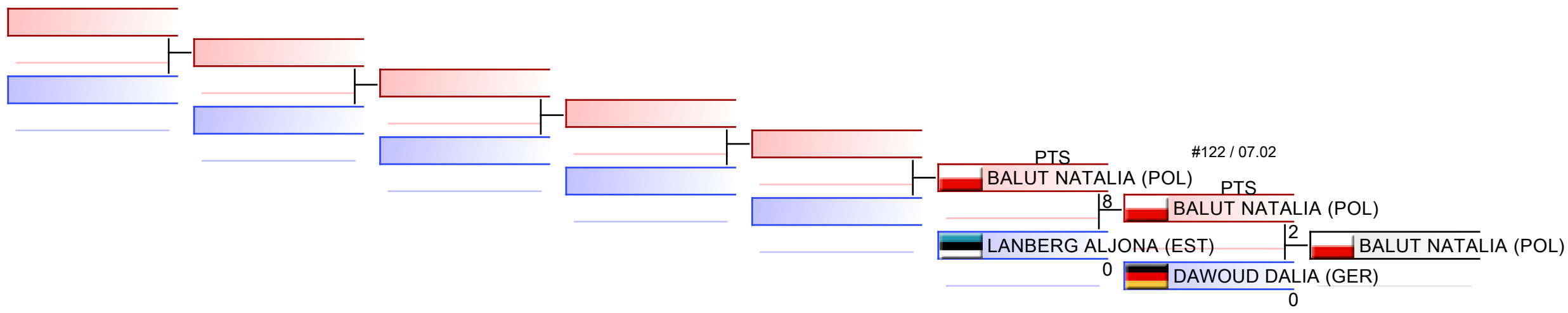

Referees:							
-----------	--	--	--	--	--	--	--



EKF Junior, Cadet & U21 Championships
2026 - Limassol - 2026-02-06



Official Results

Junior Kumite Female 66+ kg			
1	RAKOVIC UNA		MNE - MONTENEGRO
2	CORREDDU NICOLE		ITA - ITALY
3	BALUT NATALIA		POL - POLAND
3	KURTANOVIC AJLIN		BIH - BOSNIA AND HERZEGOVINA
5	DAWOUD DALIA		GER - GERMANY
5	KRAPIVINA KIRA		WKF-1 - WKF-1
7	LANBERG ALJONA		EST - ESTONIA
7	KLEWAROVA MARKETKA		CZE - CZECH REPUBLIC
9	VALK IMANE		NED - NETHERLANDS

JUNIOR KUMITE MALE -55 KG



EKF Junior, Cadet & U21 Championships 2026 - Lim..



ENTRIES BY WEIGHT CATEGORY

Junior Kumite Male -55 kg

As of 8 FEB 2026

Code	ID	Gender	Name	Seeding
ARM	ARM02373	M	GRIGORYAN ALEN	
AZE	AZE02344	M	GANBAROV VUSAL	2
BEL	BEL03142	M	ABDELMALKI YOUSSEF	3
CRO	CRO03461	M	PAPONJA DAVID	
CYP	CYP02813	M	ANDREOU CHRISTAKIS	
CZE	CZE02427	M	HARVILKO SIMON	
DEN	DEN002998	M	KRISTENSEN ELIAS MAITSLAND	
ESP	ESP03607	M	GOMEZ MAURINO DAVID	
EST	EST02600	M	TIMAK TAAGO	
FRA	FRA004506	M	HAMMADA ANASS	
GEO	GEO02860	M	ALANIA GIGI	
GER	GER004279	M	LIUBYMOV DMYTRO	
GRE	GRE02758	M	PAPADOPOULOS DIMOSTHENIS	
HUN	HUN003324	M	LOSONCI LORANT MARCELL	
ISL	ISL002492	M	BUENVIAJE CAAMIC PRINCE JAMES	
ISR	ISR02934	M	ABRAMCHAYEV NETANEL	
ITA	ITA005910	M	MONDO BRANCHI MATTEO	
LAT	LAT02515	M	BALZARIS MIROSLAVS	
LUX	LUX02667	M	SZEKERES MAXIM	
MKD	MKD02654	M	MITREVSKI DAMJAN	
MNE	MNE2428	M	LAZOVIC BRANKO	4
POL	POL3560	M	ZYGANOWSKI JAKUB	
POR	POR003487	M	REBELO JOAO	
ROU	ROU03585	M	DAVID GABRIEL MUTU	
SCO	SCO002913	M	REYNOLDS SONNY	
SUI	SUI003763	M	ALVES DA GLORIA PATRICK	
SVK	SVK003405	M	ZABKA OLIVER	
SWE	SWE003236	M	MUSTAFA JOSEF	
UKR	UKR03559	M	VIECHKANOV MAKSYM	1
WKF-1	AIN-1006350	M	TEKUEV ALYI	
WKF-2	AIN-2002849	M	KAPANITSA YAGOR	

Junior Kumite Male -55 kg

EKF Junior, Cadet & U21 Championships 2026 - Limassol, Spyros Kyprianou Athletic Center, Limassol, CYP

2026-02-07

Tatami
5 10:15

Pool
1/4



WKF
EUROPE

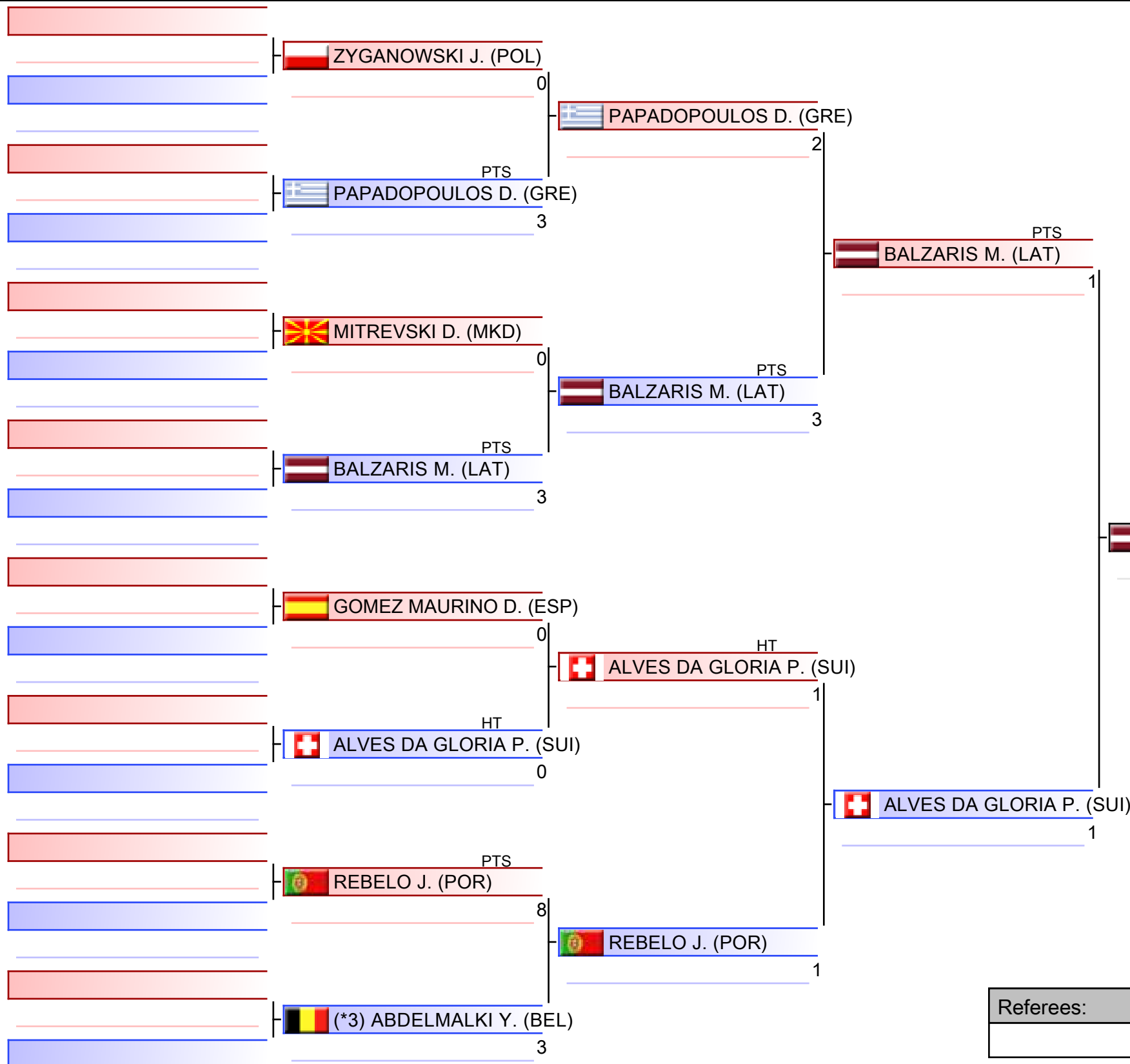

1. VIECHKANOV MAKSYM (UKR)
2. GANBAROV VUSAL (AZE)
3. TEKUEV ALYI (WKF-1)
3. MONDO BRANCHI MATTEO (ITA)
5. BALZARIS MIROSLAVS (LAT)
5. DAVID GABRIEL MUTU (ROU)
7. MUSTAFA JOSEF (SWE)
7. KRISTENSEN ELIAS MAITSLAND (DEN)

*Seeded

Referees:			

Junior Kumite Male -55 kg

EKF Junior, Cadet & U21 Championships 2026 - Limassol, Spyros Kyprianou Athletic Center, Limassol, CYP

2026-02-07

Tatami
5 10:55

Pool
2/4

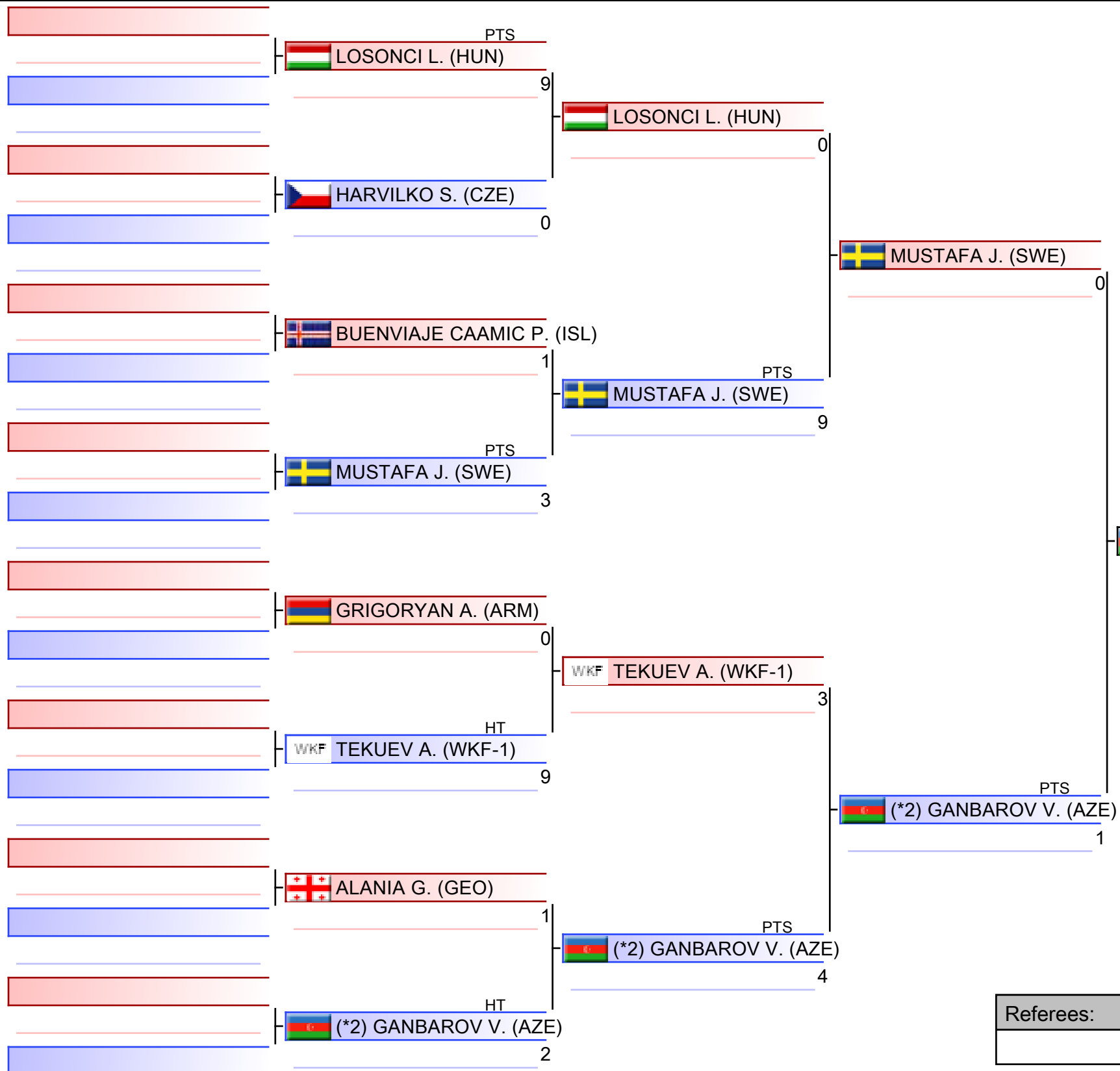

1. VIECHKANOV MAKSYM (UKR)
2. GANBAROV VUSAL (AZE)
3. TEKUEV ALYI (WKF-1)
3. MONDO BRANCHI MATTEO (ITA)
5. BALZARIS MIROSLAVS (LAT)
5. DAVID GABRIEL MUTU (ROU)
7. MUSTAFA JOSEF (SWE)
7. KRISTENSEN ELIAS MAITSLAND (DEN)

*Seeded

Referees:			

Junior Kumite Male -55 kg

EKF Junior, Cadet & U21 Championships 2026 - Limassol, Spyros Kyprianou Athletic Center, Limassol, CYP

2026-02-07

Tatami
6 10:15

Pool
3/4



WKF
EUROPE

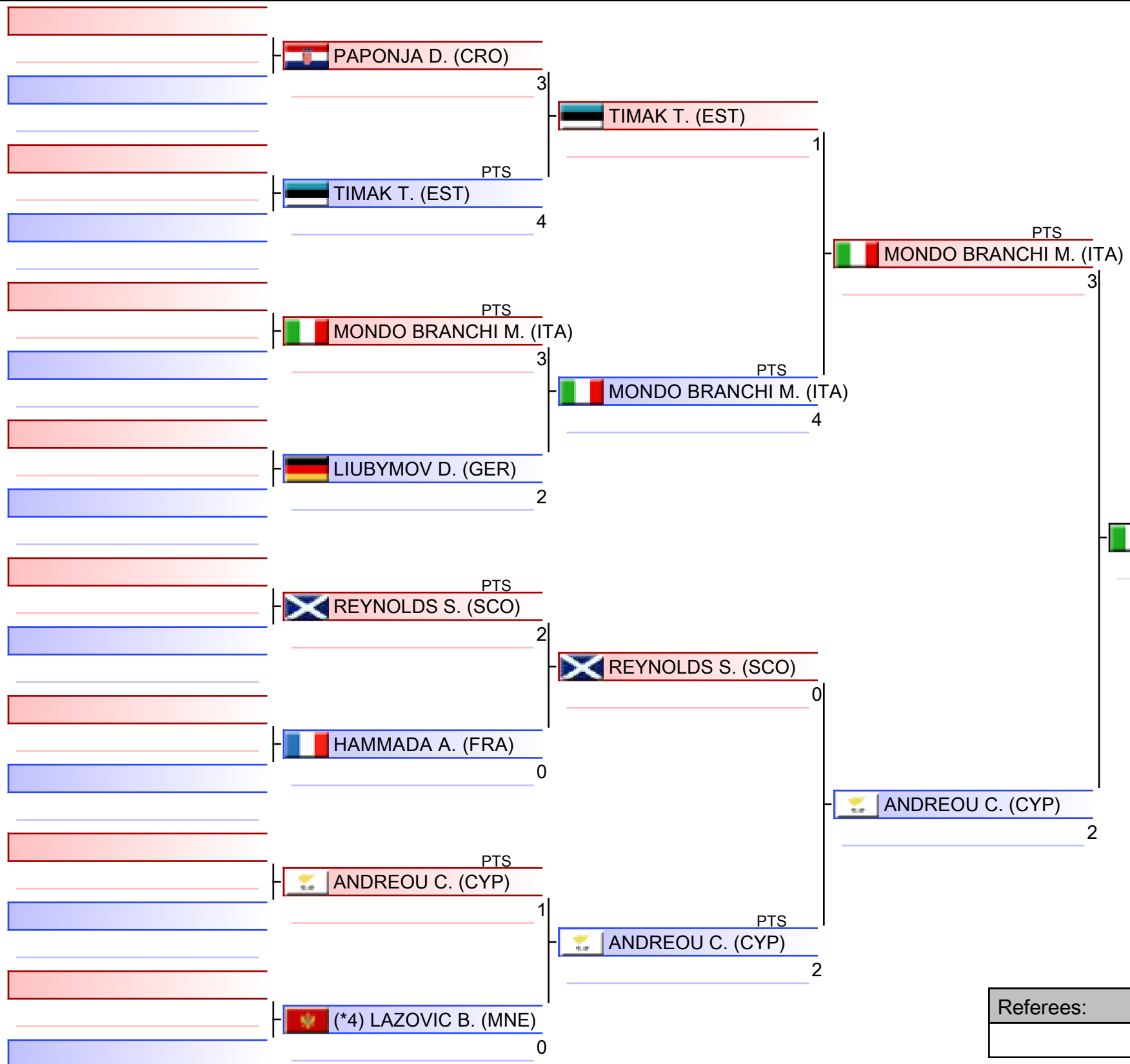

1. VIECHKANOV MAKSYM (UKR)
2. GANBAROV VUSAL (AZE)
3. TEKUEV ALYI (WKF-1)
3. MONDO BRANCHI MATTEO (ITA)
5. BALZARIS MIROSLAVS (LAT)
5. DAVID GABRIEL MUTU (ROU)
7. MUSTAFA JOSEF (SWE)
7. KRISTENSEN ELIAS MAITSLAND (DEN)

*Seeded

Referees:			

Junior Kumite Male -55 kg

EKF Junior, Cadet & U21 Championships 2026 - Limassol, Spyros Kyprianou Athletic Center, Limassol, CYP

2026-02-07

Tatami
6 10:55

Pool
4/4

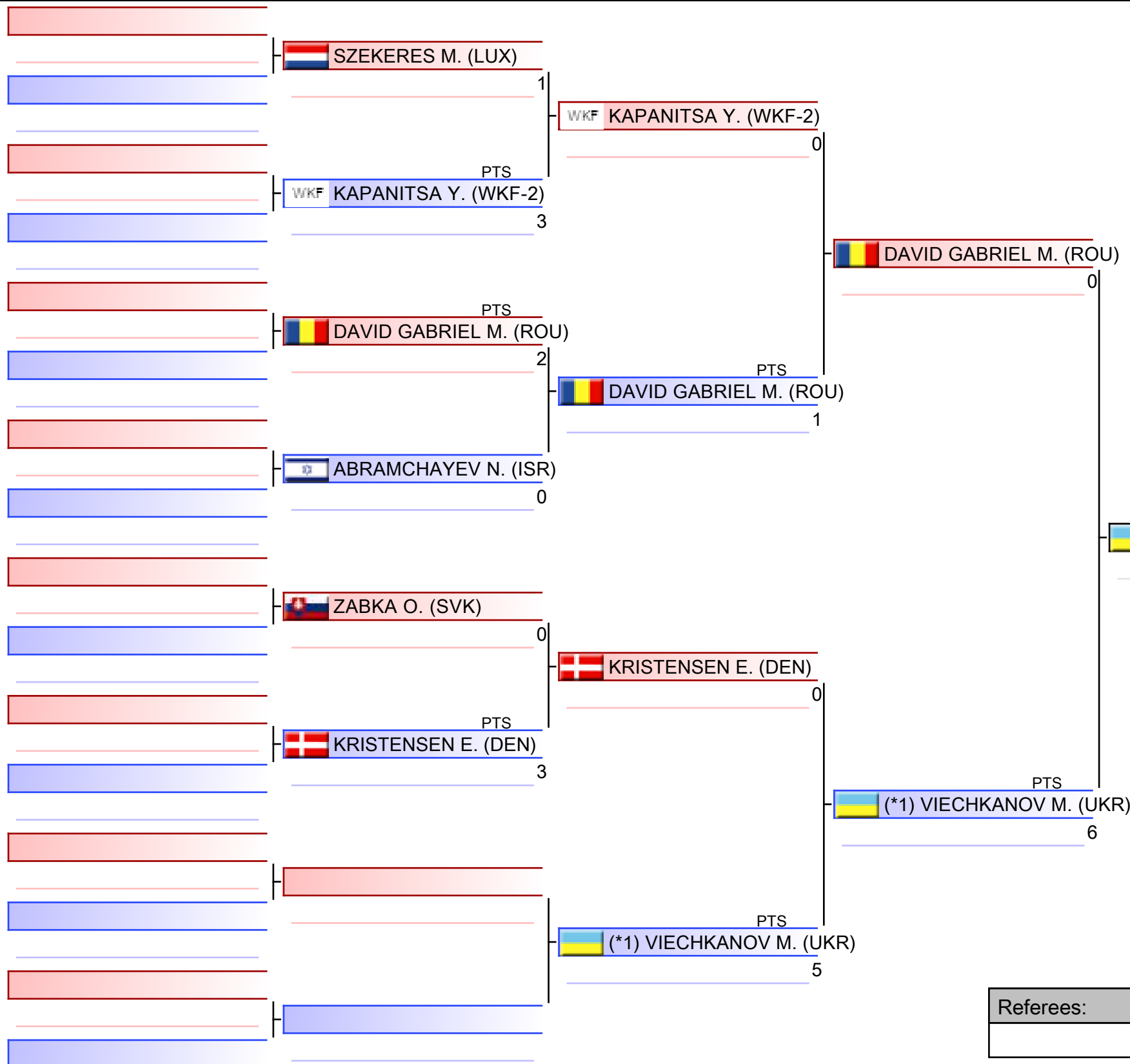

WKF
EUROPE

1. VIECHKANOV MAKSYM (UKR)
2. GANBAROV VUSAL (AZE)
3. TEKUEV ALYI (WKF-1)
3. MONDO BRANCHI MATTEO (ITA)
5. BALZARIS MIROSLAVS (LAT)
5. DAVID GABRIEL MUTU (ROU)
7. MUSTAFA JOSEF (SWE)
7. KRISTENSEN ELIAS MAITSLAND (DEN)

*Seeded

Referees:			

Pool winner-Junior Kumite Male -55 kg

EKF Junior, Cadet & U21 Championships 2026 - Limassol, Spyros Kyprianou Athletic Center, Limsassol, CYP

2026-02-07

Tatami
5 11:35

Pool
1/1



WKF
EUROPE

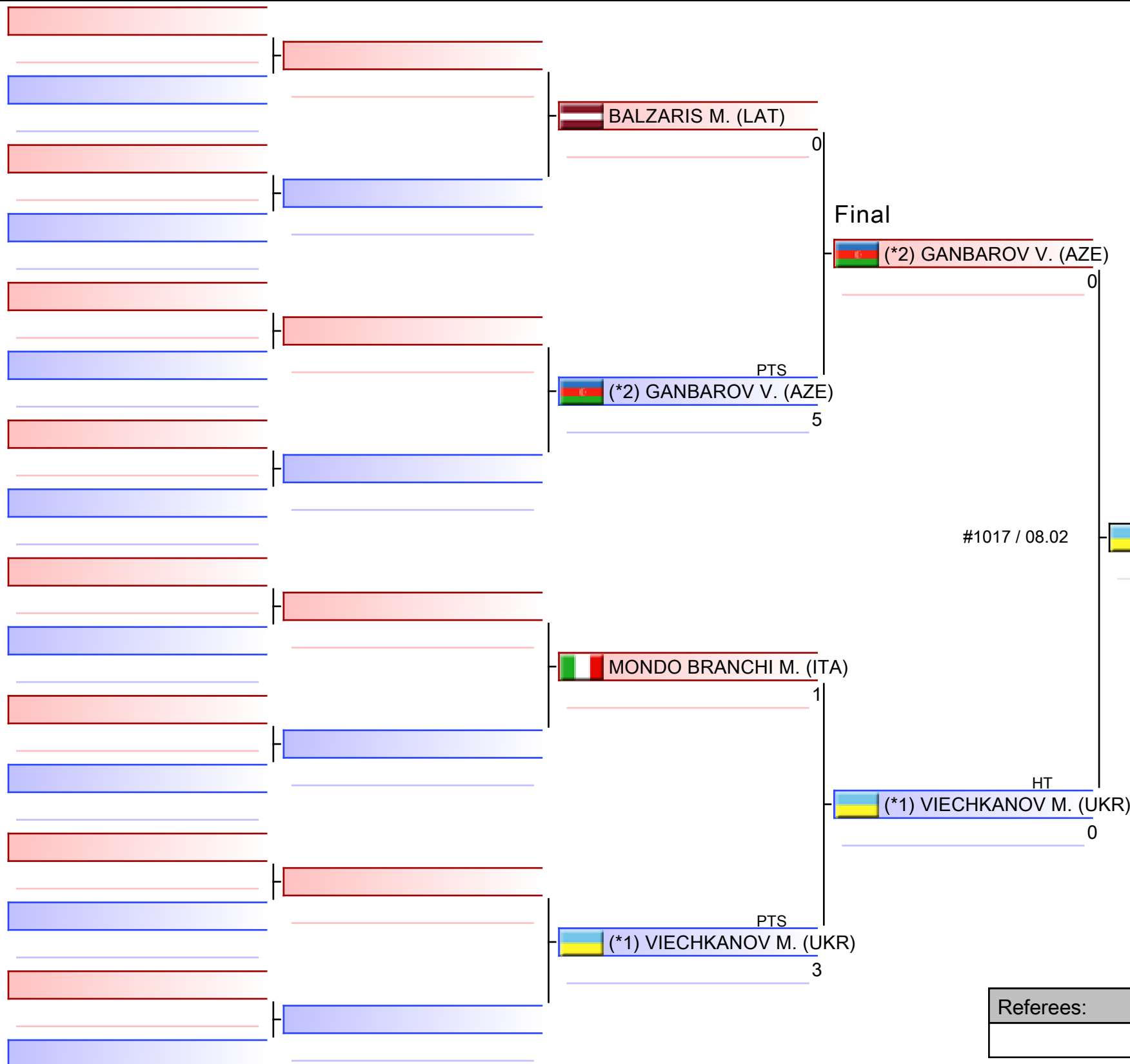

1. VIECHKANOV MAKSYM (UKR)
2. GANBAROV VUSAL (AZE)
3. TEKUEV ALYI (WKF-1)
3. MONDO BRANCHI MATTEO (ITA)
5. BALZARIS MIROSLAVS (LAT)
5. DAVID GABRIEL MUTU (ROU)
7. MUSTAFA JOSEF (SWE)
7. KRISTENSEN ELIAS MAITSLAND (DEN)

*Seeded

Referees:			

Junior Kumite Male -55 kg

EKF Junior, Cadet & U21 Championships 2026 - Limassol

2026-02-07

Tatami
6 17:40

Pool
1,2,3,4

(c)sportdata GmbH & Co KG 2000-2026 (2026-02-08 17:46) v 11.0.0 build 2 (2025-01-21 11:49 CET) License: SDIL TWG2025 (expire 2026-09-30)

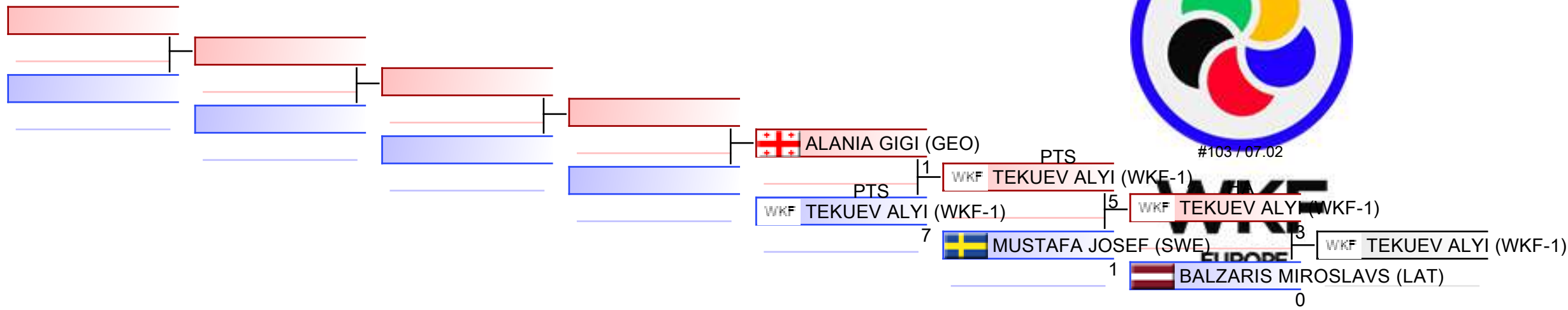

REPECHAGE: (1,2,3,4)

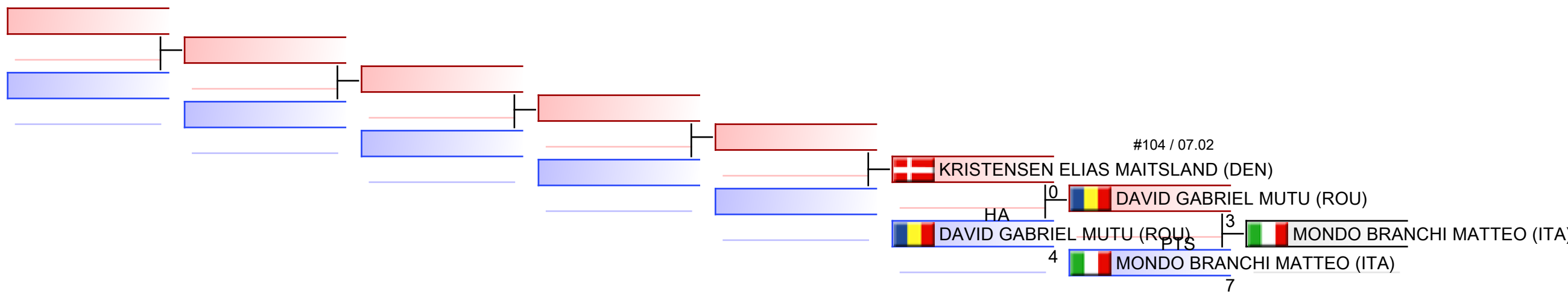

Referees:							
-----------	--	--	--	--	--	--	--



EKF Junior, Cadet & U21 Championships
2026 - Limassol - 2026-02-06



Official Results

Junior Kumite Male -55 kg			
1	VIECHKANOV MAKSYM		UKR - UKRAINE
2	GANBAROV VUSAL		AZE - AZERBAIJAN
3	TEKUEV ALYI	WKF	WKF-1 - WKF-1
3	MONDO BRANCHI MATTEO		ITA - ITALY
5	BALZARIS MIROSLAVS		LAT - LATVIA
5	DAVID GABRIEL MUTU		ROU - ROMANIA
7	MUSTAFA JOSEF		SWE - SWEDEN
7	KRISTENSEN ELIAS MAITSLAND		DEN - DENMARK
9	ALANIA GIGI		GEO - GEORGIA

JUNIOR KUMITE MALE -61 KG



EKF Junior, Cadet & U21 Championships 2026 - Lim..



ENTRIES BY WEIGHT CATEGORY

Junior Kumite Male -61 kg

As of 8 FEB 2026

Code	ID	Gender	Name	Seeding
ALB	ALB002731	M	HAZIZI ENIS	
ARM	ARM003062	M	HAKOBYAN GEVORG	
AZE	AZE02911	M	ABASOV RAVAN	
BEL	BEL02532	M	ALVES TORCATO MATHIS	
BIH	BIH04278	M	DIDIC ISMAIL	
BUL	BUL02474	M	BOYADZHIEV DIMITAR	
CRO	CRO2811	M	MABIC FILIP	2
CYP	CYP03049	M	NIKOLAOU GIORGOS	
CZE	CZE02420	M	HORNAK FILIP	
ENG	ENG003600	M	WATTS CONNOR	
ESP	ESP03893	M	MANSO ARNAL ADRIAN	
FRA	FRA03844	M	LAMBERT LEO	
GEO	GEO002911	M	KHATISASHVILI DAVIT	
GER	GER003980	M	NAMYSLIK FELIX	
GRE	GRE03033	M	KOUMPENAKIS VASILEIOS	3
HUN	HUN03003	M	KOVACS GERGELY KRISTOF	
IRL	IRL02843	M	PHELAN SEAN	
ISR	ISR02987	M	KUZMIN NIKITA	
ITA	ITA005573	M	APICELLA CARMINE	1
LAT	LAT003162	M	VIETRINS MAKSIMS	
LTU	LTU02522	M	VARANKINAS KAJUS	
LUX	LUX02468	M	AGOSTINO ENZO	
MDA	MDA02414	M	STOIANOV CHIRILL	
MKD	MKD03320	M	MARGARITOV CVETAN	
MLT	MLT02205	M	SANT ZACK	
MNE	MNE2473	M	DANILOVIC Balsa	
NED	NED03275	M	LEPEZ DEVON	4
POL	POL2955	M	OLICHWER NATAN	
POR	POR003317	M	VALONGO ANDRE	
ROU	ROU02714	M	TONCU CHRISTIAN EDUARD	
SCO	SCO02442	M	WOODS MAX	
SRB	SRB04204	M	AVRAMOVIC STRAHINJA	
SUI	SUI03114	M	ZECCA LUCAS	
SVK	SVK03132	M	PLICHTA BRUNO	
SWE	SWE003396	M	BOUGHIOU TOUFFIK	
UKR	UKR003918	M	KOSTENCHUK DANYLO	
WKF-1	AIN-1006364	M	RAIZER ARSENI	

Junior Kumite Male -61 kg

EKF Junior, Cadet & U21 Championships 2026 - Limassol, Spyros Kyprianou Athletic Center, Limassol, CYP

2026-02-07

Tatami
7 10:15

Pool
1/4

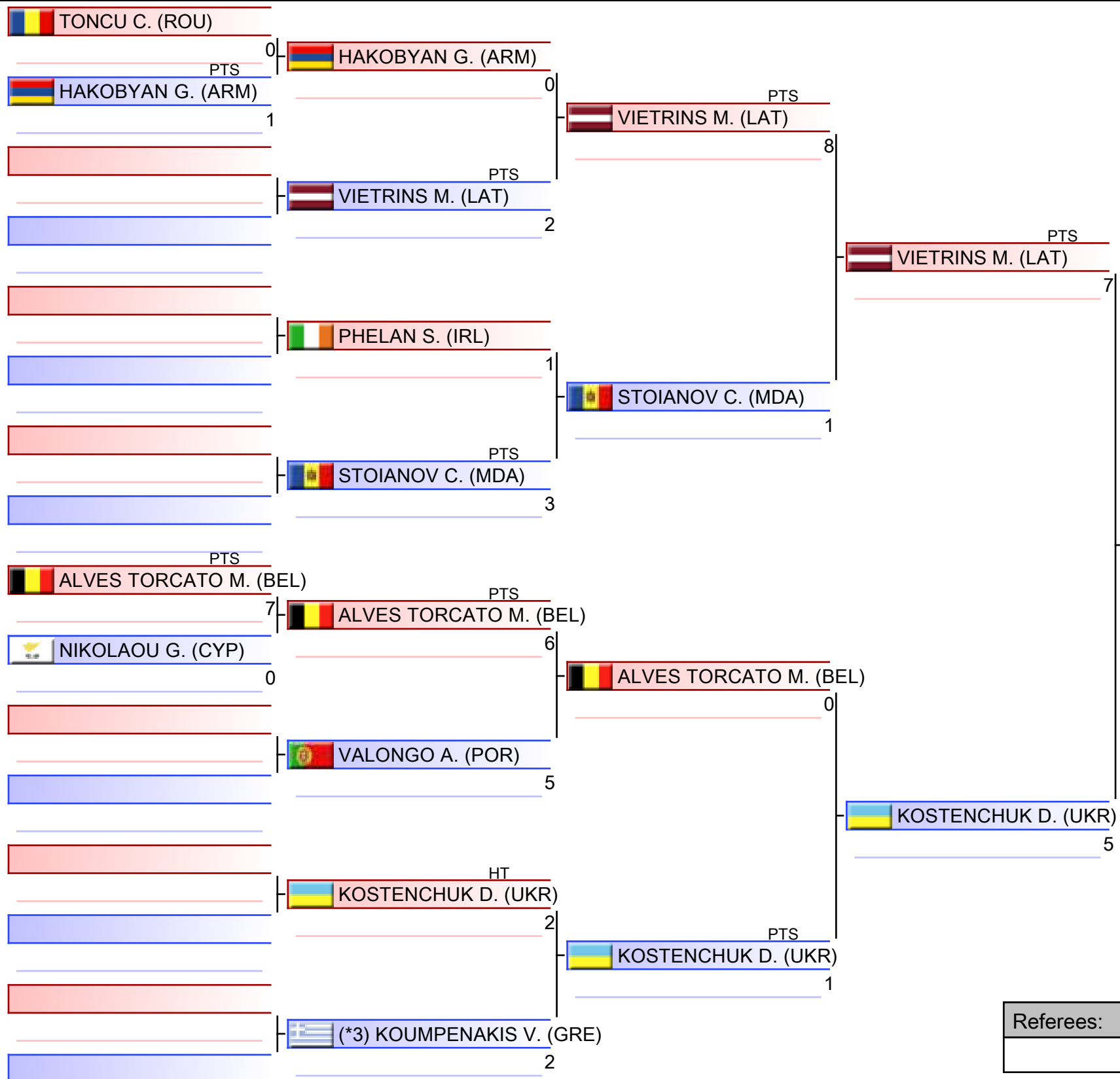

1. HORNAK FILIP (CZE)
2. MABIC FILIP (CRO)
3. ABASOV RAVAN (AZE)
3. DIDIC ISMAIL (BIH)
5. VIETRINS MAKSIMS (LAT)
5. LEPEZ DEVON (NED)
7. DANILOVIC Balsa (MNE)
7. MANSO ARNAL ADRIAN (ESP)

*Seeded

Referees:			

Junior Kumite Male -61 kg

EKF Junior, Cadet & U21 Championships 2026 - Limassol, Spyros Kyprianou Athletic Center, Limassol, CYP

2026-02-07

Tatami
7 11:05

Pool
2/4

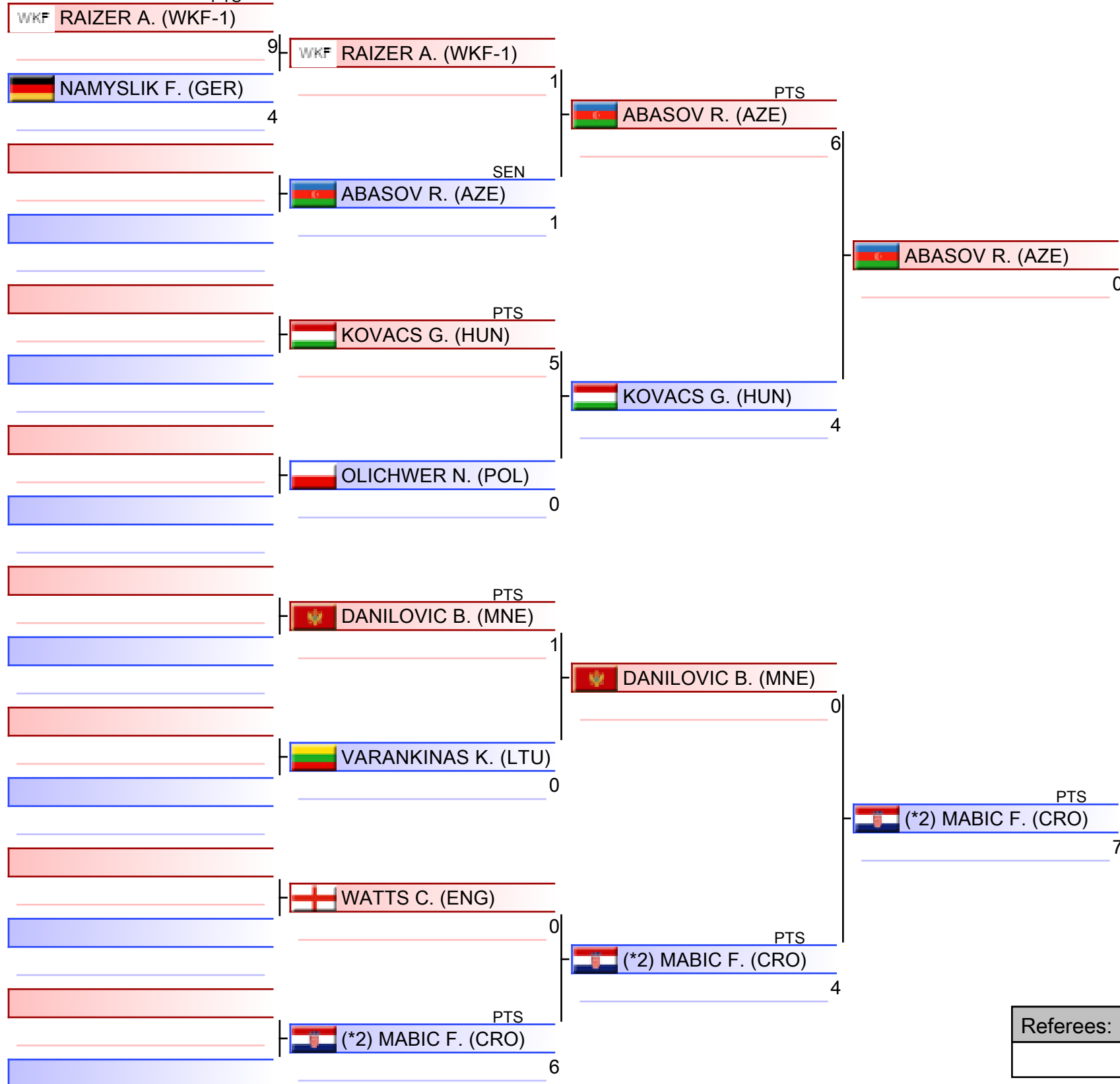

(*2) MABIC F. (CRO)

1. HORNAK FILIP (CZE)
2. MABIC FILIP (CRO)
3. ABASOV RAVAN (AZE)
3. DIDIC ISMAIL (BIH)
5. VIETRINS MAKSIMS (LAT)
5. LEPEZ DEVON (NED)
7. DANILOVIC Balsa (MNE)
7. MANSO ARNAL ADRIAN (ESP)

*Seeded

Referees:			

Junior Kumite Male -61 kg

EKF Junior, Cadet & U21 Championships 2026 - Limassol, Spyros Kyprianou Athletic Center, Limassol, CYP

2026-02-07

Tatami
8 10:15

Pool
3/4

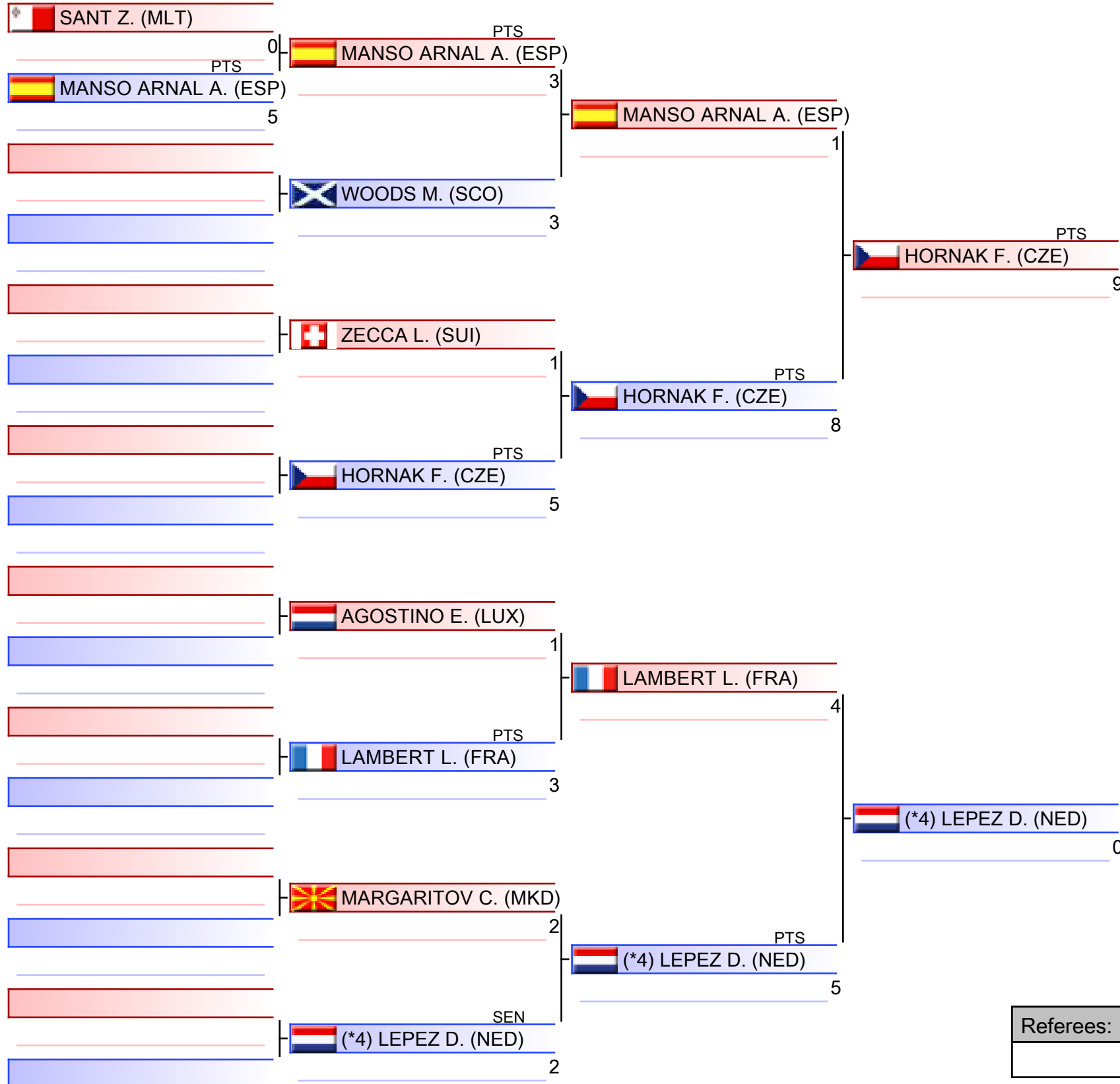

1. HORNAK FILIP (CZE)
2. MABIC FILIP (CRO)
3. ABASOV RAVAN (AZE)
3. DIDIC ISMAIL (BIH)
5. VIETRINS MAKSIMS (LAT)
5. LEPEZ DEVON (NED)
7. DANILOVIC Balsa (MNE)
7. MANSO ARNAL ADRIAN (ESP)

*Seeded

Referees:			

Junior Kumite Male -61 kg

EKF Junior, Cadet & U21 Championships 2026 - Limassol, Spyros Kyprianou Athletic Center, Limassol, CYP

2026-02-07

Tatami
8 11:00

Pool
4/4

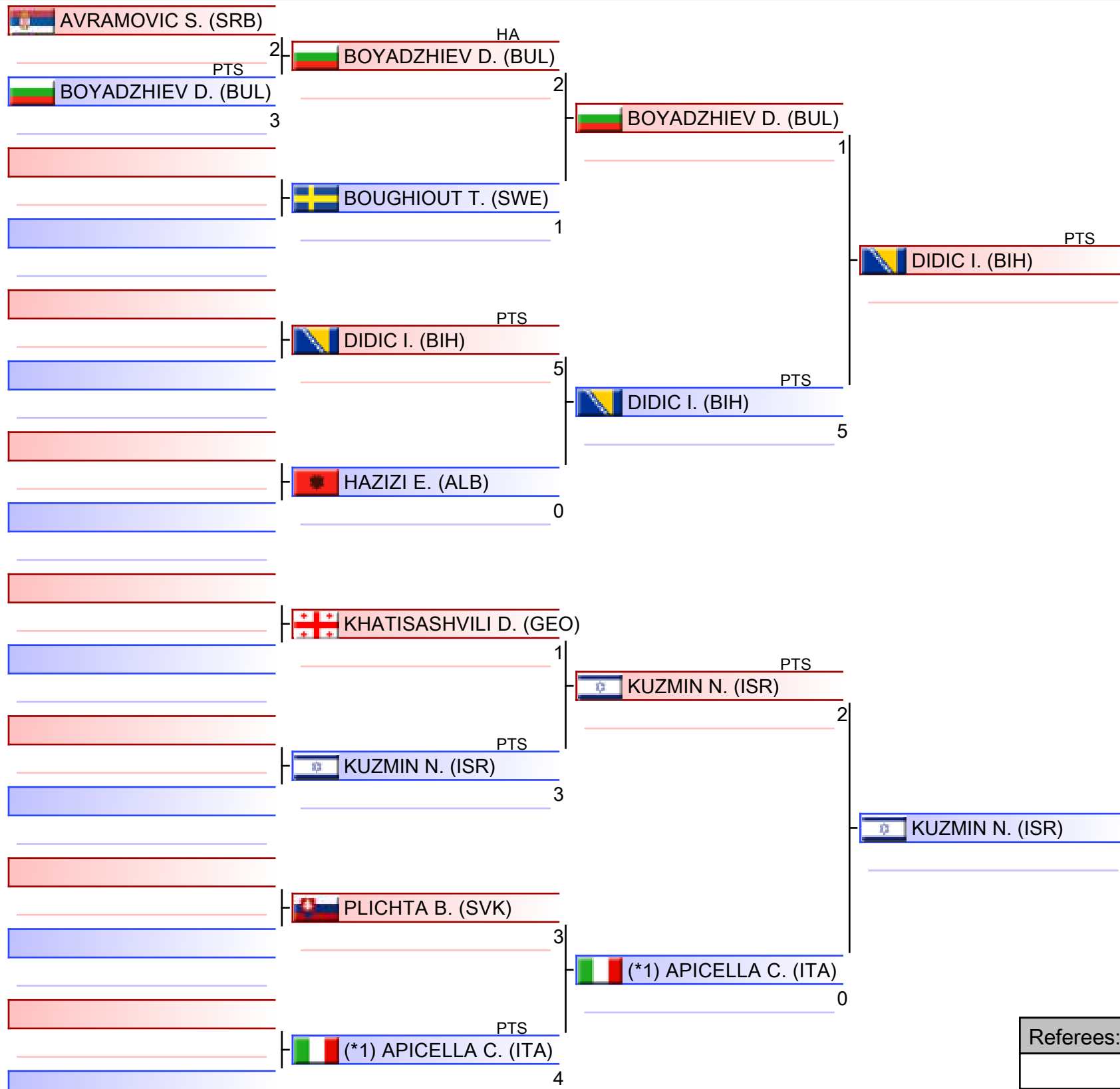

WKF
EUROPE

1. HORNAK FILIP (CZE)
2. MABIC FILIP (CRO)
3. ABASOV RAVAN (AZE)
3. DIDIC ISMAIL (BIH)
5. VIETRINS MAKSIMS (LAT)
5. LEPEZ DEVON (NED)
7. DANILOVIC Balsa (MNE)
7. MANSO ARNAL ADRIAN (ESP)

*Seeded

Referees:			

Pool winner-Junior Kumite Male -61 kg

EKF Junior, Cadet & U21 Championships 2026 - Limassol, Spyros Kyprianou Athletic Center, Limassol, CYP

2026-02-07

Tatami
7 11:50

Pool
1/1



WKF
EUROPE

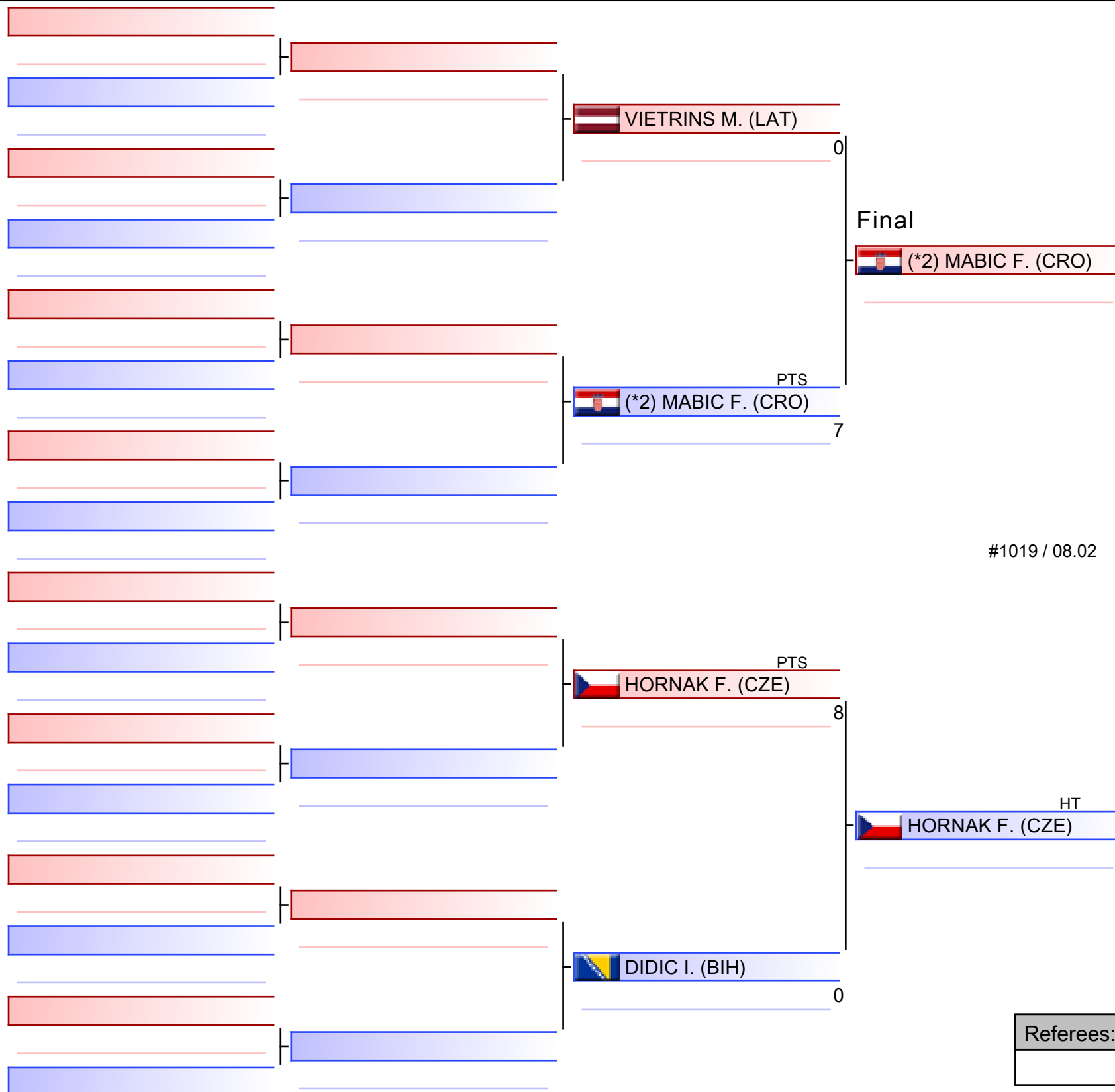

1. HORNAK FILIP (CZE)
2. MABIC FILIP (CRO)
3. ABASOV RAVAN (AZE)
3. DIDIC ISMAIL (BIH)
5. VIETRINS MAKSIMS (LAT)
5. LEPEZ DEVON (NED)
7. DANILOVIC BALSA (MNE)
7. MANSO ARNAL ADRIAN (ESP)

*Seeded

Referees:			

Junior Kumite Male -61 kg

EKF Junior, Cadet & U21 Championships 2026 - Limassol

2026-02-07

Tatami

2 17:30

Pool

1,2,3,4

(c)sportdata GmbH & Co KG 2000-2026 (2026-02-08 17:46) v 11.0.0 build 2 (2025-01-21 11:49 CET) License: SDIL TWG2025 (expire 2026-09-30)

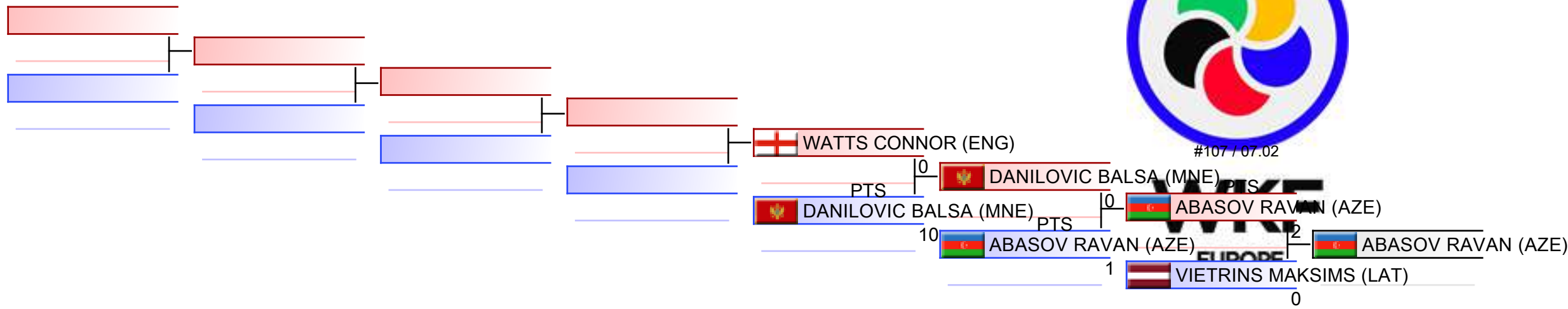

REPECHAGE: (1,2,3,4)

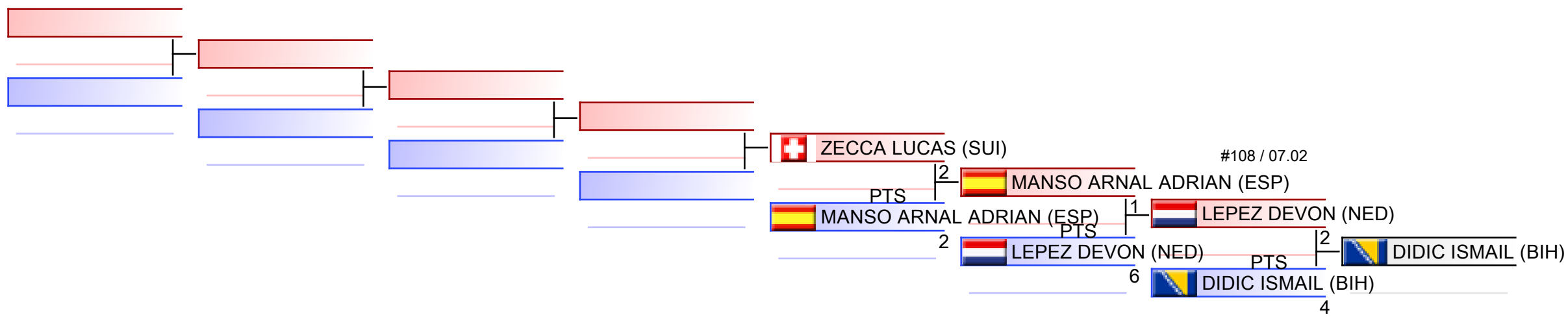

Referees:							
-----------	--	--	--	--	--	--	--



EKF Junior, Cadet & U21 Championships
2026 - Limassol - 2026-02-06



Official Results

Junior Kumite Male -61 kg			
1	HORNAK FILIP		CZE - CZECH REPUBLIC
2	MABIC FILIP		CRO - CROATIA
3	ABASOV RAVAN		AZE - AZERBAIJAN
3	DIDIC ISMAIL		BIH - BOSNIA AND HERZEGOVINA
5	VIETRINS MAKSIMS		LAT - LATVIA
5	LEPEZ DEVON		NED - NETHERLANDS
7	DANILOVIC Balsa		MNE - MONTENEGRO
7	MANSO ARNAL ADRIAN		ESP - SPAIN
9	WATTS CONNOR		ENG - ENGLAND
9	ZECCA LUCAS		SUI - SWITZERLAND

JUNIOR KUMITE MALE -68 KG



EKF Junior, Cadet & U21 Championships 2026 - Lim..



ENTRIES BY WEIGHT CATEGORY

Junior Kumite Male -68 kg

As of 8 FEB 2026

Code	ID	Gender	Name	Seeding
ALB	ALB002733	M	RUSTEMI ENDRI	
ARM	ARM02374	M	PETROSYAN TARON	
AUT	AUT02780	M	FLEISCH TOBIAS	
AZE	AZE02606	M	MALIKOV ALADDIN	
BEL	BEL02528	M	ZOUEINI RAYAN	1
BIH	BIH04281	M	MUJIC VEDAD	
BUL	BUL02476	M	MIHAYLOV NIKOLA	
CRO	CRO03364	M	SLUKIC PETAR	3
CYP	CYP02832	M	ANTONIOU IOEL	
CZE	CZE02492	M	SIMOTA DAVID	
DEN	DEN002954	M	UDAHL MATHIAS EK	
ENG	ENG003614	M	JOHNSON-CAMPBELL AARON	
ESP	ESP004317	M	LEON MUNOZ OIER	
EST	EST02601	M	ILJENKO ILJA	
FIN	FIN002718	M	SIMONEN RENE	
FRA	FRA03845	M	TAKLIT ANIS	
GEO	GEO02857	M	ABULADZE NIKOLOZ	
GER	GER03306	M	NIEDERELZ TIM	
GRE	GRE02848	M	MORAITIS ANGELOS	
HUN	HUN003515	M	FELSZNER ERIK	
IRL	IRL03044	M	HENEGHAN ALEX	
ISL	ISL002526	M	JONSSON ARON BUILAM	
ISR	ISR003135	M	YAKHEDS ADAM	
ITA	ITA05400	M	TOMMASINO ALMERICO	2
LAT	LAT002964	M	SOROHOVS KIRILLS	
LTU	LTU002701	M	NOLIUS VINGAUDAS	
LUX	LUX02427	M	TODOROVIC FILIP	
MDA	MDA02232	M	DOBROVOLSCHI DENIS	
MKD	MKD03367	M	KURTANOVIC DARIN	
MLT	MLT02203	M	PSAILA KAYDEN	
MNE	MNE2469	M	SALJIU JUSUF	
POL	POL2909	M	KASPRZAK PASCAL	
POR	POR003512	M	COSTA DAVID	
ROU	ROU03231	M	CRIVAT STEFAN	
SLO	SLO003053	M	SEDONJA MATIJA	
SRB	SRB03744	M	MILUTINOVIC MARKO	
SUI	SUI02734	M	KARLEN THEO	4
SVK	SVK003406	M	PASNISIN MAROS	
UKR	UKR03565	M	STANKOV SERHII	
WKF-1	WKF-1006808	M	LIKHANOV ANDREI	

Junior Kumite Male -68 kg

EKF Junior, Cadet & U21 Championships 2026 - Limassol, Spyros Kyprianou Athletic Center, Limassol, CYP

2026-02-07

Tatami
1 11:30

Pool
1/4

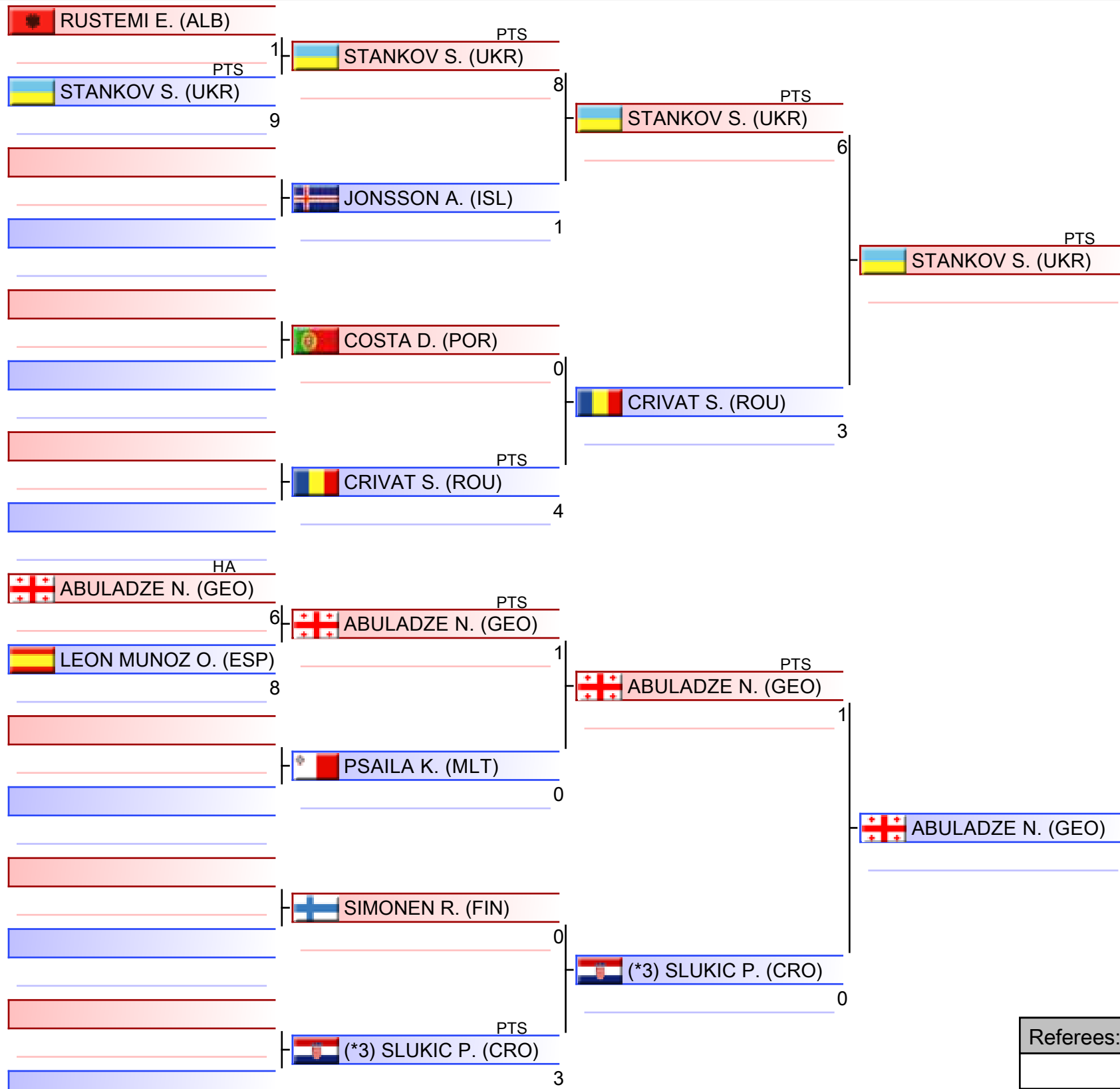

WKF
EUROPE

1. MALIKOV ALADDIN (AZE)
2. STANKOV SERHII (UKR)
3. TAKLIT ANIS (FRA)
3. ABULADZE NIKOLOZ (GEO)
5. SIMOTA DAVID (CZE)
5. TOMMASINO ALMERICO (ITA)
7. MIHAYLOV NIKOLA (BUL)
7. JONSSON ARON BUILAM (ISL)

*Seeded

Referees:			

Junior Kumite Male -68 kg

EKF Junior, Cadet & U21 Championships 2026 - Limassol, Spyros Kyprianou Athletic Center, Limassol, CYP

2026-02-07

Tatami
1 12:20

Pool
2/4

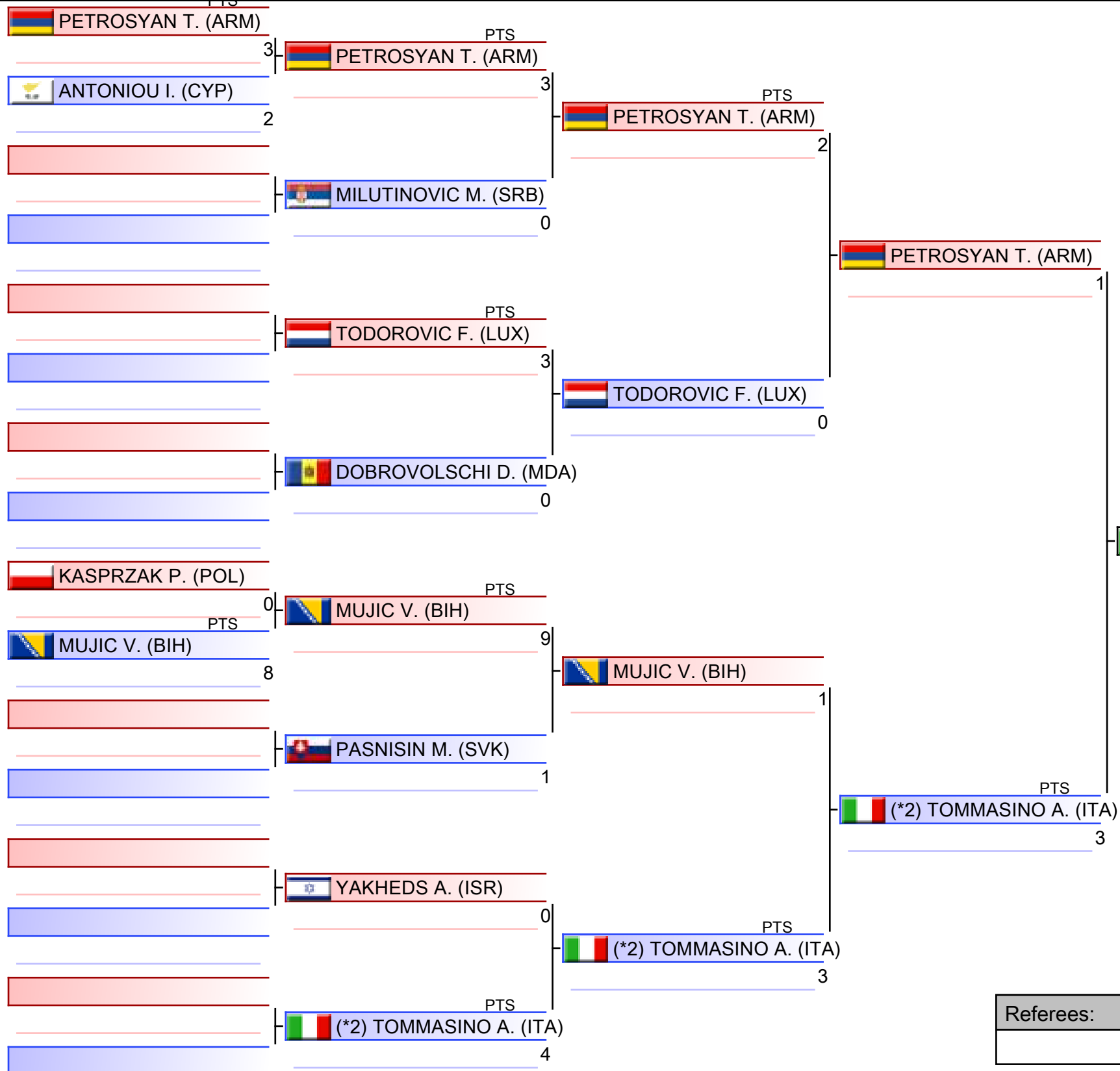

(*2) TOMMASINO A. (ITA)

1. MALIKOV ALADDIN (AZE)
2. STANKOV SERHII (UKR)
3. TAKLIT ANIS (FRA)
3. ABULADZE NIKOLOZ (GEO)
5. SIMOTA DAVID (CZE)
5. TOMMASINO ALMERICCO (ITA)
7. MIHAYLOV NIKOLA (BUL)
7. JONSSON ARON BUILAM (ISL)

*Seeded

Referees:			

Junior Kumite Male -68 kg

EKF Junior, Cadet & U21 Championships 2026 - Limassol, Spyros Kyprianou Athletic Center, Limassol, CYP

2026-02-07

Tatami
2 11:25

Pool
3/4

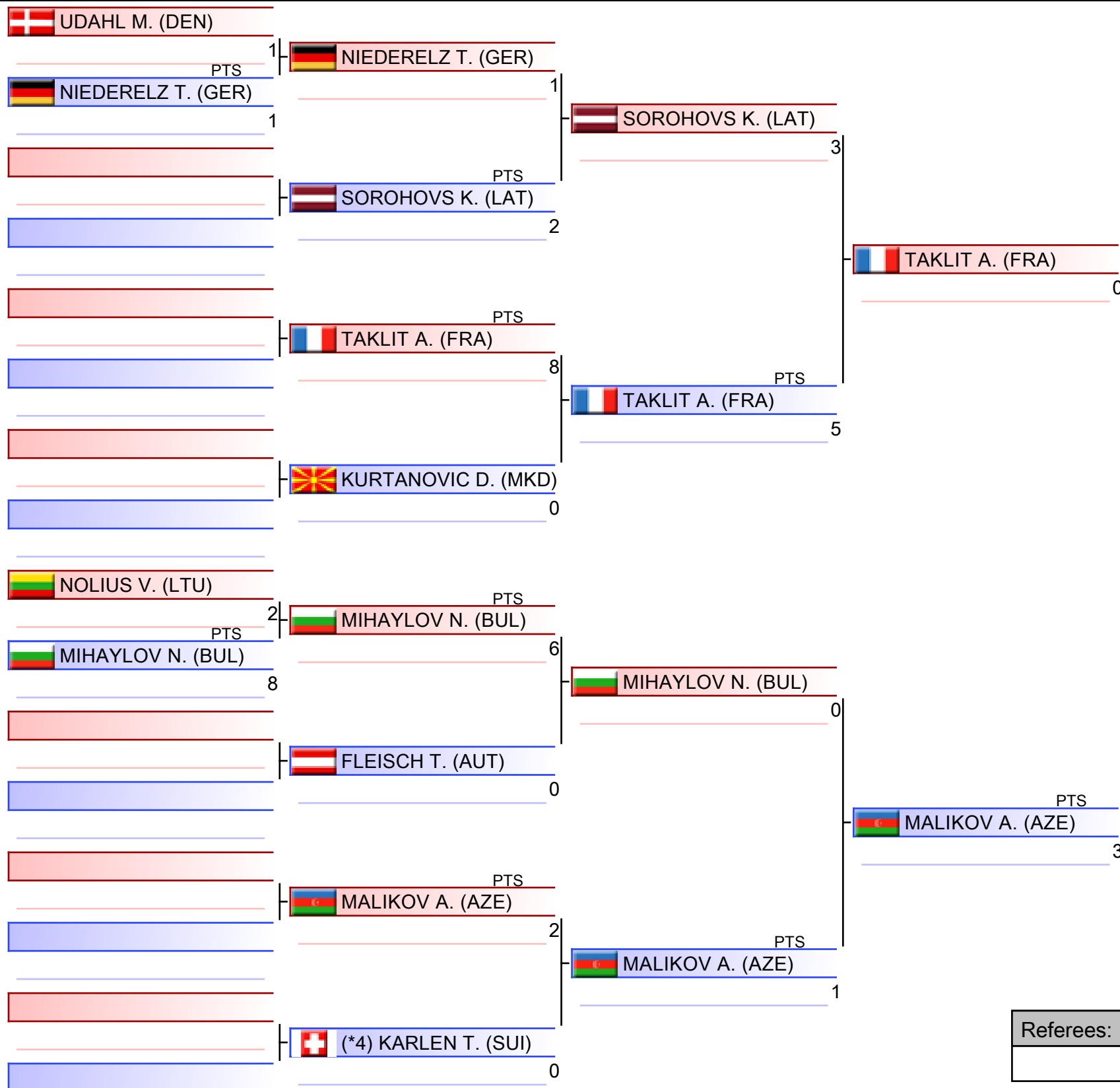

1. MALIKOV ALADDIN (AZE)
2. STANKOV SERHII (UKR)
3. TAKLIT ANIS (FRA)
3. ABULADZE NIKOLOZ (GEO)
5. SIMOTA DAVID (CZE)
5. TOMMASINO ALMERICCO (ITA)
7. MIHAYLOV NIKOLA (BUL)
7. JONSSON ARON BUILAM (ISL)

*Seeded

Referees:			

Junior Kumite Male -68 kg

EKF Junior, Cadet & U21 Championships 2026 - Limassol, Spyros Kyprianou Athletic Center, Limassol, CYP

2026-02-07

Tatami
2 12:15

Pool
4/4

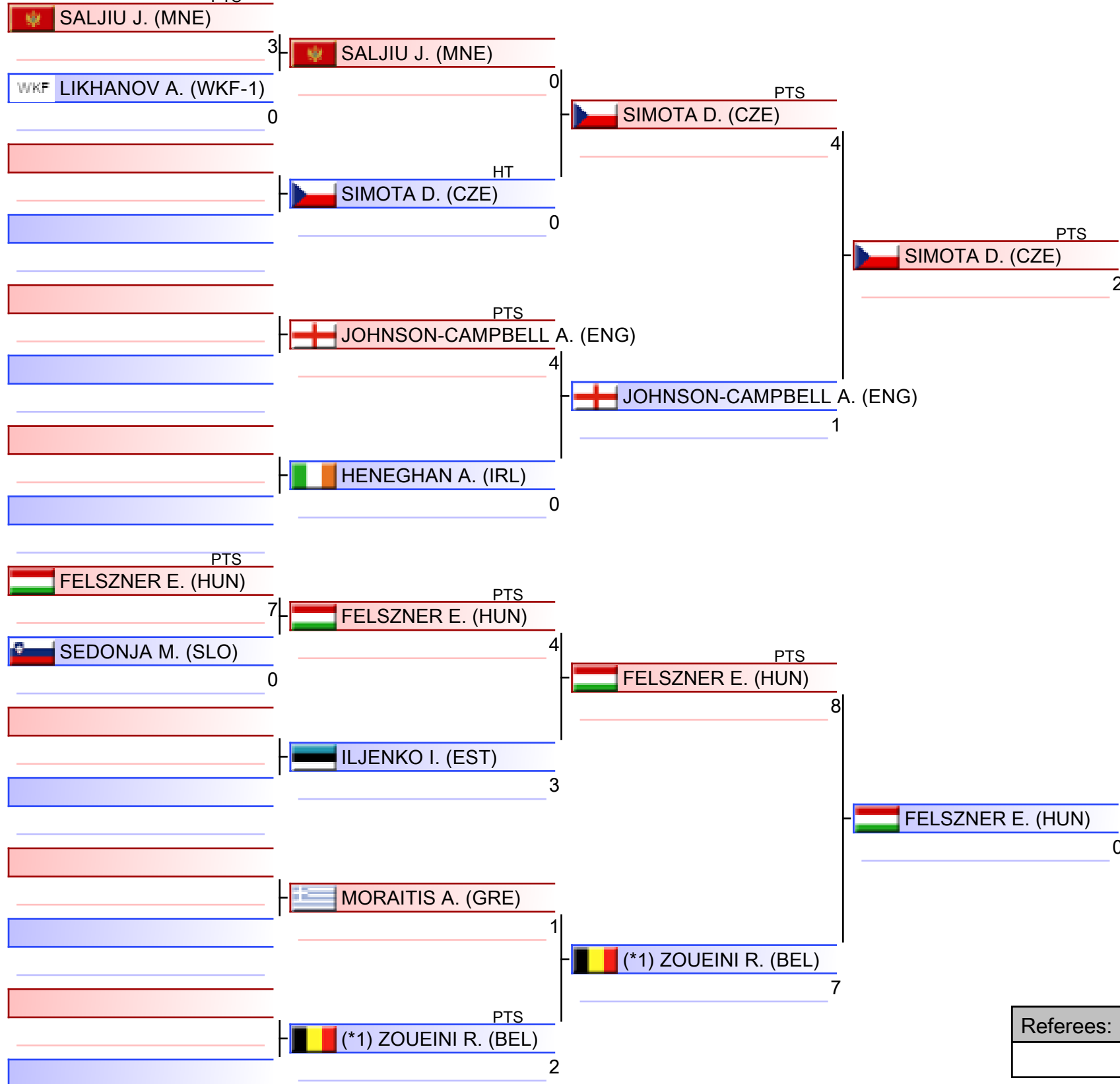

WKF
EUROPE

1. MALIKOV ALADDIN (AZE)
2. STANKOV SERHII (UKR)
3. TAKLIT ANIS (FRA)
3. ABULADZE NIKOLOZ (GEO)
5. SIMOTA DAVID (CZE)
5. TOMMASINO ALMERICO (ITA)
7. MIHAYLOV NIKOLA (BUL)
7. JONSSON ARON BUILAM (ISL)

*Seeded

Referees:			

Pool winner-Junior Kumite Male -68 kg

EKF Junior, Cadet & U21 Championships 2026 - Limassol, Spyros Kyprianou Athletic Center, Limsassol, CYP

2026-02-07

Tatami
1 13:10

Pool
1/1

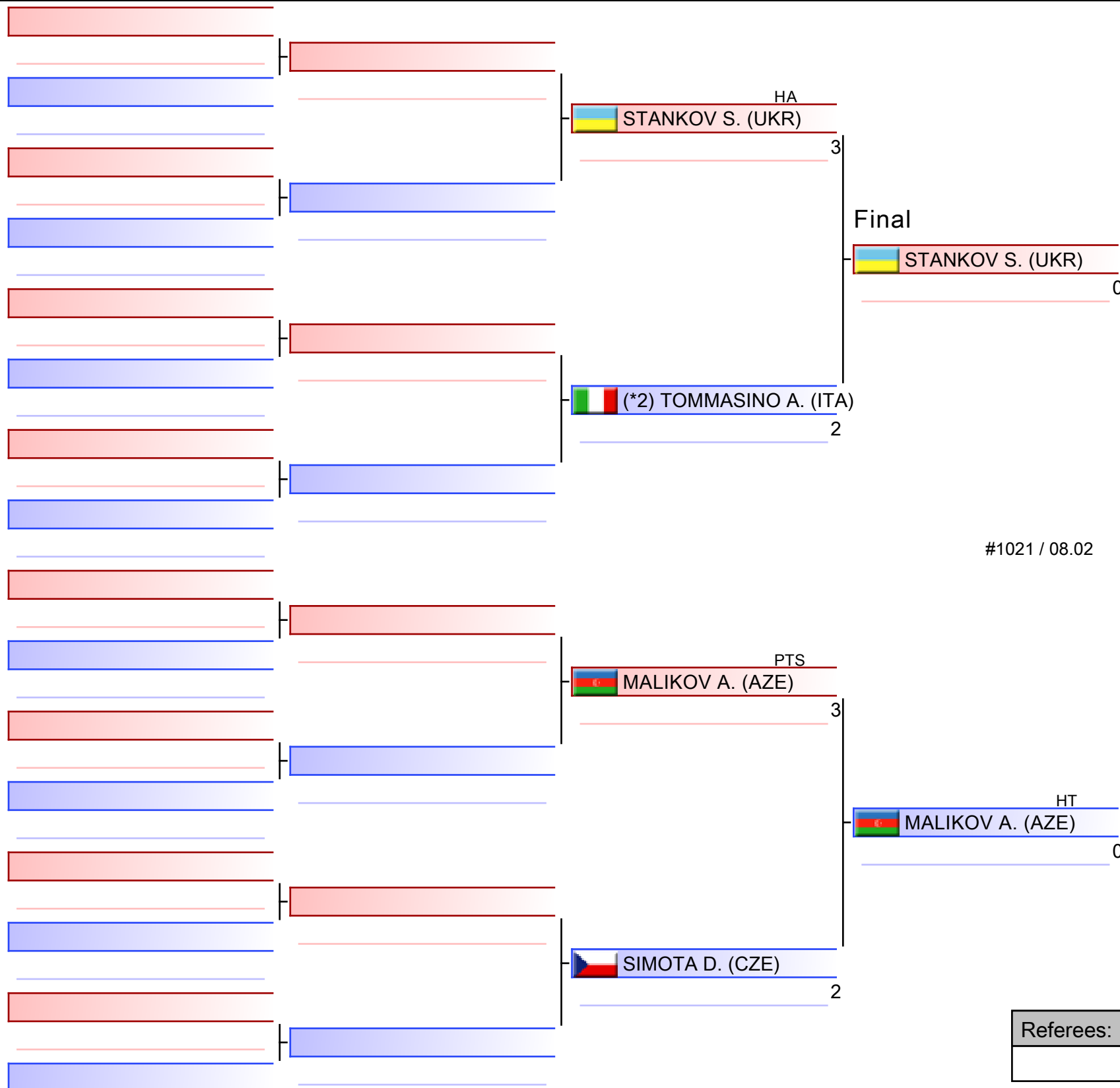

WKF
EUROPE

#1021 / 08.02

MALIKOV A. (AZE)

1. MALIKOV ALADDIN (AZE)
2. STANKOV SERHII (UKR)
3. TAKLIT ANIS (FRA)
3. ABULADZE NIKOLOZ (GEO)
5. SIMOTA DAVID (CZE)
5. TOMMASINO ALMERICO (ITA)
7. MIHAYLOV NIKOLA (BUL)
7. JONSSON ARON BUILAM (ISL)

*Seeded

Referees:			

Junior Kumite Male -68 kg

EKF Junior, Cadet & U21 Championships 2026 - Limassol

2026-02-07

Tatami
3 17:45

Pool
1,2,3,4

(c)sportdata GmbH & Co KG 2000-2026 (2026-02-08 17:46) v 11.0.0 build 2 (2025-01-21 11:49 CET) License: SDIL TWG2025 (expire 2026-09-30)

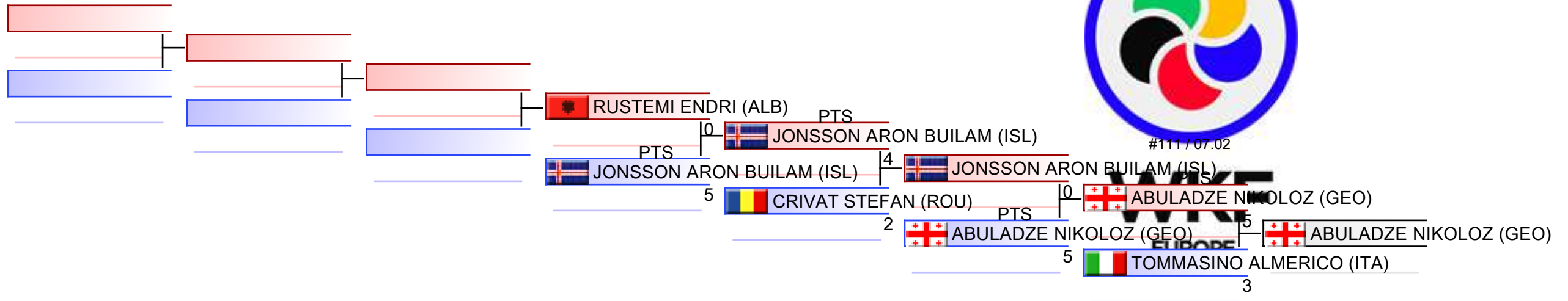

REPECHAGE: (1,2,3,4)

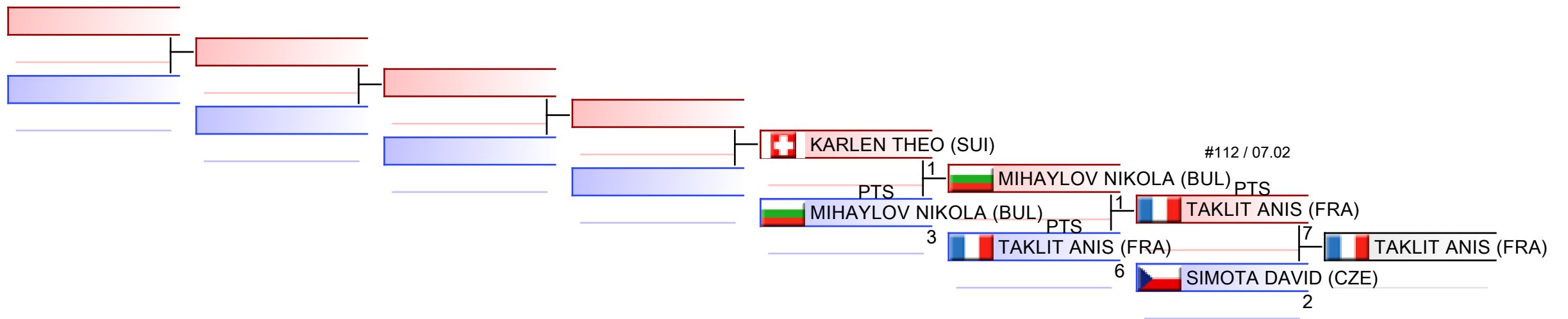

Referees:							



EKF Junior, Cadet & U21 Championships
2026 - Limassol - 2026-02-06



Official Results

Junior Kumite Male -68 kg			
1	MALIKOV ALADDIN		AZE - AZERBAIJAN
2	STANKOV SERHII		UKR - UKRAINE
3	TAKLIT ANIS		FRA - FRANCE
3	ABULADZE NIKOLOZ		GEO - GEORGIA
5	SIMOTA DAVID		CZE - CZECH REPUBLIC
5	TOMMASINO ALMERICO		ITA - ITALY
7	MIHAYLOV NIKOLA		BUL - BULGARIA
7	JONSSON ARON BUILAM		ISL - ICELAND
9	KARLEN THEO		SUI - SWITZERLAND
9	CRIVAT STEFAN		ROU - ROMANIA
11	RUSTEMI ENDRI		ALB - ALBANIA

JUNIOR KUMITE MALE -76 KG



EKF Junior, Cadet & U21 Championships 2026 - Lim..



ENTRIES BY WEIGHT CATEGORY

Junior Kumite Male -76 kg

As of 8 FEB 2026

Code	ID	Gender	Name	Seeding
ALB	ALB02271	M	MUCA ARMANDO	
ARM	ARM02638	M	VARDANYAN HOVIK	
AUT	AUT02781	M	PLATISA PASCAL	3
AZE	AZE03350	M	HAJIZADA NURAN	
BEL	BEL003220	M	TSHIBASSU-SONA ELIE-CHRISTOPHER-ALEX	
BIH	BIH2669	M	ARNAUTOVIC ALI	
BUL	BUL02621	M	TSANEV NIKOLAY	
CRO	CRO03718	M	BIRAC NIKOLA	2
CYP	CYP02826	M	ANTONIOU NIKOLAS	
CZE	CZE003003	M	FAJT JAKUB	
DEN	DEN002999	M	PEJTERSEN JOHAN MARKMANN	
ENG	ENG003606	M	FAYIK LOUIE	
ESP	ESP03892	M	DIEGO ROLDAN RUBEN	
FIN	FIN002862	M	KREUS PETRUS	
FRA	FRA04087	M	DOULI MATHIS	
GEO	GEO002914	M	ARUTINOV ARTIOM	
GER	GER003924	M	MUELLER MARIUS	
GRE	GRE02762	M	PAPAGRIGORIOU KOSMAS	
HUN	HUN003371	M	RUZSINSZKI BALAZS	
IRL	IRL02945	M	WONG-LYE CHRISTOPHER CHUNG YIN	
ISL	ISL002527	M	AGNESAR GUNNARSSON OSKAR INGI	
ISR	ISR003102	M	YAKHEDS YAN	
ITA	ITA05399	M	CARRARESI ALESSANDRO	
LAT	LAT003155	M	SKALITIS KRISTAPS	
LUX	LUX02316	M	PIERANTONI MATTEO	
MKD	MKD03024	M	PASHOV DJEM	
MNE	MNE2429	M	ARIFAJ ANES	1
NED	NED03276	M	BLUMINK LEVY	
POL	POL05610	M	WOJARSKI WIKTOR	
POR	POR03188	M	JERONIMO VALENTIM	
ROU	ROU03715	M	DOLOMAN MIHAI CRISTIAN	
SLO	SLO02891	M	BAUMAN GAL	
SRB	SRB03370	M	KAPLAREVIC NIKOLA	
SUI	SUI003706	M	SOLIARYK PLATON	
SVK	SVK02875	M	TURCANIK RICHARD	4
SWE	SWE003127	M	HASSAS JACOB	
UKR	UKR003919	M	MATSERUK OLEKSANDR	
WKF-1	WKF-1006782	M	MAGOMEDALIEV ABDULKADIR	

Junior Kumite Male -76 kg

EKF Junior, Cadet & U21 Championships 2026 - Limassol, Spyros Kyprianou Athletic Center, Limassol, CYP

2026-02-07

Tatami
3 11:35

Pool
1/4

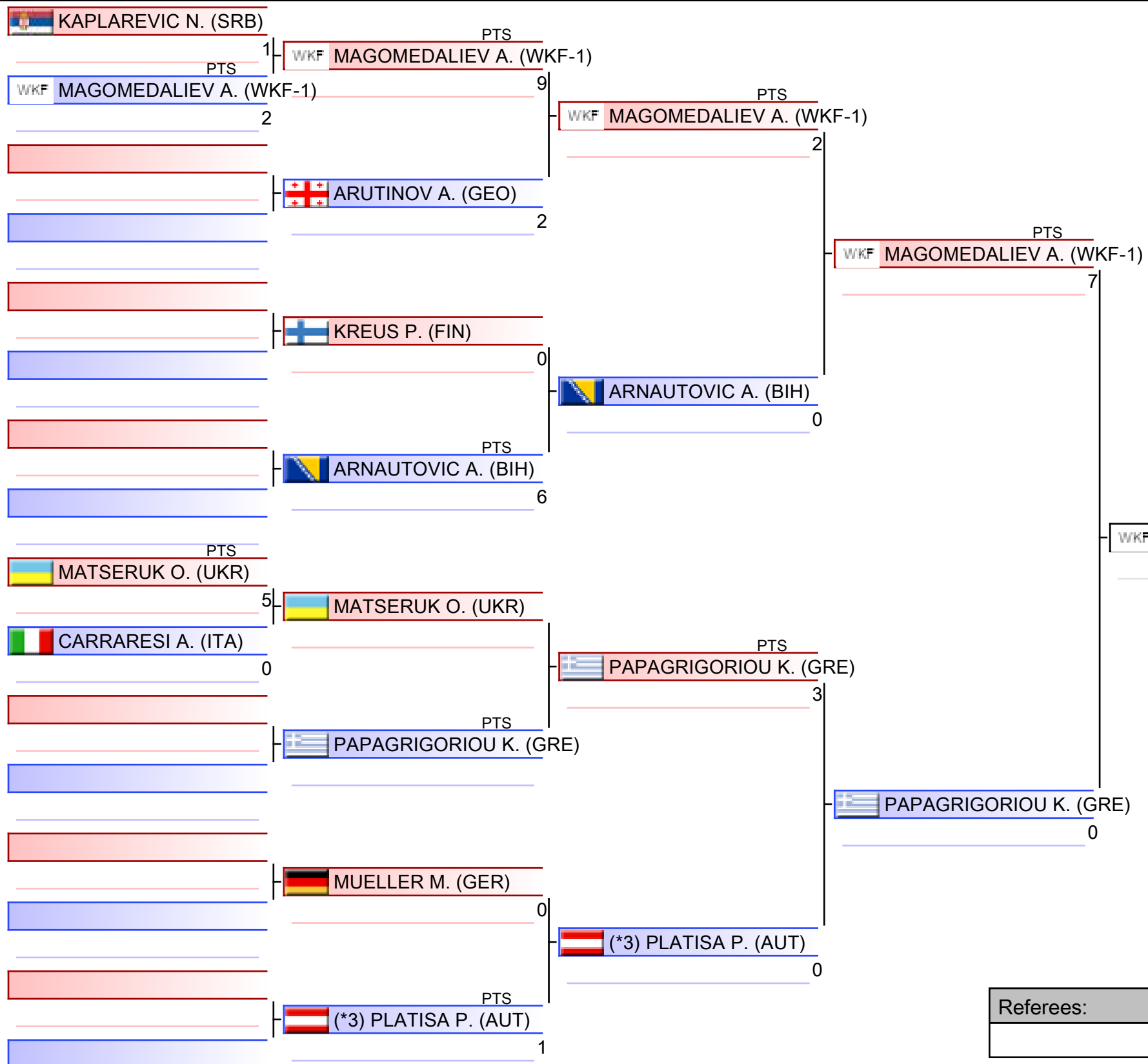

1. TURCANIK RICHARD (SVK)
2. DOLOMAN MIHAI CRISTIAN (ROU)
3. ARIFAJ ANES (MNE)
3. MAGOMEDALIEV ABDULKADIR (WKF-1)
5. TSANEV NIKOLAY (BUL)
5. BIRAC NIKOLA (CRO)
7. PASHOV DJEM (MKD)
7. RUZSINSZKI BALAZS (HUN)

*Seeded

Referees:			

Junior Kumite Male -76 kg

EKF Junior, Cadet & U21 Championships 2026 - Limassol, Spyros Kyprianou Athletic Center, Limassol, CYP

2026-02-07

Tatami
3 12:25

Pool
2/4

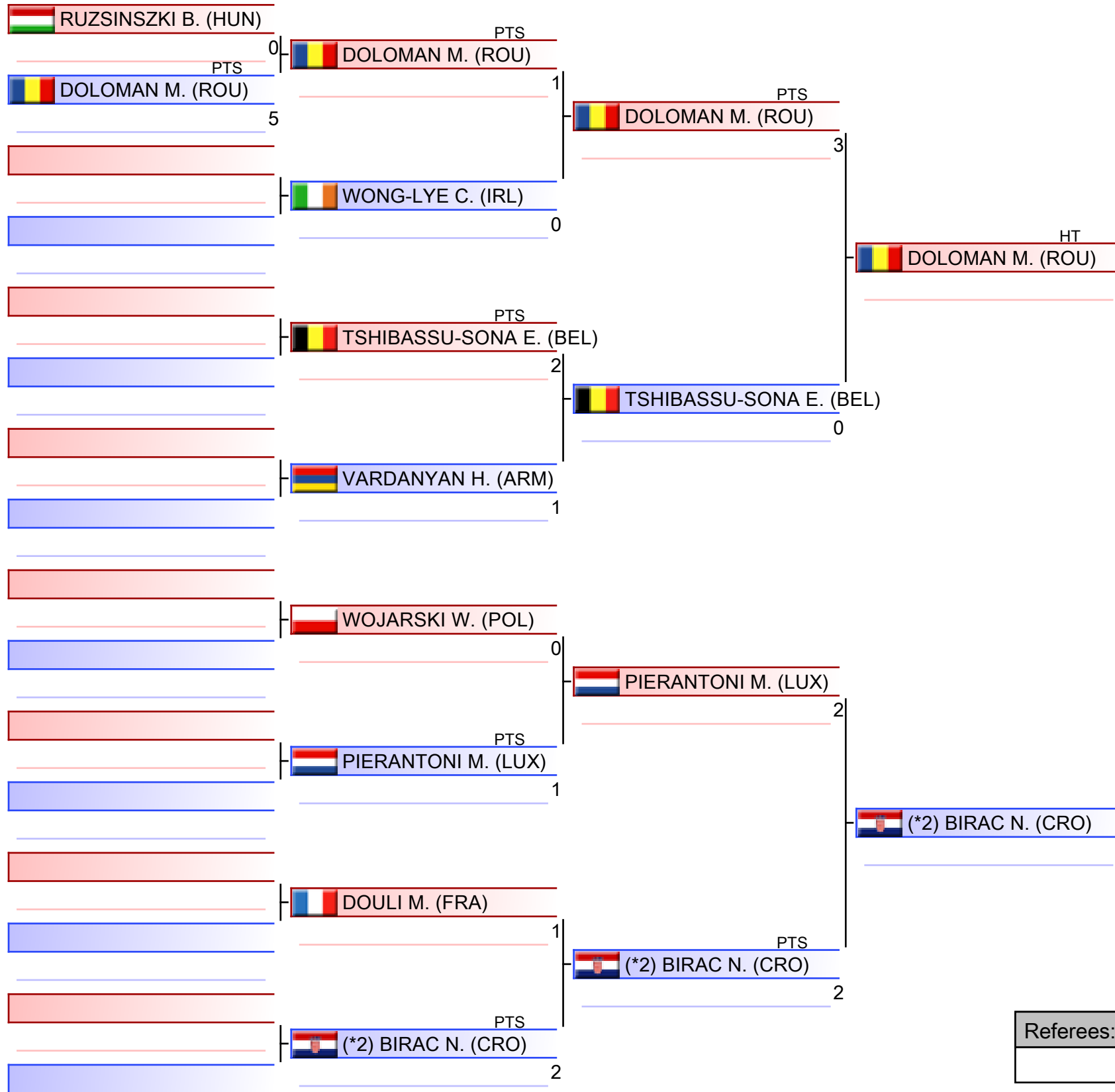

WKF
EUROPE

DOLOMAN M. (ROU)

1. TURCANIK RICHARD (SVK)
2. DOLOMAN MIHAI CRISTIAN (ROU)
3. ARIFAJ ANES (MNE)
3. MAGOMEDALIEV ABDULKADIR (WKF-1)
5. TSANEV NIKOLAY (BUL)
5. BIRAC NIKOLA (CRO)
7. PASHOV DJEM (MKD)
7. RUZSINSZKI BALAZS (HUN)

*Seeded

Referees:			

Junior Kumite Male -76 kg

EKF Junior, Cadet & U21 Championships 2026 - Limassol, Spyros Kyprianou Athletic Center, Limassol, CYP

2026-02-07

Tatami
4 11:30

Pool
3/4

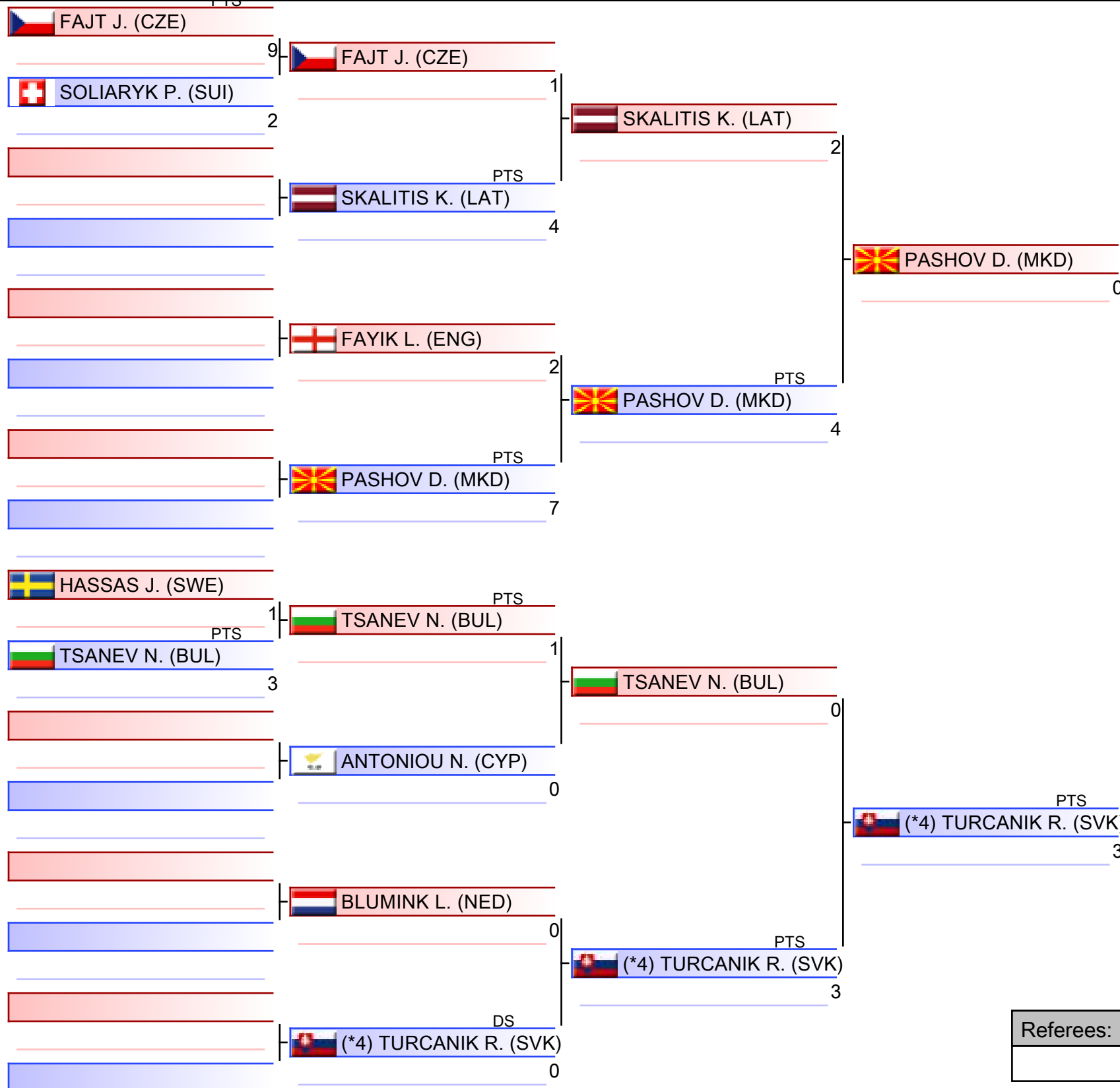

(*4) TURCANIK R. (SVK)

1. TURCANIK RICHARD (SVK)
2. DOLOMAN MIHAI CRISTIAN (ROU)
3. ARIFAJ ANES (MNE)
3. MAGOMEDALIEV ABDULKADIR (WKF-1)
5. TSANEV NIKOLAY (BUL)
5. BIRAC NIKOLA (CRO)
7. PASHOV DJEM (MKD)
7. RUZSINSZKI BALAZS (HUN)

*Seeded

Referees:			

Junior Kumite Male -76 kg

EKF Junior, Cadet & U21 Championships 2026 - Limassol, Spyros Kyprianou Athletic Center, Limassol, CYP

2026-02-07

Tatami
4 12:20

Pool
4/4

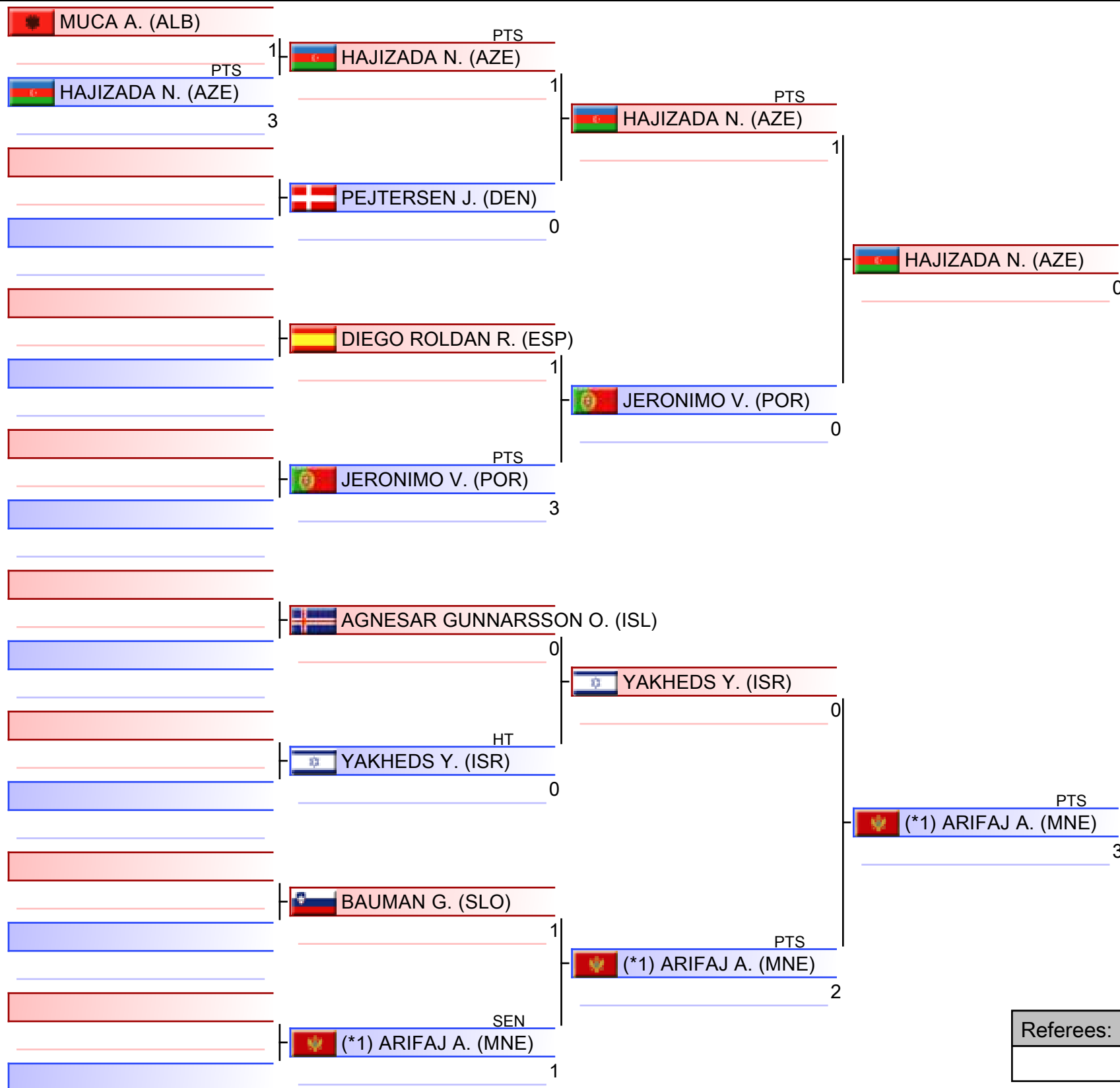

(*1) ARIFAJ A. (MNE)

1. TURCANIK RICHARD (SVK)
2. DOLOMAN MIHAI CRISTIAN (ROU)
3. ARIFAJ ANES (MNE)
3. MAGOMEDALIEV ABDULKADIR (WKF-1)
5. TSANEV NIKOLAY (BUL)
5. BIRAC NIKOLA (CRO)
7. PASHOV DJEM (MKD)
7. RUZSINSZKI BALAZS (HUN)

*Seeded

Referees:			

Pool winner-Junior Kumite Male -76 kg

EKF Junior, Cadet & U21 Championships 2026 - Limassol, Spyros Kyprianou Athletic Center, Limsassol, CYP

2026-02-07

Tatami
3 13:10

Pool
1/1



WKF
EUROPE

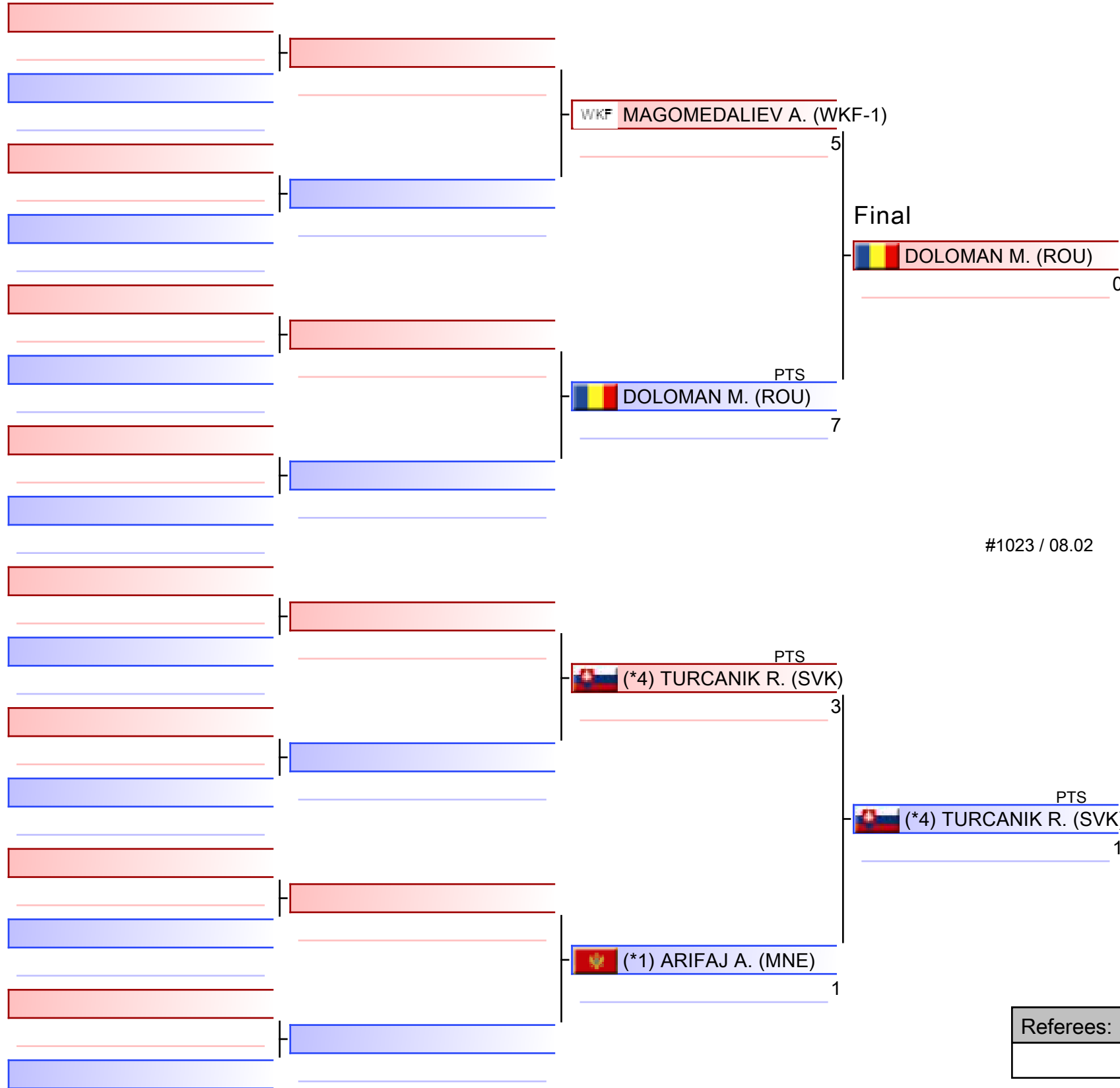

(*4) TURCANIK R. (SVK)

1. TURCANIK RICHARD (SVK)
2. DOLOMAN MIHAI CRISTIAN (ROU)
3. ARIFAJ ANES (MNE)
3. MAGOMEDALIEV ABDULKADIR (WKF-1)
5. TSANEV NIKOLAY (BUL)
5. BIRAC NIKOLA (CRO)
7. PASHOV DJEM (MKD)
7. RUZSINSZKI BALAZS (HUN)

*Seeded

Referees:			

Junior Kumite Male -76 kg

EKF Junior, Cadet & U21 Championships 2026 - Limassol

2026-02-07

Tatami
8 17:35

Pool
1,2,3,4

(c)sportdata GmbH & Co KG 2000-2026 (2026-02-08 17:46) v 11.0.0 build 2 (2025-01-21 11:49 CET) License: SDIL TWG2025 (expire 2026-09-30)

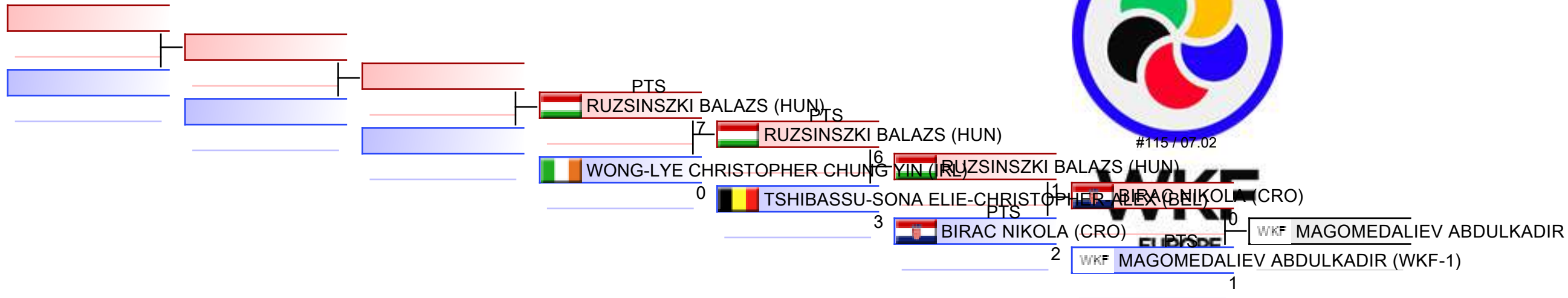

REPECHAGE: (1,2,3,4)

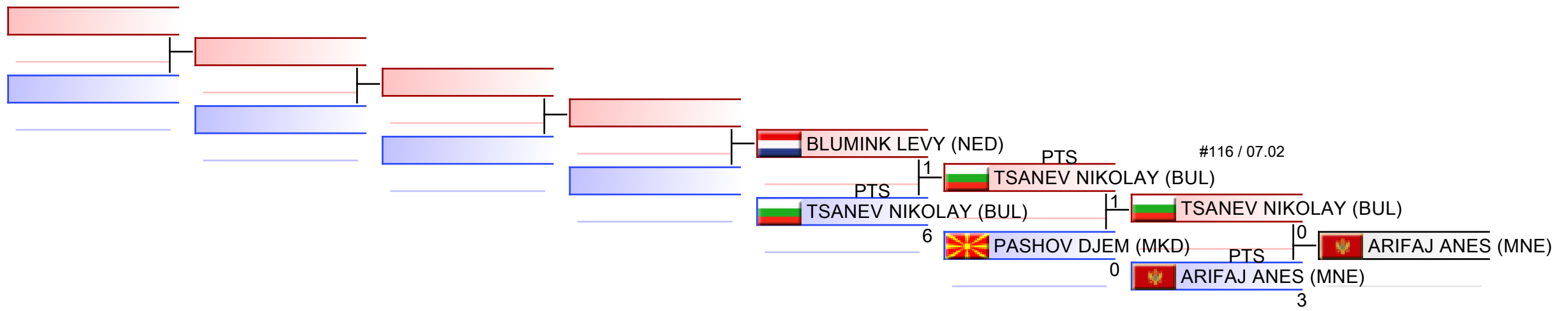

Referees:							
-----------	--	--	--	--	--	--	--



EKF Junior, Cadet & U21 Championships
2026 - Limassol - 2026-02-06



Official Results

Junior Kumite Male -76 kg			
1	TURCANIK RICHARD		SVK - SLOVAKIA
2	DOLOMAN MIHAI CRISTIAN		ROU - ROMANIA
3	ARIFAJ ANES		MNE - MONTENEGRO
3	MAGOMEDALIEV ABDULKADIR		WKF-1 - WKF-1
5	TSANEV NIKOLAY		BUL - BULGARIA
5	BIRAC NIKOLA		CRO - CROATIA
7	PASHOV DJEM		MKD - NORTH MACEDONIA
7	RUZSINSZKI BALAZS		HUN - HUNGARY
9	BLUMINK LEVY		NED - NETHERLANDS
9	TSHIBASSU-SONA ELIE-CHRISTOPHER-ALEX		BEL - BELGIUM
11	WONG-LYE CHRISTOPHER CHUNG YIN		IRL - IRELAND

JUNIOR KUMITE MALE 76+ KG



EKF Junior, Cadet & U21 Championships 2026 - Lim..



ENTRIES BY WEIGHT CATEGORY

Junior Kumite Male 76+ kg

As of 8 FEB 2026

Code	ID	Gender	Name	Seeding
ALB	ALB02277	M	DURBAKU AMAR	
ARM	ARM003267	M	GASPARYAN EMANUEL	
AZE	AZE02700	M	GAYIBOV JAHANGIR	
BIH	BIH03206	M	SPAHIC BELMIN	
BUL	BUL2216	M	SOTIROV BOJIDAR	
CRO	CRO03489	M	SOLTIC ERVIN	3
CYP	CYP02842	M	THEMISTOKLEOUS CHARALAMPOS	
CZE	CZE02750	M	PALAN MARTIN	
DEN	DEN003000	M	PEJTERSEN EMIL MARKMANN	
ENG	ENG003607	M	LOKAJ DRIN	
ESP	ESP03481	M	STOIA ONU PAUL GABRIEL	
EST	EST02637	M	FOMIN KIRILL	
FRA	FRA004446	M	AKGUN MUHAMMED ALI	
GEO	GEO02810	M	KONJARIA NIKO	
GER	GER004127	M	KURZ PHIL	
GRE	GRE02915	M	ARGYRAKIS CHRISTOS	
HUN	HUN003372	M	GOMBKOTO BALINT	
ISR	ISR003241	M	GUTIERREZ ARIEL	
ITA	ITA005601	M	FERRARINI FRANCESCO	1
LAT	LAT003164	M	NIPANS ROBERTS	
MDA	MDA02453	M	CUCUL SAVELII	
MKD	MKD03323	M	NIKOLOVSKI DARIJAN	
MNE	MNE2430	M	VUCINIC VUK	
NED	NED003575	M	DE ROVER LUKE	
POL	POL3965	M	PRZASNYSKI MICHAL	2
POR	POR003495	M	AGUIAR ANDRE	
ROU	ROU03801	M	BARCIU IONUT VALENTIN	
SLO	SLO03039	M	GACIC ALEKSANDER	
SRB	SRB2800	M	VILOTIJEVIC ANDREJ	
SUI	SUI02742	M	BUHURCU JIYAN	
SVK	SVK003251	M	NANO TOMAS	
UKR	UKR003730	M	RUDENKO VLADYSLAV	4
WAL	WAL02302	M	PHILLIPS LOGAN	
WKF-1	WKF-1006809	M	KALMYKOV ILIA	

Junior Kumite Male 76+ kg

EKF Junior, Cadet & U21 Championships 2026 - Limassol, Spyros Kyprianou Athletic Center, Limassol, CYP

2026-02-07

Tatami
3 13:15

Pool
1/4

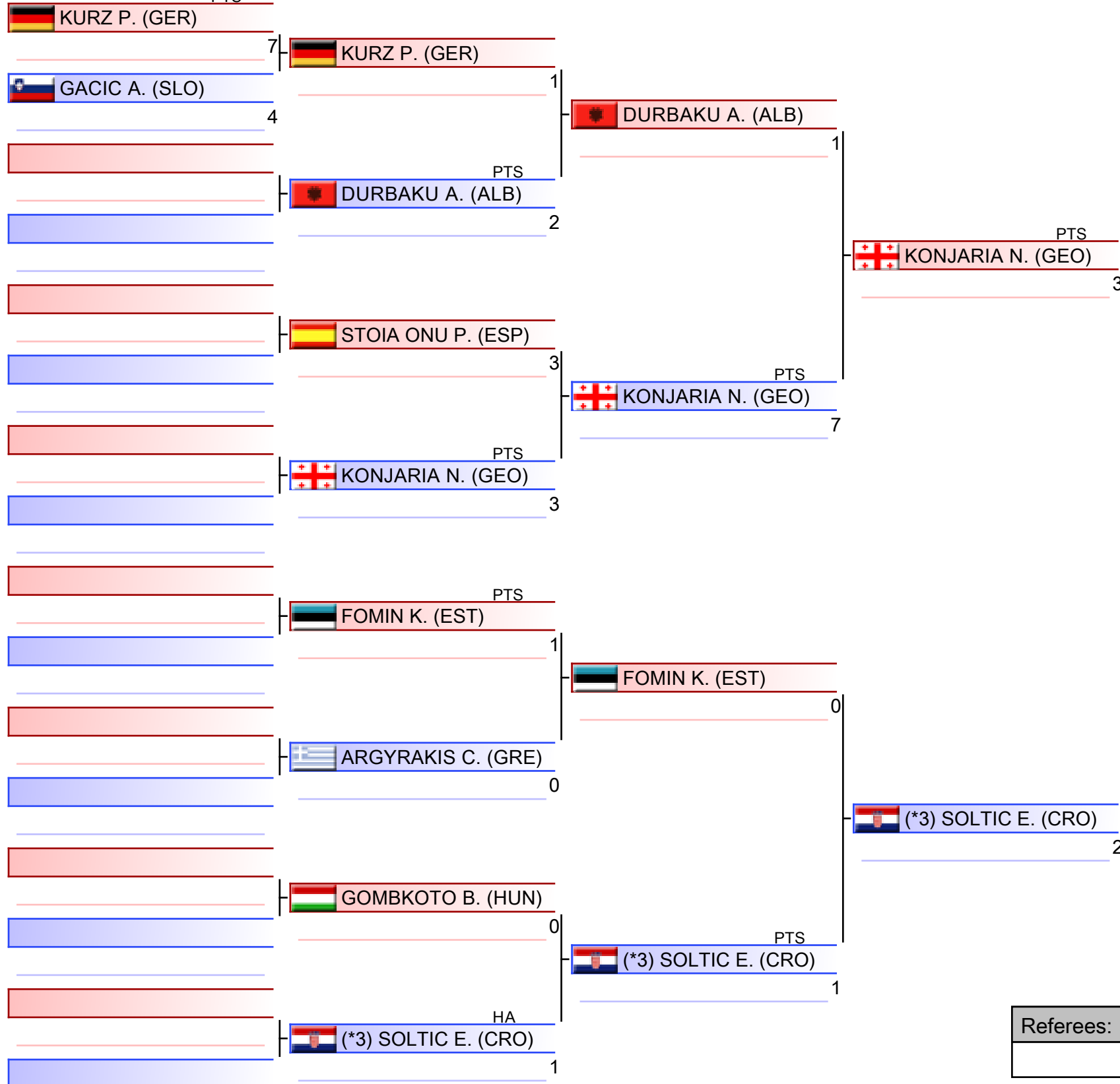

WKF
EUROPE

1. VUCINIC VUK (MNE)
2. RUDENKO VLADYSLAV (UKR)
3. FERRARINI FRANCESCO (ITA)
3. SOTIROV BOJIDAR (BUL)
5. AGUIAR ANDRE (POR)
5. KONJARIA NIKO (GEO)
7. SPAHIC BELMIN (BIH)
7. PRZASNYSKI MICHAL (POL)

*Seeded

Referees:			

Junior Kumite Male 76+ kg

EKF Junior, Cadet & U21 Championships 2026 - Limassol, Spyros Kyprianou Athletic Center, Limassol, CYP

2026-02-07

Tatami
3 14:00

Pool
2/4



WKF
EUROPE

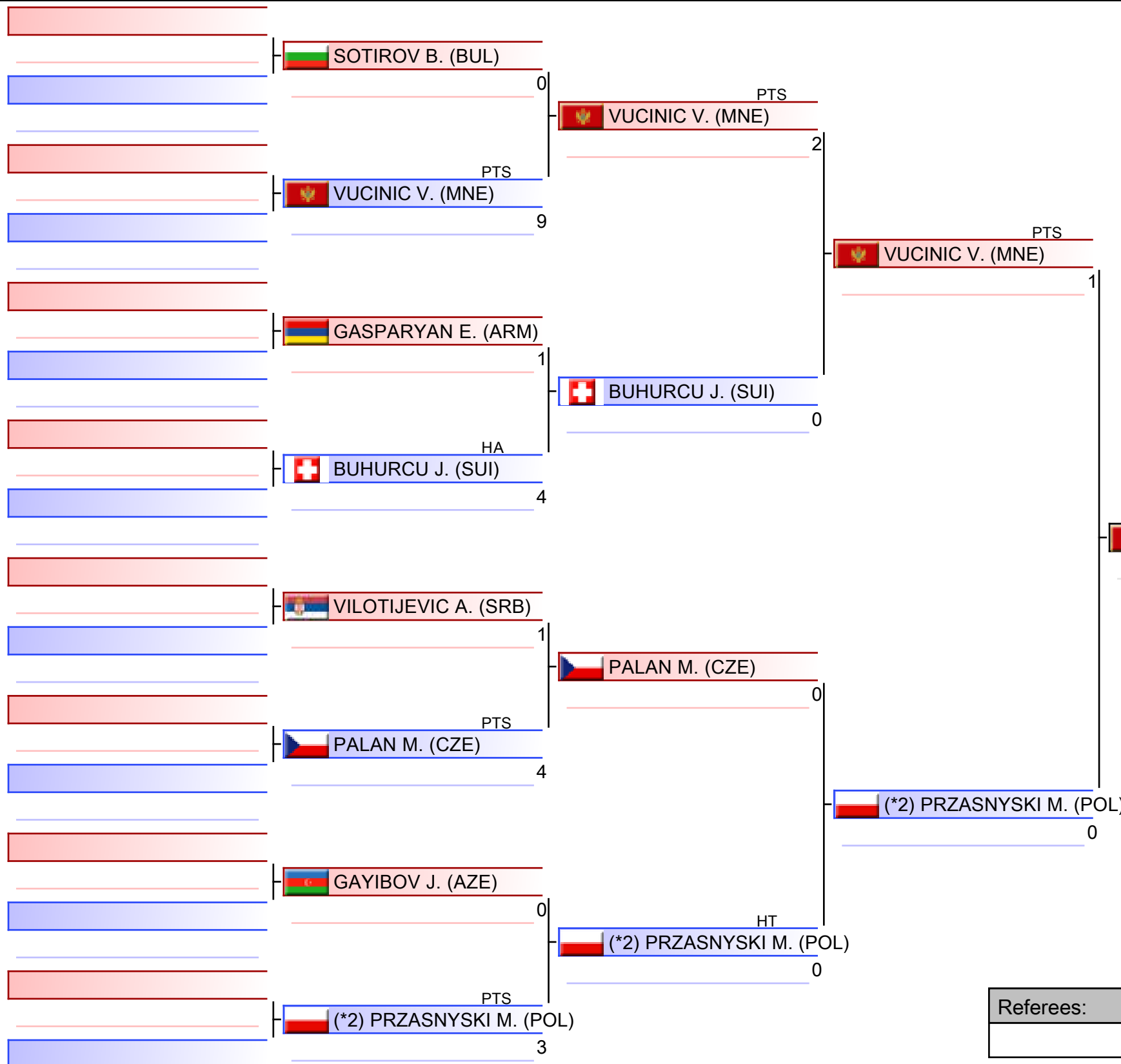

1. VUCINIC VUK (MNE)
2. RUDENKO VLADYSLAV (UKR)
3. FERRARINI FRANCESCO (ITA)
3. SOTIROV BOJIDAR (BUL)
5. AGUIAR ANDRE (POR)
5. KONJARIA NIKO (GEO)
7. SPAHIC BELMIN (BIH)
7. PRZASNYSKI MICHAL (POL)

*Seeded

Referees:			

Junior Kumite Male 76+ kg

EKF Junior, Cadet & U21 Championships 2026 - Limassol, Spyros Kyprianou Athletic Center, Limassol, CYP

2026-02-07

Tatami
4 13:10

Pool
3/4

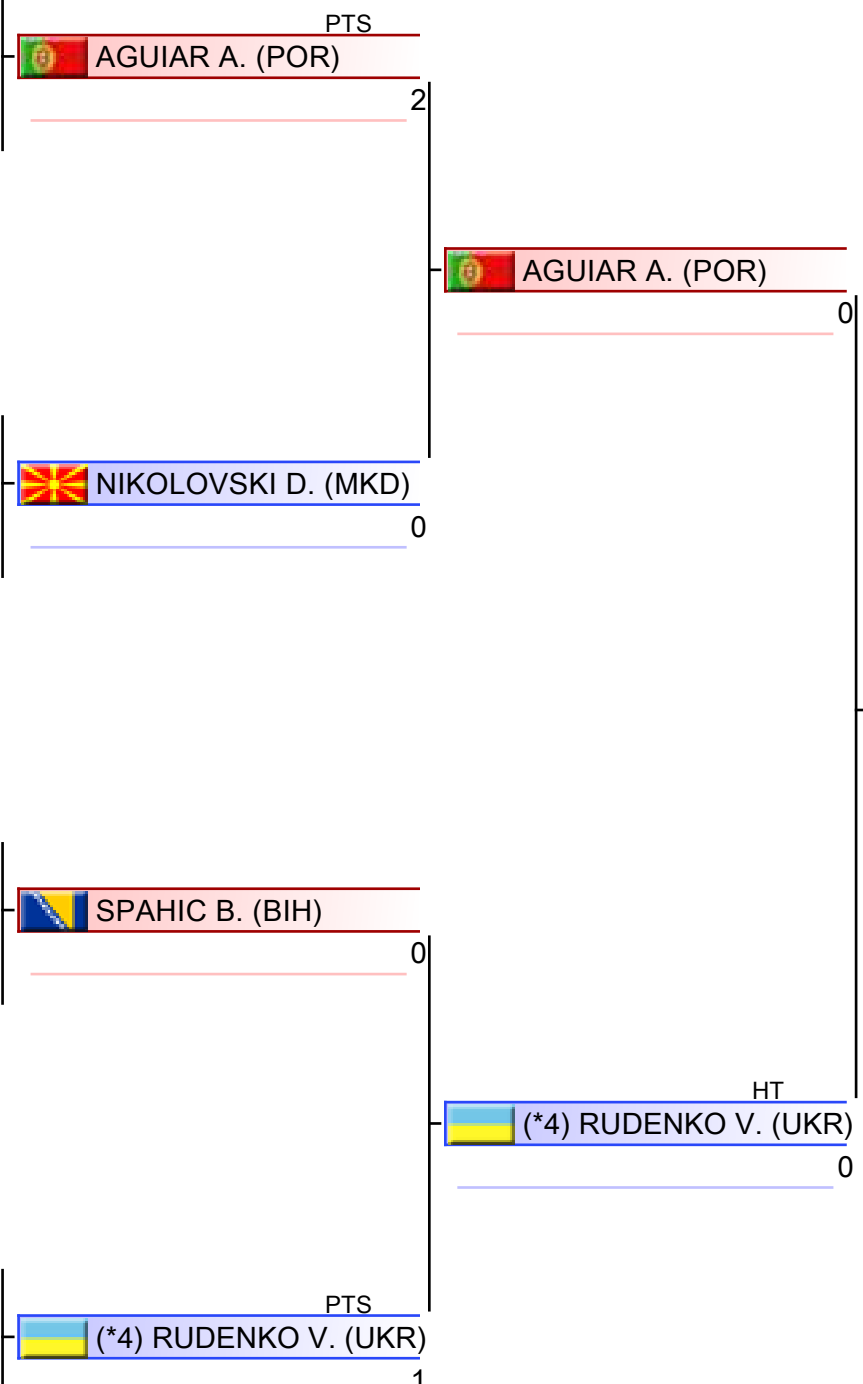
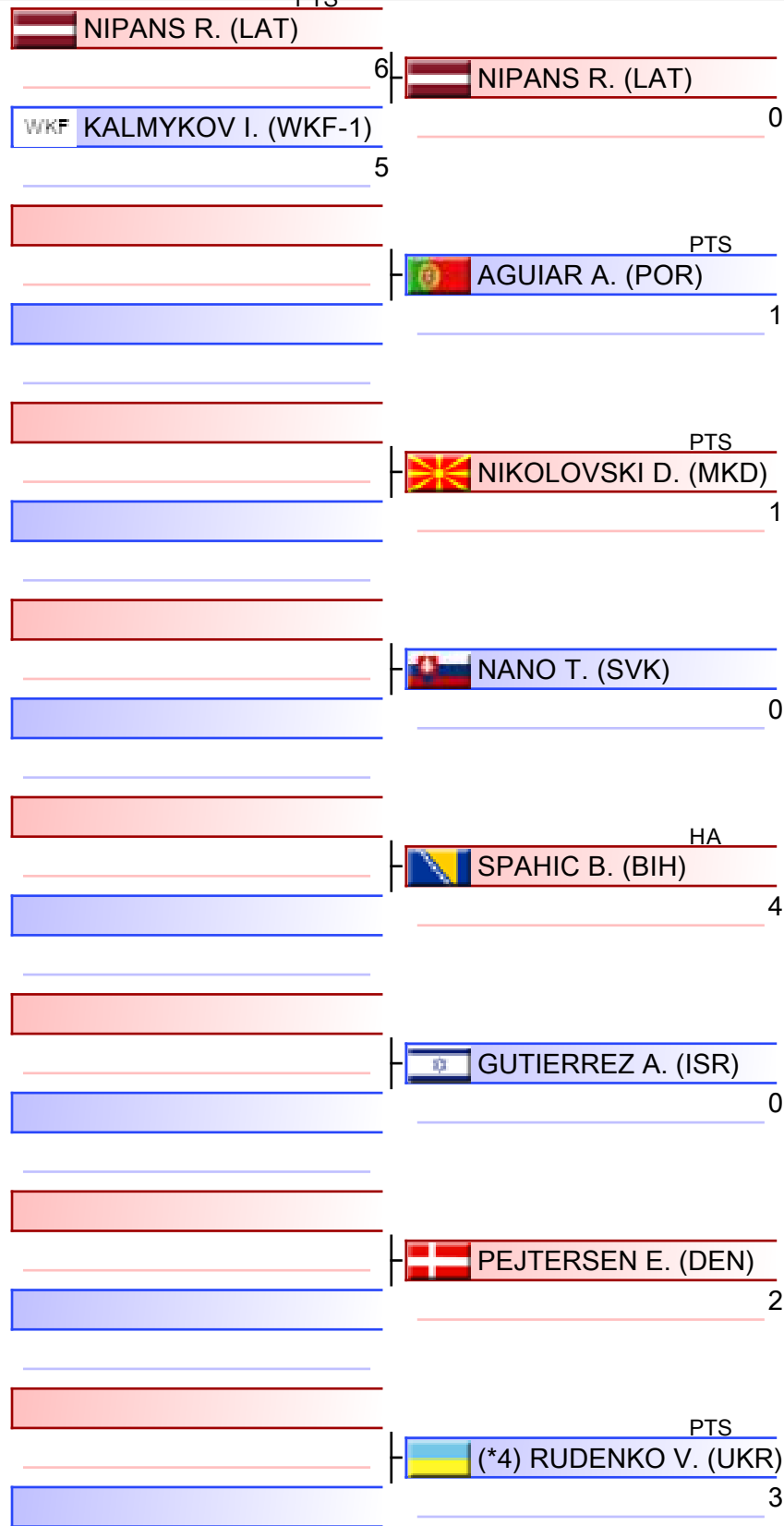

WKF
EUROPE

(*4) RUDENKO V. (UKR)

1. VUCINIC VUK (MNE)
2. RUDENKO VLADYSLAV (UKR)
3. FERRARINI FRANCESCO (ITA)
3. SOTIROV BOJIDAR (BUL)
5. AGUIAR ANDRE (POR)
5. KONJARIA NIKO (GEO)
7. SPAHIC BELMIN (BIH)
7. PRZASNYSKI MICHAL (POL)

*Seeded

Referees:			

Junior Kumite Male 76+ kg

EKF Junior, Cadet & U21 Championships 2026 - Limassol, Spyros Kyprianou Athletic Center, Limassol, CYP

2026-02-07

Tatami
4 13:55

Pool
4/4

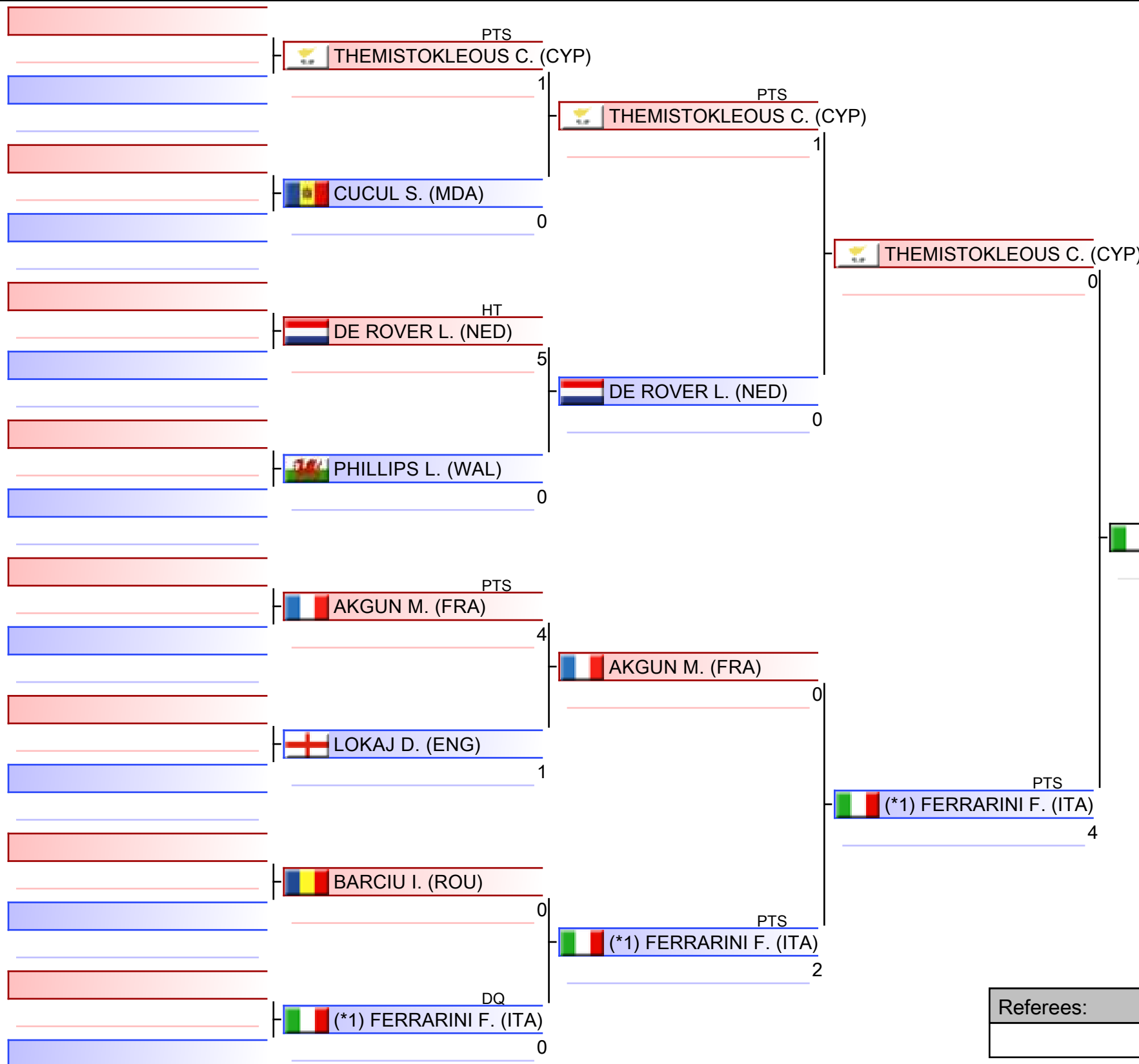

(*1) FERRARINI F. (ITA)

1. VUCINIC VUK (MNE)
2. RUDENKO VLADYSLAV (UKR)
3. FERRARINI FRANCESCO (ITA)
3. SOTIROV BOJIDAR (BUL)
5. AGUIAR ANDRE (POR)
5. KONJARIA NIKO (GEO)
7. SPAHIC BELMIN (BIH)
7. PRZASNYSKI MICHAL (POL)

*Seeded

Referees:			

Pool winner-Junior Kumite Male 76+ kg

EKF Junior, Cadet & U21 Championships 2026 - Limassol, Spyros Kyprianou Athletic Center, Limsassol, CYP

2026-02-07

Tatami
3 14:40

Pool
1/1



WKF
EUROPE

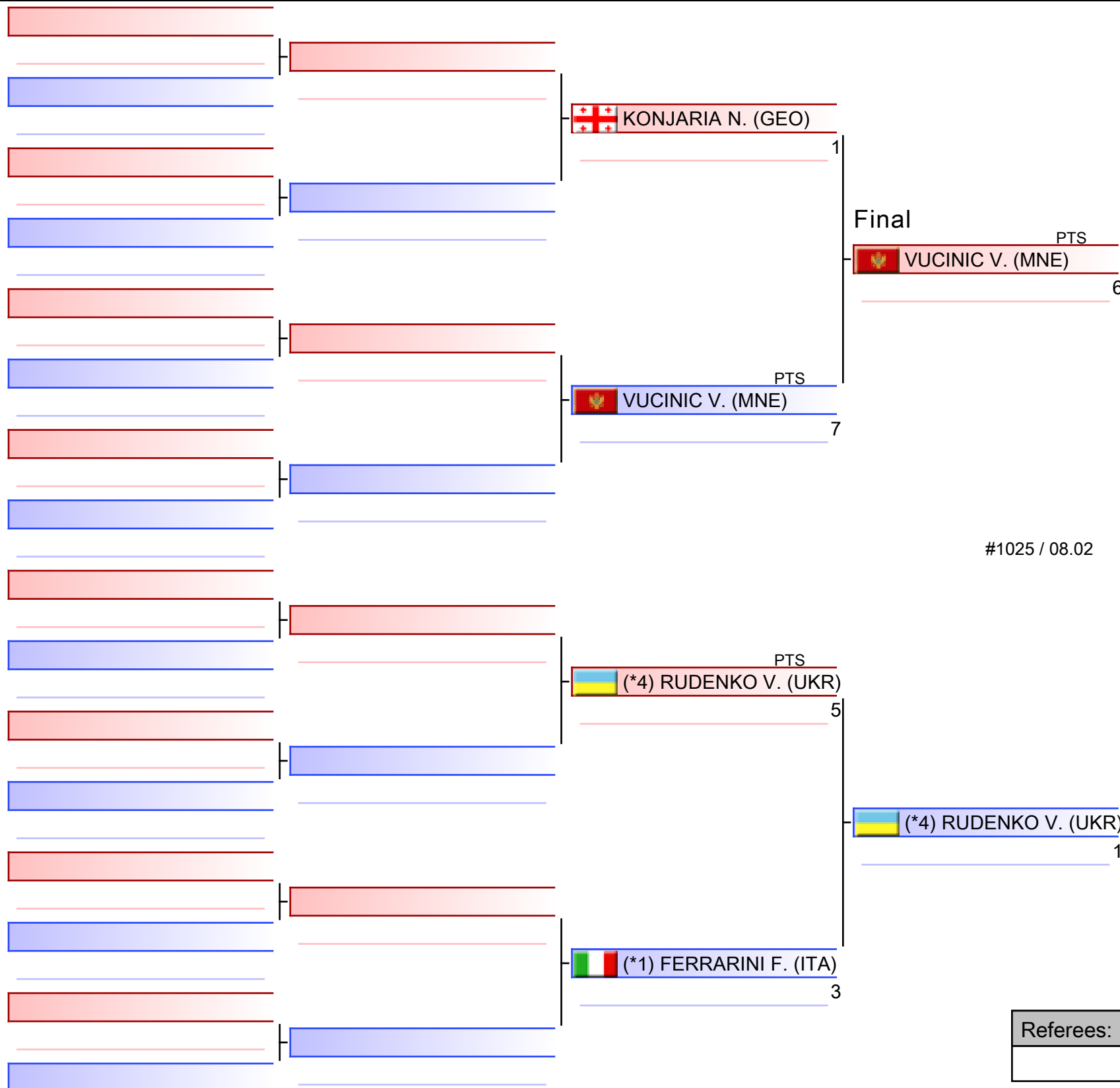

1. VUCINIC VUK (MNE)
2. RUDENKO VLADYSLAV (UKR)
3. FERRARINI FRANCESCO (ITA)
3. SOTIROV BOJIDAR (BUL)
5. AGUIAR ANDRE (POR)
5. KONJARIA NIKO (GEO)
7. SPAHIC BELMIN (BIH)
7. PRZASNYSKI MICHAL (POL)

*Seeded

Referees:			

Junior Kumite Male 76+ kg

EKF Junior, Cadet & U21 Championships 2026 - Limassol

2026-02-07

Tatami

5 17:55

Pool

1,2,3,4

(c)sportdata GmbH & Co KG 2000-2026 (2026-02-08 17:46) v 11.0.0 build 2 (2025-01-21 11:49 CET) License: SDIL TWG2025 (expire 2026-09-30)

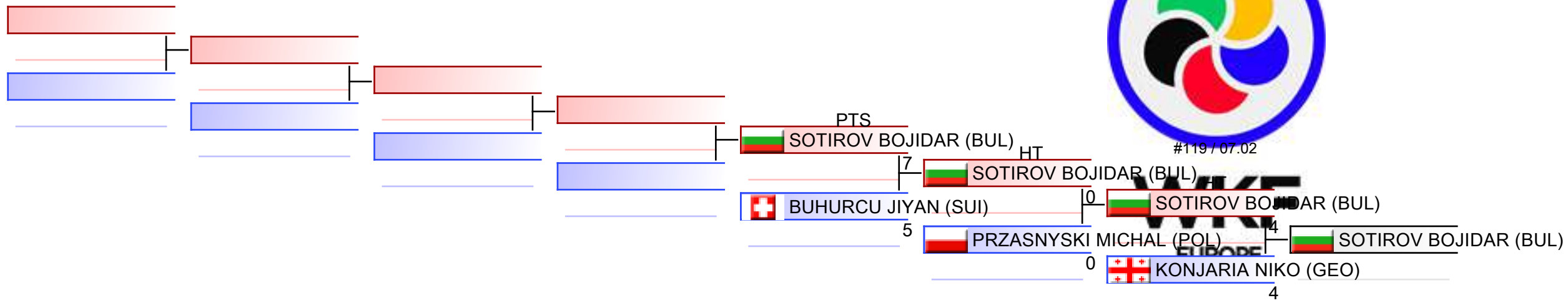

REPECHAGE: (1,2,3,4)

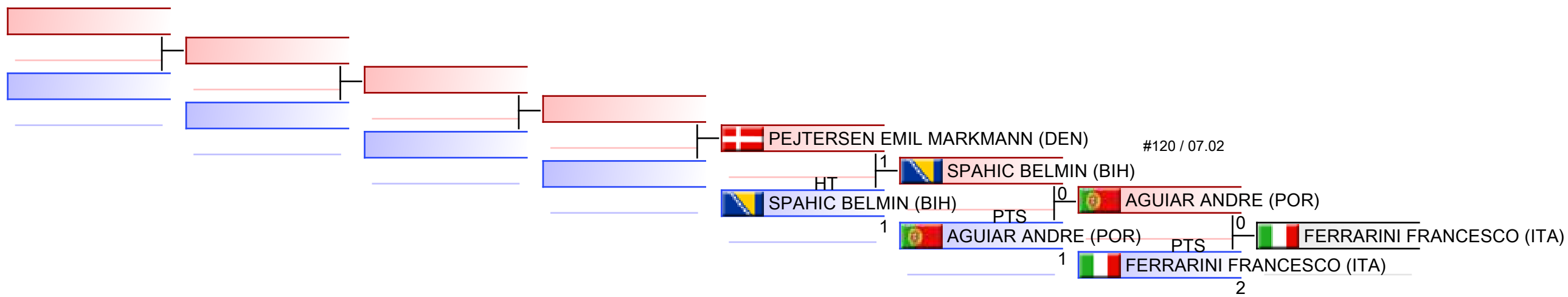

Referees:							
-----------	--	--	--	--	--	--	--



EKF Junior, Cadet & U21 Championships
2026 - Limassol - 2026-02-06



Official Results

Junior Kumite Male 76+ kg			
1	VUCINIC VUK		MNE - MONTENEGRO
2	RUDENKO VLADYSLAV		UKR - UKRAINE
3	FERRARINI FRANCESCO		ITA - ITALY
3	SOTIROV BOJIDAR		BUL - BULGARIA
5	AGUIAR ANDRE		POR - PORTUGAL
5	KONJARIA NIKO		GEO - GEORGIA
7	SPAHIC BELMIN		BIH - BOSNIA AND HERZEGOVINA
7	PRZASNYSKI MICHAL		POL - POLAND
9	PEJTERSEN EMIL MARKMANN		DEN - DENMARK
9	BUHURCU JIYAN		SUI - SWITZERLAND

KATA TEAM CADET AND JUNIOR
FEMALE



EKF Junior, Cadet & U21 Championships 2026 - Lim..



ENTRIES BY WEIGHT CATEGORY

Kata Team Cadet and Junior Female

As of 8 FEB 2026

Code	ID	Gender	Name	Seeding
CRO	CRO04174	F	GRABOVAC ERIKA	
CRO	CRO04167	F	GUDELJ LARA	
CRO	CRO03813	F	JURCEVIC LARA	
CRO	CRO04172	F	RAJKOVIC ENA	
ESP	ESP004279	F	CASTRO LOPEZ ROCIO	2
ESP	ESP003965	F	FOLGUEIRA GONZALEZ UXIA	2
ESP	ESP004148	F	PENA GARCIA CANDELA	2
ESP	ESP004095	F	RODRIGO DIAZ LUCIA	2
FRA	FRA004205	F	CAPET LOUISE	1
FRA	FRA03840	F	VAUCELLE-SPELLE NINON	1
FRA	FRA04094	F	VILANOVA JULIA	1
FRA	FRA004503	F	VORATOVIC ILIANA	1
GER	GER003877	F	BAGHDJIAN DANA	
GER	GER004012	F	GOETHE MARIEL	
GER	GER004216	F	SCHAUDIG LUISA	
GRE	GRE03415	F	BOUGIOUKLAKI SPYRIDOULA	
GRE	GRE03039	F	LAMPADA DANAI	
GRE	GRE03095	F	ZERVOU ELENI	
HUN	HUN03074	F	BACSO KATA	
HUN	HUN03073	F	BENKO SZONJA LOLA	
HUN	HUN003519	F	HUSZTY ZSUZSANNA	
ITA	ITA005920	F	DUBLINO BEATRICE	4
ITA	ITA005927	F	ESPOSITO EMILIA	4
ITA	ITA05406	F	ORSETTI ANNA	4
ITA	ITA005694	F	TAGLIABUE SILVIA	4
MKD	MKD03326	F	ILIJOSKA JOVANA	
MKD	MKD02996	F	JORDANOSKI KATERINA	
MKD	MKD02995	F	JORDANOSKI MARIJA	
MKD	MKD02992	F	MILANOSKA CVETE	
MLT	MLT02238	F	AWAD ATTIA JENNA	
MLT	MLT02241	F	ROADLEY-BATTIN EVIE	
MLT	MLT02201	F	SALIBA FRANCESCA	
POL	POL2942	F	LENART LENA	
POL	POL2940	F	LYSZKIEWICZ LENA	
POL	POL2941	F	MILITOWSKA SARA	
POL	POL2858	F	ZUREK MILENA	
SLO	SLO02831	F	JERSIC ZANA	
SLO	SLO02940	F	KRAMAR LILI	
SLO	SLO02926	F	KREGAR GABRIELA	
SLO	SLO02719	F	MAVSAR TAJDA	
SRB	SRB03779	F	ARSIC TEODORA	
SRB	SRB03480	F	GRUJANIC IRENA	
SRB	SRB03069	F	VALASEK NADJA	
SUI	SUI02740	F	RITZ LILA	
SUI	SUI02739	F	RITZ MAIA	



EKF Junior, Cadet & U21 Championships 2026 - Lim..



ENTRIES BY WEIGHT CATEGORY

Kata Team Cadet and Junior Female

As of 8 FEB 2026

Code	ID	Gender	Name	Seeding
SUI	SUI004380	F	SIGILLO ANASTASIA	
SVK	SVK003449	F	KEMENYIKOVA DOMINIKA	
SVK	SVK003244	F	KISSKOVA KAROLINA	
SVK	SVK003450	F	KLEMPOVA LAURA	
WKF-1	AIN-1006342	F	AVANESOVA VERONIKA	
WKF-1	WKF-1006803	F	KHOSROEVA ALINA	
WKF-1	WKF-1006800	F	NEMCHENKO ANGELINA	
WKF-1	WKF-1006795	F	PANTILEEVA ELIZAVETA	

Kata Team Cadet and Junior Female

EKF Junior, Cadet & U21 Championships 2026 - Limassol, Spyros Kyprianou Athletic Center, Limsassol, CYP

2026-02-07

Tatami
1 09:00

Pool
1/4

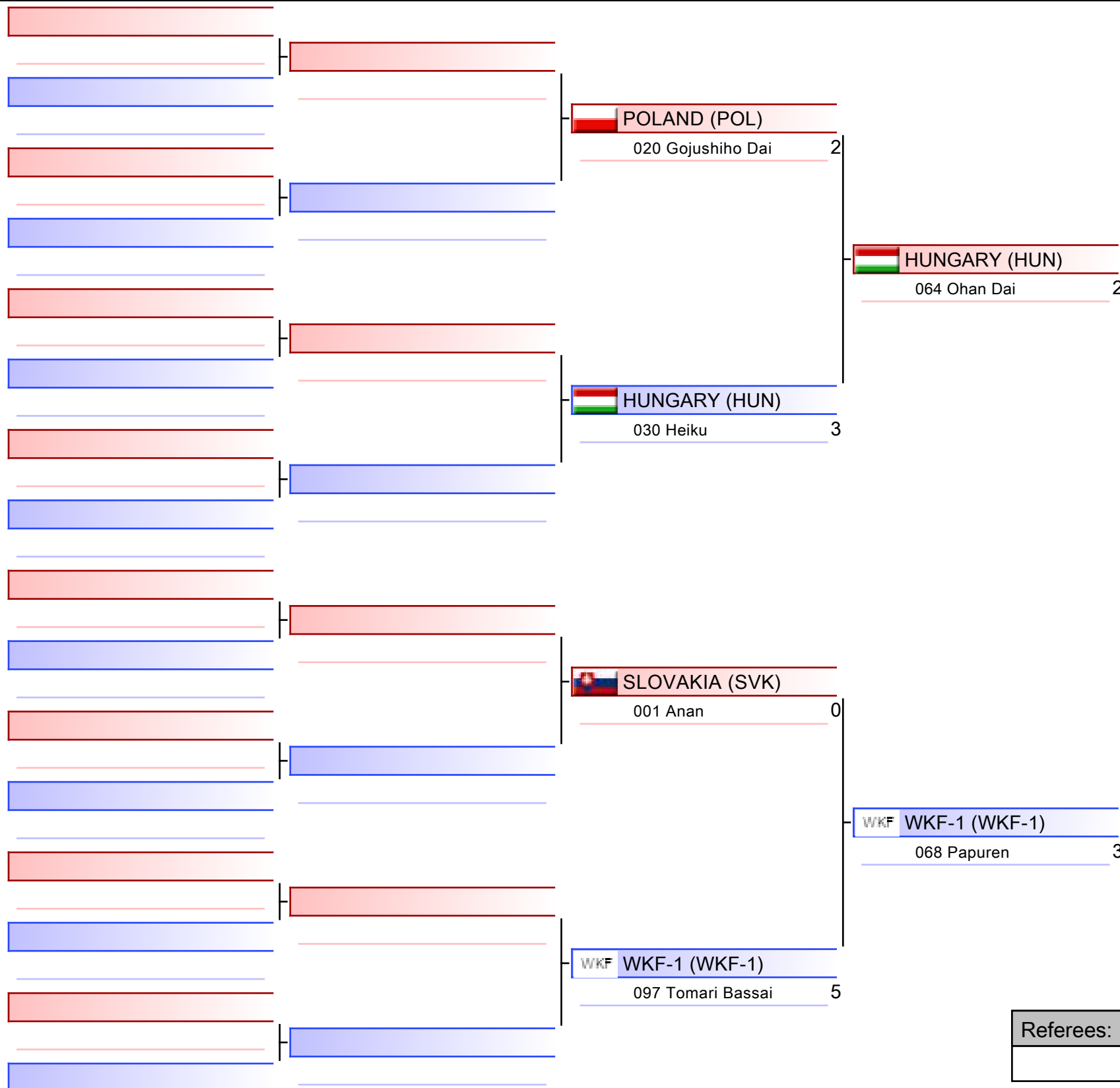

WKF
EUROPE

WKF WKF-1 (WKF-1)

1. FRANCE (FRA)
2. SPAIN (ESP)
3. ITALY (ITA)
3. WKF-1 (WKF-1)
5. GERMANY (GER)
5. SERBIA (SRB)
7. MALTA (MLT)

*Seeded

Referees:			

Kata Team Cadet and Junior Female

EKF Junior, Cadet & U21 Championships 2026 - Limassol, Spyros Kyprianou Athletic Center, Limsassol, CYP

2026-02-07

Tatami
2 09:00

Pool
2/4

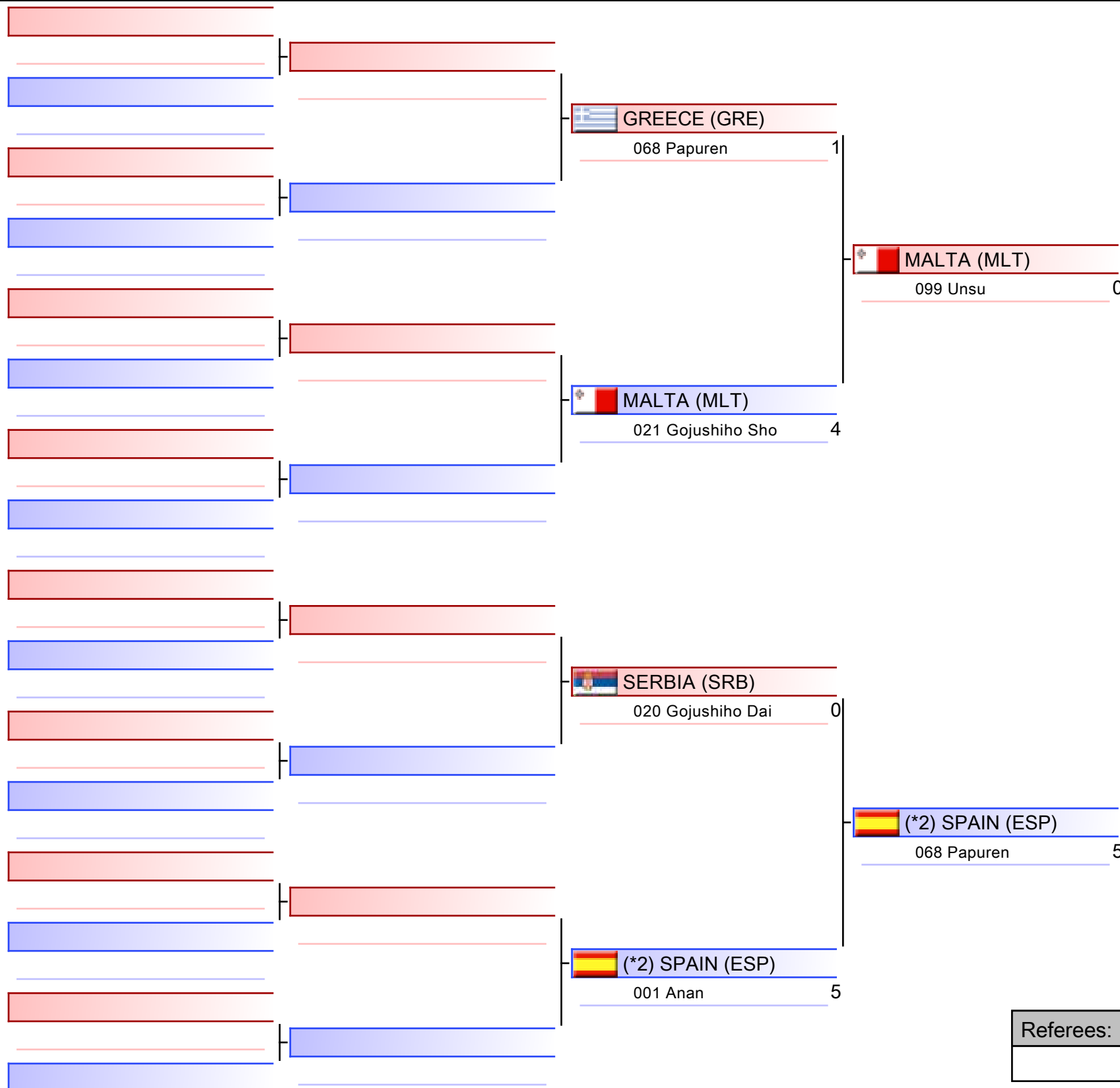

(*2) SPAIN (ESP)

1. FRANCE (FRA)
2. SPAIN (ESP)
3. ITALY (ITA)
3. WKF-1 (WKF-1)
5. GERMANY (GER)
5. SERBIA (SRB)
7. MALTA (MLT)

*Seeded

Referees:			

Kata Team Cadet and Junior Female

EKF Junior, Cadet & U21 Championships 2026 - Limassol, Spyros Kyprianou Athletic Center, Limsassol, CYP

2026-02-07

Tatami
3 09:00

Pool
3/4



WKF
EUROPE

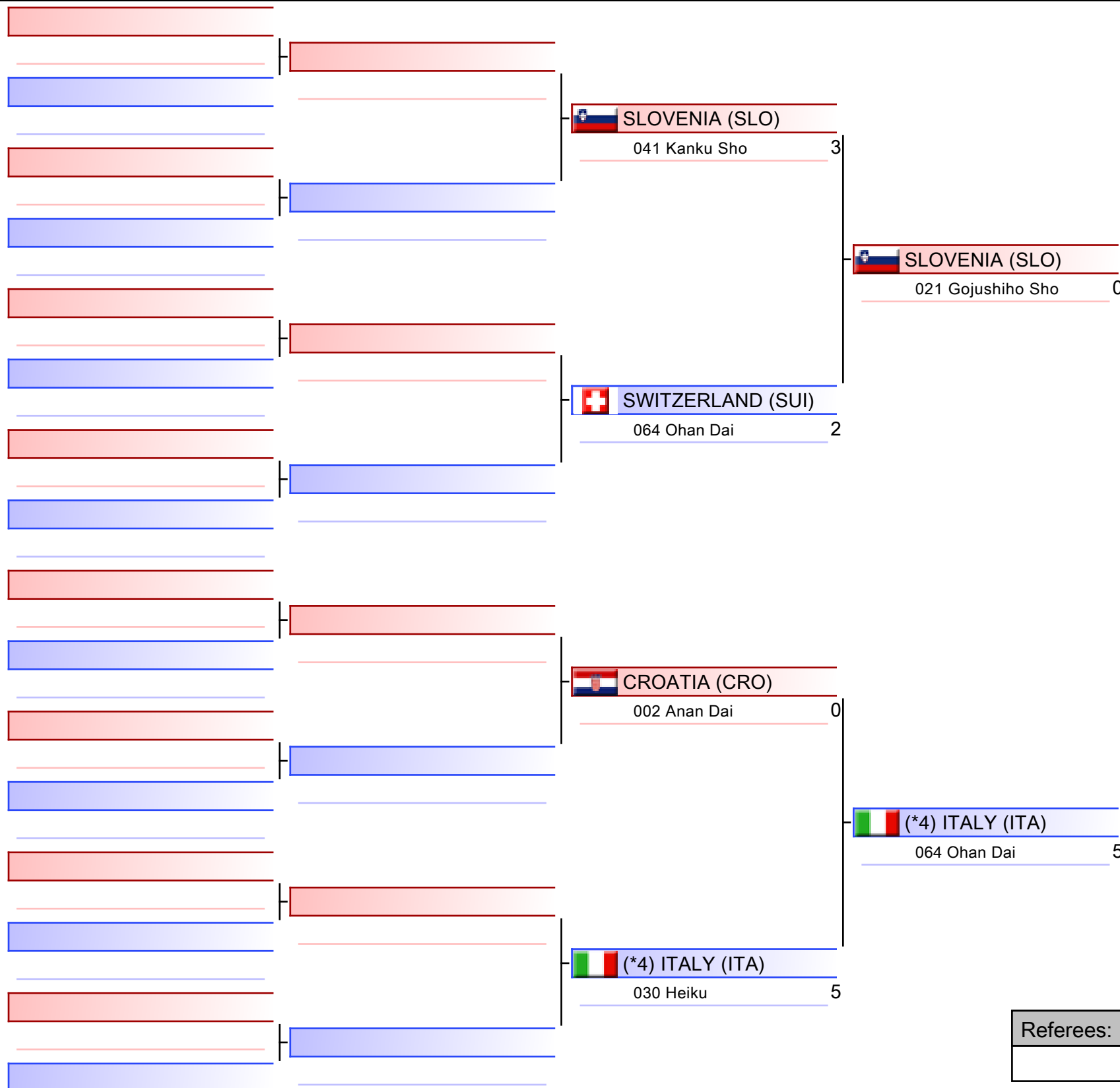

(*4) ITALY (ITA)

1. FRANCE (FRA)
2. SPAIN (ESP)
3. ITALY (ITA)
3. WKF-1 (WKF-1)
5. GERMANY (GER)
5. SERBIA (SRB)
7. MALTA (MLT)

*Seeded

Referees:			

Kata Team Cadet and Junior Female

EKF Junior, Cadet & U21 Championships 2026 - Limassol, Spyros Kyprianou Athletic Center, Limsassol, CYP

2026-02-07

Tatami
4 09:00

Pool
4/4

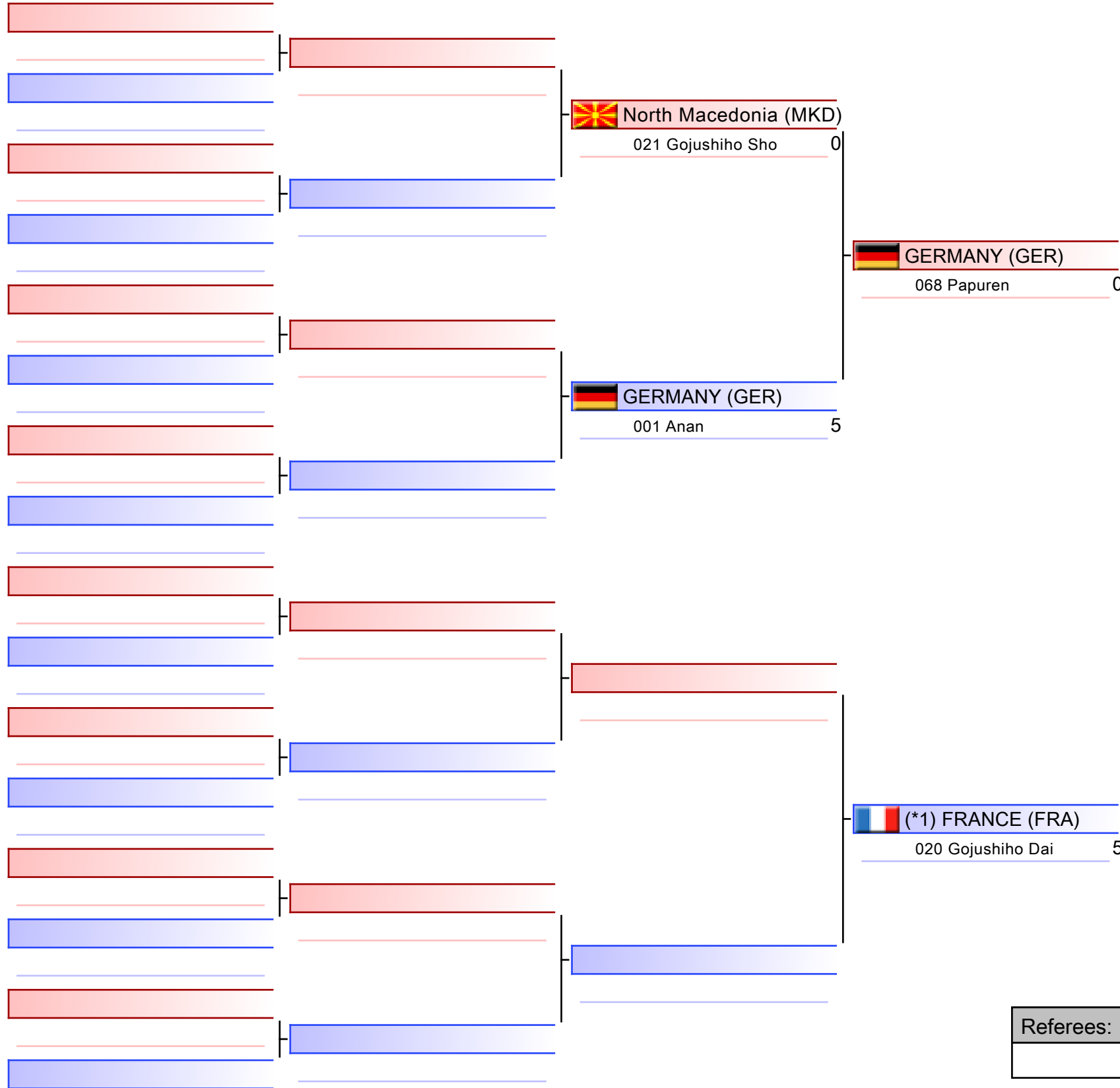

WKF
EUROPE

(*1) FRANCE (FRA)

1. FRANCE (FRA)
2. SPAIN (ESP)
3. ITALY (ITA)
3. WKF-1 (WKF-1)
5. GERMANY (GER)
5. SERBIA (SRB)
7. MALTA (MLT)

*Seeded

Referees:			

Pool winner-Kata Team Cadet and Junior Female

EKF Junior, Cadet & U21 Championships 2026 - Limassol, Spyros Kyprianou Athletic Center, Limsassol, CYP

2026-02-07

Tatami
1 09:25

Pool
1/1

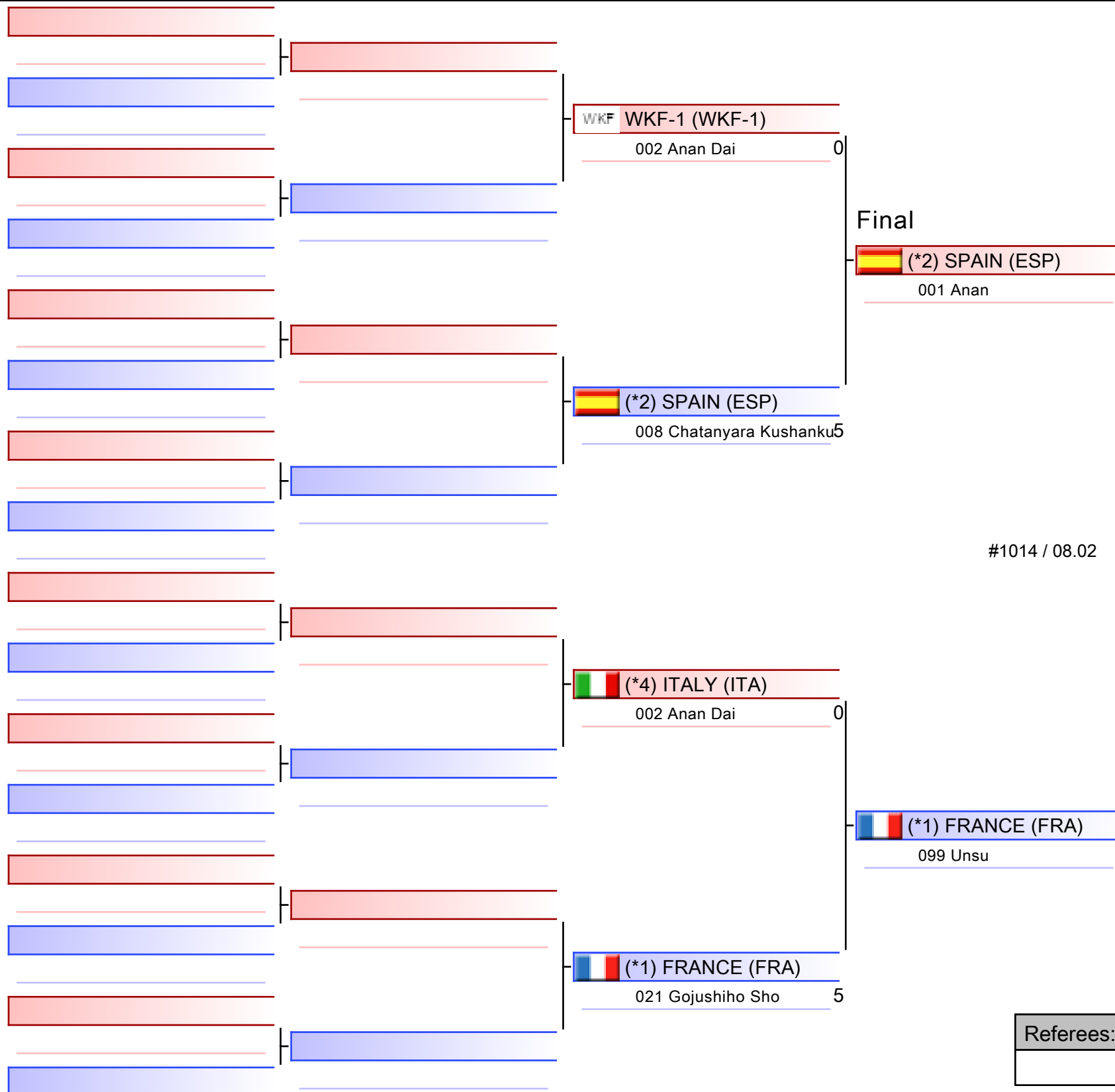

WKF
EUROPE

#1014 / 08.02

1. FRANCE (FRA)
2. SPAIN (ESP)
3. ITALY (ITA)
3. WKF-1 (WKF-1)
5. GERMANY (GER)
5. SERBIA (SRB)
7. MALTA (MLT)

*Seeded

Referees:			

Kata Team Cadet and Junior Female

EKF Junior, Cadet & U21 Championships 2026 - Limassol

2026-02-07

Tatami
2 09:35

Pool
1,2

(c)sportdata GmbH & Co KG 2000-2026 (2026-02-08 17:46) v 11.0.0 build 2 (2025-01-21 11:49 CET) License: SDIL TWG2025 (expire 2026-09-30)

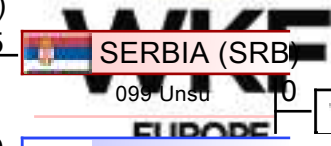
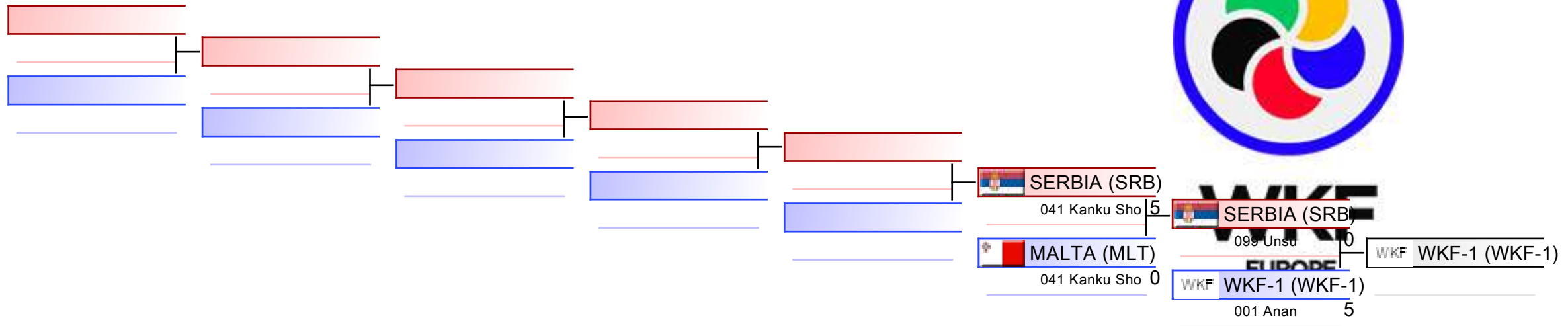

REPECHAGE: (1,2)

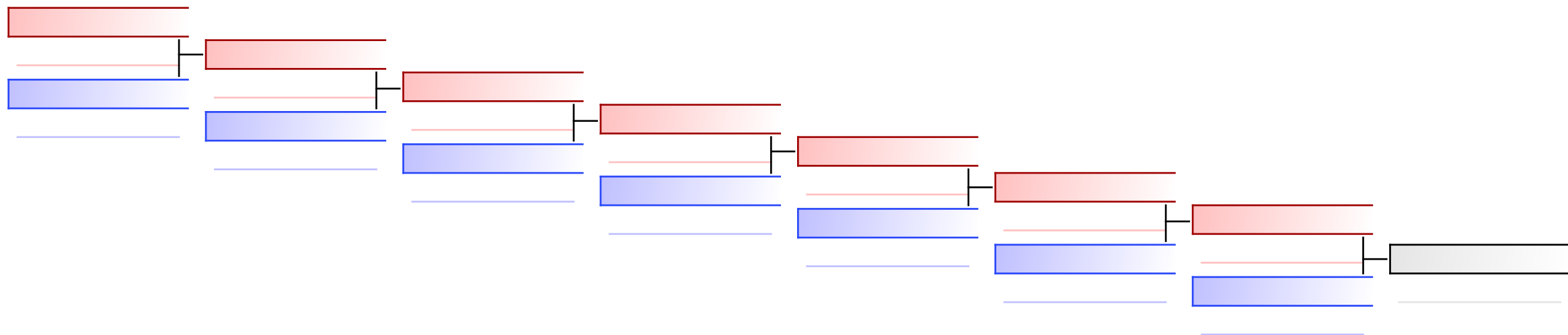

Referees:							
-----------	--	--	--	--	--	--	--

Kata Team Cadet and Junior Female

EKF Junior, Cadet & U21 Championships 2026 - Limassol

2026-02-07

Tatami
4 09:35

Pool
3,4

(c)sportdata GmbH & Co KG 2000-2026 (2026-02-08 17:46) v 11.0.0 build 2 (2025-01-21 11:49 CET) License: SDIL TWG2025 (expire 2026-09-30)

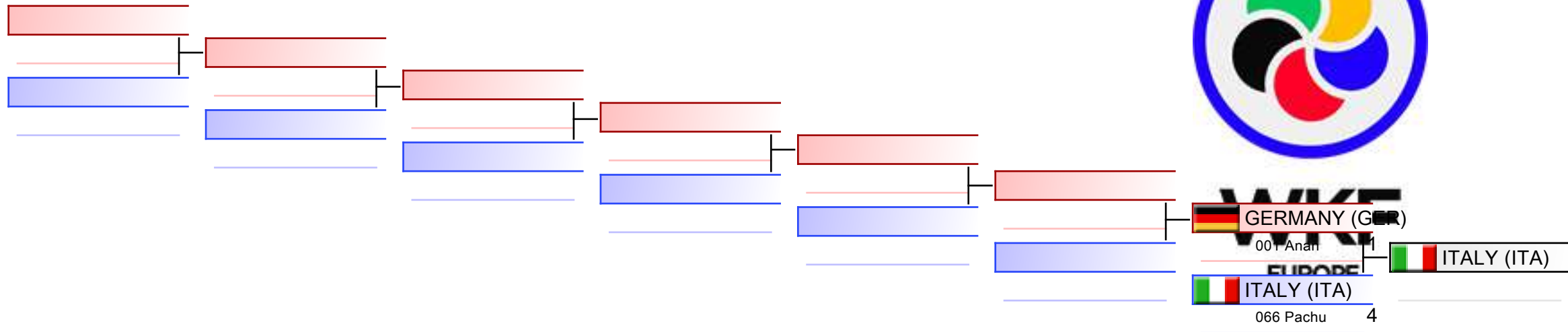

REPECHAGE: (3,4)

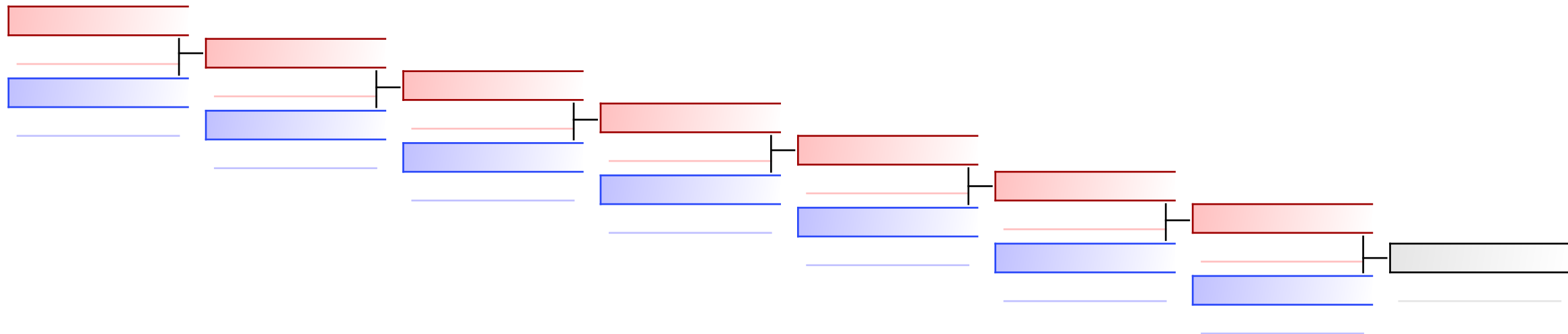

Referees:							
-----------	--	--	--	--	--	--	--



EKF Junior, Cadet & U21 Championships
2026 - Limassol - 2026-02-06



Official Results

Kata Team Cadet and Junior Female			
1	FRANCE - VORATOVIC ILIANA - VAUCELLE-SPELLE NINON - VILANOVA JULIA - CAPET LOUISE		FRA - FRANCE
2	SPAIN - CASTRO LOPEZ ROCIO - FOLGUEIRA GONZALEZ UXIA - PENA GARCIA CANDELA - RODRIGO DIAZ LUCIA		ESP - SPAIN
3	ITALY - DUBLINO BEATRICE - ESPOSITO EMILIA - ORSETTI ANNA - TAGLIABUE SILVIA		ITA - ITALY
3	WKF-1 - PANTILEEVA ELIZAVETA - KHOSROEVA ALINA - NEMCHENKO ANGELINA - AVANESOVA VERONIKA	WKF	WKF-1 - WKF-1
5	GERMANY - BAGHDJIAN DANA - GOETHE MARIEL - SCHAUDIG LUISA		GER - GERMANY
5	SERBIA - ARSIC TEODORA - GRUJANIC IRENA - VALASEK NADJA		SRB - SERBIA
7	MALTA - AWAD ATTIA JENNA - ROADLEY-BATTIN EVIE - SALIBA FRANCESCA		MLT - MALTA

KATA TEAM CADET AND JUNIOR MALE



EKF Junior, Cadet & U21 Championships 2026 - Lim..



ENTRIES BY WEIGHT CATEGORY

Kata Team Cadet and Junior Male

As of 8 FEB 2026

Code	ID	Gender	Name	Seeding
CRO	CRO03418	M	FAIC DAVID	
CRO	CRO03422	M	GRGIC OZREN	
CRO	CRO03388	M	KUKIC IVAN	
CRO	CRO004724	M	SAGI NIKO	
ESP	ESP004315	M	ALVAREZ FERNANDEZ IZAN	
ESP	ESP004414	M	CARMONA DIAZ ENRIQUE	
ESP	ESP004284	M	GONZALEZ SAEZ HUGO	
ESP	ESP004094	M	LEON DE LA PENA JOSE ANGEL	
FRA	FRA004206	M	FRANCES ADRIEN	
FRA	FRA004316	M	HUYET-DUMONG THOMAS	
FRA	FRA004317	M	PILLANT METIS	
FRA	FRA03847	M	RAMDANI MOHAMMED HAROUN	
GER	GER004274	M	ATHANASSIAS APOSTOLOS	
GER	GER004265	M	GSCHWIND VICTOR	
GER	GER03797	M	KUNIYASU HARUAKI	
ISR	ISR02935	M	DE LEVIE YANNAI	
ISR	ISR02937	M	KAUFMAN NETA	
ISR	ISR003246	M	RABAN NIV	
ITA	ITA05407	M	FREDA MATTEO	1
ITA	ITA005917	M	NARDACCIO MATTEO	1
ITA	ITA005919	M	PUTELLI NICOLO	1
ITA	ITA005918	M	ROSIELLO MARCO	1
MNE	MNE03125	M	ALJOSEVIC BENJAMIN	3
MNE	MNE02869	M	BARJAKTAROVIC ALEKSA	3
MNE	MNE03307	M	DJUROVIC ALEKSA	3
POL	POL3959	M	GRZESLO IGOR	
POL	POL06936	M	KOLACKOV LEON	
POL	POL3414	M	MYDLARZ MICHAL	
POL	POL4137	M	NIEDZIELA MICHAL	
POR	SD59627	M	MATEUS VASCO	4
POR	POR03180	M	OLIVEIRA MARTIM	4
POR	POR003477	M	SILVA ANTONIO	4
SRB	SRB03771	M	LONCAREVIC VUK	
SRB	SRB03467	M	MAKSIC VUKASIN	
SRB	SRB03783	M	STOJANOVIC FILIP	
SVK	SVK003446	M	BABEL BRANISLAV	
SVK	SVK003399	M	MACKO PETER	
SVK	SVK003447	M	ORAVCIK JURAJ	
SVK	SVK003448	M	STUSKA SAMUEL	
UKR	UKR003686	M	DAVYDIUK HLIEB	
UKR	UKR003927	M	MAKSYMENKO KIRIL	
UKR	UKR003683	M	TATARYN NAZAR	
WKF-1	WKF-1006802	M	ANUCHIN ALEKSANDR	
WKF-1	WKF-1006801	M	KONDYBAEV NIKITA	
WKF-1	WKF-1006794	M	VLADIMIROV SAVELII	



EKF Junior, Cadet & U21 Championships 2026 - Lim..

ENTRIES BY WEIGHT CATEGORY



Kata Team Cadet and Junior Male

As of 8 FEB 2026

Code	ID	Gender	Name	Seeding
WKF-1	WKF-1006804	M	ZHIRNOV NIKITA	

Kata Team Cadet and Junior Male

EKF Junior, Cadet & U21 Championships 2026 - Limassol, Spyros Kyprianou Athletic Center, Limsassol, CYP

2026-02-07

Tatami
5 09:00

Pool
1/2

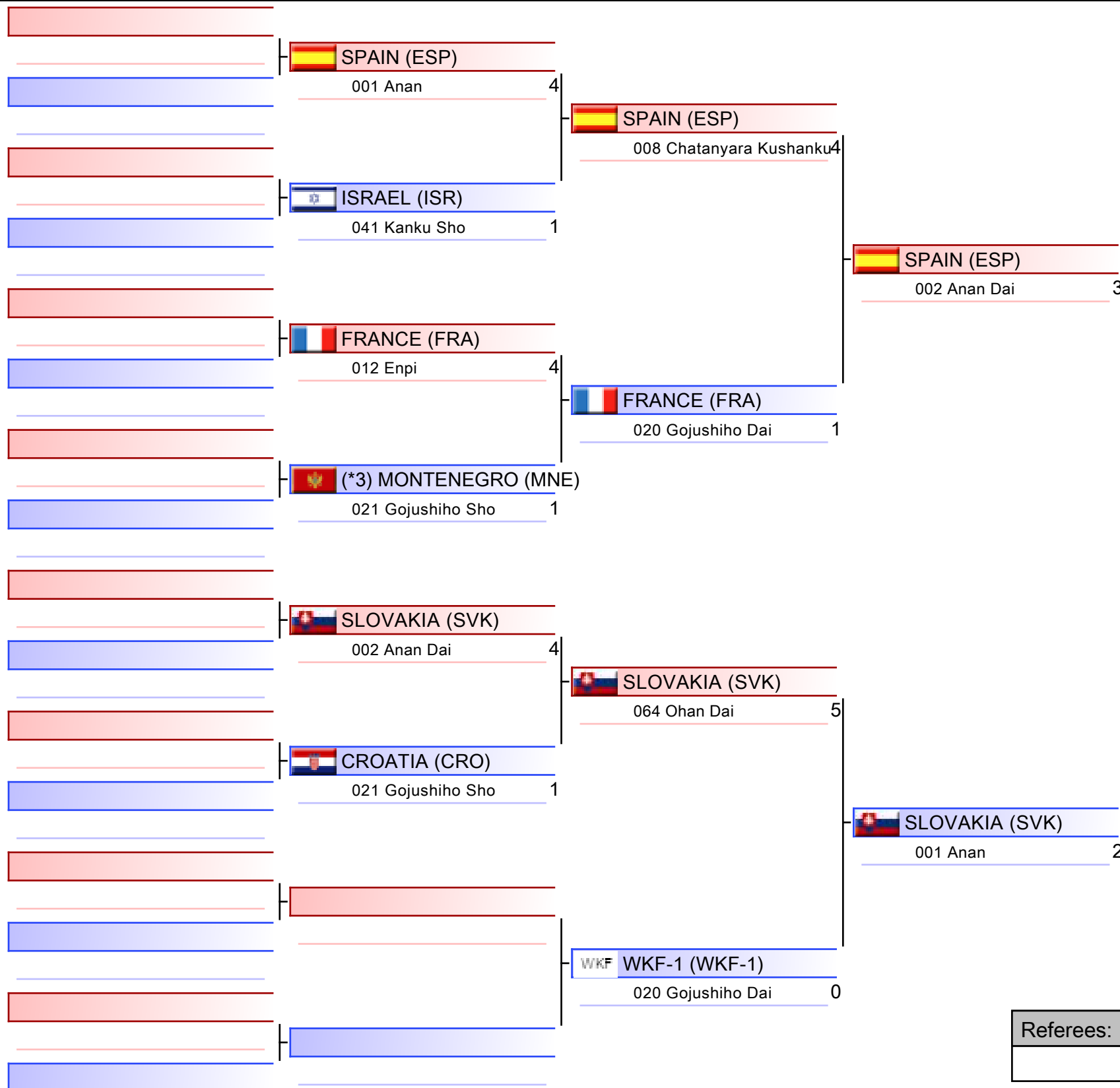

WKF

EUROPE

SPAIN (ESP)

1. ITALY (ITA)
2. SPAIN (ESP)
3. GERMANY (GER)
3. SLOVAKIA (SVK)
5. POLAND (POL)
5. FRANCE (FRA)
7. ISRAEL (ISR)

*Seeded

Referees:			

Kata Team Cadet and Junior Male

EKF Junior, Cadet & U21 Championships 2026 - Limassol, Spyros Kyprianou Athletic Center, Limassol, CYP

2026-02-07

Tatami
6 09:00

Pool
2/2

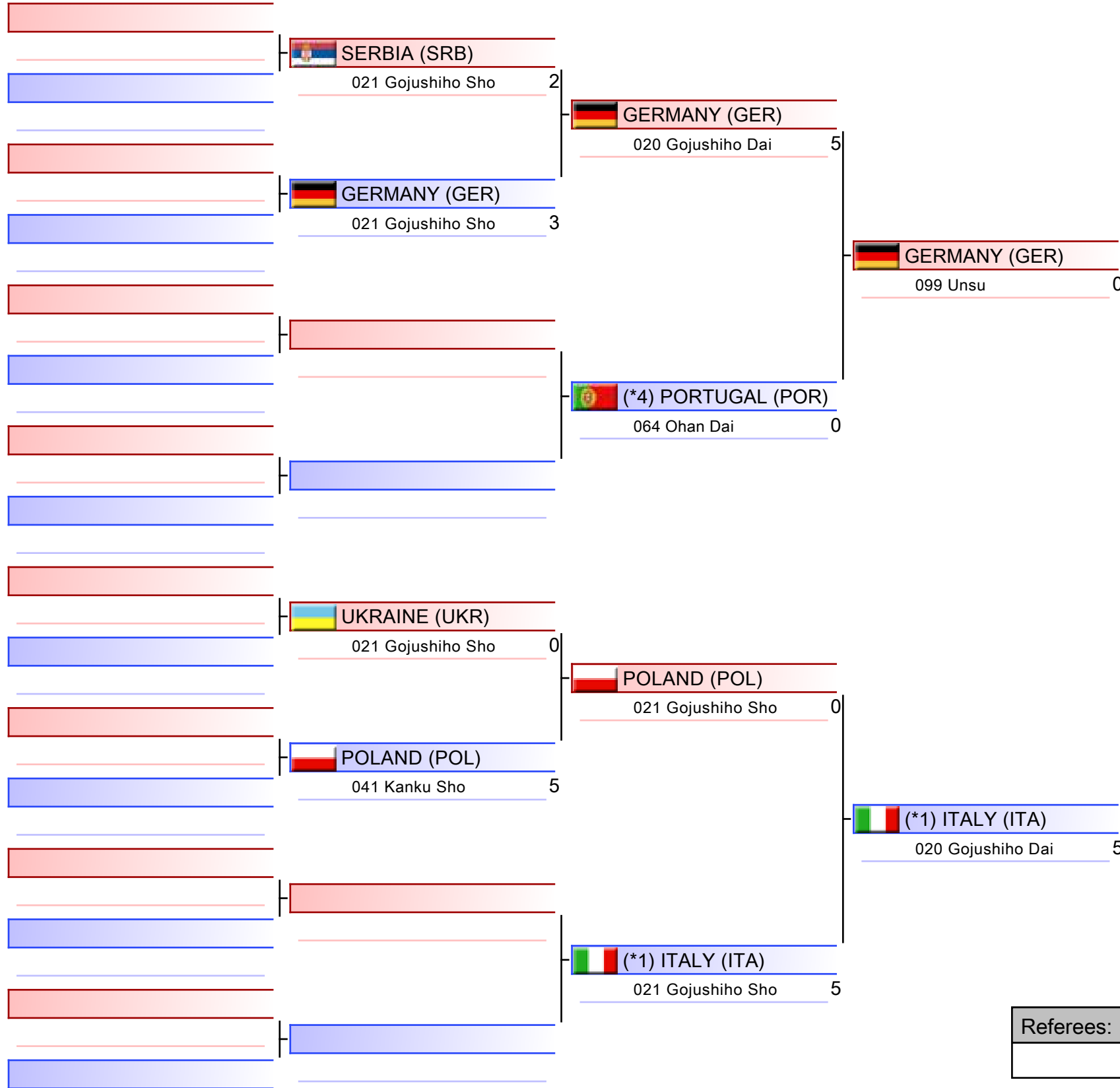

WKF
EUROPE

(*1) ITALY (ITA)

1. ITALY (ITA)
2. SPAIN (ESP)
3. GERMANY (GER)
3. SLOVAKIA (SVK)
5. POLAND (POL)
5. FRANCE (FRA)
7. ISRAEL (ISR)

*Seeded

Referees:			

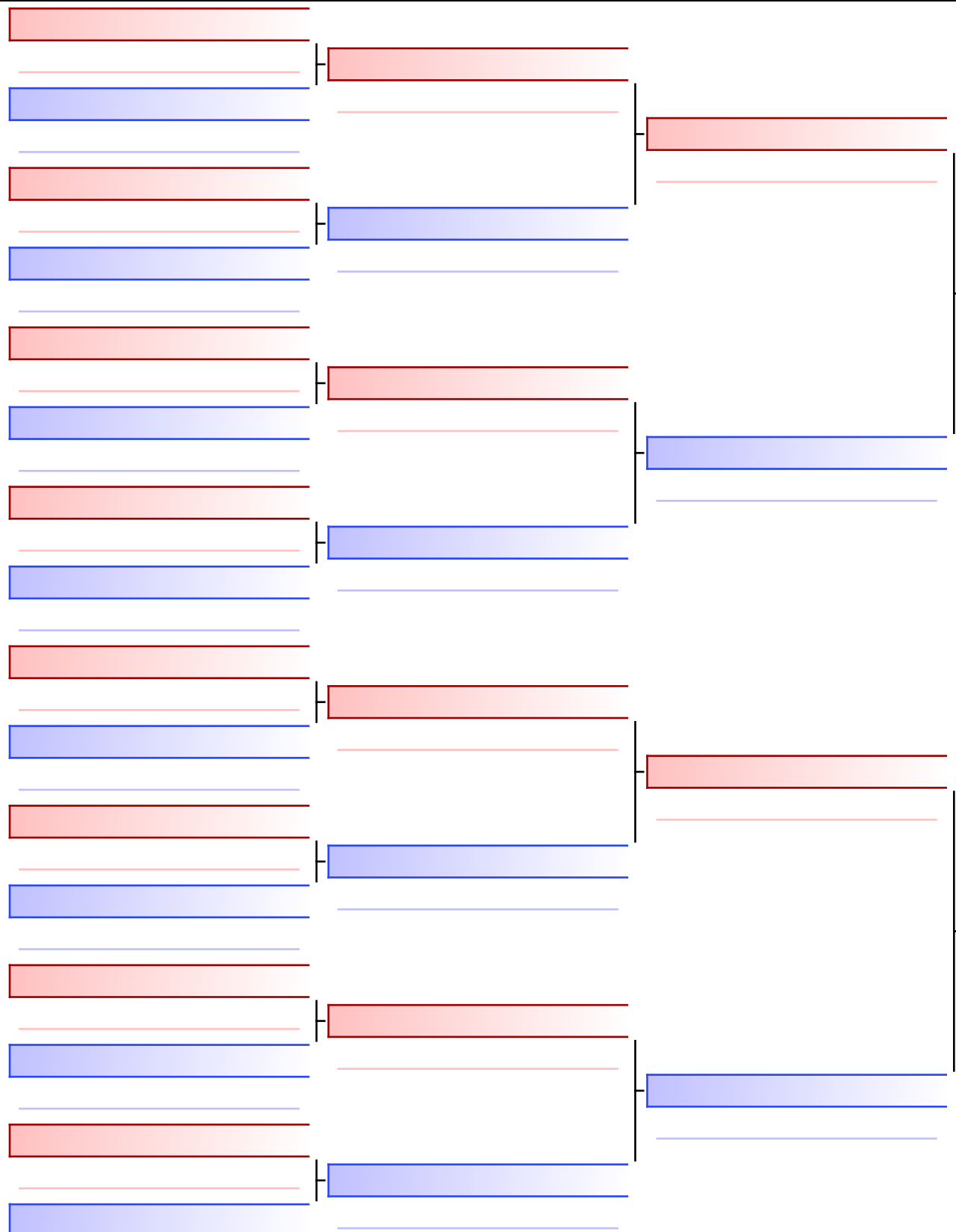

Final

 SPAIN (ESP)
 001 Anan 0

#1015 / 08.02

 (*1) ITALY (ITA)

 (*1) ITALY (ITA)
 099 Unsu 5



1. ITALY (ITA)
2. SPAIN (ESP)
3. GERMANY (GER)
3. SLOVAKIA (SVK)
5. POLAND (POL)
5. FRANCE (FRA)
7. ISRAEL (ISR)

*Seeded

Referees:			

Kata Team Cadet and Junior Male

EKF Junior, Cadet & U21 Championships 2026 - Limassol

2026-02-07

Tatami
5 09:50

Pool
1

(c)sportdata GmbH & Co KG 2000-2026 (2026-02-08 17:46) v 11.0.0 build 2 (2025-01-21 11:49 CET) License: SDIL TWG2025 (expire 2026-09-30)

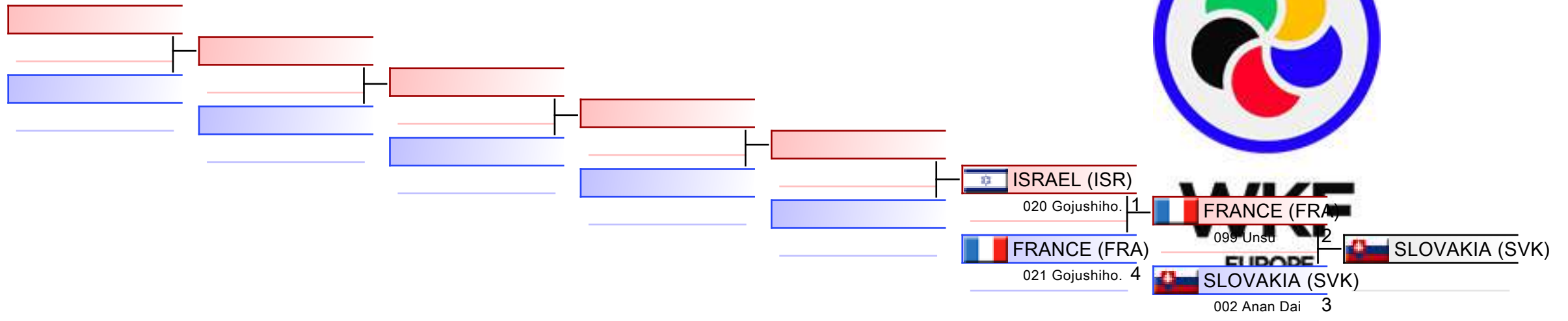

REPECHAGE: (1)

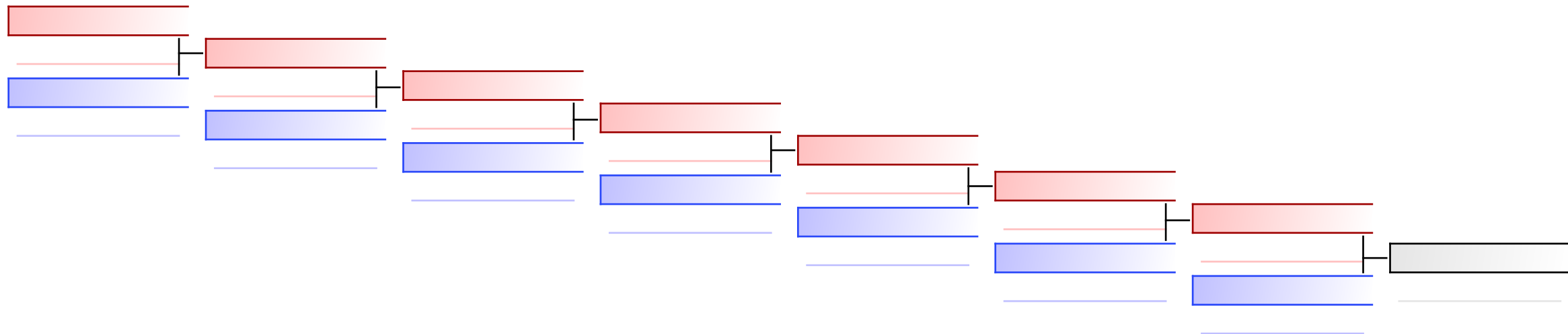

Referees:							
-----------	--	--	--	--	--	--	--

Kata Team Cadet and Junior Male

EKF Junior, Cadet & U21 Championships 2026 - Limassol

2026-02-07

Tatami
6 09:40

Pool
2

(c)sportdata GmbH & Co KG 2000-2026 (2026-02-08 17:46) v 11.0.0 build 2 (2025-01-21 11:49 CET) License: SDIL TWG2025 (expire 2026-09-30)

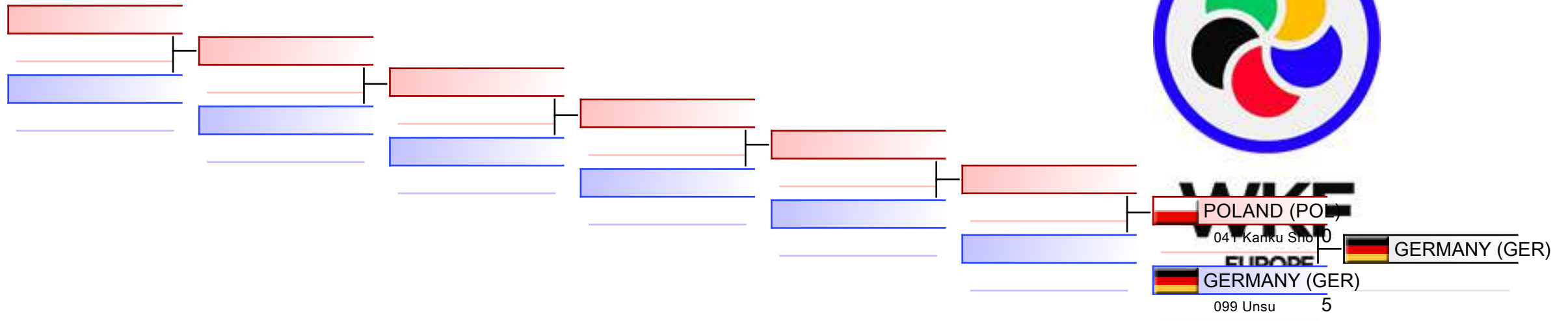

REPECHAGE: (2)

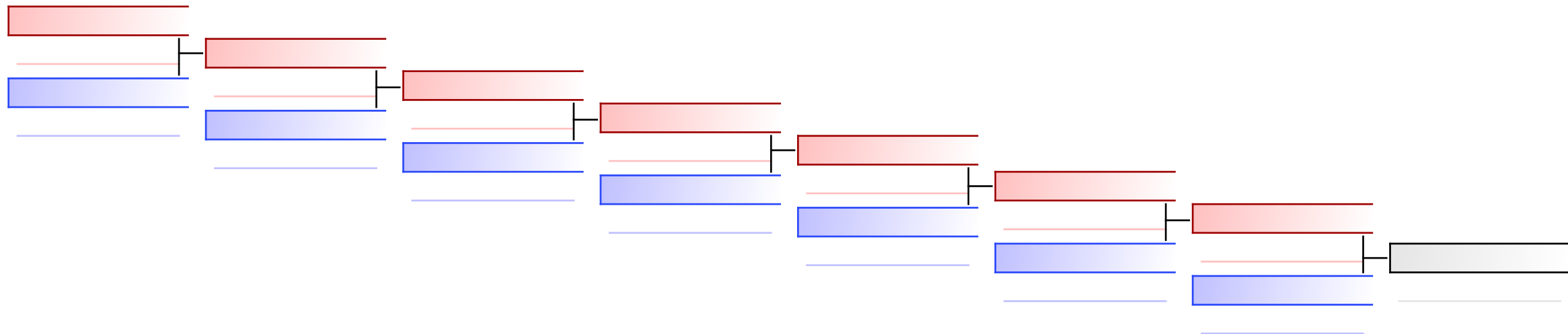







Referees:							
-----------	--	--	--	--	--	--	--



EKF Junior, Cadet & U21 Championships
2026 - Limassol - 2026-02-06



Official Results

Kata Team Cadet and Junior Male		
1	ITALY - FREDA MATTEO - NARDACCIO MATTEO - PUTELLI NICOLO - ROSIELLO MARCO	 ITA - ITALY
2	SPAIN - ALVAREZ FERNANDEZ IZAN - CARMONA DIAZ ENRIQUE - GONZALEZ SAEZ HUGO - LEON DE LA PENNA JOSE ANGEL	 ESP - SPAIN
3	GERMANY - ATHANASSIAS APOSTOLOS - GSCHWIND VICTOR - KUNYASU HARUAKI	 GER - GERMANY
3	SLOVAKIA - BABEL BRANISLAV - MACKO PETER - ORAVCIK JURAJ - STUSKA SAMUEL	 SVK - SLOVAKIA
5	POLAND - GRZESLO IGOR - KOLACKOV LEON - MYDLARZ MICHAL - NIEDZIELA MICHAL	 POL - POLAND
5	FRANCE - FRANCES ADRIEN - HUYET-DUMONG THOMAS - PILLANT METIS - RAMDANI MOHAMMED HAROUN	 FRA - FRANCE
7	ISRAEL - DE LEVIE YANNAI - KAUFMAN NETA - RABAN NIV	 ISR - ISRAEL

U21 KATA FEMALE



EKF Junior, Cadet & U21 Championships 2026 - Lim..

ENTRIES BY WEIGHT CATEGORY



U21 Kata Female

As of 8 FEB 2026

Code	ID	Gender	Name	Seeding
AZE	AZE02563	F	HEYDAROVA RAMILA	
CRO	CRO03371	F	SEGAVCIC KATIA	
CYP	CYP02931	F	PAPAPHILIPPOU CONSTANTINA	
CZE	CZE02423	F	KIRSCHNEROVA ALICE-JANA	2
DEN	DEN02841	F	DAHL-WROENDING JUSTINA	
ENG	ENG003603	F	CARTWRIGHT CONI MAE	
ESP	ESP02672	F	GARCIA LOZANO PAOLA	1
FRA	FRA02791	F	BUI MAI LINH	3
GEO	GEO02871	F	KHURTSILAVA LIA	
GER	GER03126	F	JAY SHIRLEY	
GRE	GRE02495	F	TSIAKMAKI ATHINA	
HUN	HUN02761	F	HOGENBURG LUCA	
IRL	IRL003100	F	HARNEY ANNA	
ISR	ISR02583	F	ROKAH MIA	
ITA	ITA04188	F	DOMINICI ROBERTA	
LUX	LUX2154	F	REDING MIA	
MKD	MKD2387	F	STOJKOVA DANKA	
MLT	MLT2116	F	VELLA JESSICA	
MNE	MNE2253	F	MILIC JOVANA	
POL	POL2854	F	WYSOCKA EMILIA	
POR	POR02707	F	TEIXEIRA LARA	4
ROU	ROU03101	F	BACIU MARIA	
SLO	SLO2423	F	LISINOVIC ELMA	
SRB	SRB03033	F	MILOSEVIC NEDA	
SVK	SVK02760	F	KADLECAJOVA VIKTORIA	
SWE	SWE003402	F	NYBERG STELLA	
UKR	UKR003742	F	GOLOD ANASTASIIA	
WKF-1	AIN-1006343	F	NOVICIKHINA ELENA	

U21 Kata Female

EKF Junior, Cadet & U21 Championships 2026 - Limassol, Spyros Kyprianou Athletic Center, Limassol, CYP

2026-02-06

Tatami
1 11:15

Pool
1/4



WKF
EUROPE

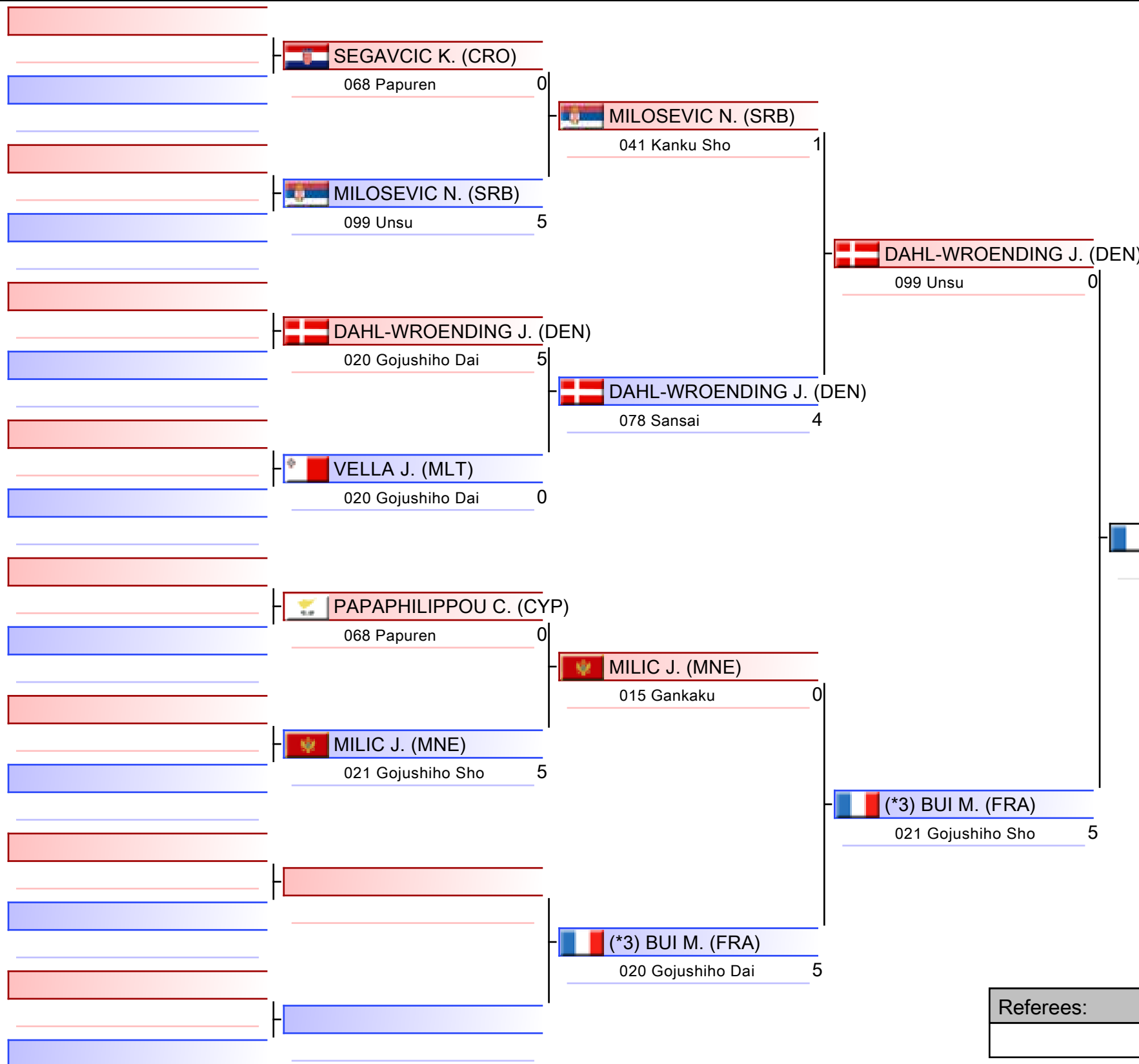

1. GARCIA LOZANO PAOLA (ESP)
2. BUI MAI LINH (FRA)
3. MILIC JOVANA (MNE)
3. DOMINICI ROBERTA (ITA)
5. WYSOCKA EMILIA (POL)
5. KHURTSILAVA LIA (GEO)
7. DAHL-WROENDING JUSTINA (DEN)
7. STOJKOVA DANKA (MKD)

*Seeded

Referees:			

U21 Kata Female

EKF Junior, Cadet & U21 Championships 2026 - Limassol, Spyros Kyprianou Athletic Center, Limassol, CYP

2026-02-06

Tatami
2 11:15

Pool
2/4



WKF
EUROPE

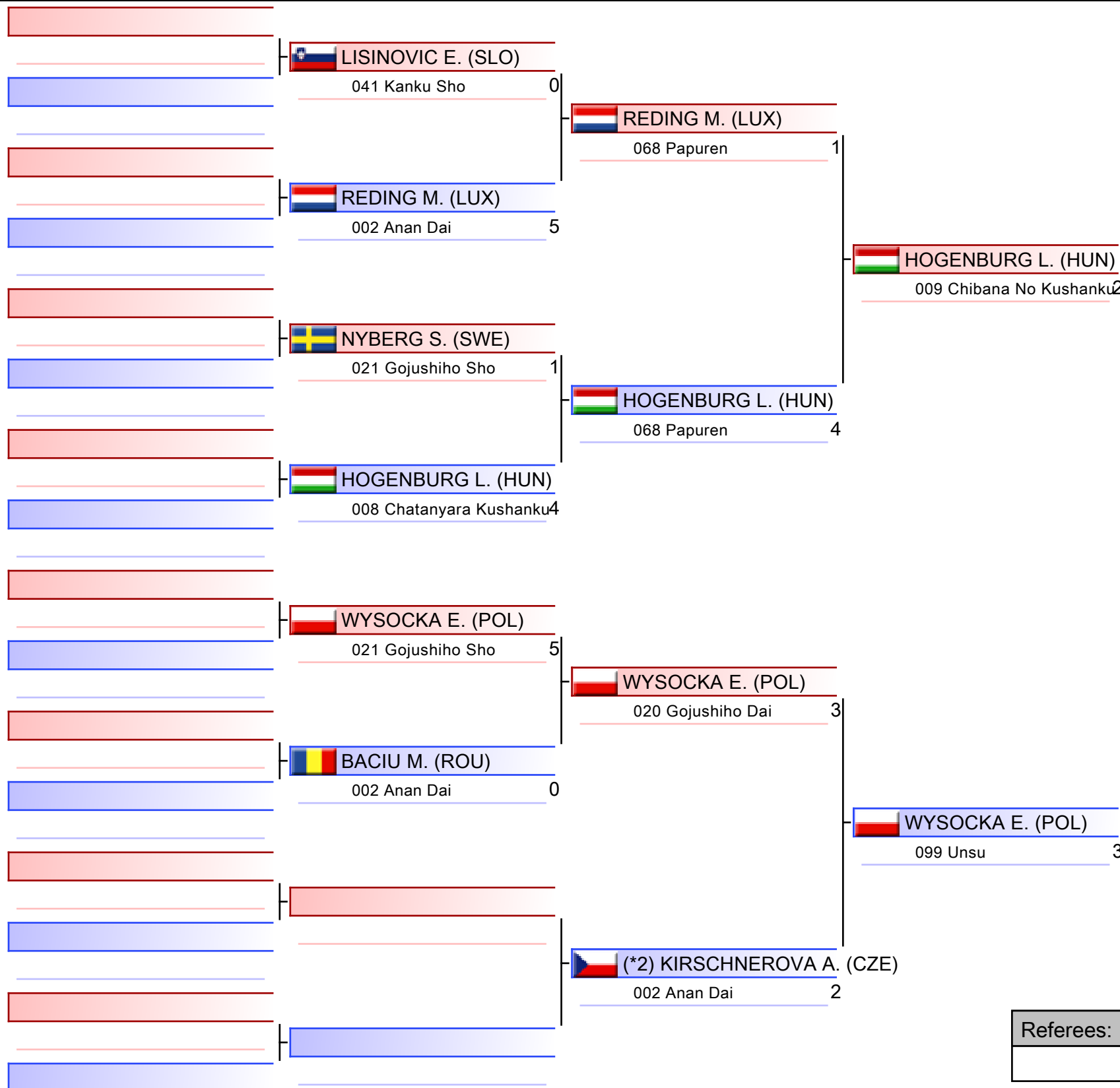

1. GARCIA LOZANO PAOLA (ESP)
2. BUI MAI LINH (FRA)
3. MILIC JOVANA (MNE)
3. DOMINICI ROBERTA (ITA)
5. WYSOCKA EMILIA (POL)
5. KHURTSILAVA LIA (GEO)
7. DAHL-WROENDING JUSTINA (DEN)
7. STOJKOVA DANKA (MKD)

*Seeded

Referees:			

U21 Kata Female

EKF Junior, Cadet & U21 Championships 2026 - Limassol, Spyros Kyprianou Athletic Center, Limassol, CYP

2026-02-06

Tatami
3 11:15

Pool
3/4



WKF
EUROPE

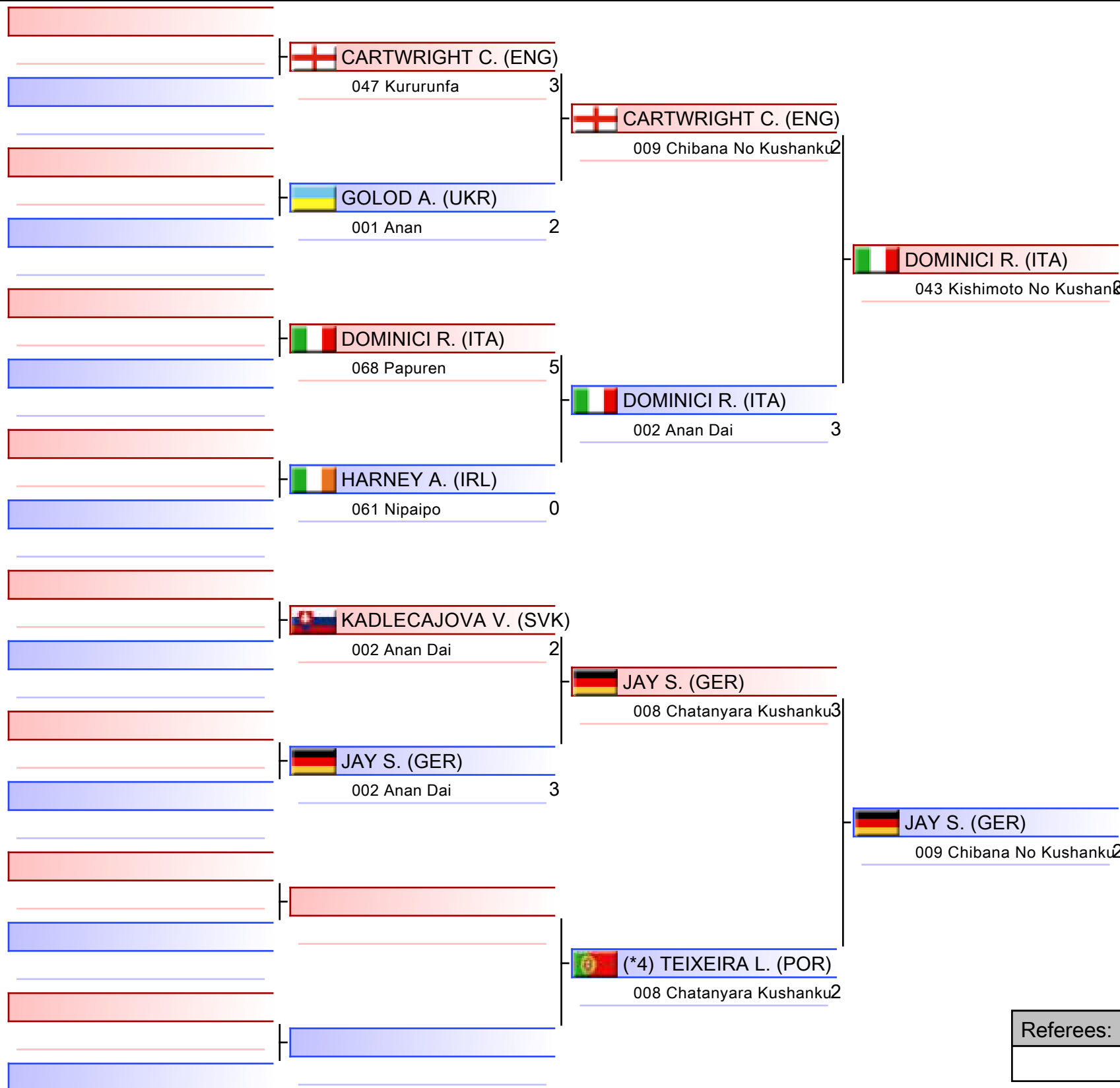

1. GARCIA LOZANO PAOLA (ESP)
2. BUI MAI LINH (FRA)
3. MILIC JOVANA (MNE)
3. DOMINICI ROBERTA (ITA)
5. WYSOCKA EMILIA (POL)
5. KHURTSILAVA LIA (GEO)
7. DAHL-WROENDING JUSTINA (DEN)
7. STOJKOVA DANKA (MKD)

*Seeded

Referees:			

U21 Kata Female

EKF Junior, Cadet & U21 Championships 2026 - Limassol, Spyros Kyprianou Athletic Center, Limassol, CYP

2026-02-06

Tatami
4 11:15

Pool
4/4



WKF
EUROPE

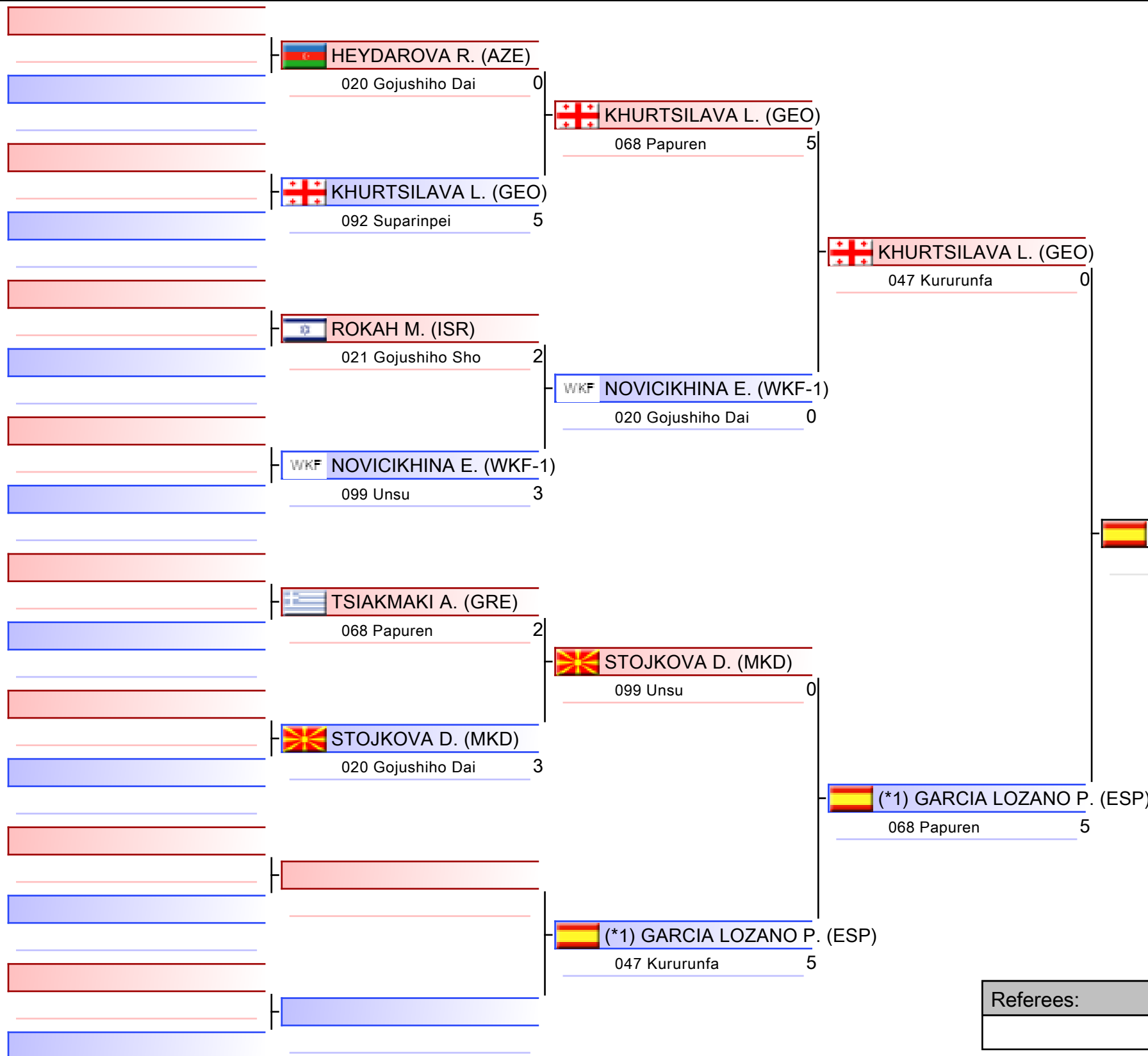

(*1) GARCIA LOZANO P. (ESP)

1. GARCIA LOZANO PAOLA (ESP)
2. BUI MAI LINH (FRA)
3. MILIC JOVANA (MNE)
3. DOMINICI ROBERTA (ITA)
5. WYSOCKA EMILIA (POL)
5. KHURTSILAVA LIA (GEO)
7. DAHL-WROENDING JUSTINA (DEN)
7. STOJKOVA DANKA (MKD)

*Seeded

Referees:			

Pool winner-U21 Kata Female

EKF Junior, Cadet & U21 Championships 2026 - Limassol, Spyros Kyprianou Athletic Center, Limsassol, CYP

2026-02-06

Tatami
1 12:05

Pool
1/1

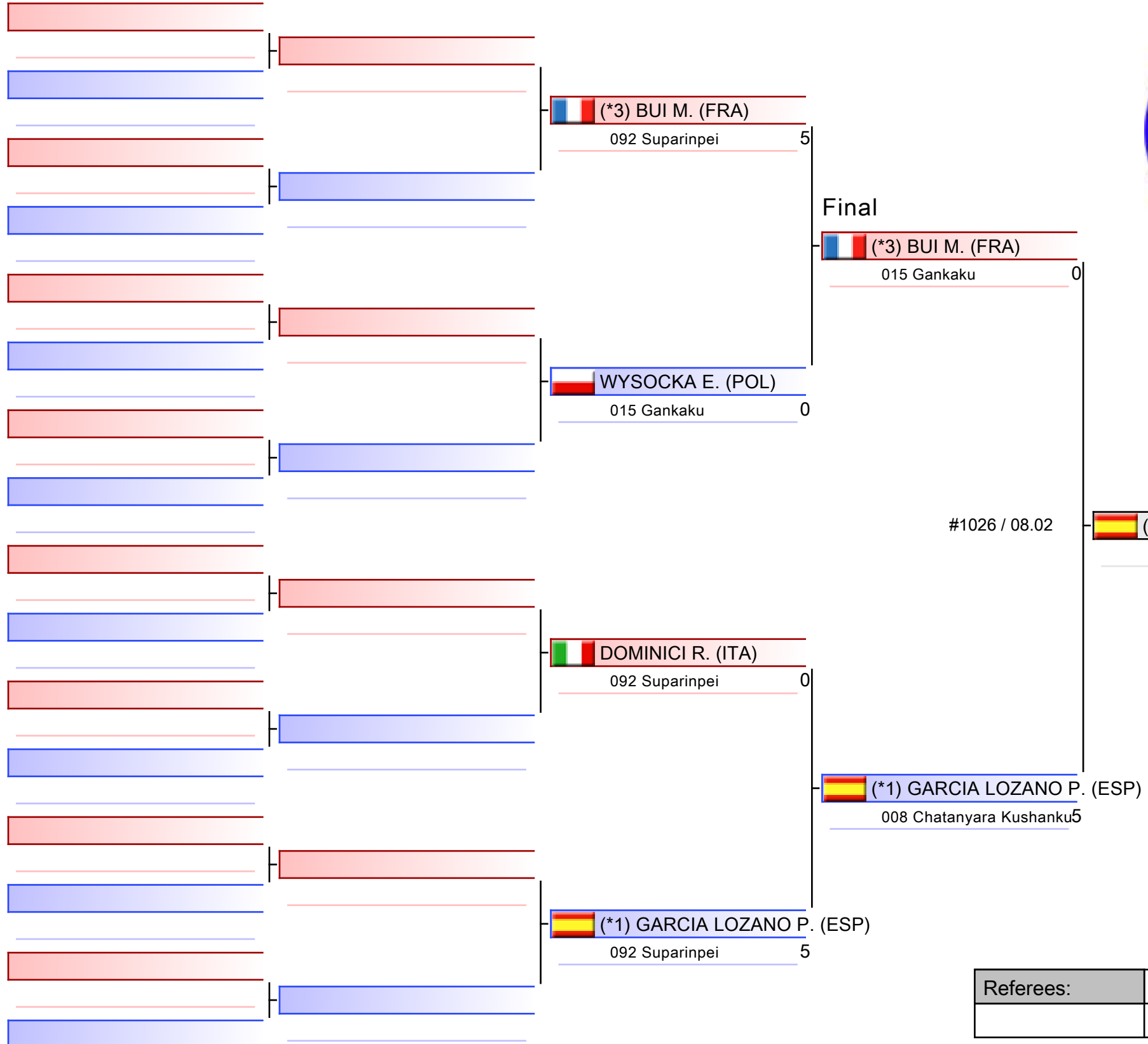

WKF
EUROPE

1. GARCIA LOZANO PAOLA (ESP)
2. BUI MAI LINH (FRA)
3. MILIC JOVANA (MNE)
3. DOMINICI ROBERTA (ITA)
5. WYSOCKA EMILIA (POL)
5. KHURTSILAVA LIA (GEO)
7. DAHL-WROENDING JUSTINA (DEN)
7. STOJKOVA DANKA (MKD)

*Seeded

Referees:			

U21 Kata Female

EKF Junior, Cadet & U21 Championships 2026 - Limassol

2026-02-06

Tatami
5 12:15

Pool
1,2

(c)sportdata GmbH & Co KG 2000-2026 (2026-02-08 17:46) v 11.0.0 build 2 (2025-01-21 11:49 CET) License: SDIL TWG2025 (expire 2026-09-30)



#9 / 06.02

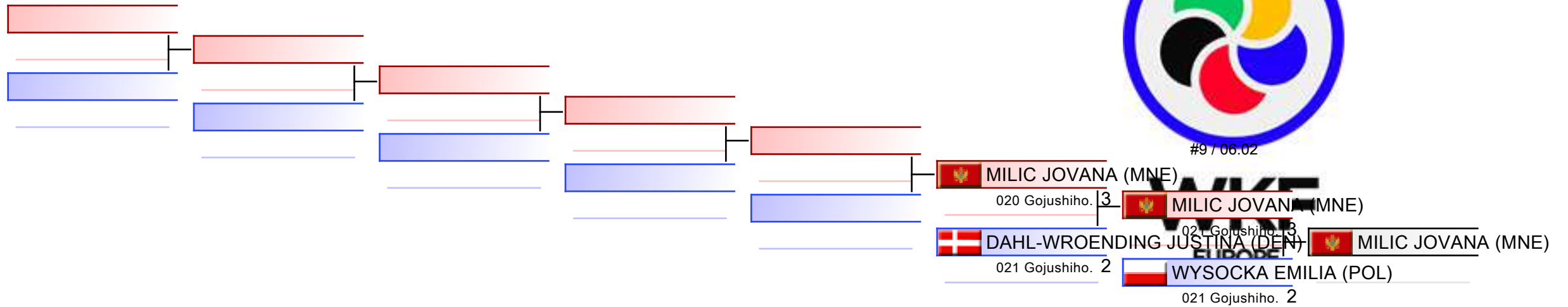

REPECHAGE: (1,2)

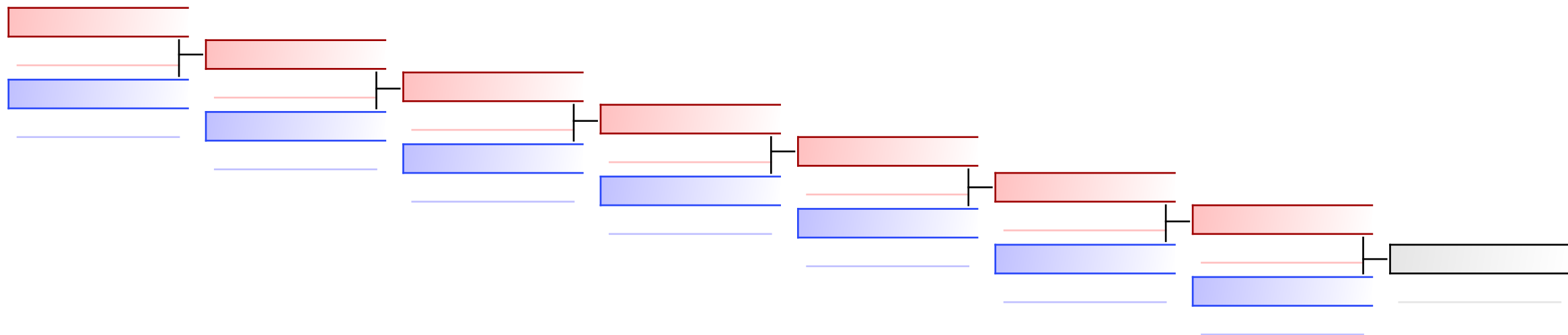

Referees:							
-----------	--	--	--	--	--	--	--

U21 Kata Female

EKF Junior, Cadet & U21 Championships 2026 - Limassol

2026-02-06

Tatami
6 12:15

Pool
3,4

(c)sportdata GmbH & Co KG 2000-2026 (2026-02-08 17:46) v 11.0.0 build 2 (2025-01-21 11:49 CET) License: SDIL TWG2025 (expire 2026-09-30)



#10 / 06.02

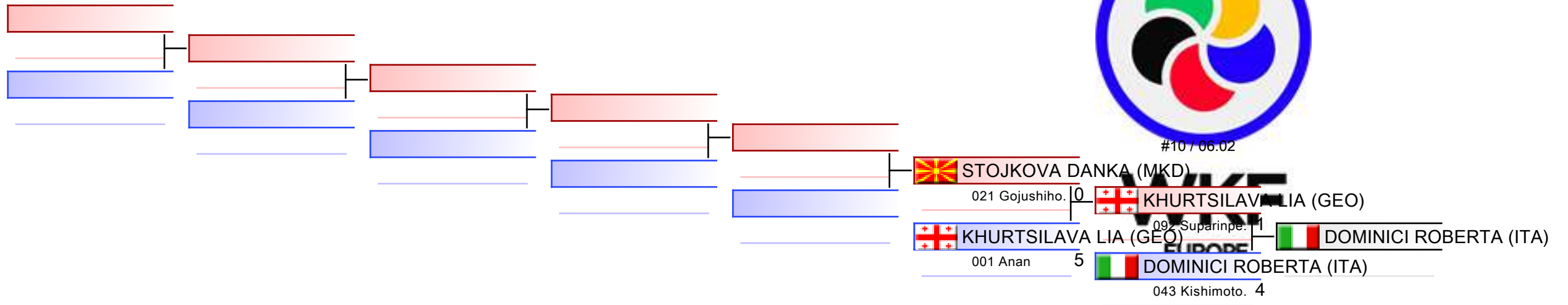

REPECHAGE: (3,4)

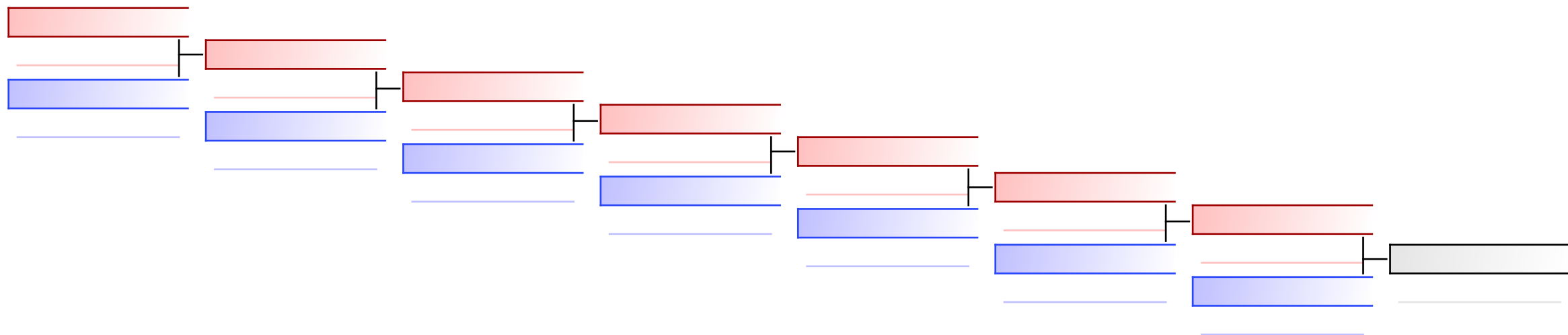

Referees:							
-----------	--	--	--	--	--	--	--



EKF Junior, Cadet & U21 Championships
2026 - Limassol - 2026-02-06



Official Results

U21 Kata Female			
1	GARCIA LOZANO PAOLA		ESP - SPAIN
2	BUI MAI LINH		FRA - FRANCE
3	MILIC JOVANA		MNE - MONTENEGRO
3	DOMINICI ROBERTA		ITA - ITALY
5	WYSOCKA EMILIA		POL - POLAND
5	KHURTSILAVA LIA		GEO - GEORGIA
7	DAHL-WROENDING JUSTINA		DEN - DENMARK
7	STOJKOVA DANKA		MKD - NORTH MACEDONIA

U21 KATA MALE



EKF Junior, Cadet & U21 Championships 2026 - Lim..



ENTRIES BY WEIGHT CATEGORY

U21 Kata Male

As of 8 FEB 2026

Code	ID	Gender	Name	Seeding
AUT	AUT02600	M	ZOECHLING FLORIAN	4
BIH	BIH2657	M	RAMIC FARIS	
BUL	BUL2139	M	MATUSKI GEORGI	
CRO	CRO2641	M	FILES MARK	
CYP	CYP02820	M	VOUZOUNIS PANTELIS	
CZE	CZE02259	M	ZLABEK JAKUB	
DEN	DEN02568	M	VEISTRUP DAVID	
ENG	ENG003390	M	ROWE BRANDON	
ESP	ESP02671	M	MARTIN MONTENEGRO IVAN	
FIN	FIN002714	M	TAKALA AKSELI	
FRA	FRA02808	M	HOFFMANN LUCAS	2
GER	GER03128	M	LUECK ANDREW LYLE	
GRE	GRE02494	M	TSIAKMAKIS FOTIOS	
IRL	IRL003097	M	SCANNELL JACK	
ISR	ISR02468	M	MANSOR CARMEL	
ITA	ITA03831	M	PAPPALARDO VINCENZO	3
LUX	LUX02431	M	CHAFFORT LUCAS	
MKD	MKD2545	M	DIMOVSKI MARKO	
NED	NED003577	M	BURGHOUT DAAN	
POL	POL2951	M	NIEDZIELA WOJCIECH	
POR	POR02704	M	VIEIRA JOAO	
ROU	ROU2577	M	MODI ALEXANDRU NICOLAS	
SRB	SRB2536	M	BOSKOV ALEKSANDAR	
SUI	SUI003155	M	PETRONE LEANDRO	
SVK	SVK2210	M	KODAJ SIMON	
SWE	SWE02584	M	VU ANTHONY	1
UKR	UKR03385	M	SEMENENKO NIKITA	
WAL	WAL002521	M	BEARDS JAMES	
WKF-1	RUS04232	M	ANUCHIN PAVEL	

U21 Kata Male

EKF Junior, Cadet & U21 Championships 2026 - Limassol, Spyros Kyprianou Athletic Center, Limassol, CYP

2026-02-06

Tatami
5 11:10

Pool
1/4



WKF
EUROPE

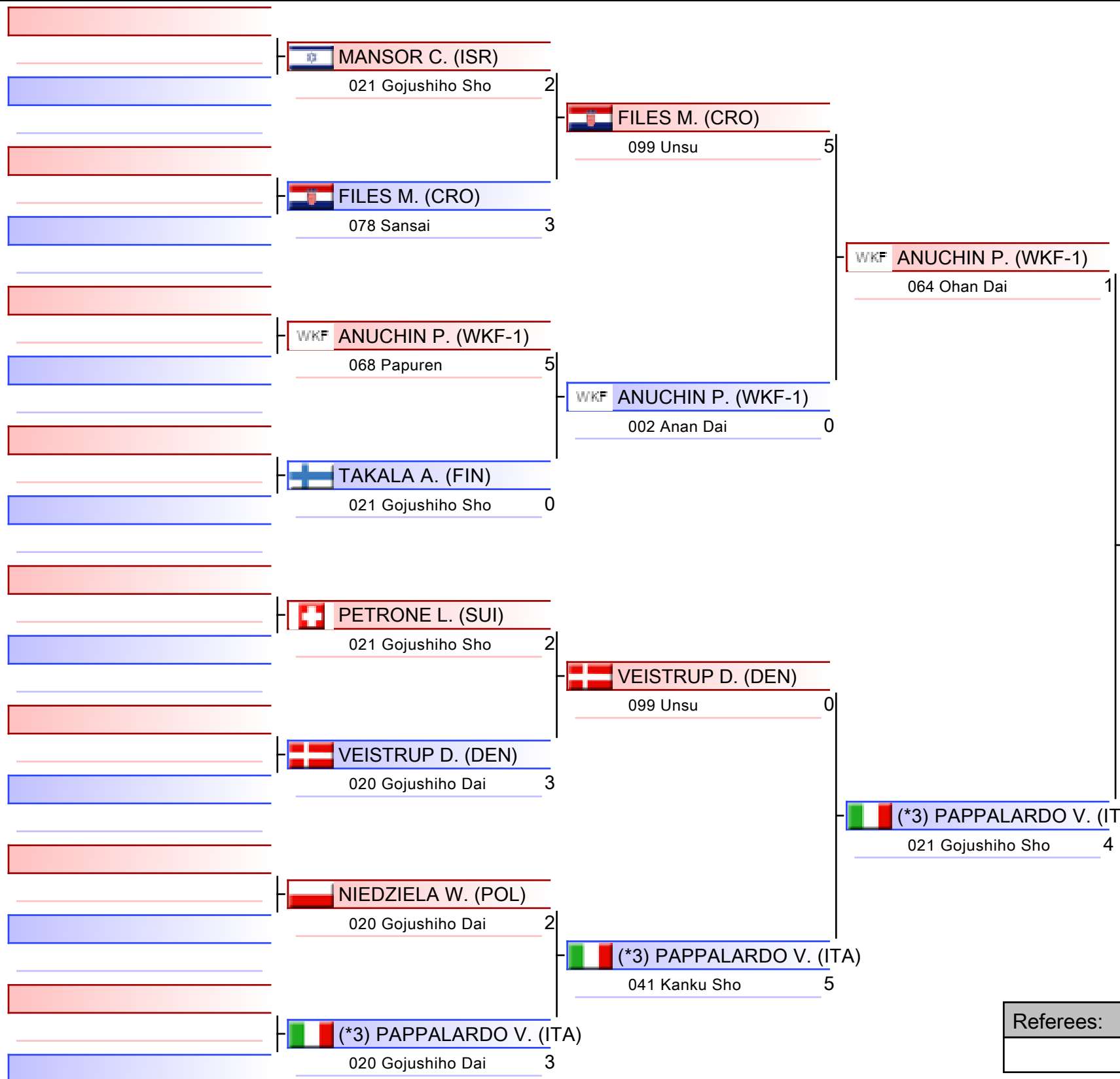

(*3) PAPPALARDO V. (ITA)

1. MARTIN MONTENEGRO IVAN (ESP)
2. VU ANTHONY (SWE)
3. PAPPALARDO VINCENZO (ITA)
3. VIEIRA JOAO (POR)
5. MODI ALEXANDRU NICOLAS (ROU)
5. ZLABEK JAKUB (CZE)
7. HOFFMANN LUCAS (FRA)
7. KODAJ SIMON (SVK)

*Seeded

Referees:			

U21 Kata Male

EKF Junior, Cadet & U21 Championships 2026 - Limassol, Spyros Kyprianou Athletic Center, Limassol, CYP

2026-02-06

Tatami
6 11:10

Pool
2/4



WKF
EUROPE

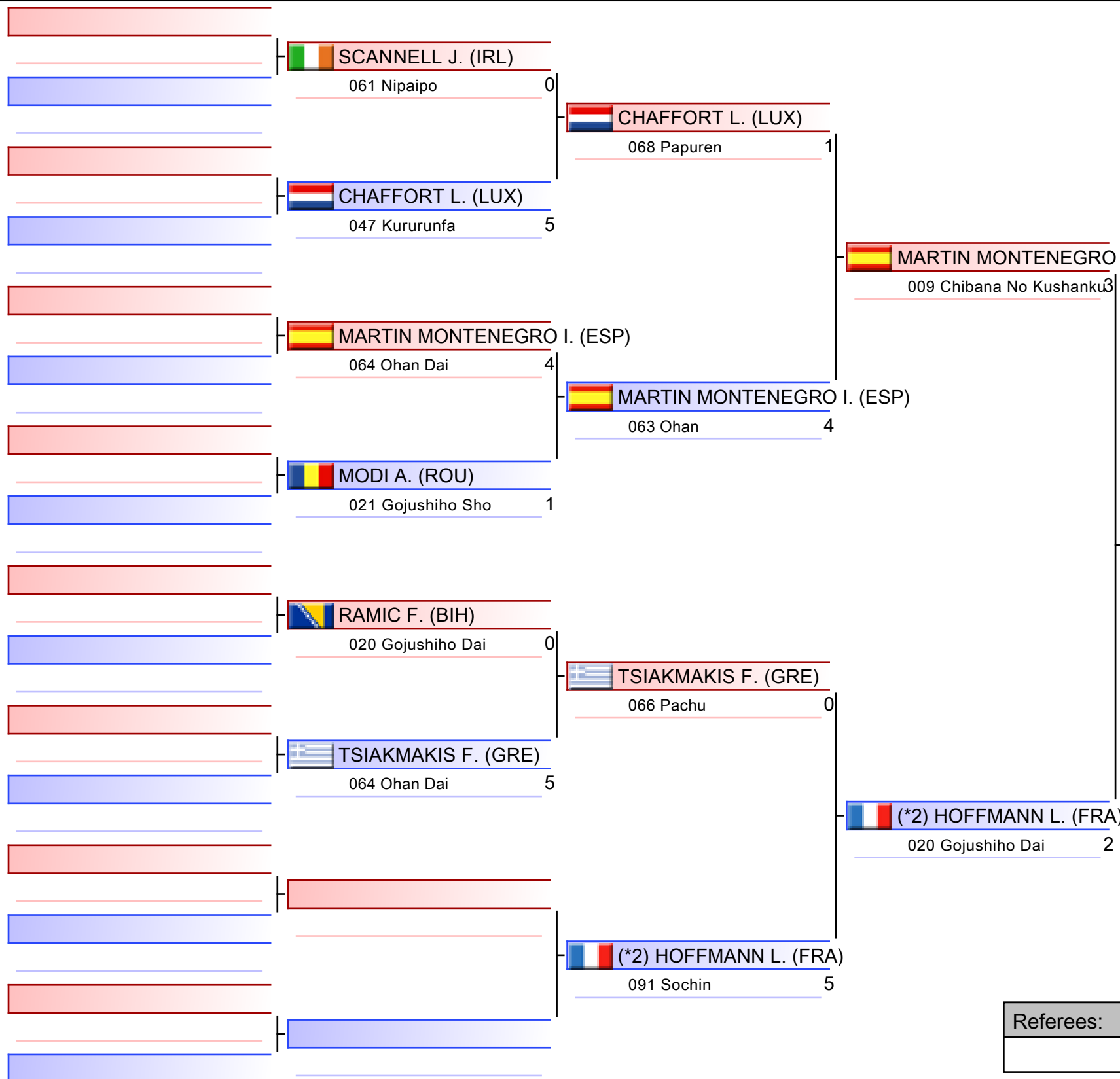

1. MARTIN MONTENEGRO IVAN (ESP)
2. VU ANTHONY (SWE)
3. PAPPALARDO VINCENZO (ITA)
3. VIEIRA JOAO (POR)
5. MODI ALEXANDRU NICOLAS (ROU)
5. ZLABEK JAKUB (CZE)
7. HOFFMANN LUCAS (FRA)
7. KODAJ SIMON (SVK)

*Seeded

Referees:			

U21 Kata Male

EKF Junior, Cadet & U21 Championships 2026 - Limassol, Spyros Kyprianou Athletic Center, Limassol, CYP

2026-02-06

Tatami
7 11:10

Pool
3/4



WKF
EUROPE

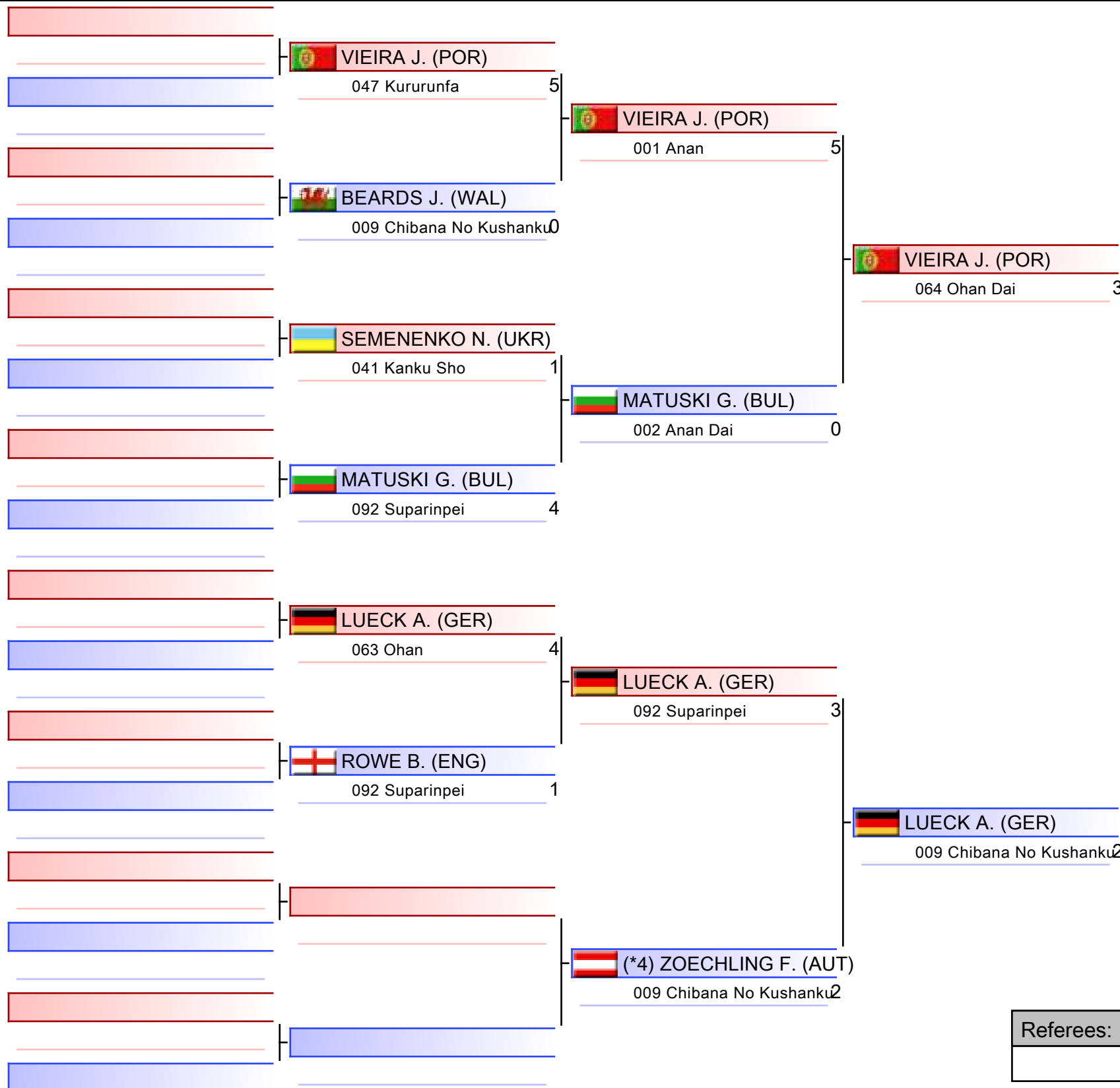

1. MARTIN MONTENEGRO IVAN (ESP)
2. VU ANTHONY (SWE)
3. PAPPALARDO VINCENZO (ITA)
3. VIEIRA JOAO (POR)
5. MODI ALEXANDRU NICOLAS (ROU)
5. ZLABEK JAKUB (CZE)
7. HOFFMANN LUCAS (FRA)
7. KODAJ SIMON (SVK)

*Seeded

Referees:			

U21 Kata Male

EKF Junior, Cadet & U21 Championships 2026 - Limassol, Spyros Kyprianou Athletic Center, Limassol, CYP

2026-02-06

Tatami
8 11:10

Pool
4/4



WKF
EUROPE

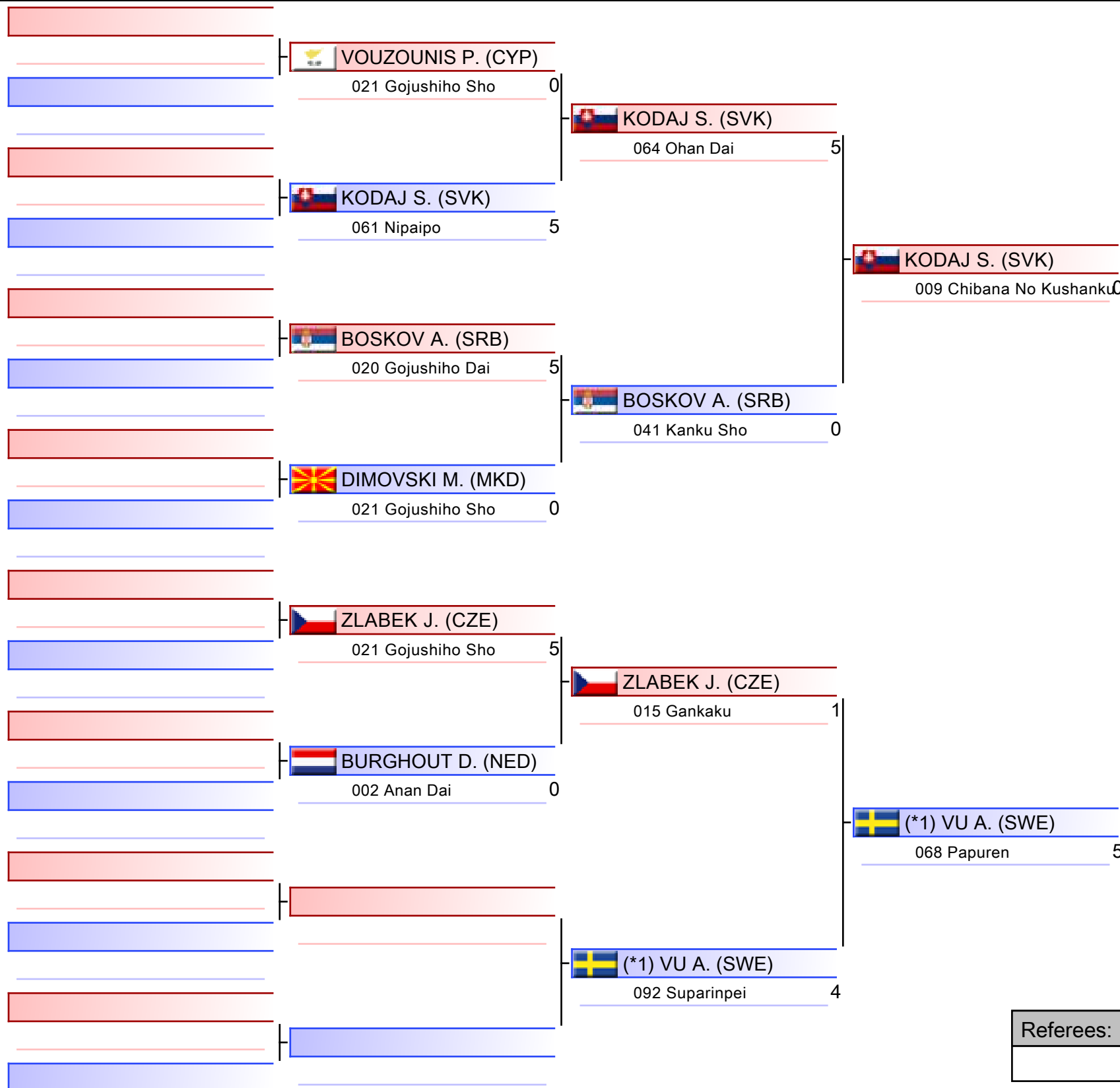

1. MARTIN MONTENEGRO IVAN (ESP)
2. VU ANTHONY (SWE)
3. PAPPALARDO VINCENZO (ITA)
3. VIEIRA JOAO (POR)
5. MODI ALEXANDRU NICOLAS (ROU)
5. ZLABEK JAKUB (CZE)
7. HOFFMANN LUCAS (FRA)
7. KODAJ SIMON (SVK)

*Seeded

Referees:			

Pool winner-U21 Kata Male

EKF Junior, Cadet & U21 Championships 2026 - Limassol, Spyros Kyprianou Athletic Center, Limassol, CYP

2026-02-06

Tatami
5 12:05

Pool
1/1



WKF
EUROPE

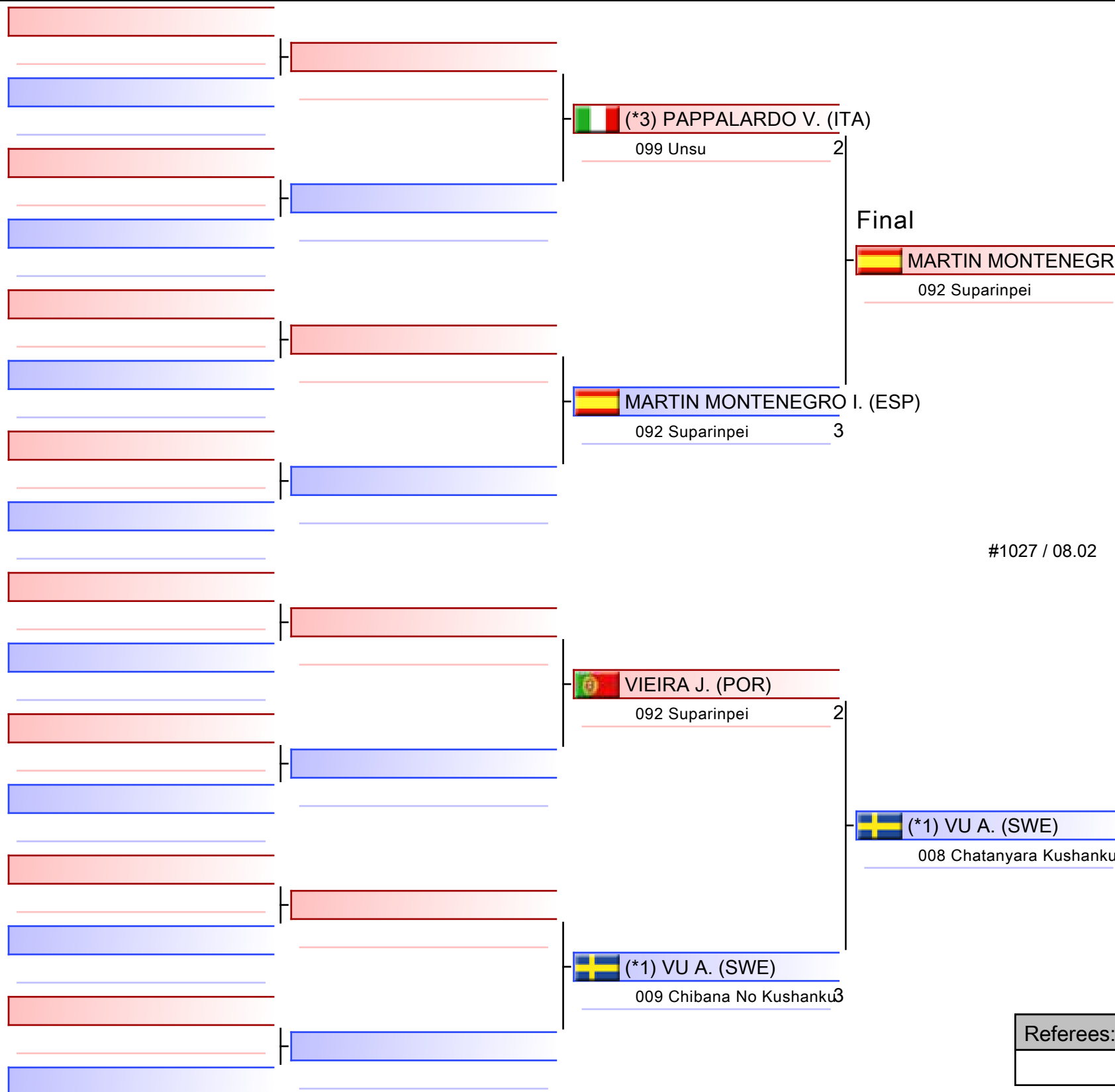

1. MARTIN MONTENEGRO IVAN (ESP)
2. VU ANTHONY (SWE)
3. PAPPALARDO VINCENZO (ITA)
3. VIEIRA JOAO (POR)
5. MODI ALEXANDRU NICOLAS (ROU)
5. ZLABEK JAKUB (CZE)
7. HOFFMANN LUCAS (FRA)
7. KODAJ SIMON (SVK)

*Seeded

Referees:			

U21 Kata Male

EKF Junior, Cadet & U21 Championships 2026 - Limassol

2026-02-06

Tatami

7 12:15

Pool

1,2,3,4

(c)sportdata GmbH & Co KG 2000-2026 (2026-02-08 17:46) v 11.0.0 build 2 (2025-01-21 11:49 CET) License: SDIL TWG2025 (expire 2026-09-30)

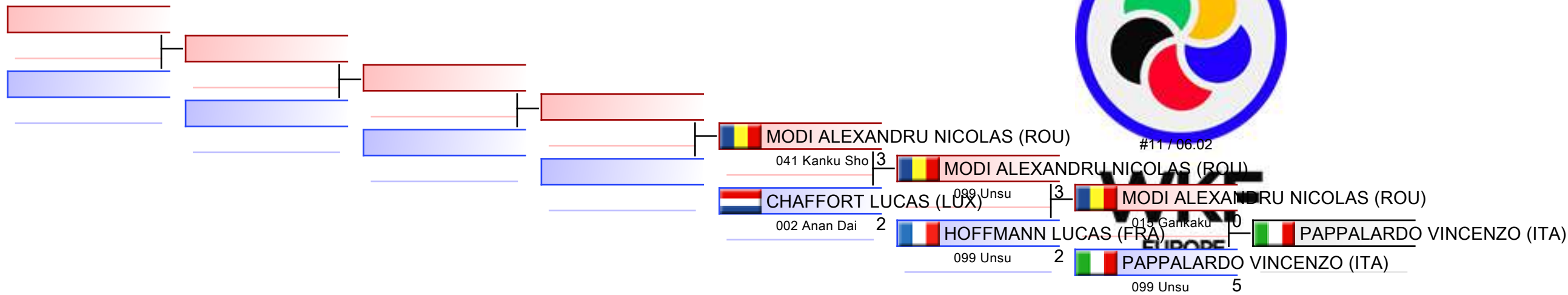

REPECHAGE: (1,2,3,4)

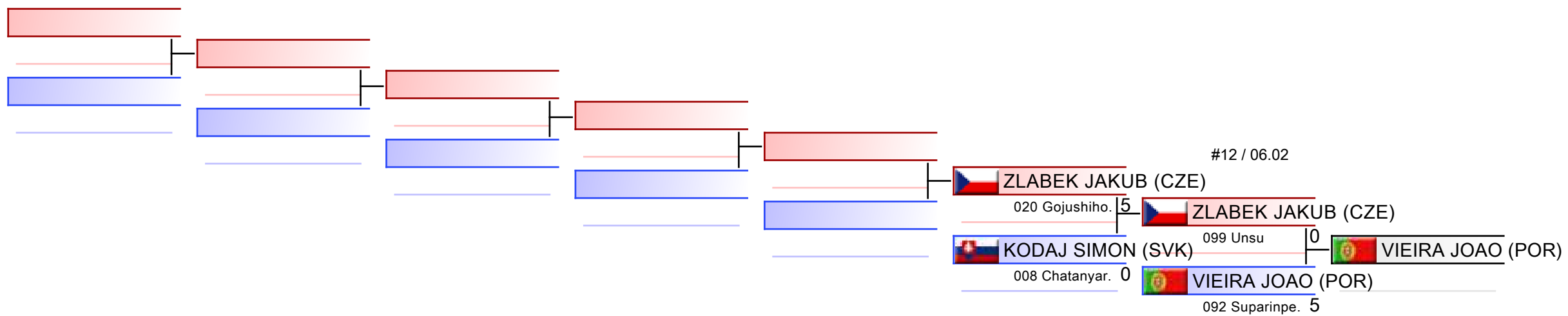

Referees:							
-----------	--	--	--	--	--	--	--



EKF Junior, Cadet & U21 Championships
2026 - Limassol - 2026-02-06



Official Results

U21 Kata Male			
1	MARTIN MONTENEGRO IVAN		ESP - SPAIN
2	VU ANTHONY		SWE - SWEDEN
3	PAPPALARDO VINCENZO		ITA - ITALY
3	VIEIRA JOAO		POR - PORTUGAL
5	MODI ALEXANDRU NICOLAS		ROU - ROMANIA
5	ZLABEK JAKUB		CZE - CZECH REPUBLIC
7	HOFFMANN LUCAS		FRA - FRANCE
7	KODAJ SIMON		SVK - SLOVAKIA
9	CHAFFORT LUCAS		LUX - LUXEMBOURG

U21 KATA TEAM FEMALE



EKF Junior, Cadet & U21 Championships 2026 - Lim..



ENTRIES BY WEIGHT CATEGORY

U21 Kata Team Female

As of 8 FEB 2026

Code	ID	Gender	Name	Seeding
CZE	CZE02423	F	KIRSCHNEROVA ALICE-JANA	
CZE	CZE02610	F	MALAFOVA NATALIE	
CZE	CZE02477	F	NOVAKOVA KATERINA	
CZE	CZE02247	F	ONDROUSKOVA AMALIE	
ESP	ESP004097	F	ANGULO MADRID ABRIL	
ESP	ESP02672	F	GARCIA LOZANO PAOLA	
ESP	ESP003979	F	GUARDENO LEON CARLA	
ESP	ESP004276	F	MARTIN DIAZ ALBA	
GER	GER03868	F	EWALD CLARA	
GER	GER03282	F	JUERGENSMANN ANNIKA	
GER	GER03124	F	STEVENS JULIE	
HUN	HUN02768	F	FODOR AMIRA	
HUN	HUN02761	F	HOGENBURG LUCA	
HUN	HUN02775	F	KISS KITTI	
ITA	ITA2181	F	CRUCITTI FRANCESCA	
ITA	ITA03632	F	DE GREGORIO GABRIELLA	
ITA	ITA04188	F	DOMINICI ROBERTA	
ITA	ITA04248	F	PADOAN MARTINA	
POR	POR03179	F	OLIVEIRA INES	
POR	POR02716	F	RIBEIRO BARBARA	
POR	POR02707	F	TEIXEIRA LARA	

U21 Kata Team Female

EKF Junior, Cadet & U21 Championships 2026 - Limassol, Spyros Kyprianou Athletic Center, Limassol, CYP

2026-02-07

Tatami
7 09:00

Pool
1/2



WKF
EUROPE

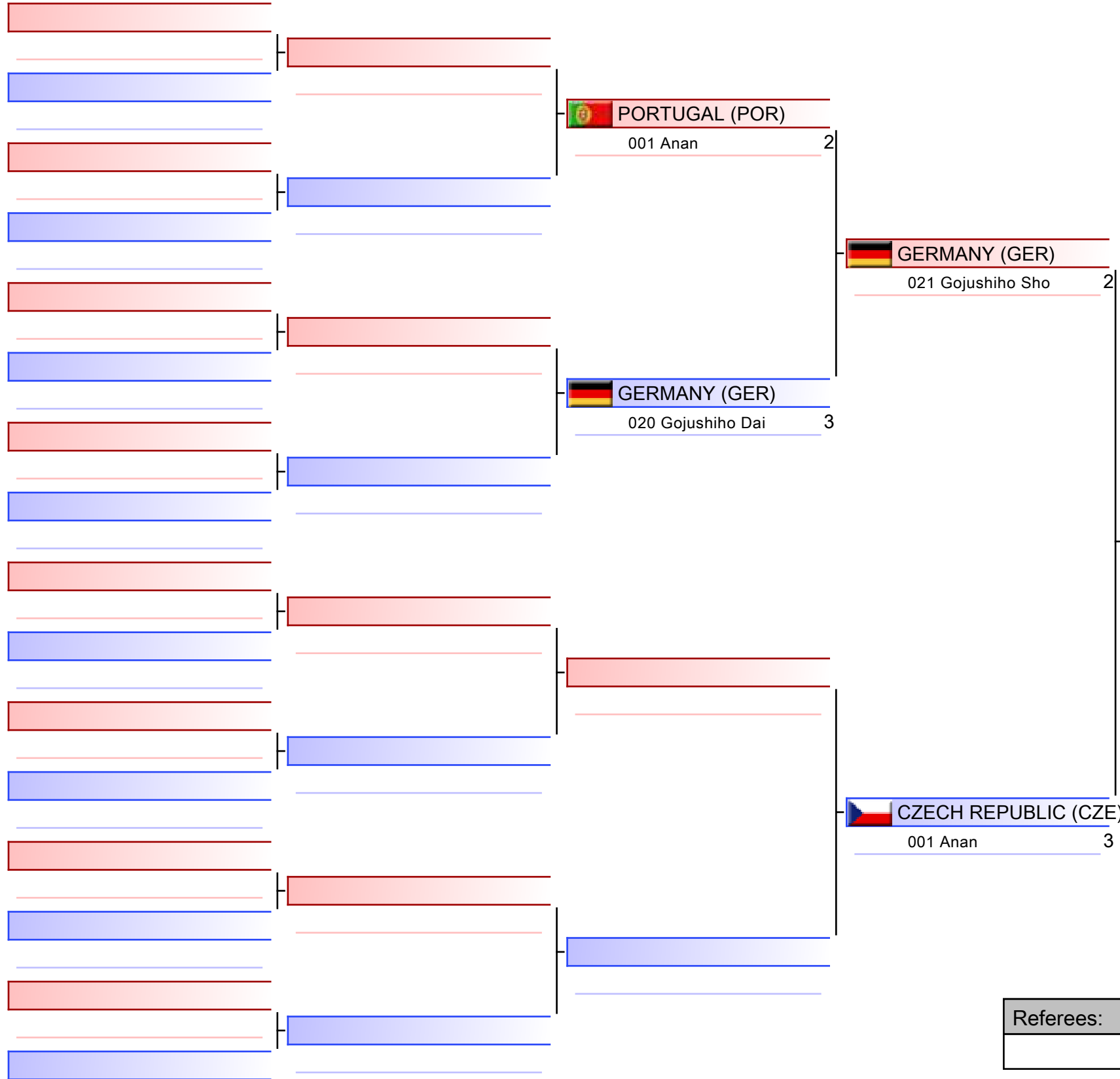

CZECH REPUBLIC (CZE)

1. CZECH REPUBLIC (CZE)
2. SPAIN (ESP)
3. GERMANY (GER)
3. ITALY (ITA)

Referees:			

U21 Kata Team Female

EKF Junior, Cadet & U21 Championships 2026 - Limassol, Spyros Kyprianou Athletic Center, Limassol, CYP

2026-02-07

Tatami
8 09:00

Pool
2/2



WKF
EUROPE

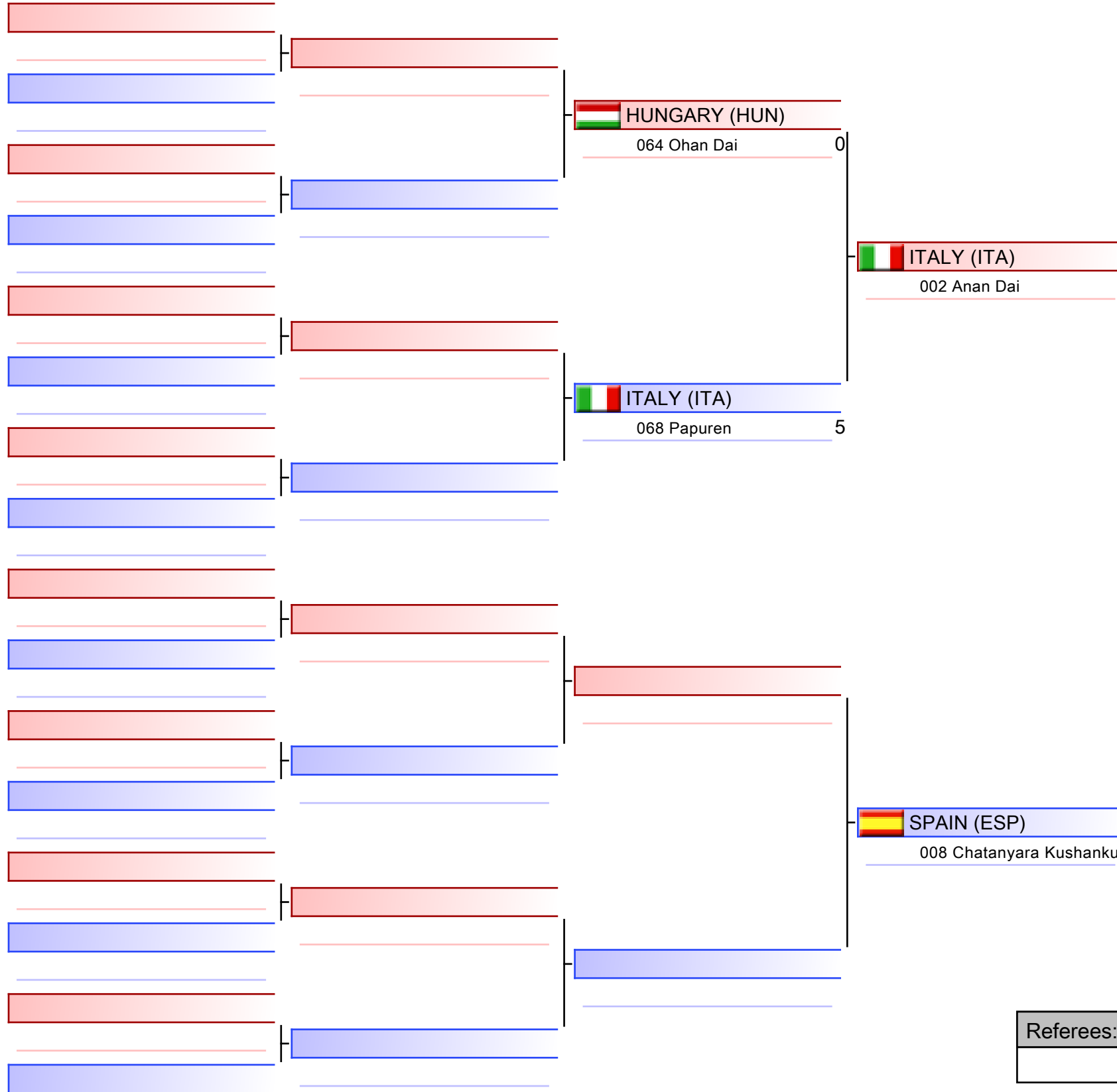

SPAIN (ESP)

1. CZECH REPUBLIC (CZE)
2. SPAIN (ESP)
3. GERMANY (GER)
3. ITALY (ITA)

Referees:			

Pool winner-U21 Kata Team Female

EKF Junior, Cadet & U21 Championships 2026 - Limassol, Spyros Kyprianou Athletic Center, Limsassol, CYP

Tatami

Pool
1/1

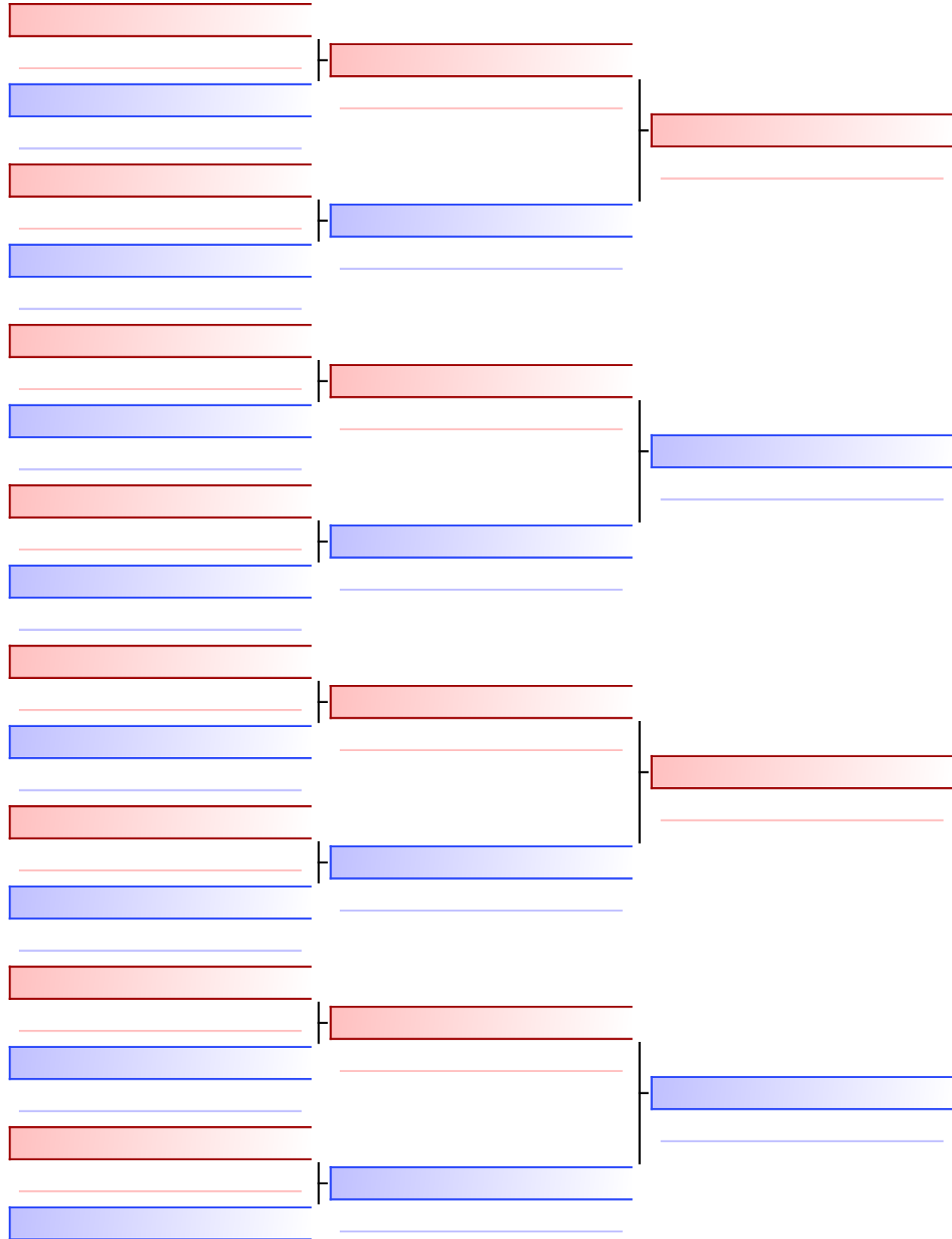

Final

 CZECH REPUBLIC (CZE)
030 Heiku 5

#1028 / 08.02

 CZECH REPUBLIC (CZE)

 SPAIN (ESP)
001 Anan 0



WKF
EUROPE

- | |
|-------------------------|
| 1. CZECH REPUBLIC (CZE) |
| 2. SPAIN (ESP) |
| 3. GERMANY (GER) |
| 3. ITALY (ITA) |
| |
| |
| |

Referees:			

U21 Kata Team Female

EKF Junior, Cadet & U21 Championships 2026 - Limassol

2026-02-07

Tatami
7 09:40

Pool
1,2

(c)sportdata GmbH & Co KG 2000-2026 (2026-02-08 17:46) v 11.0.0 build 2 (2025-01-21 11:49 CET) License: SDIL TWG2025 (expire 2026-09-30)

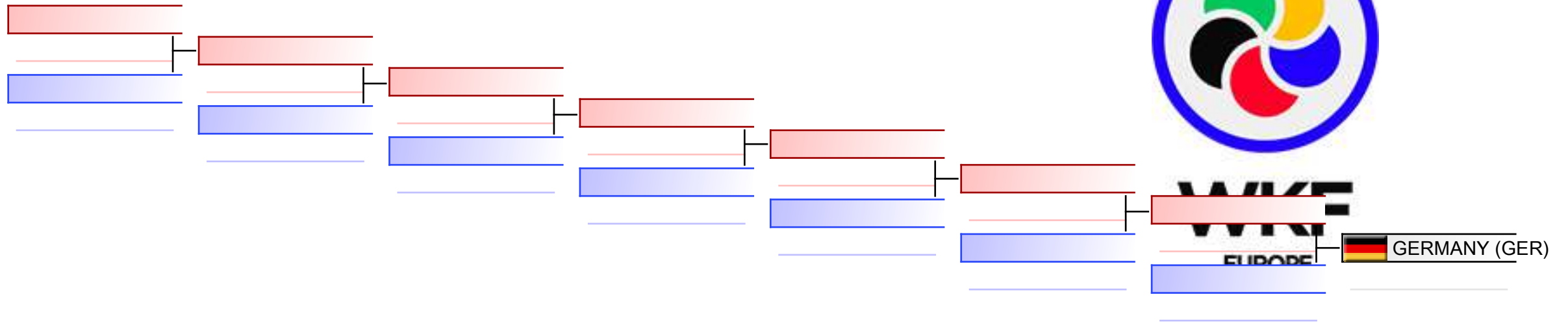

REPECHAGE: (1,2)

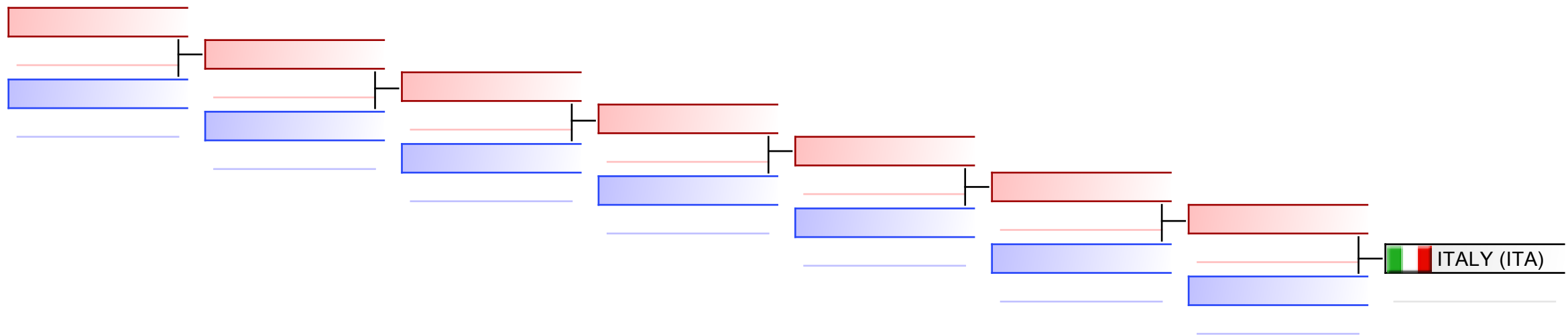

Referees:							
-----------	--	--	--	--	--	--	--



EKF Junior, Cadet & U21 Championships
2026 - Limassol - 2026-02-06



Official Results

U21 Kata Team Female			
1	CZECH REPUBLIC - KIRSCHNEROVA ALICE-JANA - MALAFOVA NATALIE - NOVAKOVA KATERINA - ONDROUSKOVA AMALIE		CZE - CZECH REPUBLIC
2	SPAIN - ANGULO MADRID ABRIL - GARCIA LOZANO PAOLA - GUARDENO LEON CARLA - MARTIN DIAZ ALBA		ESP - SPAIN
3	GERMANY - EWALD CLARA - JUERGENSMANN ANNIKA - STEVENS JULIE		GER - GERMANY
3	ITALY - CRUCITTI FRANCESCA - DE GREGORIO GABRIELLA - DOMINICI ROBERTA - PADOAN MARTINA		ITA - ITALY

U21 KATA TEAM MALE



EKF Junior, Cadet & U21 Championships 2026 - Lim..



ENTRIES BY WEIGHT CATEGORY

U21 Kata Team Male

As of 8 FEB 2026

Code	ID	Gender	Name	Seeding
AUT	AUT02673	M	WAGNER FELIX	
AUT	AUT02533	M	WU TIMON	
AUT	AUT02600	M	ZOECHLING FLORIAN	
CRO	CRO03281	M	BRAVARIC CILO DAMJAN	
CRO	CRO2641	M	FILES MARK	
CRO	CRO03015	M	HUIC DINO	
CRO	CRO03085	M	ZEINSKI IVAN	
ESP	ESP03013	M	GALAN LACON ALEJANDRO	
ESP	ESP03228	M	LOPEZ TOMAS IZAN	
ESP	ESP004093	M	LOPEZ VILLANUEVA JUAN MANUEL	
ESP	ESP02671	M	MARTIN MONTENEGRO IVAN	
FRA	FRA04093	M	COURTOIS TOM	
FRA	FRA02808	M	HOFFMANN LUCAS	
FRA	FRA03296	M	PELTIER TOM	
GER	GER03274	M	BECKER SEBASTIAN	
GER	GER02914	M	HADIZADEH JULIAN	
GER	GER03128	M	LUECK ANDREW LYLE	
ITA	ITA04766	M	DI RUBBA LUIGI	
ITA	ITA04187	M	MATACCHIONI LUIGI	
ITA	ITA03831	M	PAPPALARDO VINCENZO	
ITA	ITA04226	M	SERGI FRANCESCO	
SRB	SRB2536	M	BOSKOV ALEKSANDAR	
SRB	SRB2565	M	JAKOVLJEVIC VASILJE	
SRB	SRB03108	M	MILASINOVIC UROS	
SRB	SRB2682	M	VRZIC MISO	

U21 Kata Team Male

EKF Junior, Cadet & U21 Championships 2026 - Limassol, Spyros Kyprianou Athletic Center, Limassol, CYP

2026-02-07

Tatami
7 09:15

Pool
1/2

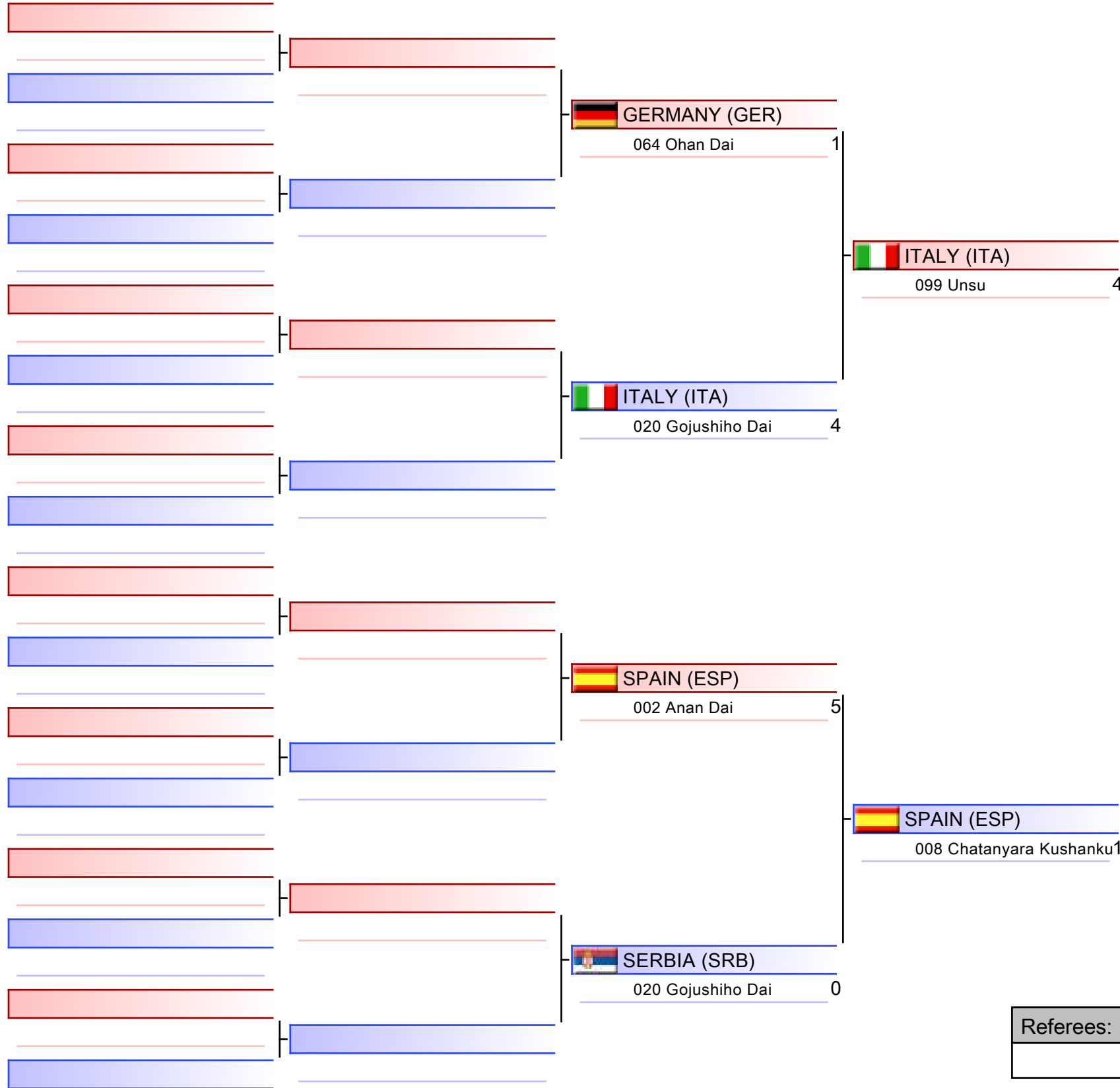

WKF
EUROPE

ITALY (ITA)

1. ITALY (ITA)
2. FRANCE (FRA)
3. AUSTRIA (AUT)
3. SPAIN (ESP)
5. GERMANY (GER)

Referees:			

U21 Kata Team Male

EKF Junior, Cadet & U21 Championships 2026 - Limassol, Spyros Kyprianou Athletic Center, Limassol, CYP

2026-02-07

Tatami
8 09:15

Pool
2/2

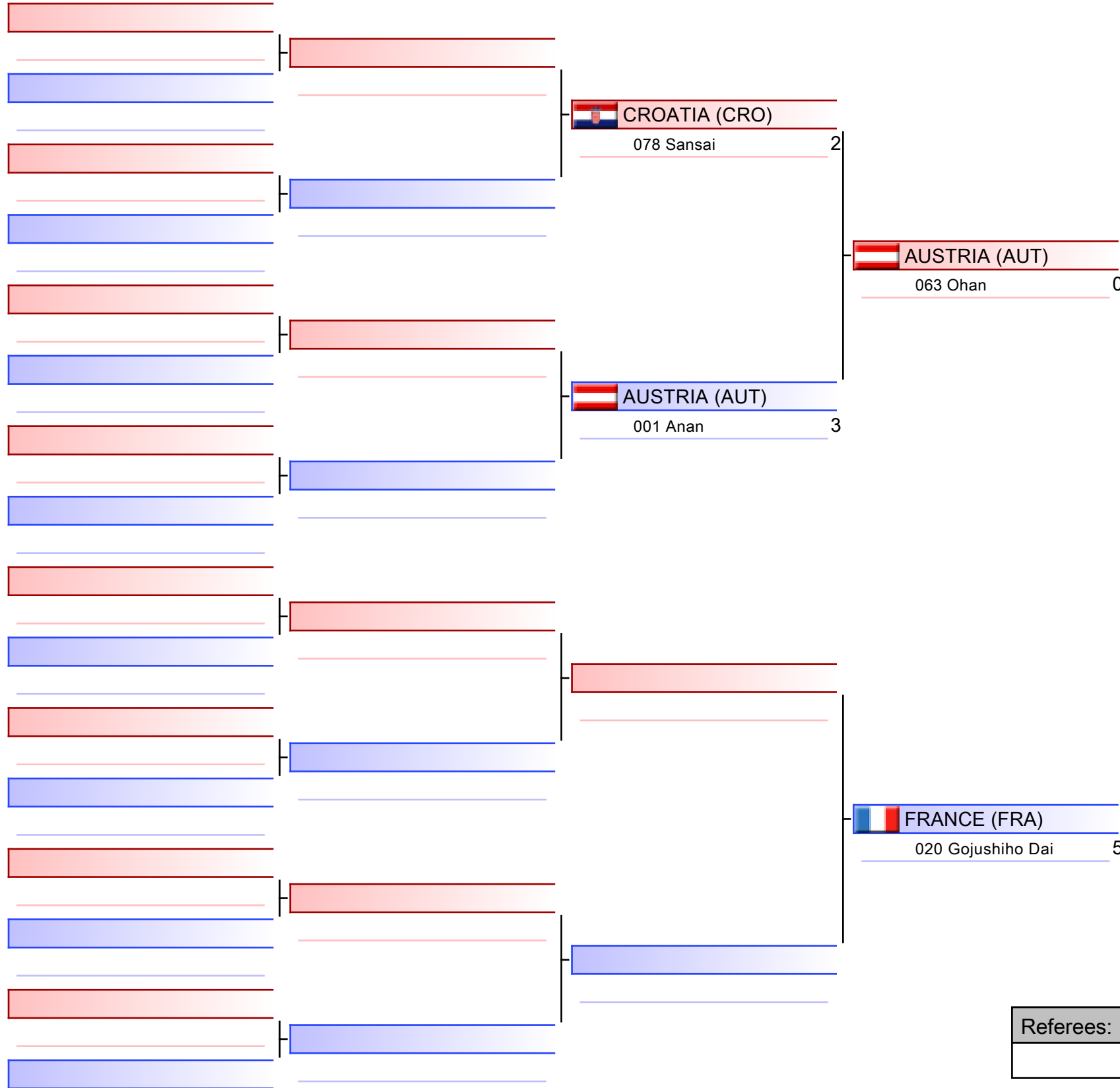

WKF

EUROPE

FRANCE (FRA)

1. ITALY (ITA)
2. FRANCE (FRA)
3. AUSTRIA (AUT)
3. SPAIN (ESP)
5. GERMANY (GER)

Referees:			

Pool winner-U21 Kata Team Male

EKF Junior, Cadet & U21 Championships 2026 - Limassol, Spyros Kyprianou Athletic Center, Limsassol, CYP

Tatami

Pool
1/1

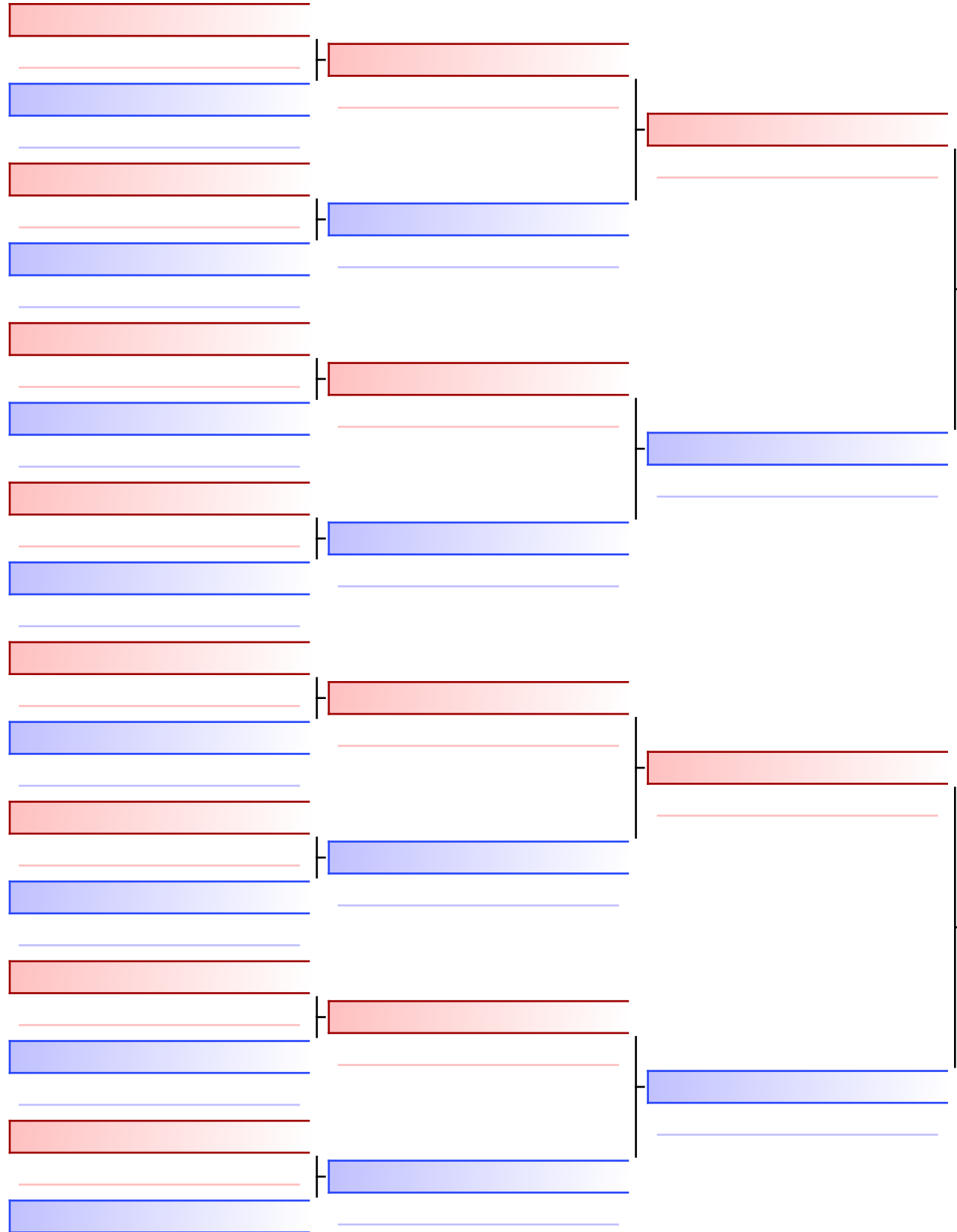

Final

 ITALY (ITA)
099 Unsu 4

 FRANCE (FRA)
099 Unsu 1

#1029 / 08.02

 ITALY (ITA)



WKF
EUROPE

1. ITALY (ITA)
2. FRANCE (FRA)
3. AUSTRIA (AUT)
3. SPAIN (ESP)
5. GERMANY (GER)

Referees:			

U21 Kata Team Male

EKF Junior, Cadet & U21 Championships 2026 - Limassol

2026-02-07

Tatami
8 09:45

Pool
1

(c)sportdata GmbH & Co KG 2000-2026 (2026-02-08 17:46) v 11.0.0 build 2 (2025-01-21 11:49 CET) License: SDIL TWG2025 (expire 2026-09-30)

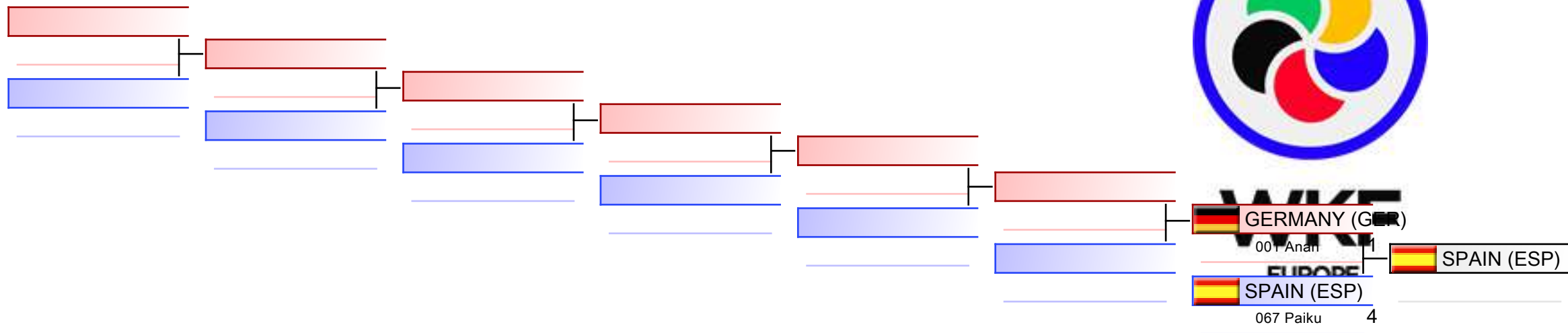

REPECHAGE: (1)

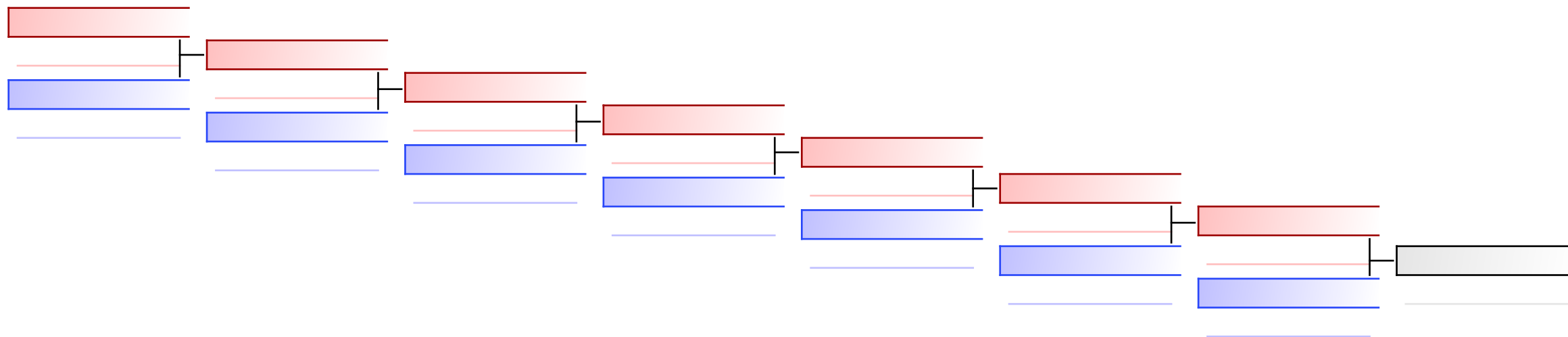

Referees:							
-----------	--	--	--	--	--	--	--

U21 Kata Team Male

EKF Junior, Cadet & U21 Championships 2026 - Limassol

2026-02-07

Tatami
8 09:35

Pool
2

(c)sportdata GmbH & Co KG 2000-2026 (2026-02-08 17:46) v 11.0.0 build 2 (2025-01-21 11:49 CET) License: SDIL TWG2025 (expire 2026-09-30)

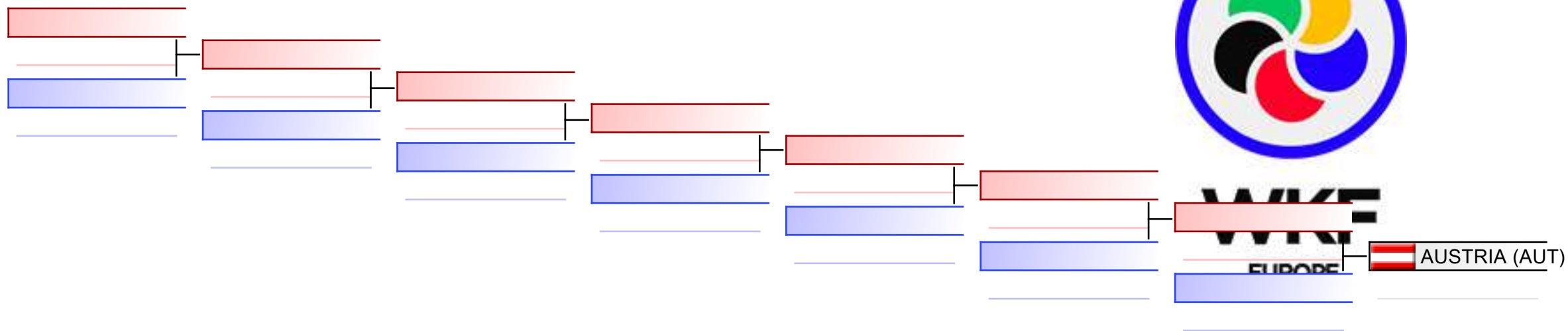

REPECHAGE: (2)

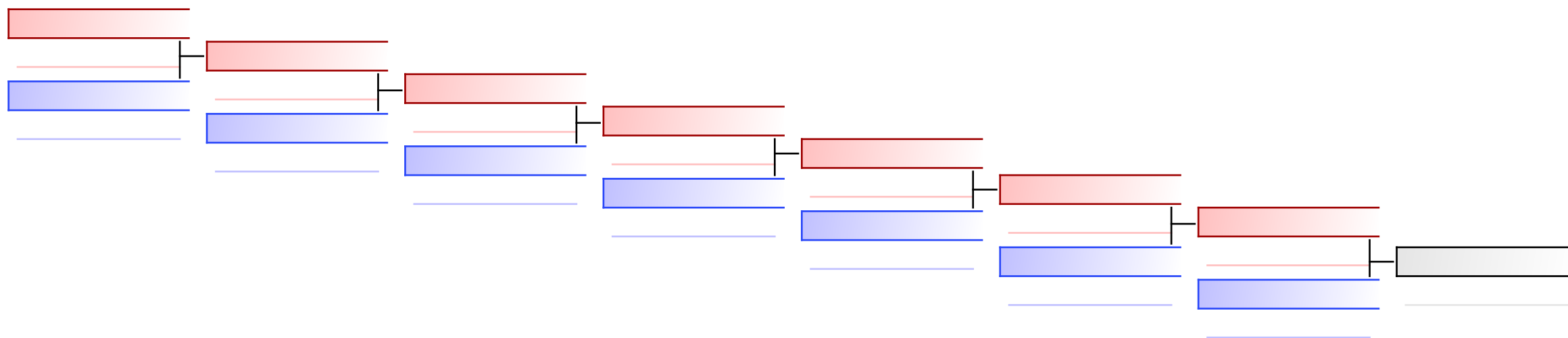





Referees:							
-----------	--	--	--	--	--	--	--



EKF Junior, Cadet & U21 Championships
2026 - Limassol - 2026-02-06



Official Results

U21 Kata Team Male				
1	ITALY - DI RUBBA LUIGI - MATA CCHIONI LUIGI - PAPPALARDO VINCENZO - SERGI FRANCESCO		ITA - ITALY	
2	FRANCE - COURTOIS TOM - HOFFMANN LUCAS - PELTIER TOM		FRA - FRANCE	
3	AUSTRIA - WU TIMON - ZOECHLING FLORIAN - WAGNER FELIX		AUT - AUSTRIA	
3	SPAIN - GALAN LACON ALEJANDRO - LOPEZ TOMAS IZAN - LOPEZ VILLANUEVA JUAN MANUEL - MARTIN MONTENEGRO IVAN		ESP - SPAIN	
5	GERMANY - BECKER SEBASTIAN - HADIZADEH JULIAN - LUECK ANDREW LYLE		GER - GERMANY	

U21 KUMITE FEMALE -50 KG



EKF Junior, Cadet & U21 Championships 2026 - Lim..



ENTRIES BY WEIGHT CATEGORY

U21 Kumite Female -50 kg

As of 8 FEB 2026

Code	ID	Gender	Name	Seeding
AZE	AZE02546	F	JABRAYILOVA FATIMA	
BIH	BIH2640	F	MESKOVIC AJLA	
BUL	BUL2210	F	TSANEVA TEODORA	1
CRO	CRO2883	F	IVANCIC DOROTEA	
CZE	CZE02434	F	MALA DANIELA	
DEN	DEN002996	F	SOENDERGAARD SOFIA BATH	
ESP	ESP02675	F	VIZUETE OLIVENZA MIREIA	4
FRA	FRA03436	F	COCHARD LOLA	
GEO	GEO02669	F	VASADZE MARIAMI	
GER	SD48610	F	WOLF ALEXANDRA	
GRE	GRE02642	F	PAPPA CHRISTINA TRIADA	
IRL	IRL02910	F	MULHERN LUCY	
ITA	ITA04268	F	LEGITTIMO LUDOVICA	2
LTU	LTU02348	F	DRIUCIKAITE ROBERTA	
LUX	LUX02191	F	MOENS ALIX	
MKD	MKD2406	F	MISHOVSKA MIHAELA	
NED	NED02464	F	YALCIN SAMINA	
POL	POL3143	F	WASILEWSKA ZUZANNA	
POR	POR003508	F	MELEIRO BEATRIZ	
ROU	ROU2569	F	NASTAS PATRICIA	3
SRB	SRB2486	F	COSO ANJA	
SUI	SUI02602	F	WYSSBROD SELIN	
SVK	SVK02627	F	MALA LILIANA	
SWE	SWE02686	F	NYMAN AGNES	
UKR	UKR02873	F	KHOMENKO DARIA	
WKF-1	WKF105405	F	DAVYDOVA VICTORIA	
WKF-2	BLR02396	F	MARKAVA ULYANA	

U21 Kumite Female -50 kg

EKF Junior, Cadet & U21 Championships 2026 - Limassol, Spyros Kyprianou Athletic Center, Limassol, CYP

2026-02-07

Tatami
5 13:20

Pool
1/4

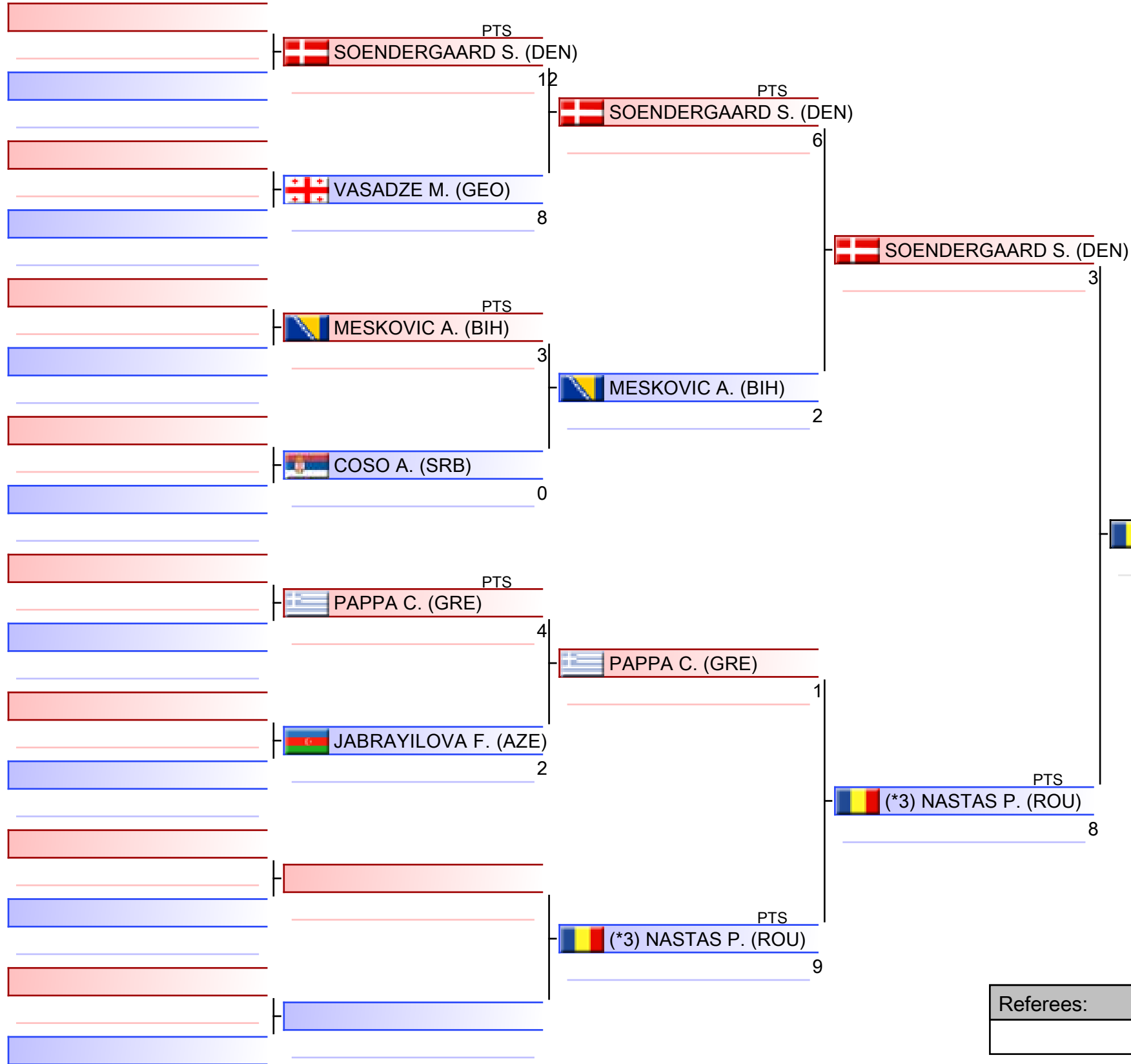

1. MARKAVA ULYANA (WKF-2)
2. LEGITTIMO LUDOVICA (ITA)
3. DAVYDOVA VICTORIA (WKF-1)
3. NYMAN AGNES (SWE)
5. NASTAS PATRICIA (ROU)
5. VIZUETE OLIVENZA MIREIA (ESP)
7. MISHOVSKA MIHAELA (MKD)
7. COCHARD LOLA (FRA)

*Seeded

Referees:			

U21 Kumite Female -50 kg

EKF Junior, Cadet & U21 Championships 2026 - Limassol, Spyros Kyprianou Athletic Center, Limassol, CYP

2026-02-07

Tatami
5 13:55

Pool
2/4

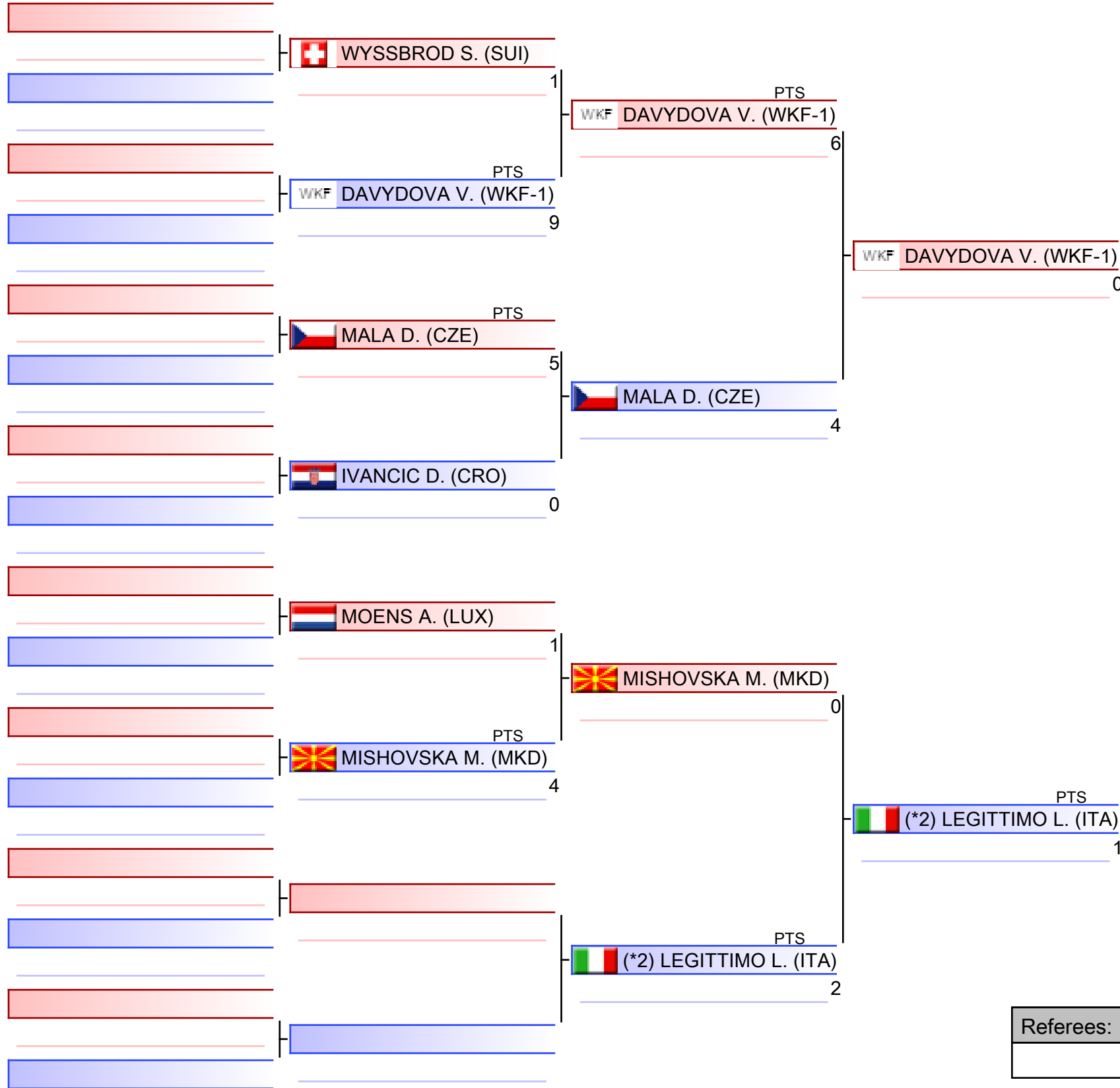

(*2) LEGITTIMO L. (ITA)

1. MARKAVA ULYANA (WKF-2)
2. LEGITTIMO LUDOVICA (ITA)
3. DAVYDOVA VICTORIA (WKF-1)
3. NYMAN AGNES (SWE)
5. NASTAS PATRICIA (ROU)
5. VIZUETE OLIVENZA MIREIA (ESP)
7. MISHOVSKA MIHAELA (MKD)
7. COCHARD LOLA (FRA)

*Seeded

Referees:			

U21 Kumite Female -50 kg

EKF Junior, Cadet & U21 Championships 2026 - Limassol, Spyros Kyprianou Athletic Center, Limassol, CYP

2026-02-07

Tatami
6 13:15

Pool
3/4



WKF
EUROPE

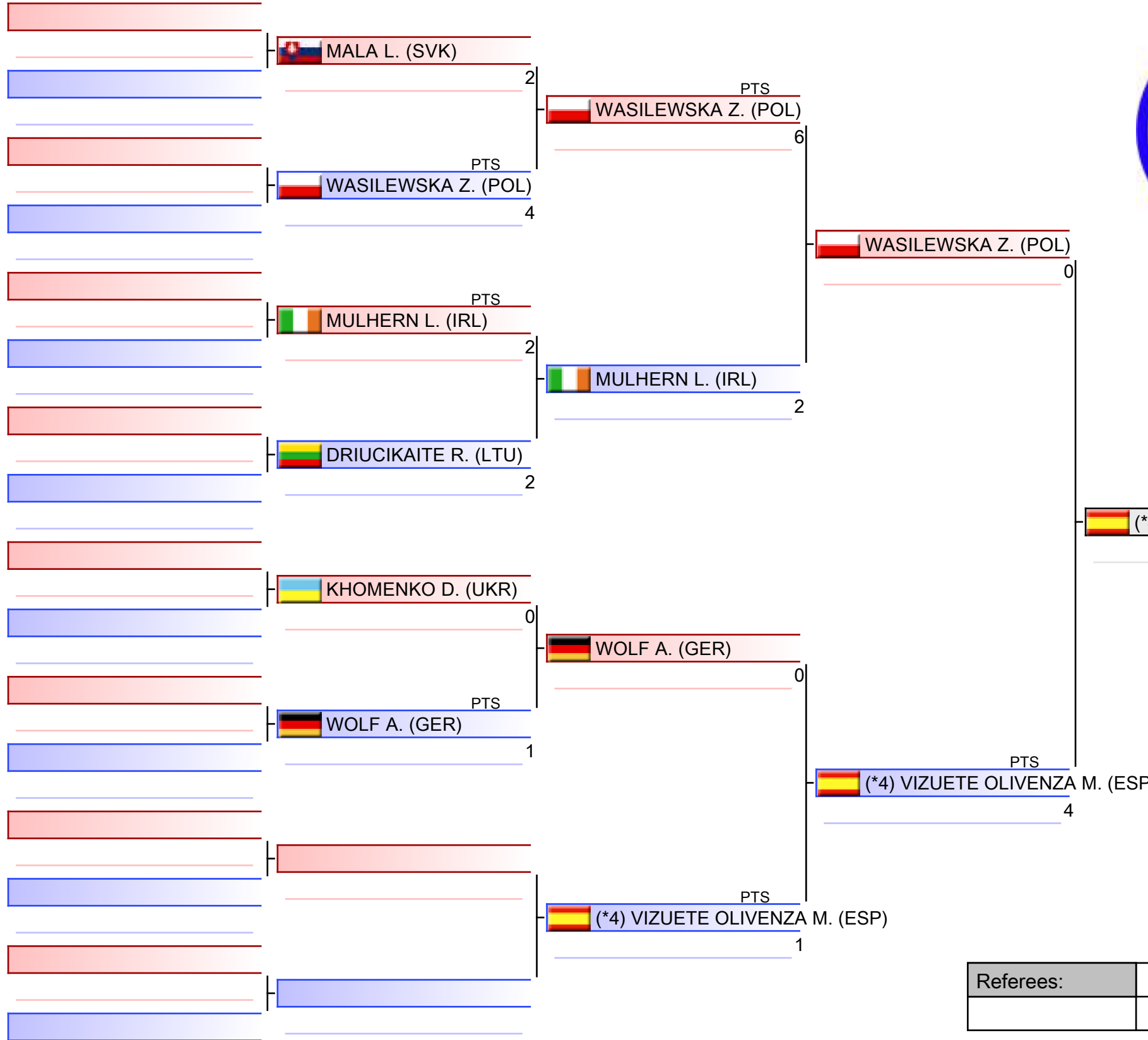

(*4) VIZUETE OLIVENZA M. (ESP)

1. MARKAVA ULYANA (WKF-2)
2. LEGITTIMO LUDOVICA (ITA)
3. DAVYDOVA VICTORIA (WKF-1)
3. NYMAN AGNES (SWE)
5. NASTAS PATRICIA (ROU)
5. VIZUETE OLIVENZA MIREIA (ESP)
7. MISHOVSKA MIHAELA (MKD)
7. COCHARD LOLA (FRA)

*Seeded

Referees:			

U21 Kumite Female -50 kg

EKF Junior, Cadet & U21 Championships 2026 - Limassol, Spyros Kyprianou Athletic Center, Limassol, CYP

2026-02-07

Tatami
6 13:50

Pool
4/4



WKF
EUROPE

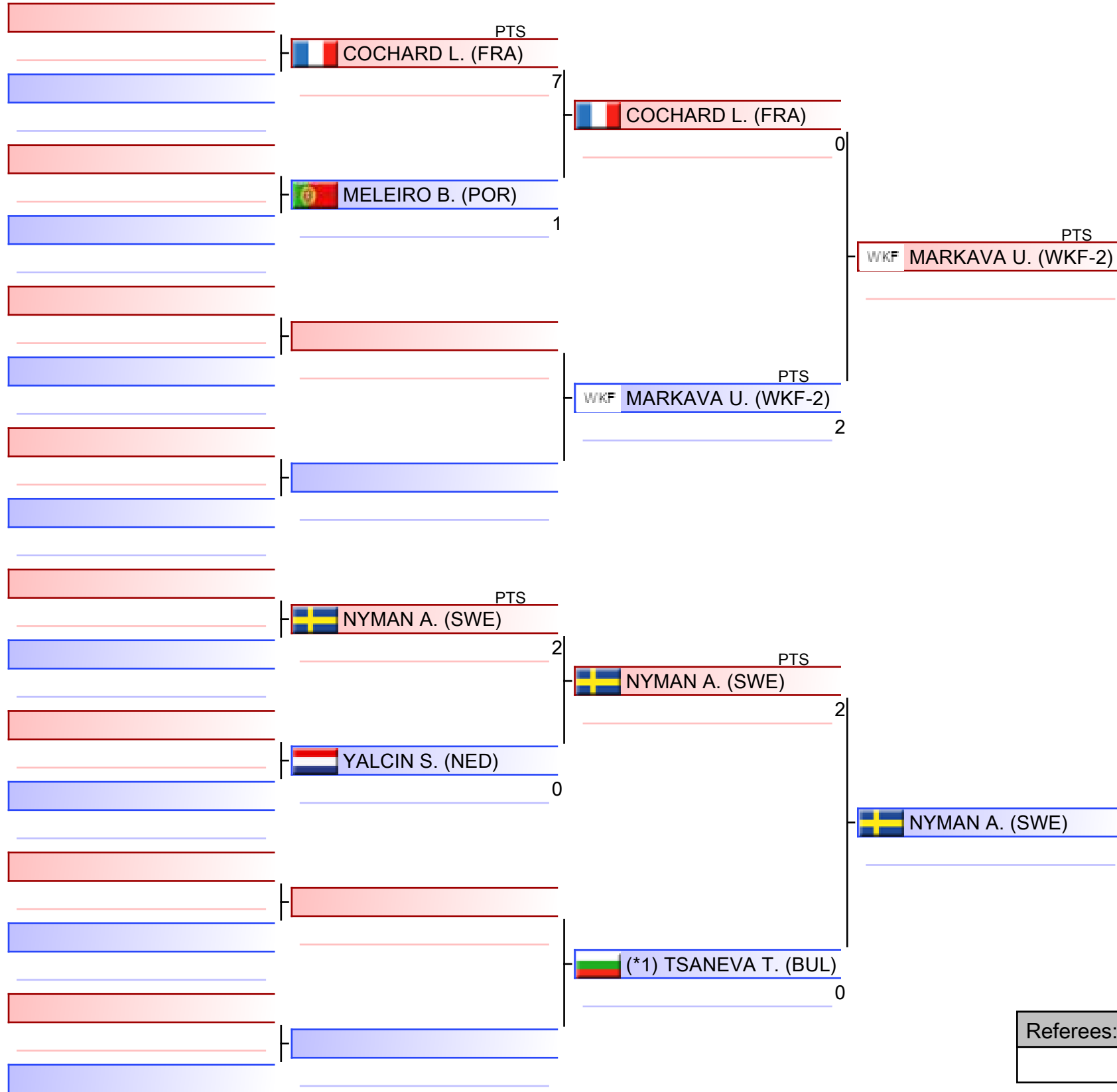

1. MARKAVA ULYANA (WKF-2)
2. LEGITTIMO LUDOVICA (ITA)
3. DAVYDOVA VICTORIA (WKF-1)
3. NYMAN AGNES (SWE)
5. NASTAS PATRICIA (ROU)
5. VIZUETE OLIVENZA MIREIA (ESP)
7. MISHOVSKA MIHAELA (MKD)
7. COCHARD LOLA (FRA)

*Seeded

Referees:			

Pool winner-U21 Kumite Female -50 kg

EKF Junior, Cadet & U21 Championships 2026 - Limassol, Spyros Kyprianou Athletic Center, Limsassol, CYP

2026-02-07

Tatami
5 14:30

Pool
1/1

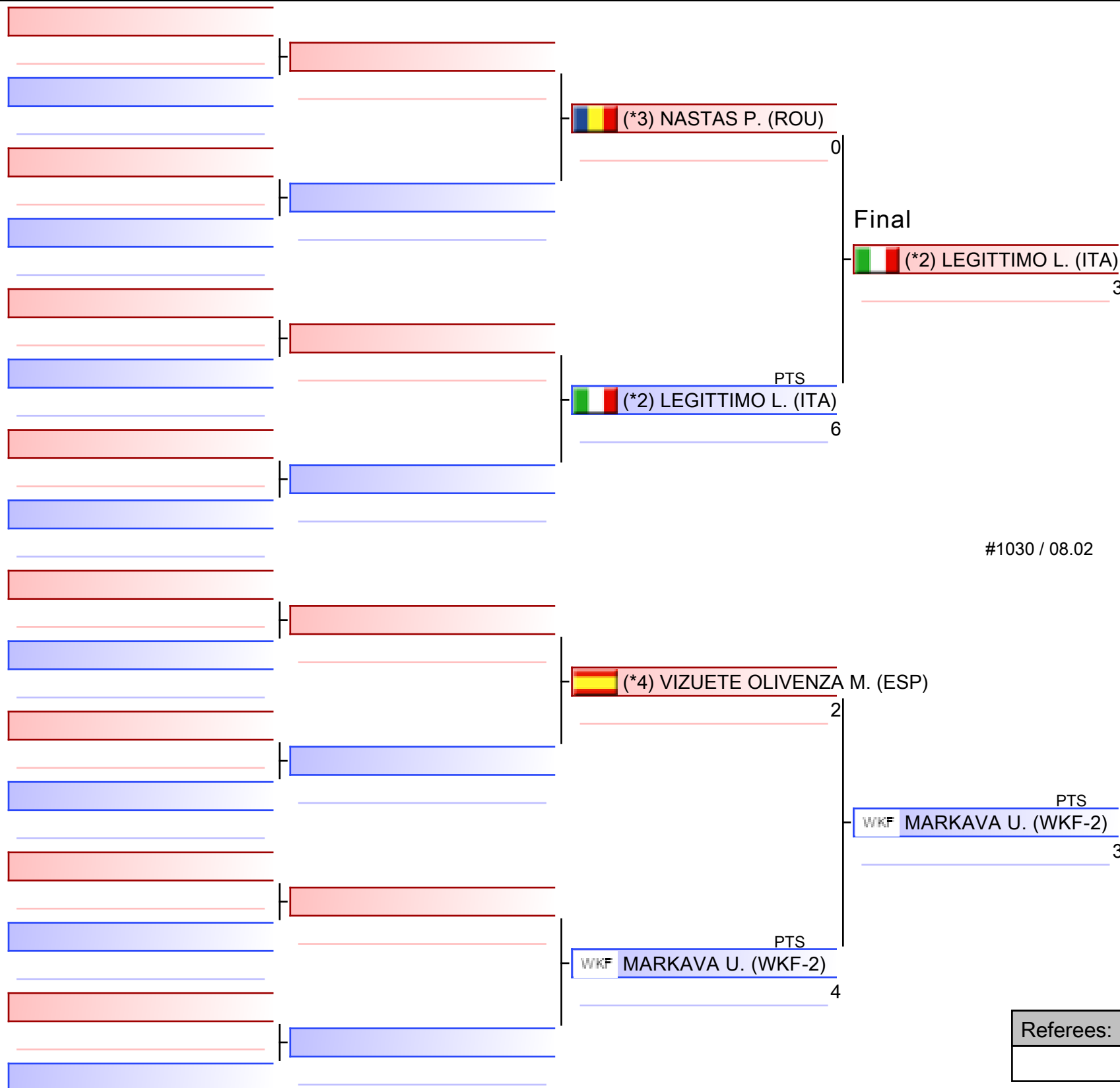

WKF
EUROPE

#1030 / 08.02

WKF MARKAVA U. (WKF-2)

1. MARKAVA ULYANA (WKF-2)
2. LEGITTIMO LUDOVICA (ITA)
3. DAVYDOVA VICTORIA (WKF-1)
3. NYMAN AGNES (SWE)
5. NASTAS PATRICIA (ROU)
5. VIZUETE OLIVENZA MIREIA (ESP)
7. MISHOVSKA MIHAELA (MKD)
7. COCHARD LOLA (FRA)

*Seeded

Referees:			

U21 Kumite Female -50 kg

EKF Junior, Cadet & U21 Championships 2026 - Limassol

2026-02-07

Tatami

1 17:50

Pool

1,2,3,4

(c)sportdata GmbH & Co KG 2000-2026 (2026-02-08 17:46) v 11.0.0 build 2 (2025-01-21 11:49 CET) License: SDIL TWG2025 (expire 2026-09-30)



#131 / 07.02

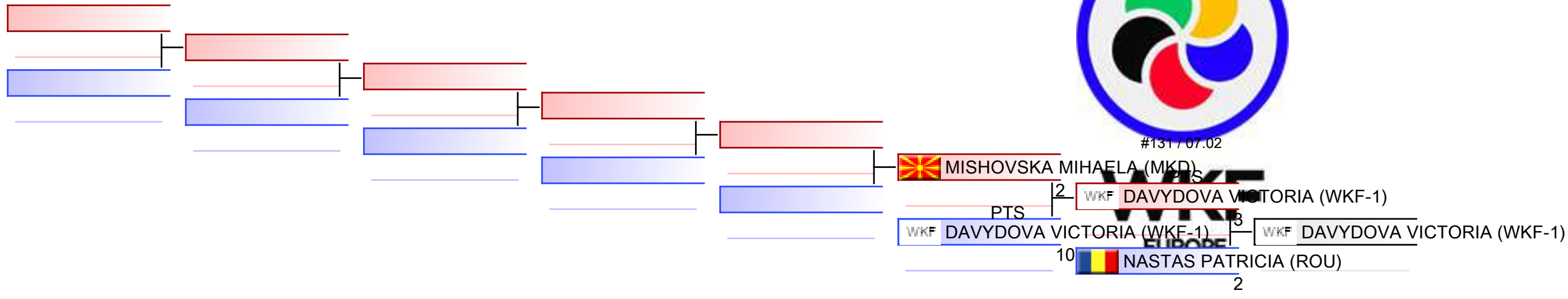

REPECHAGE: (1,2,3,4)

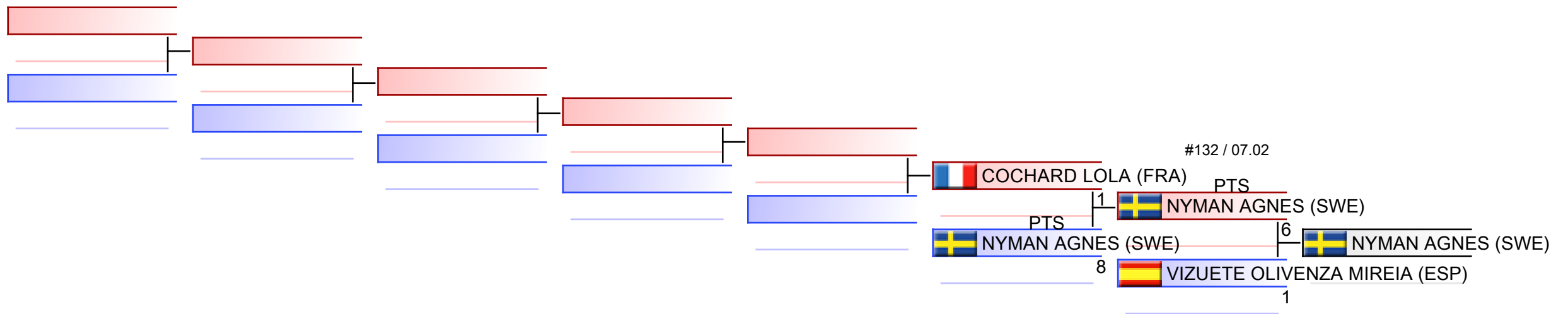







Referees:							
-----------	--	--	--	--	--	--	--



EKF Junior, Cadet & U21 Championships
2026 - Limassol - 2026-02-06



Official Results

U21 Kumite Female -50 kg			
1	MARKAVA ULYANA	WKF	WKF-2 - WKF-2
2	LEGITTIMO LUDOVICA		ITA - ITALY
3	DAVYDOVA VICTORIA	WKF	WKF-1 - WKF-1
3	NYMAN AGNES		SWE - SWEDEN
5	NASTAS PATRICIA		ROU - ROMANIA
5	VIZUETE OLIVENZA MIREIA		ESP - SPAIN
7	MISHOVSKA MIHAELA		MKD - NORTH MACEDONIA
7	COCHARD LOLA		FRA - FRANCE

U21 KUMITE FEMALE -55 KG



EKF Junior, Cadet & U21 Championships 2026 - Lim..



ENTRIES BY WEIGHT CATEGORY

U21 Kumite Female -55 kg

As of 8 FEB 2026

Code	ID	Gender	Name	Seeding
BIH	BIH2907	F	MEHANIJA HENA	
CRO	CRO2968	F	PRGA PATRICIJA	4
CYP	CYP02730	F	KYPRIANOU MARIA	
CZE	CZE02268	F	HRDLICKOVA LUCY	
DEN	DEN003042	F	JOERGENSEN KARLA ROSGAARD	
ENG	ENG003393	F	CARRUTHERS ARABELLA	
ESP	ESP004412	F	LOPEZ ARANDA EVA	
EST	EST02567	F	ANNION LISETTE	
FRA	FRA03633	F	ABDESSELEM SYLIA	
GER	GER02725	F	OTT SIDNEY-MICHELLE	
GRE	GRE03223	F	ZAMANTZA MARIA-ANTONIA	
HUN	HUN02787	F	MOLNAR VIRAG	
ITA	ITA04767	F	ORTU REBECCA	
LTU	LTU02310	F	LIUTKEVICIUTE MIGLE	
LUX	LUX02426	F	JADIN LANA	
MKD	MKD2582	F	PANCHEVA MILA	
MLT	MLT02199	F	MIZZI EMMA	
MNE	MNE2293	F	BACKOVIC HELENA	3
NED	NED02800	F	VOORDUIN ALYSSIA	
NOR	NOR02444	F	SJURSEN ALVA ALEXANDRA SIVERTSEN	
POL	POL08881	F	DRONCHANKA KSENIYA	2
POR	POR02764	F	ECA GUIMARAES MARTA PIMENTA	
ROU	ROU03098	F	ANDREI LORELLEY ANISIA	
SLO	SLO02712	F	LEBEN TINKARA	
SUI	SUI02566	F	STREIT KIM LARA	
SVK	SVK02345	F	KVASNICOVA NINA	1
UKR	UKR003729	F	KOSHEL SOFIYA	
WAL	WAL02416	F	JONES ELEANOR	
WKF-1	AIN-1006667	F	ZVIAGINTSEVA OLGA	

U21 Kumite Female -55 kg

EKF Junior, Cadet & U21 Championships 2026 - Limassol, Spyros Kyprianou Athletic Center, Limassol, CYP

2026-02-07

Tatami
7 13:30

Pool
1/4



WKF
EUROPE

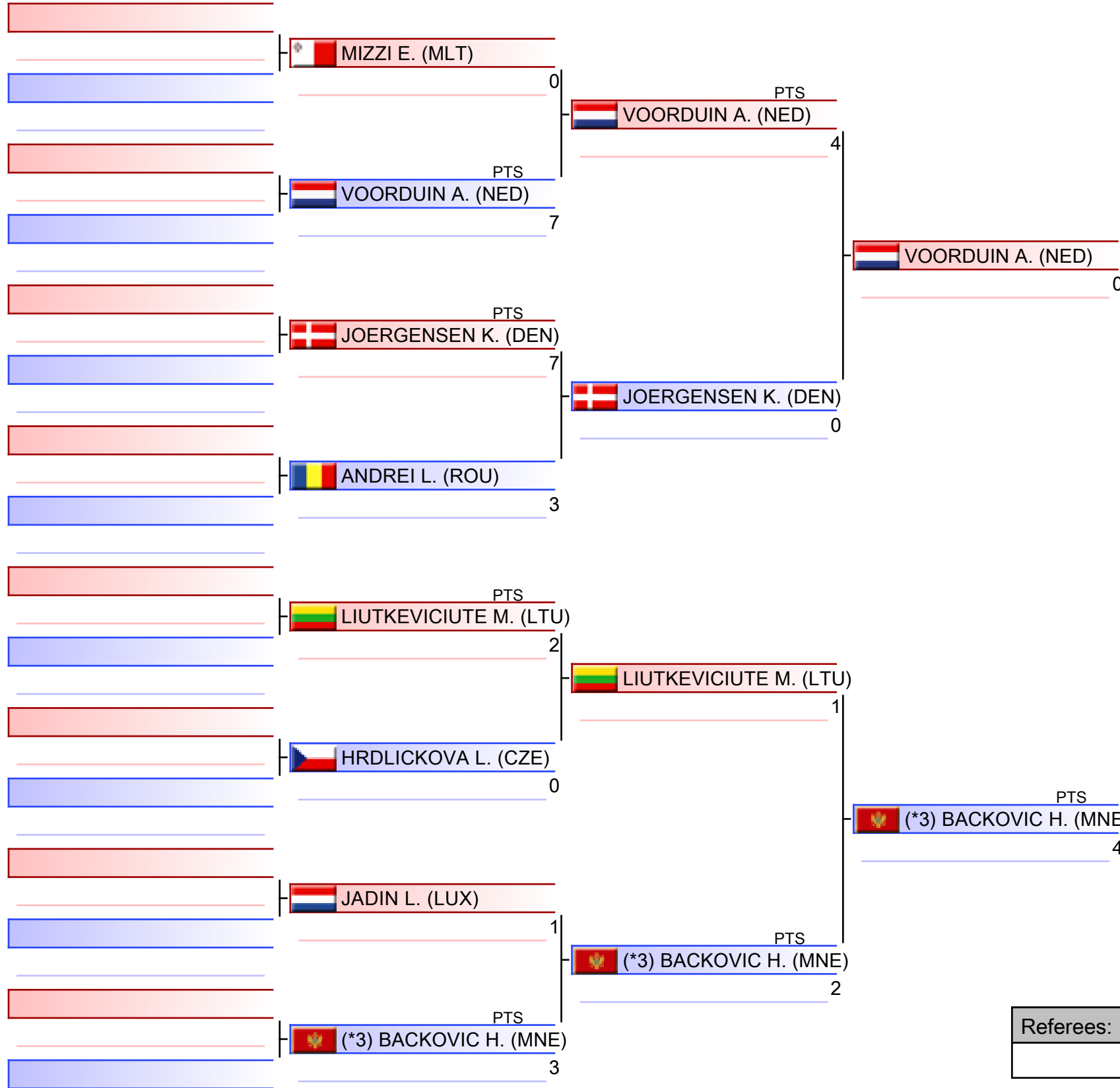

(*3) BACKOVIC H. (MNE)

1. KVASNICOVA NINA (SVK)
2. BACKOVIC HELENA (MNE)
3. LIUTKEVICIUTE MIGLE (LTU)
3. ABDESSELEM SYLIA (FRA)
5. MEHANIJA HENA (BIH)
5. ZVIAGINTSEVA OLGA (WKF-1)
7. VOORDUIN ALYSSIA (NED)
7. PANCHEVA MILA (MKD)

*Seeded

Referees:			

U21 Kumite Female -55 kg

EKF Junior, Cadet & U21 Championships 2026 - Limassol, Spyros Kyprianou Athletic Center, Limassol, CYP

2026-02-07

Tatami
7 14:15

Pool
2/4



WKF
EUROPE

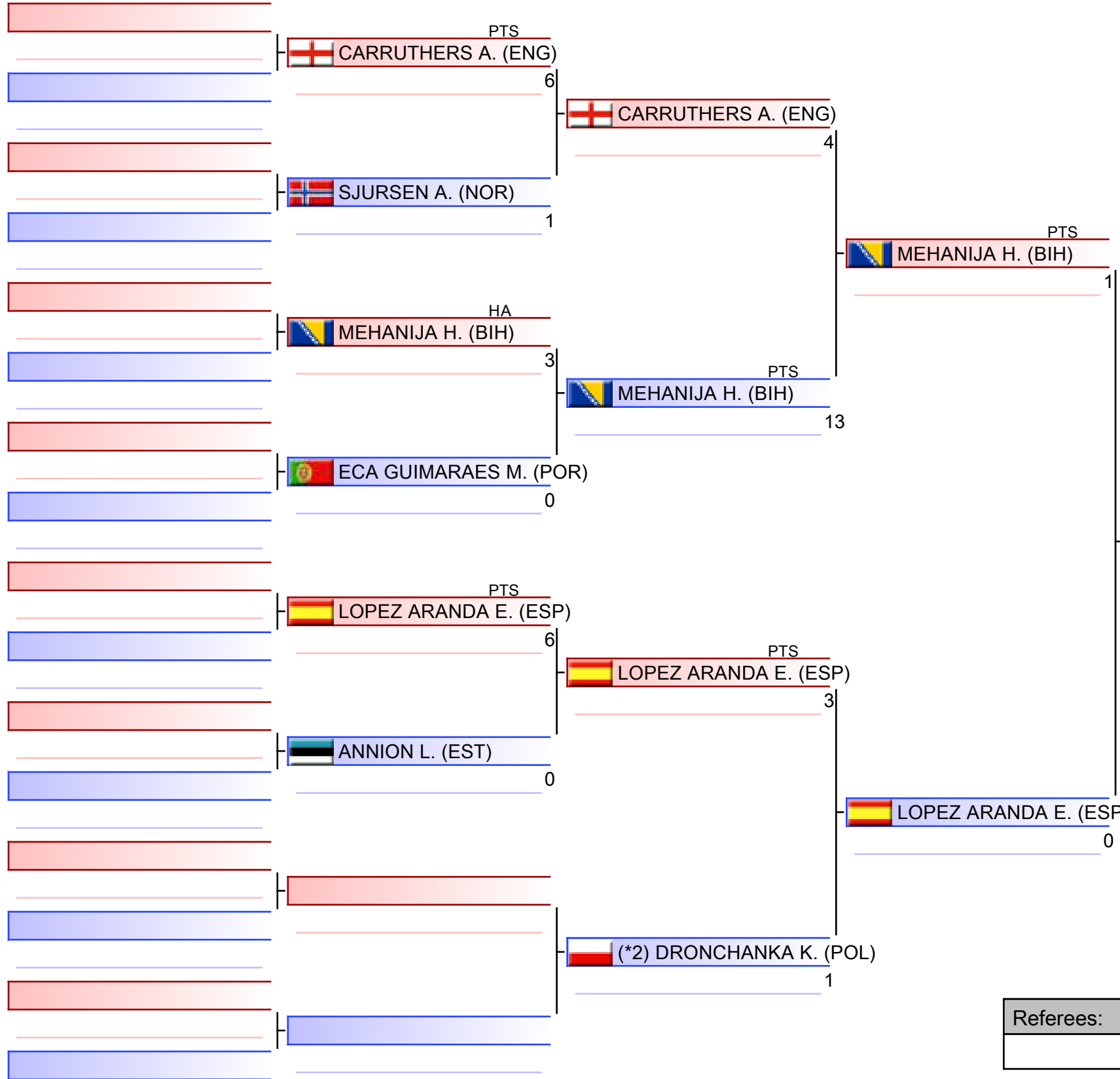

1. KVASNICOVA NINA (SVK)
2. BACKOVIC HELENA (MNE)
3. LIUTKEVICIUTE MIGLE (LTU)
3. ABDESSELEM SYLIA (FRA)
5. MEHANIJA HENA (BIH)
5. ZVIAGINTSEVA OLGA (WKF-1)
7. VOORDUIN ALYSSIA (NED)
7. PANCHEVA MILA (MKD)

*Seeded

Referees:			

U21 Kumite Female -55 kg

EKF Junior, Cadet & U21 Championships 2026 - Limassol, Spyros Kyprianou Athletic Center, Limassol, CYP

2026-02-07

Tatami
8 13:20

Pool
3/4



WKF
EUROPE

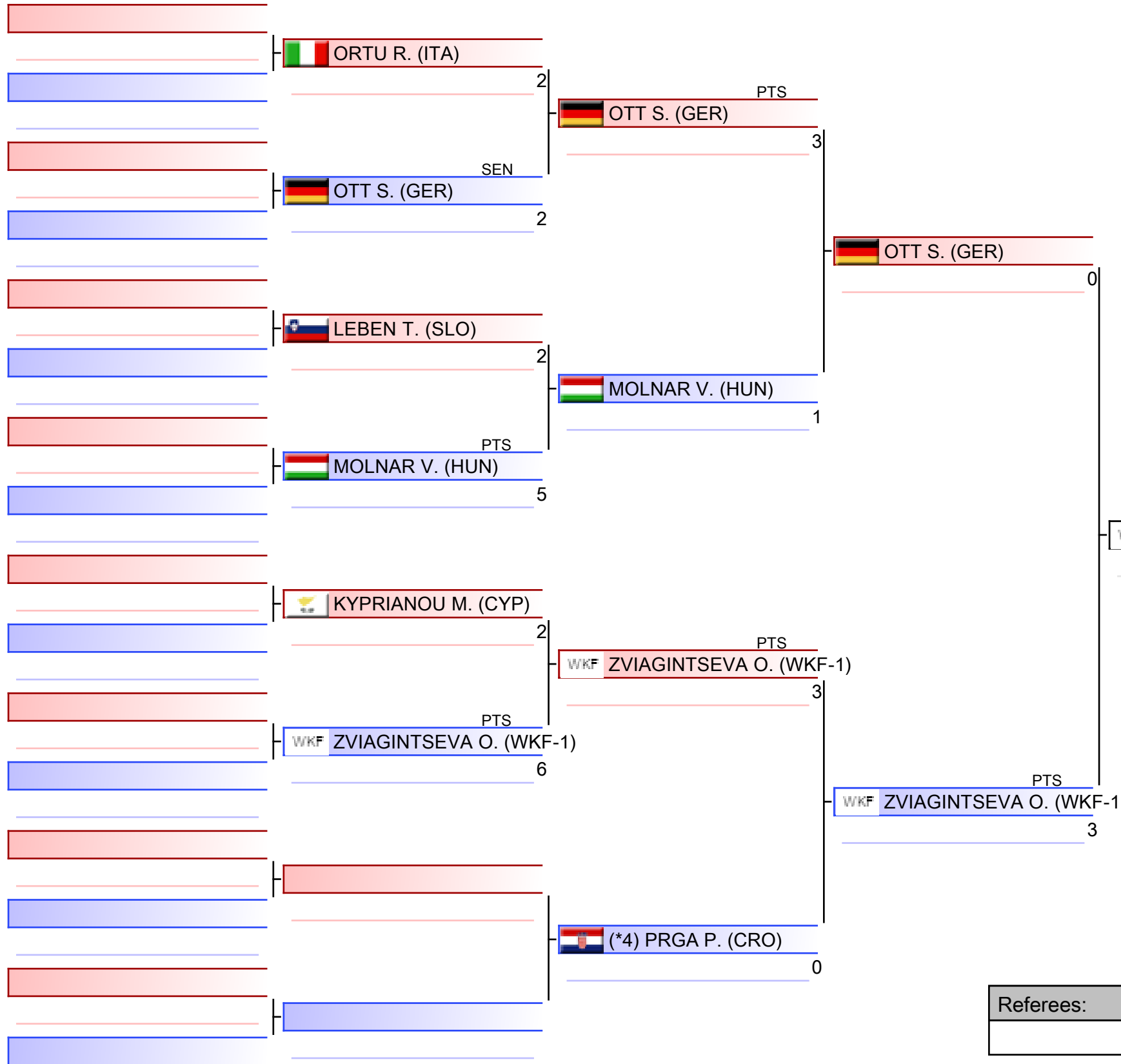

WKF ZVIAGINTSEVA O. (WKF-1)

1. KVASNICOVA NINA (SVK)
2. BACKOVIC HELENA (MNE)
3. LIUTKEVICIUTE MIGLE (LTU)
3. ABDESSELEM SYLIA (FRA)
5. MEHANIJA HENA (BIH)
5. ZVIAGINTSEVA OLGA (WKF-1)
7. VOORDUIN ALYSSIA (NED)
7. PANCHEVA MILA (MKD)

*Seeded

Referees:			

U21 Kumite Female -55 kg

EKF Junior, Cadet & U21 Championships 2026 - Limassol, Spyros Kyprianou Athletic Center, Limassol, CYP

2026-02-07

Tatami
8 13:55

Pool
4/4



WKF
EUROPE

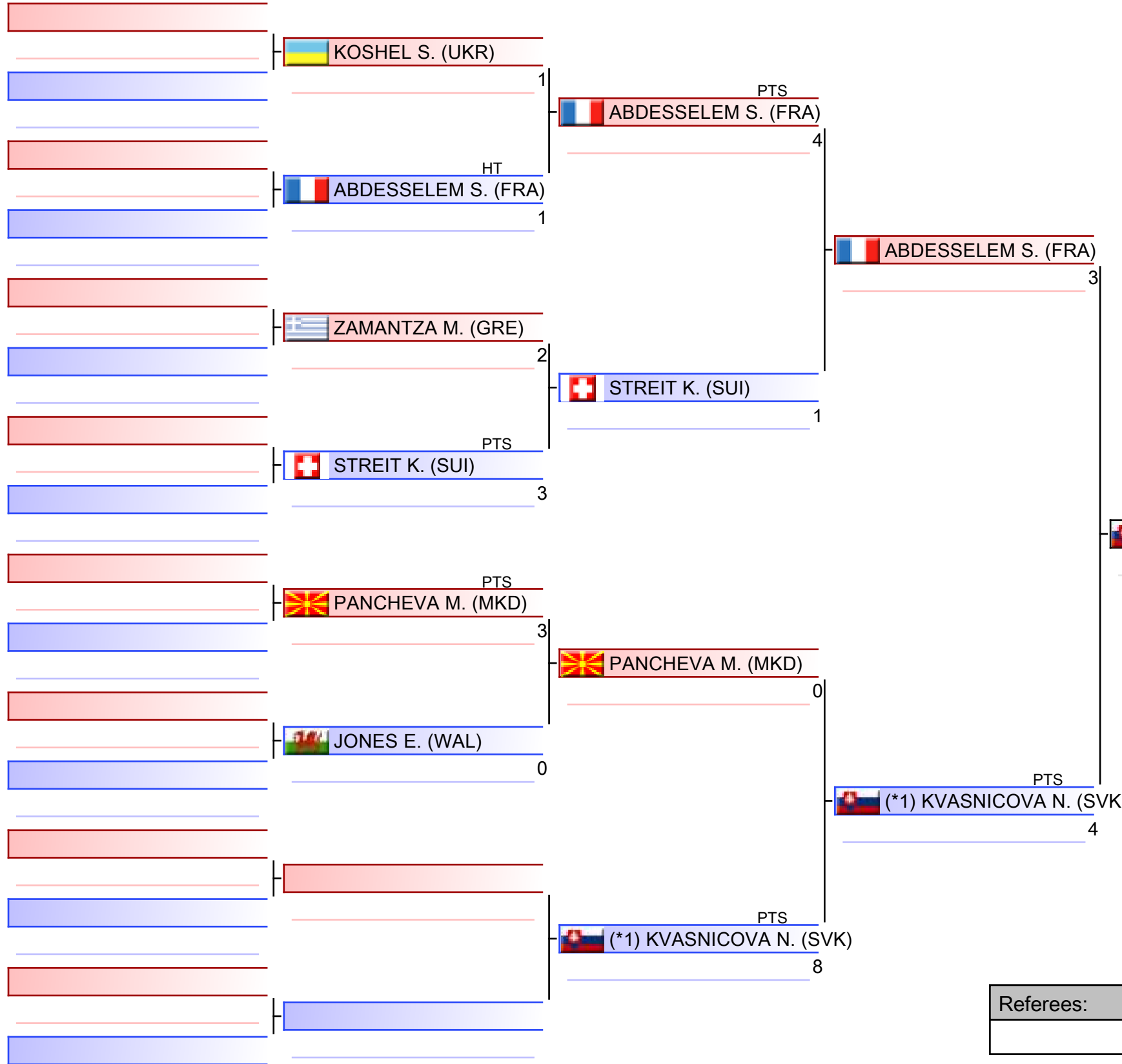

(*1) KVASNICOVA N. (SVK)

1. KVASNICOVA NINA (SVK)
2. BACKOVIC HELENA (MNE)
3. LIUTKEVICIUTE MIGLE (LTU)
3. ABDESSELEM SYLIA (FRA)
5. MEHANIJA HENA (BIH)
5. ZVIAGINTSEVA OLGA (WKF-1)
7. VOORDUIN ALYSSIA (NED)
7. PANCHEVA MILA (MKD)

*Seeded

Referees:			

Pool winner-U21 Kumite Female -55 kg

EKF Junior, Cadet & U21 Championships 2026 - Limassol, Spyros Kyprianou Athletic Center, Limsassol, CYP

2026-02-07

Tatami
7 14:50

Pool
1/1



WKF
EUROPE

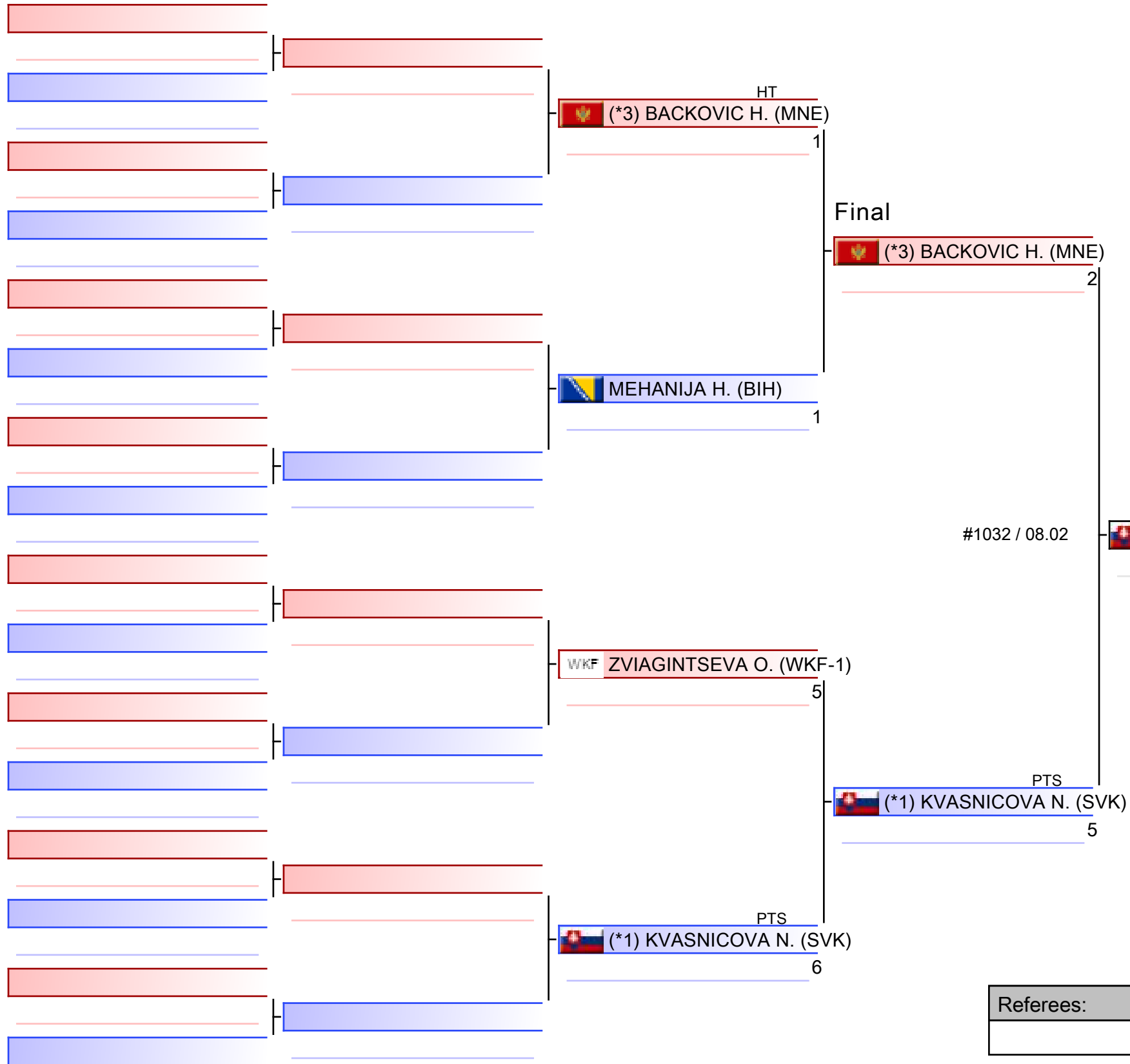

1. KVASNICOVA NINA (SVK)
2. BACKOVIC HELENA (MNE)
3. LIUTKEVICIUTE MIGLE (LTU)
3. ABDESSELEM SYLIA (FRA)
5. MEHANIJA HENA (BIH)
5. ZVIAGINTSEVA OLGA (WKF-1)
7. VOORDUIN ALYSSIA (NED)
7. PANCHEVA MILA (MKD)

*Seeded

Referees:			

U21 Kumite Female -55 kg

EKF Junior, Cadet & U21 Championships 2026 - Limassol

2026-02-07

Tatami
4 17:55

Pool
1,2,3,4

(c)sportdata GmbH & Co KG 2000-2026 (2026-02-08 17:46) v 11.0.0 build 2 (2025-01-21 11:49 CET) License: SDIL TWG2025 (expire 2026-09-30)

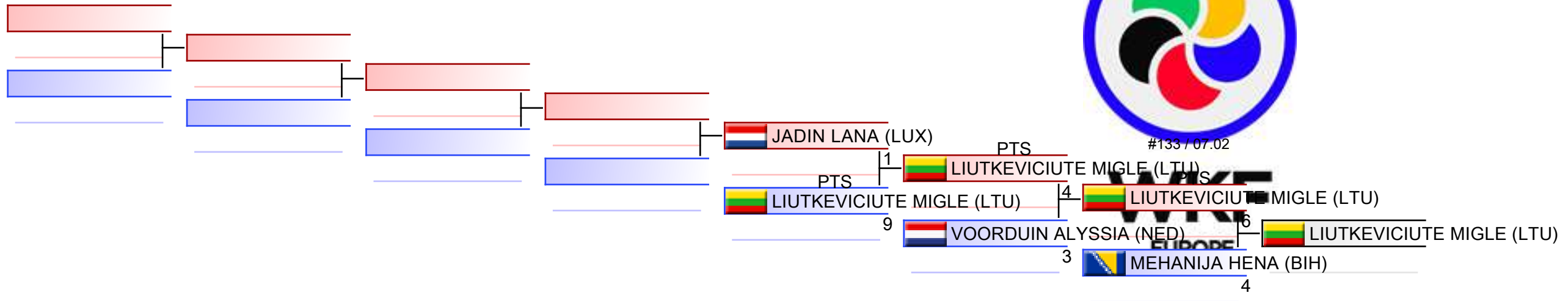

REPECHAGE: (1,2,3,4)

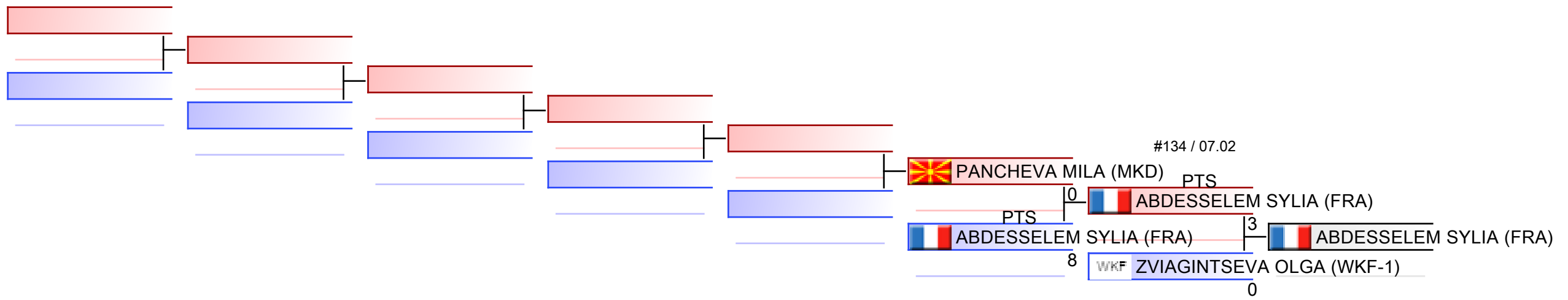

Referees:							
-----------	--	--	--	--	--	--	--



EKF Junior, Cadet & U21 Championships
2026 - Limassol - 2026-02-06



Official Results

U21 Kumite Female -55 kg			
1	KVASNICOVA NINA		SVK - SLOVAKIA
2	BACKOVIC HELENA		MNE - MONTENEGRO
3	LIUTKEVICIUTE MIGLE		LTU - LITHUANIA
3	ABDESSELEM SYLIA		FRA - FRANCE
5	MEHANIJA HENA		BIH - BOSNIA AND HERZEGOVINA
5	ZVIAGINTSEVA OLGA		WKF-1 - WKF-1
7	VOORDUIN ALYSSIA		NED - NETHERLANDS
7	PANCHEVA MILA		MKD - NORTH MACEDONIA
9	JADIN LANA		LUX - LUXEMBOURG

U21 KUMITE FEMALE -61 KG



EKF Junior, Cadet & U21 Championships 2026 - Lim..



ENTRIES BY WEIGHT CATEGORY

U21 Kumite Female -61 kg

As of 8 FEB 2026

Code	ID	Gender	Name	Seeding
AUT	AUT02677	F	SKRIJELJ SARA	
AZE	AZE02878	F	ORUJOVA GULAY	
BEL	BEL02332	F	BOUGRINE AMEL	2
BIH	BIH004856	F	JAKSIC ALEKSANDRA	
BUL	BUL02757	F	STOYANOVA YOANNA	
CRO	CRO03132	F	KLARIC KORINA	
CZE	CZE02424	F	PRIGLOVA MARIE	
DEN	DEN02569	F	BOHNHOF KARLA	
ENG	ENG02890	F	BLAKE TAHLIA	
ESP	ESP03038	F	OTERO LUENGO EVA	4
FRA	FRA03459	F	ARZUMIAN MONICA	
GER	GER03258	F	SEMENENKO ANASTASIIA	1
GRE	GRE02320	F	XENOU LYDIA LAMPRINI	
HUN	HUN003518	F	TAMASI ZSOFIA BOGLARKA	
ITA	ITA03806	F	MARTURANO IRENE	
LAT	LAT02561	F	GIRVICA BEATA	
MKD	MKD2554	F	MICOVSKA JOVANA	
MNE	MNE2289	F	BORICIC NADJA	
POL	POL06896	F	LEWANDOWSKA KATARZYNA	
ROU	ROU02844	F	LUCHESCU ELISABETA	
SRB	SRB2340	F	FILIPOV NEVENA	
SUI	SUI004973	F	BUERKI DANICHA	
SVK	SVK02426	F	VACZY ANNA	3
UKR	UKR03090	F	MAKARENKO VIOLETTA	
WKF-1	RUS04485	F	BASANGOVA ALTANA	

U21 Kumite Female -61 kg

EKF Junior, Cadet & U21 Championships 2026 - Limassol, Spyros Kyprianou Athletic Center, Limassol, CYP

2026-02-07

Tatami
7 14:55

Pool
1/4



WKF
EUROPE

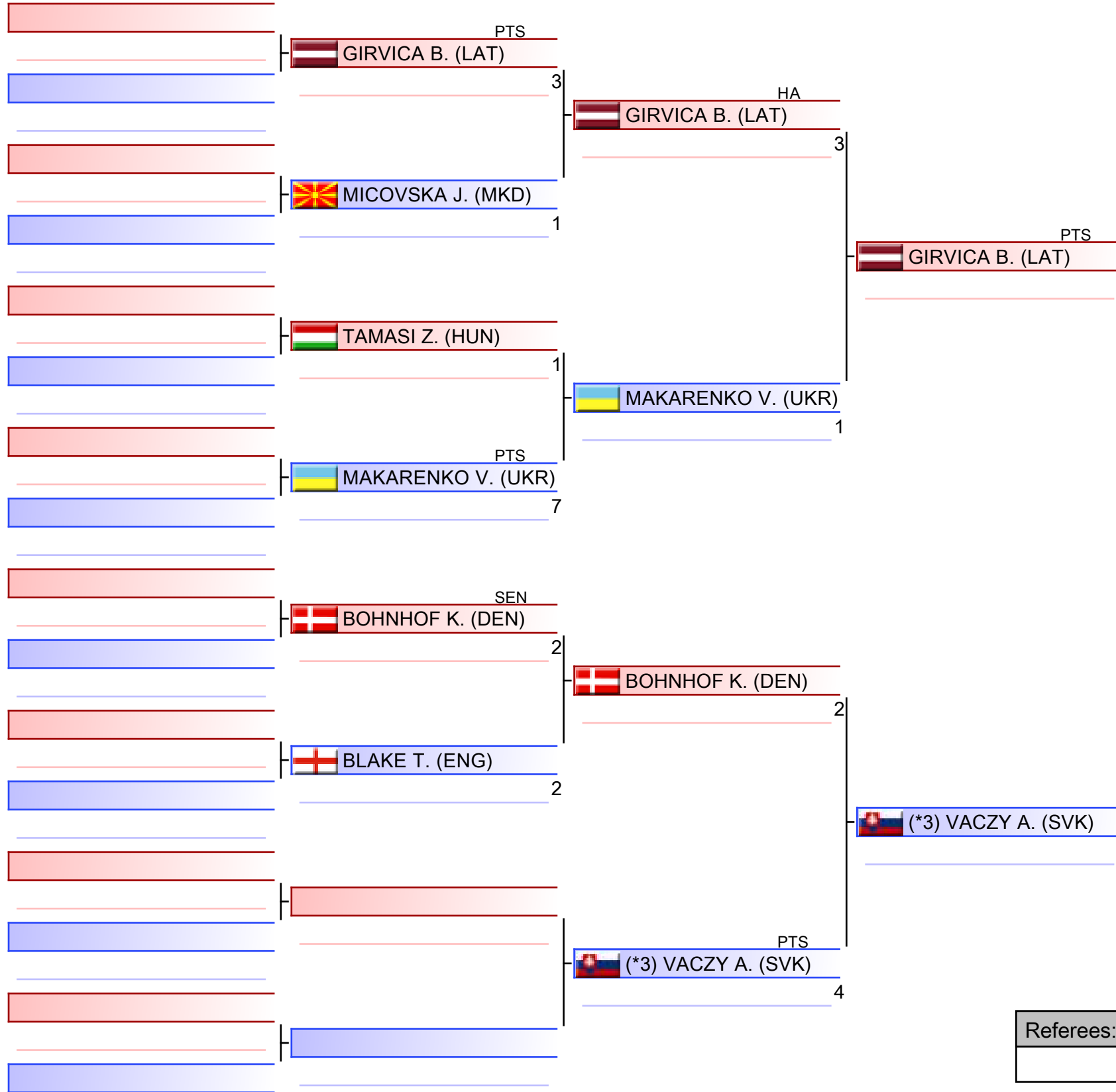

1. GIRVICA BEATA (LAT)
2. BASANGOVA ALTANA (WKF-1)
3. ARZUMIAN MONICA (FRA)
3. FILIPOV NEVENA (SRB)
5. SEMENENKO ANASTASIIA (GER)
5. MAKARENKO VIOLETTA (UKR)
7. MARTURANO IRENE (ITA)
7. VACZY ANNA (SVK)

*Seeded

Referees:			

U21 Kumite Female -61 kg

EKF Junior, Cadet & U21 Championships 2026 - Limassol, Spyros Kyprianou Athletic Center, Limassol, CYP

2026-02-07

Tatami
7 15:30

Pool
2/4

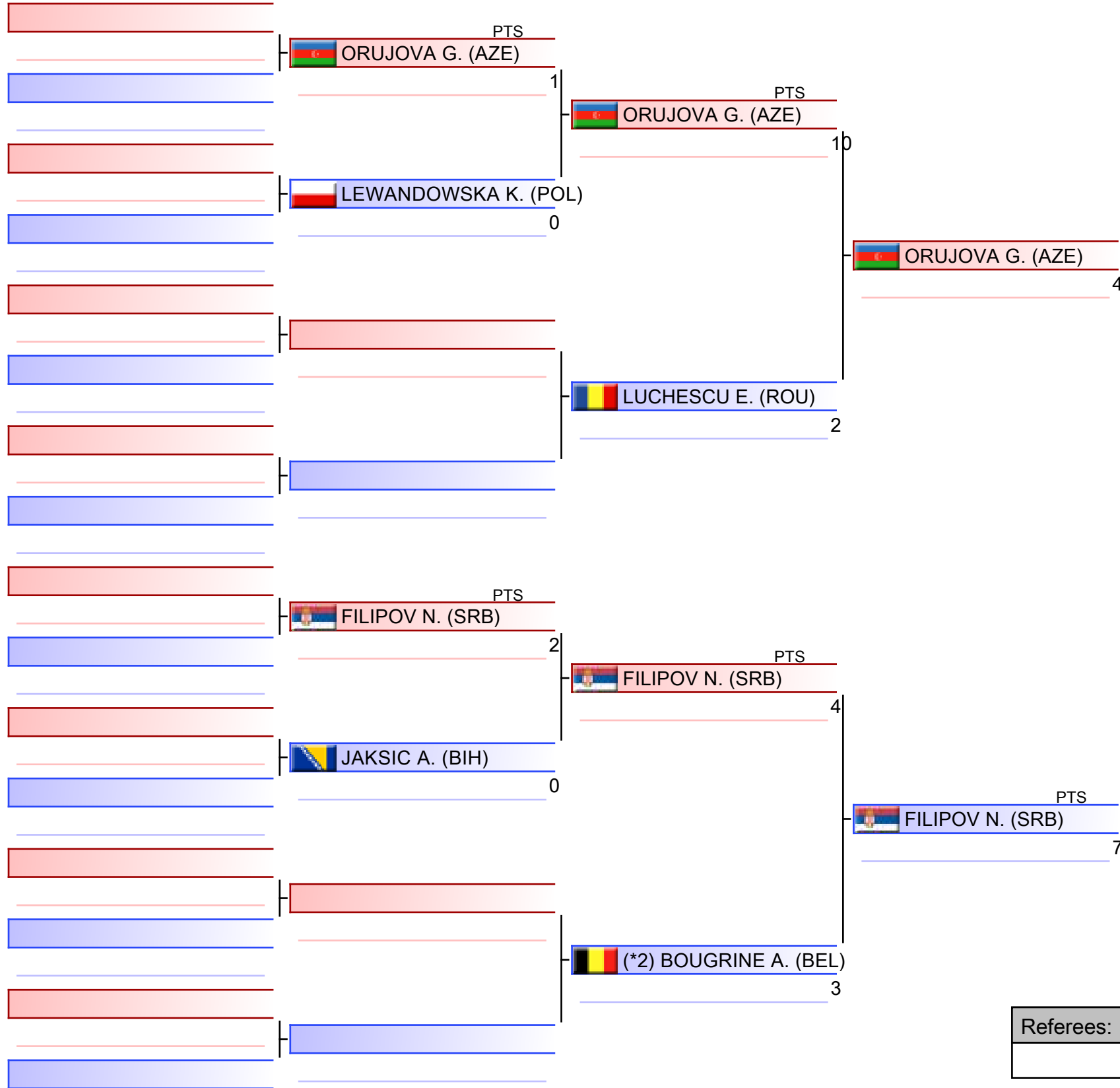

WKF
EUROPE

1. GIRVICA BEATA (LAT)
2. BASANGOVA ALTANA (WKF-1)
3. ARZUMIAN MONICA (FRA)
3. FILIPOV NEVENA (SRB)
5. SEMENENKO ANASTASIIA (GER)
5. MAKARENKO VIOLETTA (UKR)
7. MARTURANO IRENE (ITA)
7. VACZY ANNA (SVK)

*Seeded

Referees:			

U21 Kumite Female -61 kg

EKF Junior, Cadet & U21 Championships 2026 - Limassol, Spyros Kyprianou Athletic Center, Limsassol, CYP

2026-02-07

Tatami
8 14:35

Pool
3/4



WKF
EUROPE

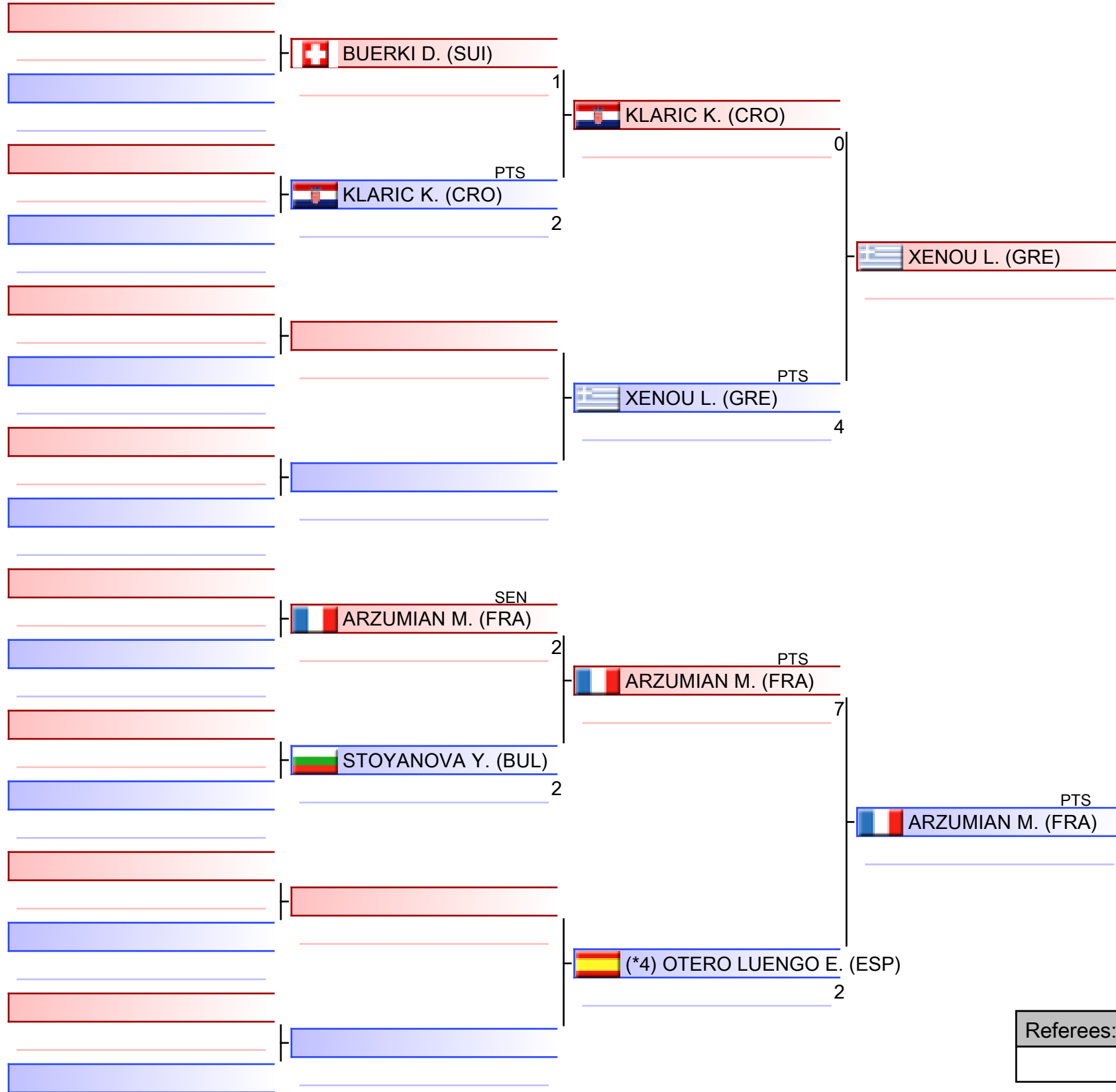

1. GIRVICA BEATA (LAT)
2. BASANGOVA ALTANA (WKF-1)
3. ARZUMIAN MONICA (FRA)
3. FILIPOV NEVENA (SRB)
5. SEMENENKO ANASTASIIA (GER)
5. MAKARENKO VIOLETTA (UKR)
7. MARTURANO IRENE (ITA)
7. VACZY ANNA (SVK)

*Seeded

Referees:			

U21 Kumite Female -61 kg

EKF Junior, Cadet & U21 Championships 2026 - Limassol, Spyros Kyprianou Athletic Center, Limsassol, CYP

2026-02-07

Tatami
8 15:05

Pool
4/4



WKF
EUROPE

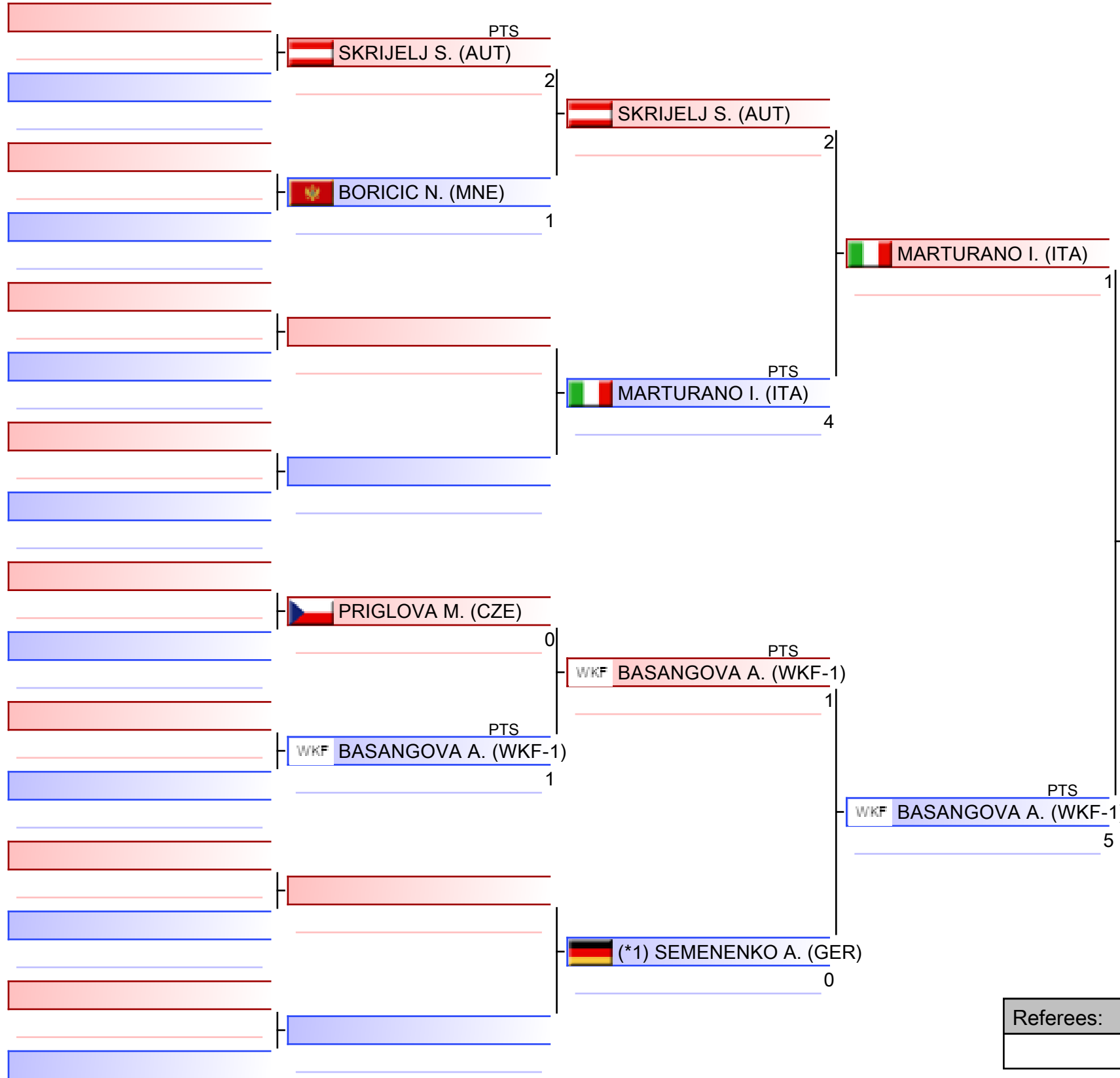

WKF BASANGOVA A. (WKF-1)

1. GIRVICA BEATA (LAT)
2. BASANGOVA ALTANA (WKF-1)
3. ARZUMIAN MONICA (FRA)
3. FILIPOV NEVENA (SRB)
5. SEMENENKO ANASTASIIA (GER)
5. MAKARENKO VIOLETTA (UKR)
7. MARTURANO IRENE (ITA)
7. VACZY ANNA (SVK)

*Seeded

Referees:			

Pool winner-U21 Kumite Female -61 kg

EKF Junior, Cadet & U21 Championships 2026 - Limassol, Spyros Kyprianou Athletic Center, Limsassol, CYP

2026-02-07

Tatami
7 16:00

Pool
1/1



WKF
EUROPE

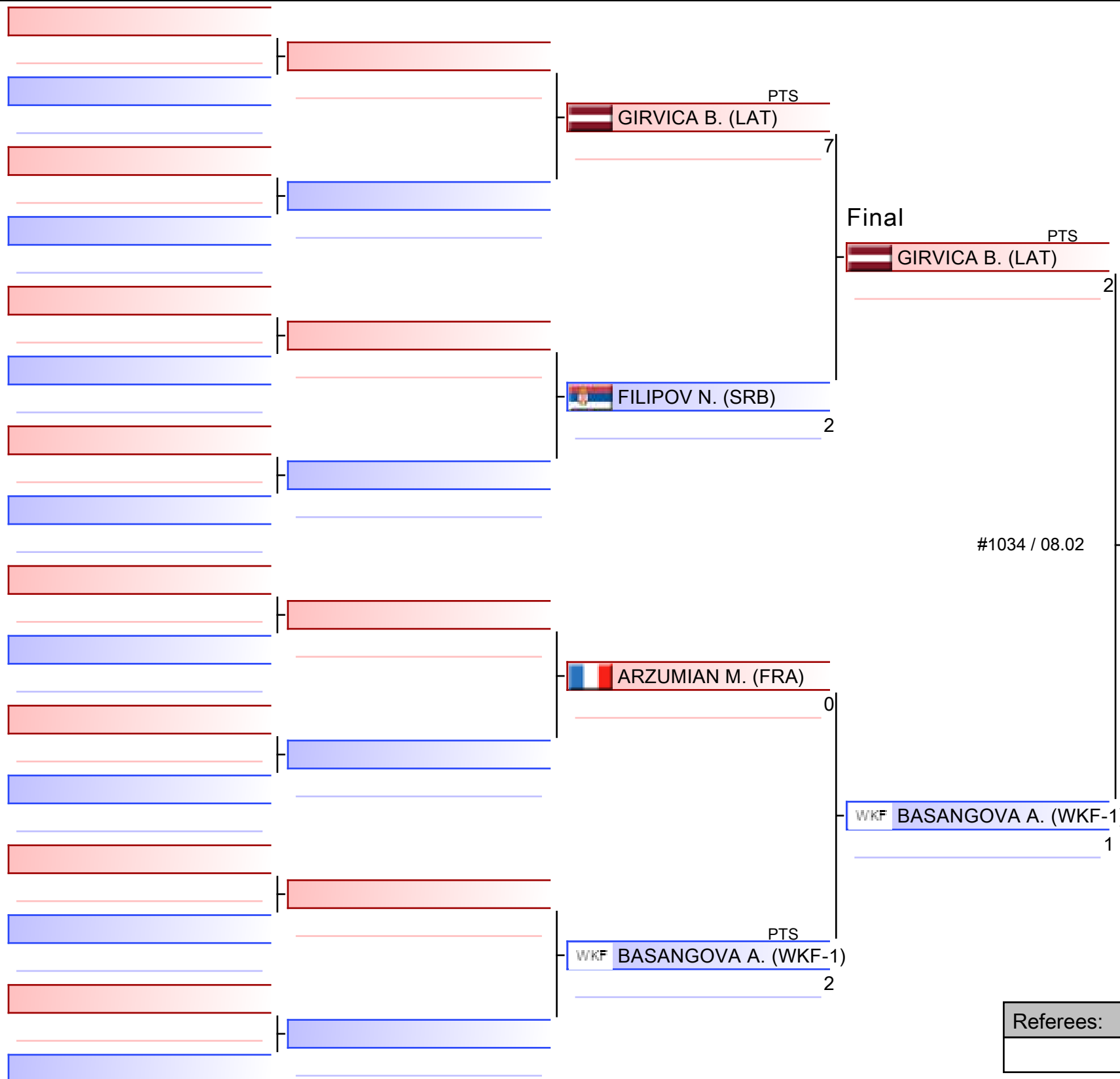

1. GIRVICA BEATA (LAT)
2. BASANGOVA ALTANA (WKF-1)
3. ARZUMIAN MONICA (FRA)
3. FILIPOV NEVENA (SRB)
5. SEMENENKO ANASTASIIA (GER)
5. MAKARENKO VIOLETTA (UKR)
7. MARTURANO IRENE (ITA)
7. VACZY ANNA (SVK)

*Seeded

Referees:			

U21 Kumite Female -61 kg

EKF Junior, Cadet & U21 Championships 2026 - Limassol

2026-02-07

Tatami
6 18:00

Pool
1,2,3,4

(c)sportdata GmbH & Co KG 2000-2026 (2026-02-08 17:46) v 11.0.0 build 2 (2025-01-21 11:49 CET) License: SDIL TWG2025 (expire 2026-09-30)

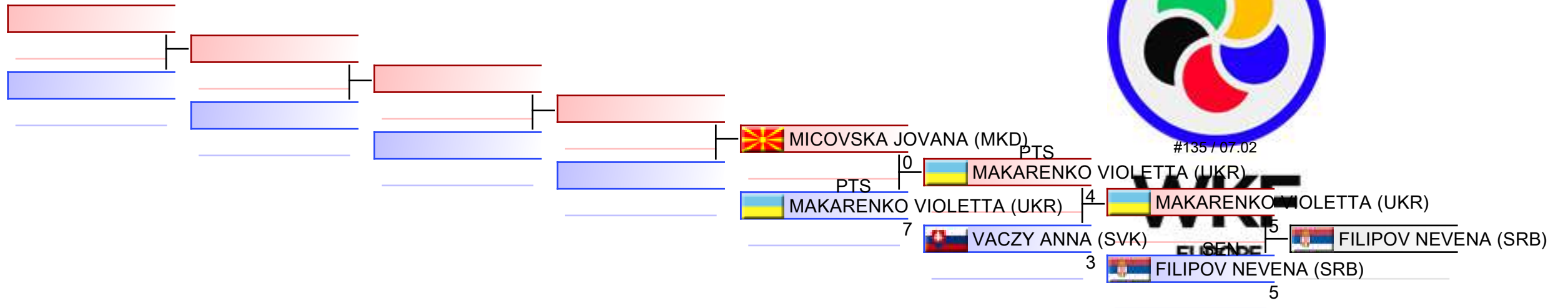

REPECHAGE: (1,2,3,4)

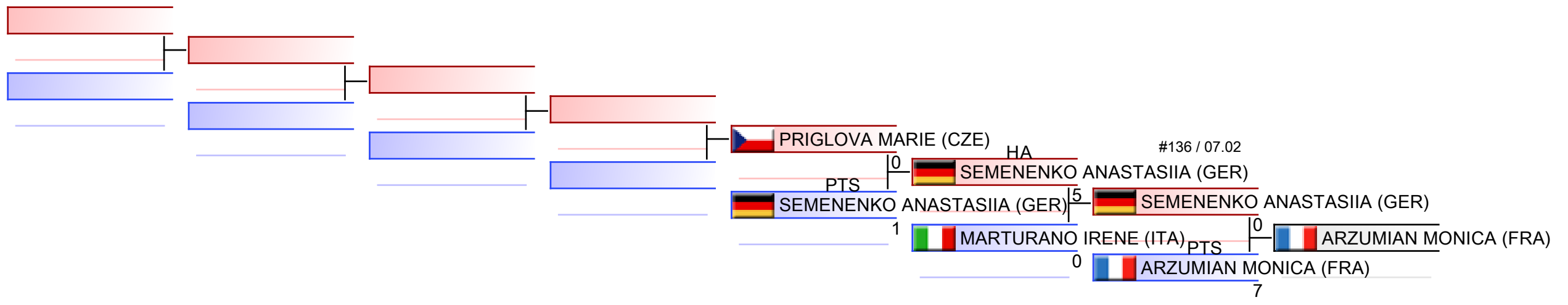

Referees:							
-----------	--	--	--	--	--	--	--



EKF Junior, Cadet & U21 Championships
2026 - Limassol - 2026-02-06



Official Results

U21 Kumite Female -61 kg			
1	GIRVICA BEATA		LAT - LATVIA
2	BASANGOVA ALTANA		WKF-1 - WKF-1
3	ARZUMIAN MONICA		FRA - FRANCE
3	FILIPOV NEVENA		SRB - SERBIA
5	SEMENENKO ANASTASIIA		GER - GERMANY
5	MAKARENKO VIOLETTA		UKR - UKRAINE
7	MARTURANO IRENE		ITA - ITALY
7	VACZY ANNA		SVK - SLOVAKIA
9	PRIGLOVA MARIE		CZE - CZECH REPUBLIC
9	MICOVSKA JOVANA		MKD - NORTH MACEDONIA

U21 KUMITE FEMALE -68 KG



EKF Junior, Cadet & U21 Championships 2026 - Lim..



ENTRIES BY WEIGHT CATEGORY

U21 Kumite Female -68 kg

As of 8 FEB 2026

Code	ID	Gender	Name	Seeding
AZE	AZE2234	F	ALIYEVA AYSU	
BIH	BIH2604	F	SIPOVIC AJLA	
CRO	CRO2838	F	LUKENDA NINA	
CYP	CYP02925	F	PRIGKIPA ATHENA	
CZE	CZE02253	F	TINAVSKA EMA	3
DEN	DEN02706	F	HENRIKSEN VANESSA	
ENG	ENG02901	F	WYMAN JESSE	
ESP	ESP03479	F	JUST CLOPES JULIA	
EST	EST02460	F	LETT ANNALIISA	
FIN	FIN02259	F	SAADAOUI SONYA	
FRA	FRA03306	F	PORQUET FAITH	4
GEO	GEO002922	F	PIRTSKHALAVA LIKA	
GER	GER03137	F	FRATILA CRISTINA-MARIA	
GRE	GRE02442	F	KATSIKA EIRINI-GRIGORIA	2
HUN	HUN02618	F	BOGDAN PANNA ZSOFIA	
ITA	ITA04269	F	DESIDERIO ANNA PIA	1
LTU	LTU02421	F	VARANKINAITE KAMILE	
MKD	MKD2557	F	KOXHA ERA	
MNE	MNE2257	F	ZAHRANE MARIAM	
NED	NED02697	F	ZWANENBURG ROBIN	
POL	POL3284	F	CICHOSZEWSKA NATASZA	
POR	POR03062	F	FLORES EVA	
ROU	ROU03095	F	IVASCU LARISA ADRIANA	
SCO	SCO02195	F	FITAL KORI	
SLO	SLO02759	F	CERU JERNEJA	
SRB	SRB03577	F	KRSTOVIC TEODORA	
SVK	SVK02759	F	KALAMAROVA ALEXANDRA	
SWE	SWE003350	F	JAKESEVIC IVANA	
UKR	UKR02922	F	VOLOSHYN SOLOMIIA	
WKF-1	AIN-1006438	F	BIKMETOVA AIDA	

U21 Kumite Female -68 kg

EKF Junior, Cadet & U21 Championships 2026 - Limassol, Spyros Kyprianou Athletic Center, Limassol, CYP

2026-02-07

Tatami
1 16:05

Pool
1/4

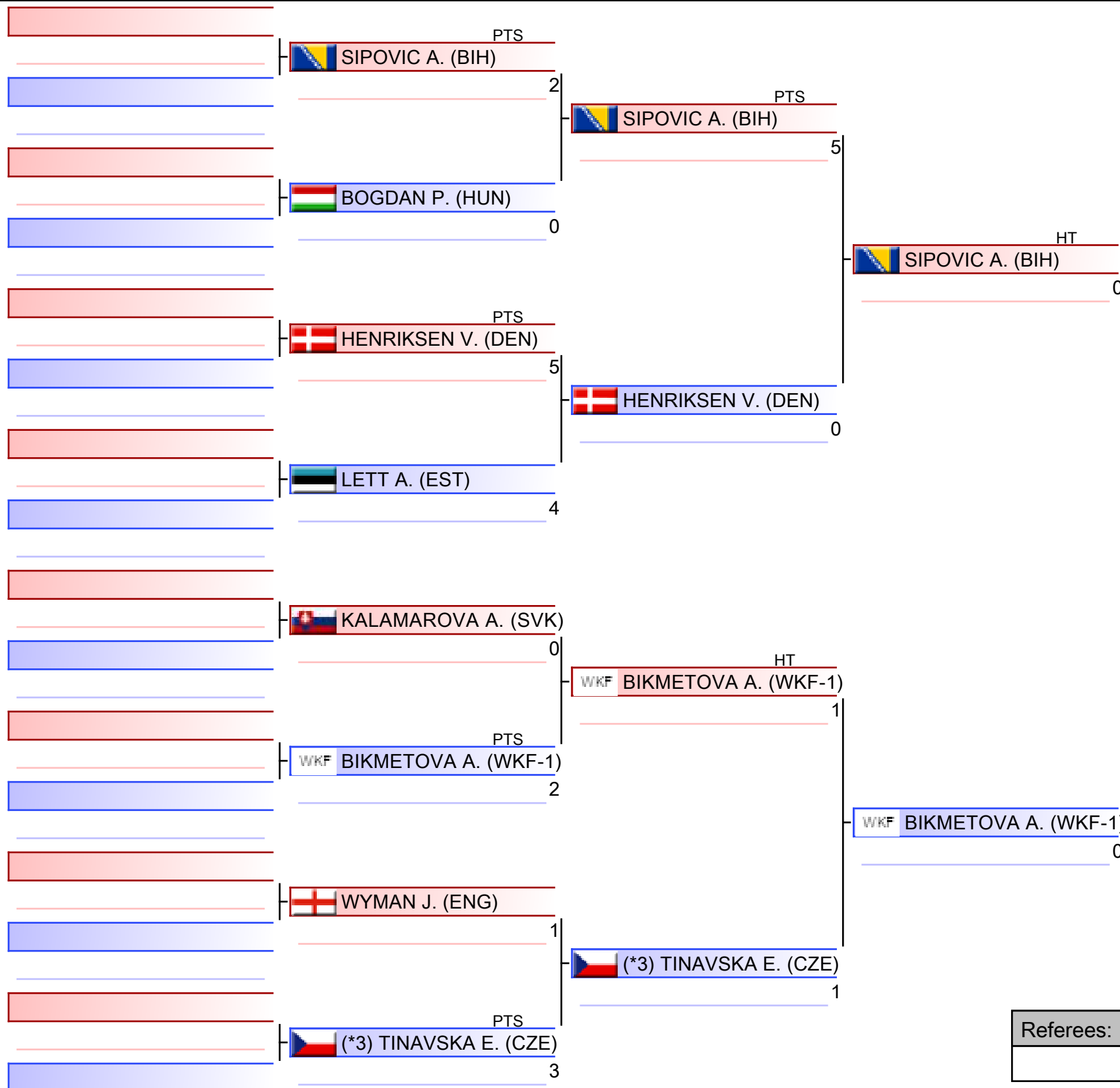

WKF
EUROPE

SIPOVIC A. (BIH)

1. KATSIKA EIRINI-GRIGORIA (GRE)
2. KRSTOVIC TEODORA (SRB)
3. SIPOVIC AJLA (BIH)
3. JUST CLOPES JULIA (ESP)
5. ZWANENBURG ROBIN (NED)
5. DESIDERIO ANNA PIA (ITA)
7. KOXHA ERA (MKD)
7. FRATILA CRISTINA-MARIA (GER)

*Seeded

Referees:			

U21 Kumite Female -68 kg

EKF Junior, Cadet & U21 Championships 2026 - Limassol, Spyros Kyprianou Athletic Center, Limassol, CYP

2026-02-07

Tatami
1 16:50

Pool
2/4



WKF
EUROPE

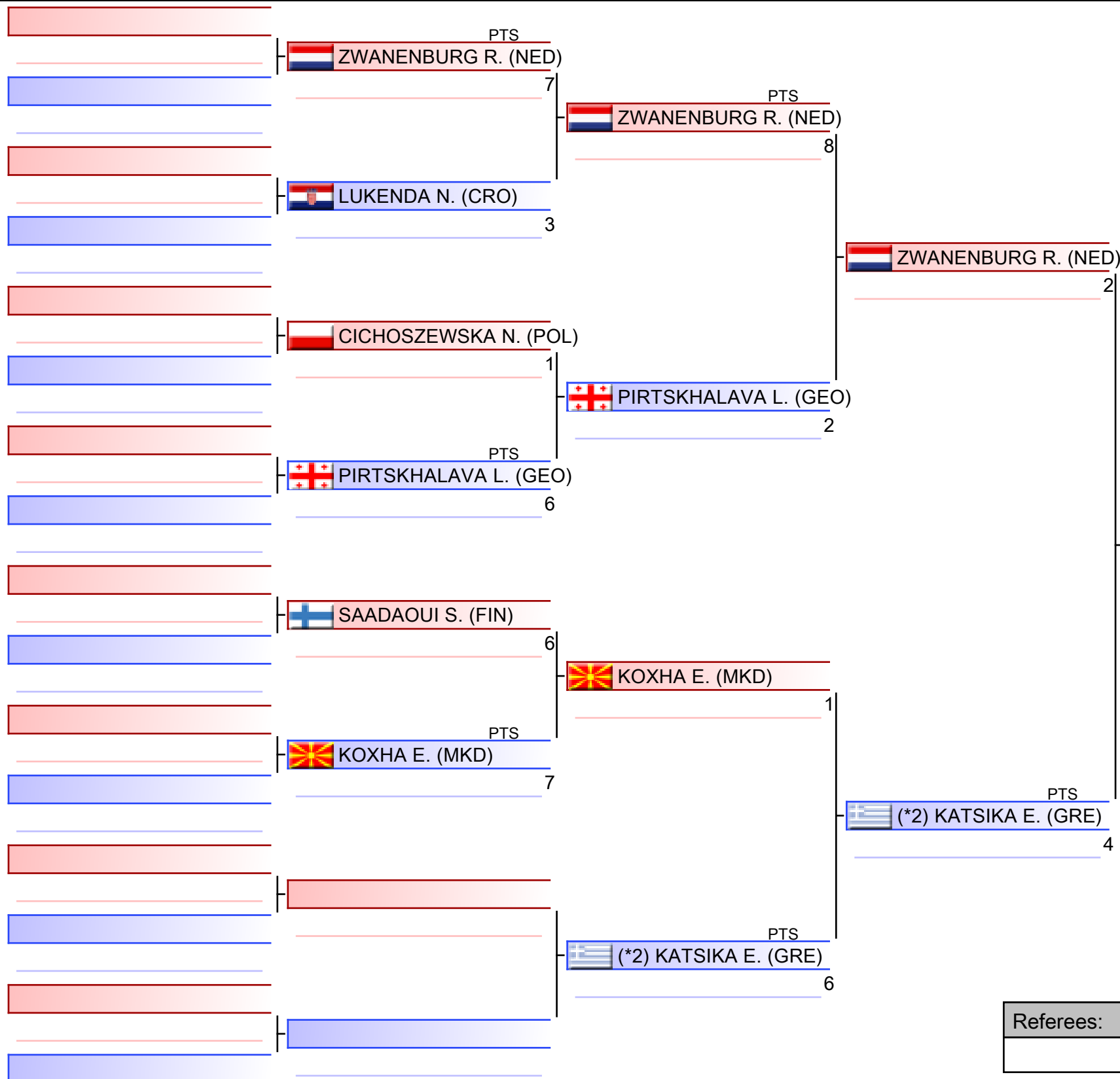

(*2) KATSIKA E. (GRE)

1. KATSIKA EIRINI-GRIGORIA (GRE)
2. KRSTOVIC TEODORA (SRB)
3. SIPOVIC AJLA (BIH)
3. JUST CLOPES JULIA (ESP)
5. ZWANENBURG ROBIN (NED)
5. DESIDERIO ANNA PIA (ITA)
7. KOXHA ERA (MKD)
7. FRATILA CRISTINA-MARIA (GER)

*Seeded

Referees:			

U21 Kumite Female -68 kg

EKF Junior, Cadet & U21 Championships 2026 - Limassol, Spyros Kyprianou Athletic Center, Limassol, CYP

2026-02-07

Tatami
2 15:45

Pool
3/4



WKF
EUROPE

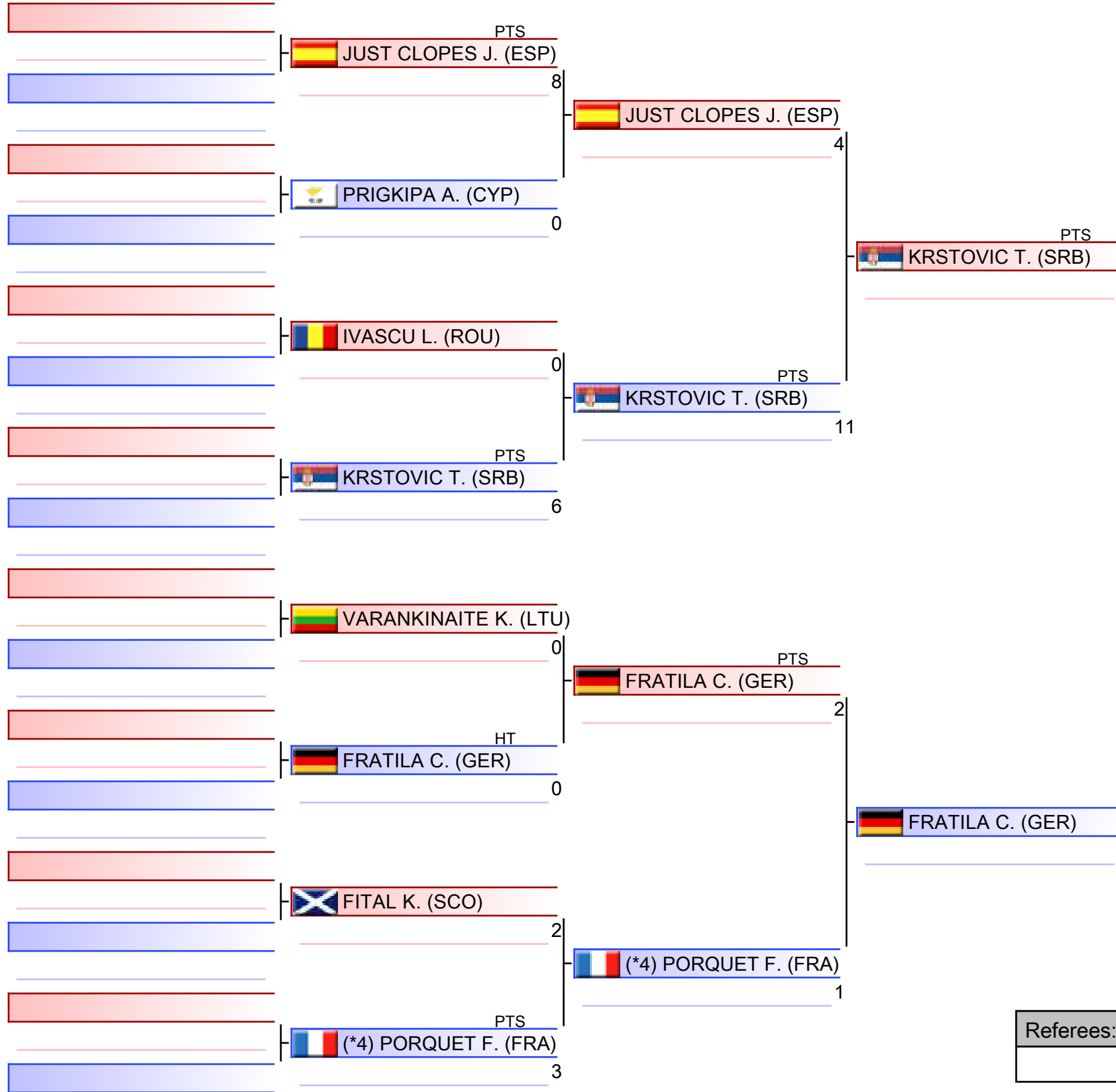

1. KATSIKA EIRINI-GRIGORIA (GRE)
2. KRSTOVIC TEODORA (SRB)
3. SIPOVIC AJLA (BIH)
3. JUST CLOPES JULIA (ESP)
5. ZWANENBURG ROBIN (NED)
5. DESIDERIO ANNA PIA (ITA)
7. KOXHA ERA (MKD)
7. FRATILA CRISTINA-MARIA (GER)

*Seeded

Referees:			

U21 Kumite Female -68 kg

EKF Junior, Cadet & U21 Championships 2026 - Limassol, Spyros Kyprianou Athletic Center, Limassol, CYP

2026-02-07

Tatami
2 16:30

Pool
4/4



WKF
EUROPE

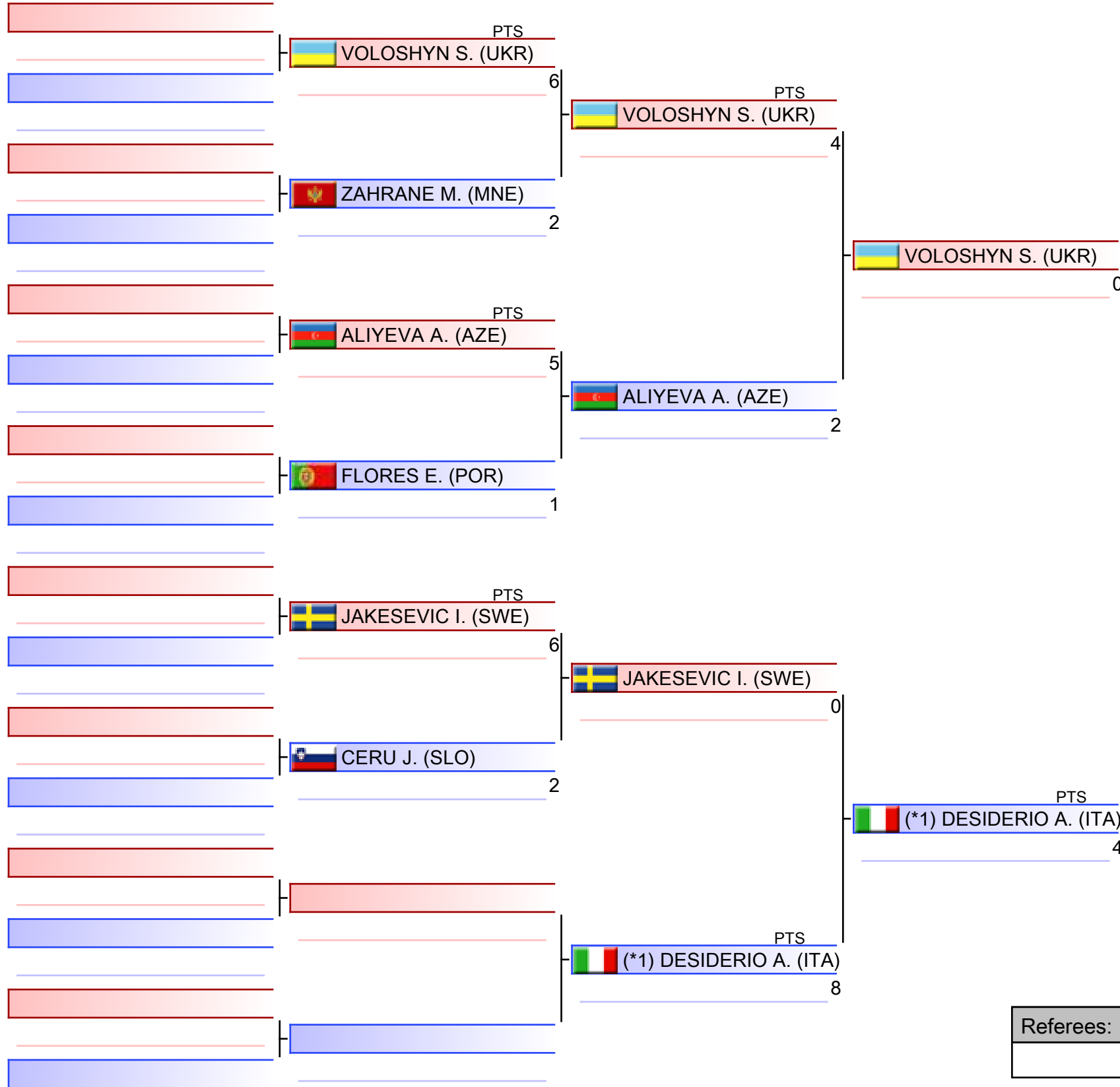

(*1) DESIDERIO A. (ITA)

1. KATSIKA EIRINI-GRIGORIA (GRE)
2. KRSTOVIC TEODORA (SRB)
3. SIPOVIC AJLA (BIH)
3. JUST CLOPES JULIA (ESP)
5. ZWANENBURG ROBIN (NED)
5. DESIDERIO ANNA PIA (ITA)
7. KOXHA ERA (MKD)
7. FRATILA CRISTINA-MARIA (GER)

*Seeded

Referees:			

Pool winner-U21 Kumite Female -68 kg

EKF Junior, Cadet & U21 Championships 2026 - Limassol, Spyros Kyprianou Athletic Center, Limsassol, CYP

2026-02-07

Tatami
1 17:25

Pool
1/1

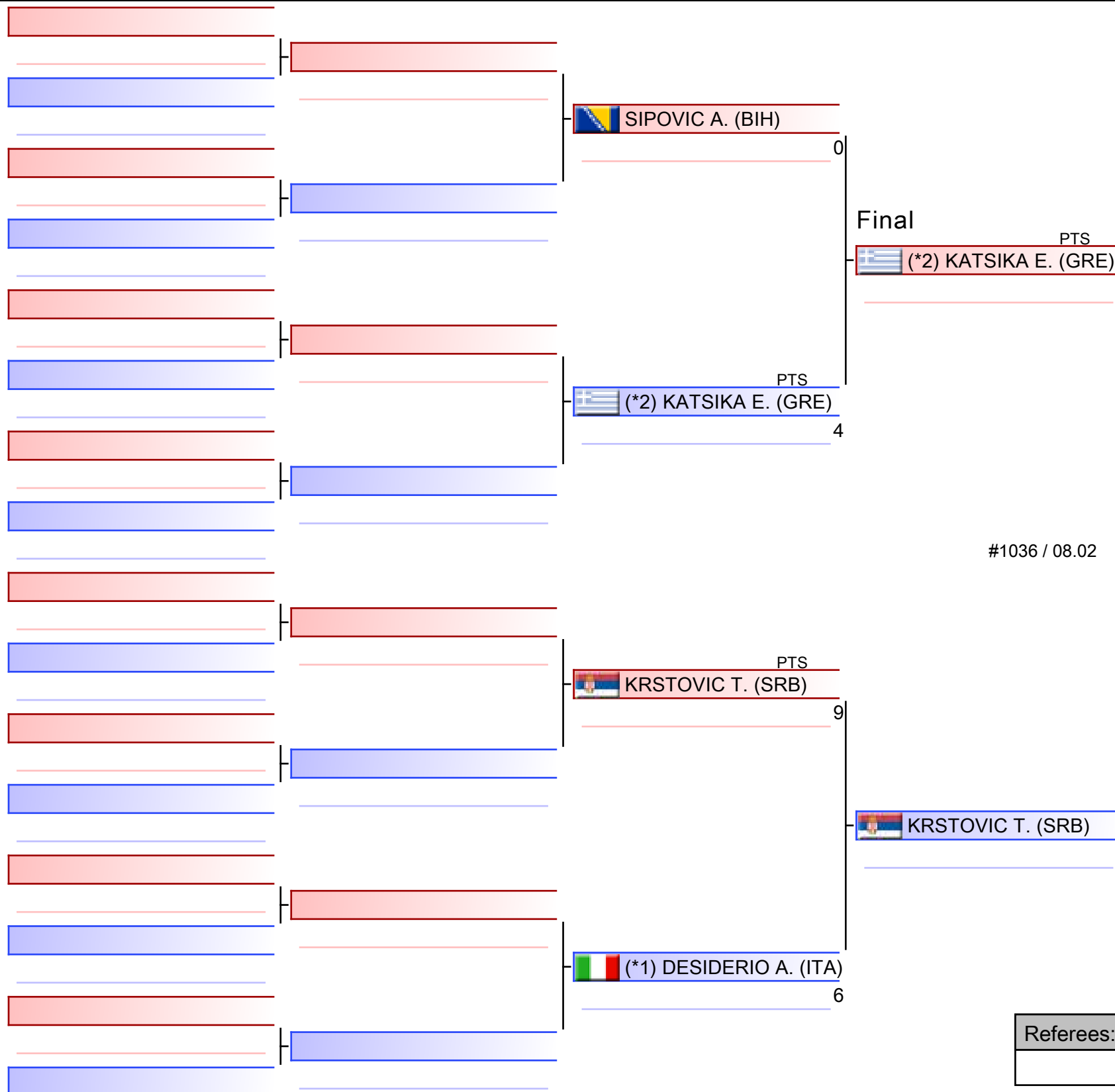

WKF
EUROPE

#1036 / 08.02

1. KATSIKA EIRINI-GRIGORIA (GRE)
2. KRSTOVIC TEODORA (SRB)
3. SIPOVIC AJLA (BIH)
3. JUST CLOPES JULIA (ESP)
5. ZWANENBURG ROBIN (NED)
5. DESIDERIO ANNA PIA (ITA)
7. KOXHA ERA (MKD)
7. FRATILA CRISTINA-MARIA (GER)

*Seeded

Referees:			

U21 Kumite Female -68 kg

EKF Junior, Cadet & U21 Championships 2026 - Limassol

2026-02-07

Tatami
7 18:00

Pool
1,2,3,4

(c)sportdata GmbH & Co KG 2000-2026 (2026-02-08 17:46) v 11.0.0 build 2 (2025-01-21 11:49 CET) License: SDIL TWG2025 (expire 2026-09-30)



#137 / 07.02

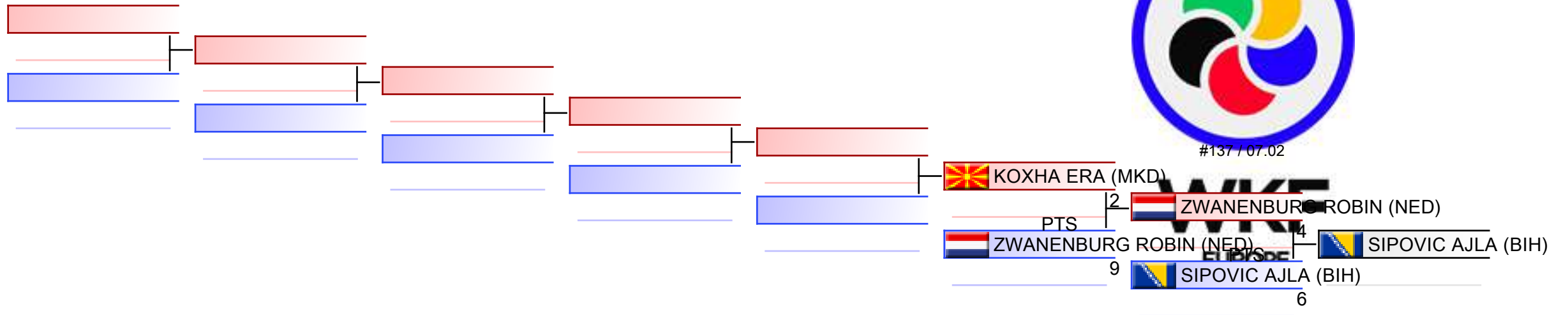

REPECHAGE: (1,2,3,4)

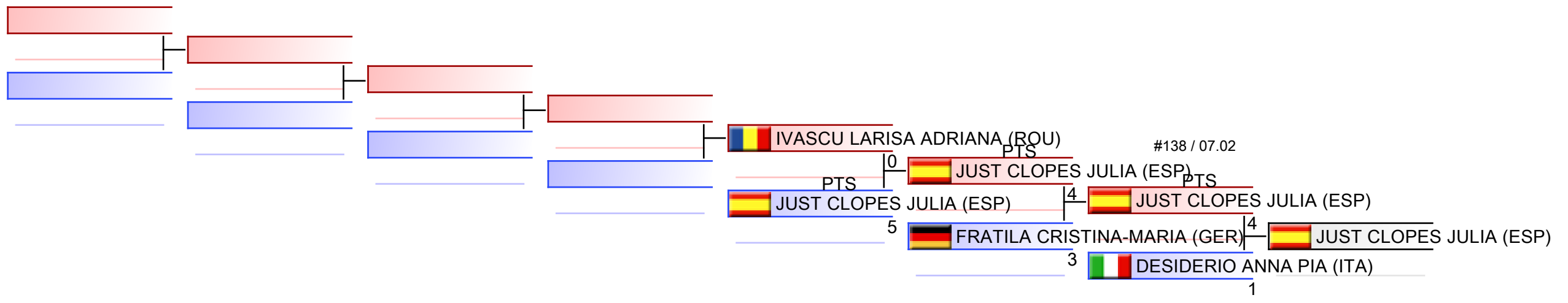

Referees:							
-----------	--	--	--	--	--	--	--



EKF Junior, Cadet & U21 Championships
2026 - Limassol - 2026-02-06



Official Results

U21 Kumite Female -68 kg			
1	KATSIKA EIRINI-GRIGORIA		GRE - GREECE
2	KRSTOVIC TEODORA		SRB - SERBIA
3	SIPOVIC AJLA		BIH - BOSNIA AND HERZEGOVINA
3	JUST CLOPES JULIA		ESP - SPAIN
5	ZWANENBURG ROBIN		NED - NETHERLANDS
5	DESIDERIO ANNA PIA		ITA - ITALY
7	KOXHA ERA		MKD - NORTH MACEDONIA
7	FRATILA CRISTINA-MARIA		GER - GERMANY
9	IVASCU LARISA ADRIANA		ROU - ROMANIA

U21 KUMITE FEMALE 68+ KG



EKF Junior, Cadet & U21 Championships 2026 - Lim..



ENTRIES BY WEIGHT CATEGORY

U21 Kumite Female 68+ kg

As of 8 FEB 2026

Code	ID	Gender	Name	Seeding
AUT	AUT02524	F	SCHUETZE EMMA	4
BIH	BIH2895	F	LEKANIC SELENA	
CRO	CRO2841	F	TOMIC SARA	
CYP	CYP02769	F	DEMETRIOU CHARA	
CZE	CZE02248	F	HAKOVA AMALIE	
DEN	DEN02466	F	BATH ASTAMAJA	
ENG	ENG02912	F	FRY AUTUMN	
ESP	ESP03891	F	LARRA PARDO SARA	
FRA	FRA03455	F	OZSERTTAS ZERA JADE	
GER	GER03138	F	RUEHLMANN CHARLOTTE	
GRE	GRE02831	F	ANASTASIOU MARIA GEORGIA	
HUN	HUN02677	F	FLEISCHER DORA	1
IRL	IRL02797	F	CLARE AVA	
ITA	ITA03079	F	PERGOLESI ASIA	2
MKD	MKD03119	F	ZIBERI ERDONA	
MNE	MNE2290	F	DAMJANOVIC JOVANA	
POL	POL04919	F	JEDRZEJEWSKA AMELIA	
ROU	ROU03097	F	ADOCHITEI MARIA	
SRB	SRB2507	F	RAJIC DUNJA	
SUI	SUI02568	F	BONNY SHANIA	
SVK	SVK003407	F	HAJDUKOVA JANA	
SWE		F	GULLAN SOFIA HELENA ENGMAN	
UKR	UKR02864	F	BULAY DARIIA	3
WKF-1	RUS03672	F	SHISHOVA KSENIYA	
WKF-2	BLR02353	F	MALAKHAVA MARYIA	

U21 Kumite Female 68+ kg

EKF Junior, Cadet & U21 Championships 2026 - Limassol, Spyros Kyprianou Athletic Center, Limassol, CYP

2026-02-07

Tatami
3 16:35

Pool
1/4

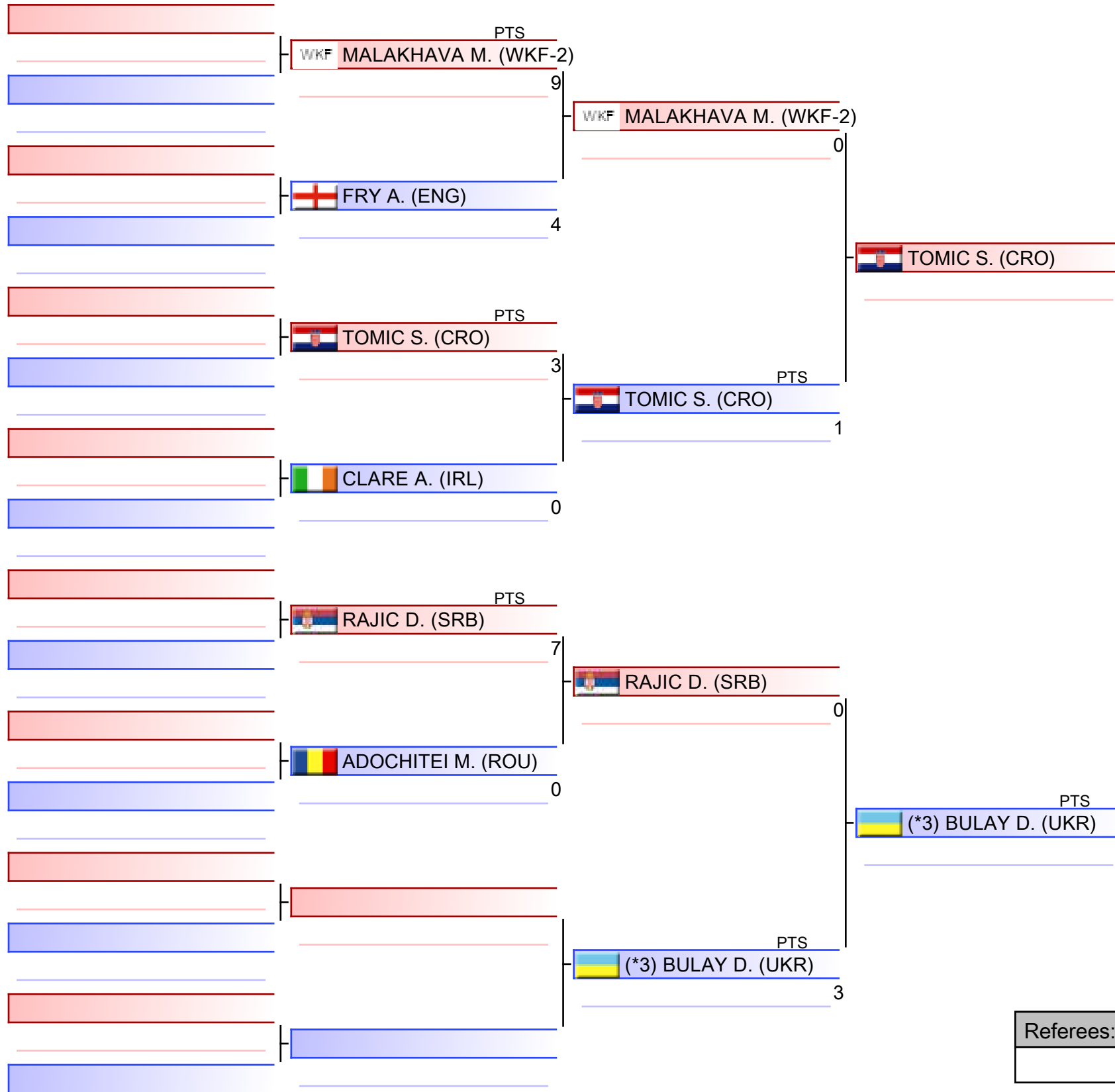

WKF
EUROPE

(*3) BULAY D. (UKR)

1. BULAY DARIIA (UKR)
2. FLEISCHER DORA (HUN)
3. TOMIC SARA (CRO)
3. HAKOVA AMALIE (CZE)
5. BATH ASTAMAJA (DEN)
5. ZIBERI ERDONA (MKD)
7. RAJIC DUNJA (SRB)
7. GULLAN SOFIA HELENA ENGMAN (SWE)

*Seeded

Referees:			

U21 Kumite Female 68+ kg

EKF Junior, Cadet & U21 Championships 2026 - Limassol, Spyros Kyprianou Athletic Center, Limassol, CYP

2026-02-07

Tatami
3 17:10

Pool
2/4



WKF
EUROPE

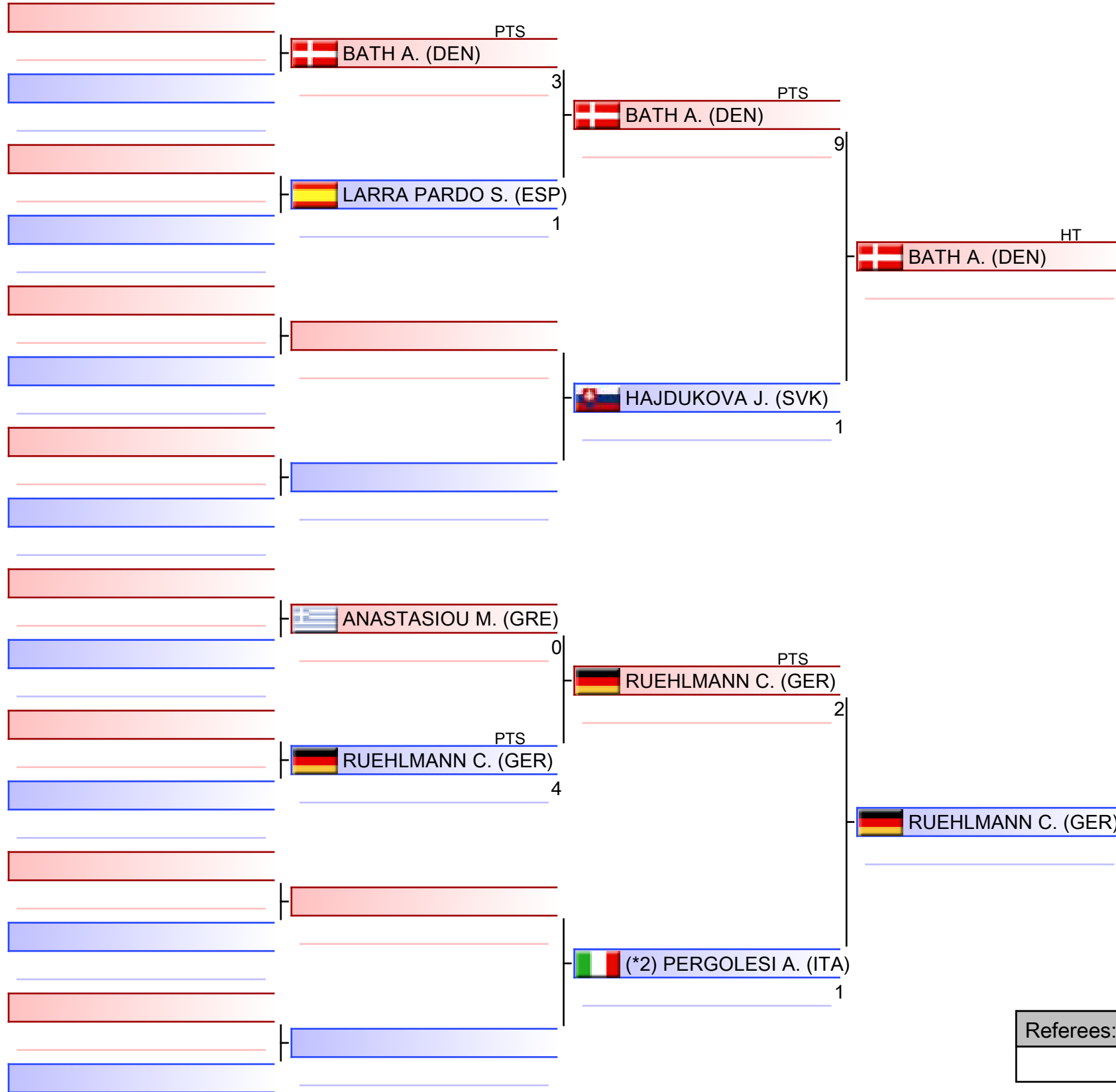

1. BULAY DARIIA (UKR)
2. FLEISCHER DORA (HUN)
3. TOMIC SARA (CRO)
3. HAKOVA AMALIE (CZE)
5. BATH ASTAMAJA (DEN)
5. ZIBERI ERDONA (MKD)
7. RAJIC DUNJA (SRB)
7. GULLAN SOFIA HELENA ENGMAN (SWE)

*Seeded

Referees:			

U21 Kumite Female 68+ kg

EKF Junior, Cadet & U21 Championships 2026 - Limassol, Spyros Kyprianou Athletic Center, Limassol, CYP

2026-02-07

Tatami
4 16:30

Pool
3/4



WKF
EUROPE

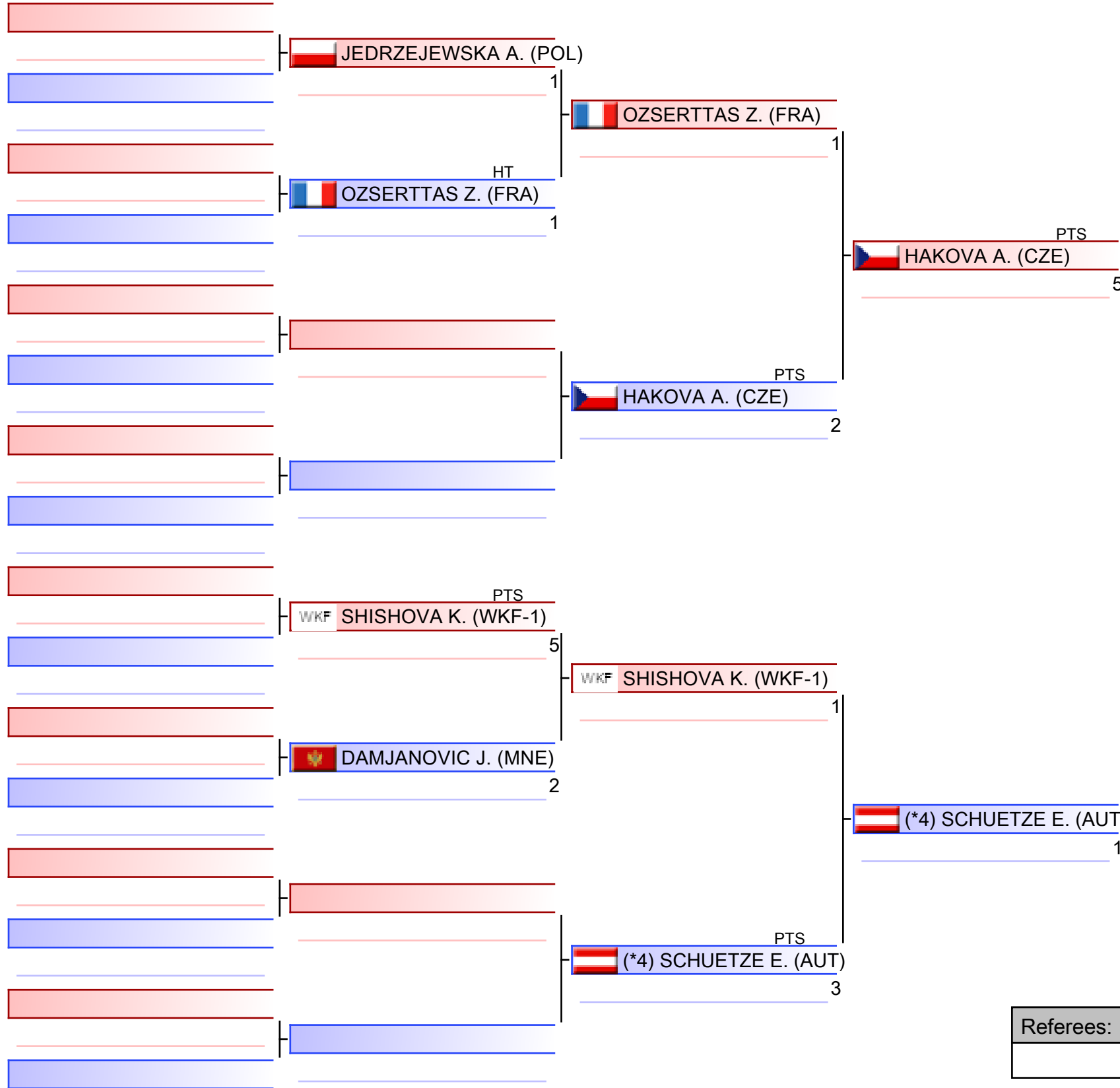

HAKOVA A. (CZE)

1. BULAY DARIIA (UKR)
2. FLEISCHER DORA (HUN)
3. TOMIC SARA (CRO)
3. HAKOVA AMALIE (CZE)
5. BATH ASTAMAJA (DEN)
5. ZIBERI ERDONA (MKD)
7. RAJIC DUNJA (SRB)
7. GULLAN SOFIA HELENA ENGMAN (SWE)

*Seeded

Referees:			

U21 Kumite Female 68+ kg

EKF Junior, Cadet & U21 Championships 2026 - Limassol, Spyros Kyprianou Athletic Center, Limassol, CYP

2026-02-07

Tatami
4 17:00

Pool
4/4



WKF
EUROPE

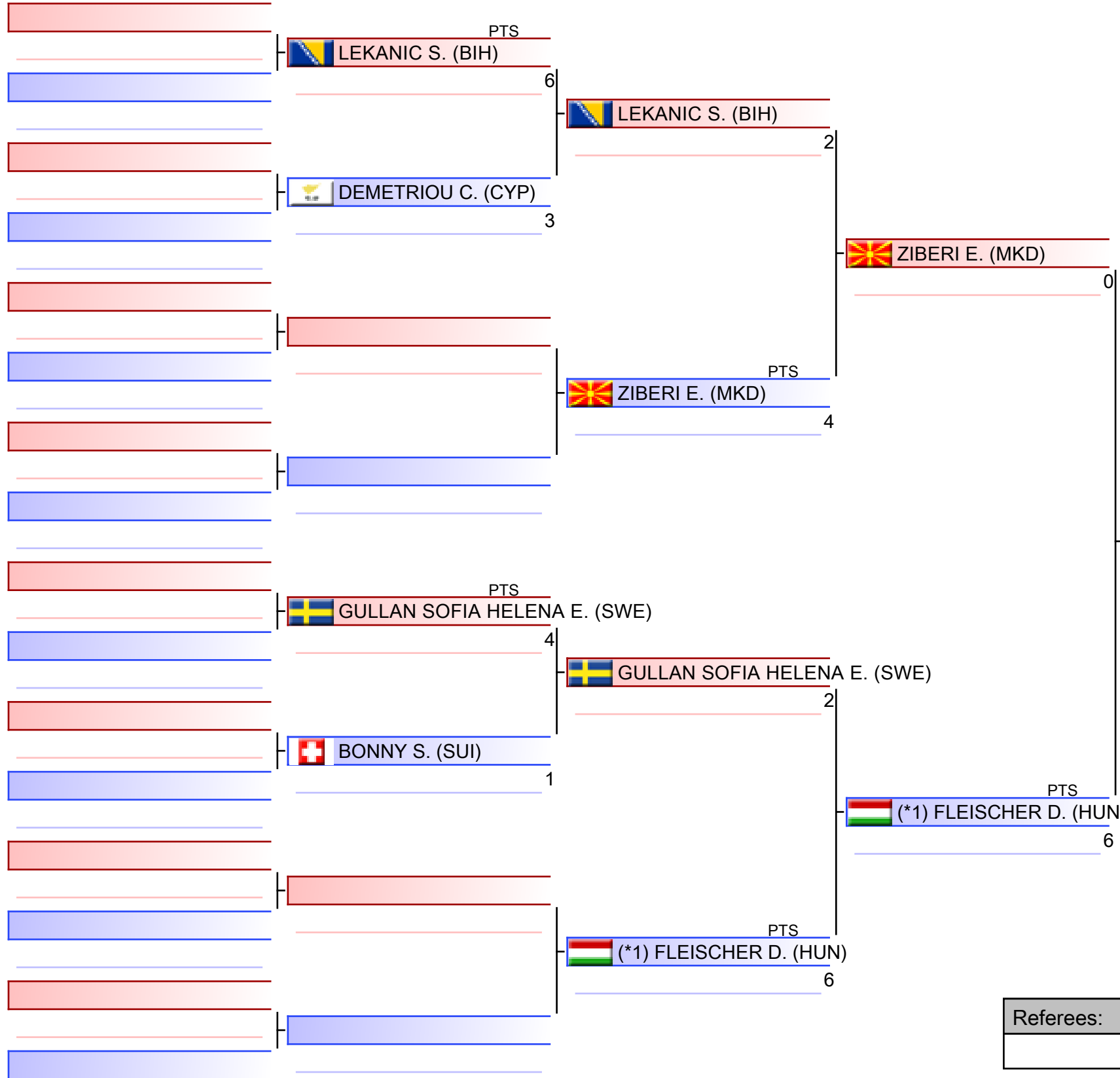

(*1) FLEISCHER D. (HUN)

1. BULAY DARIIA (UKR)
2. FLEISCHER DORA (HUN)
3. TOMIC SARA (CRO)
3. HAKOVA AMALIE (CZE)
5. BATH ASTAMAJA (DEN)
5. ZIBERI ERDONA (MKD)
7. RAJIC DUNJA (SRB)
7. GULLAN SOFIA HELENA ENGMAN (SWE)

*Seeded

Referees:			

Pool winner-U21 Kumite Female 68+ kg

EKF Junior, Cadet & U21 Championships 2026 - Limassol, Spyros Kyprianou Athletic Center, Limsassol, CYP

2026-02-07

Tatami
3 17:40

Pool
1/1



WKF
EUROPE

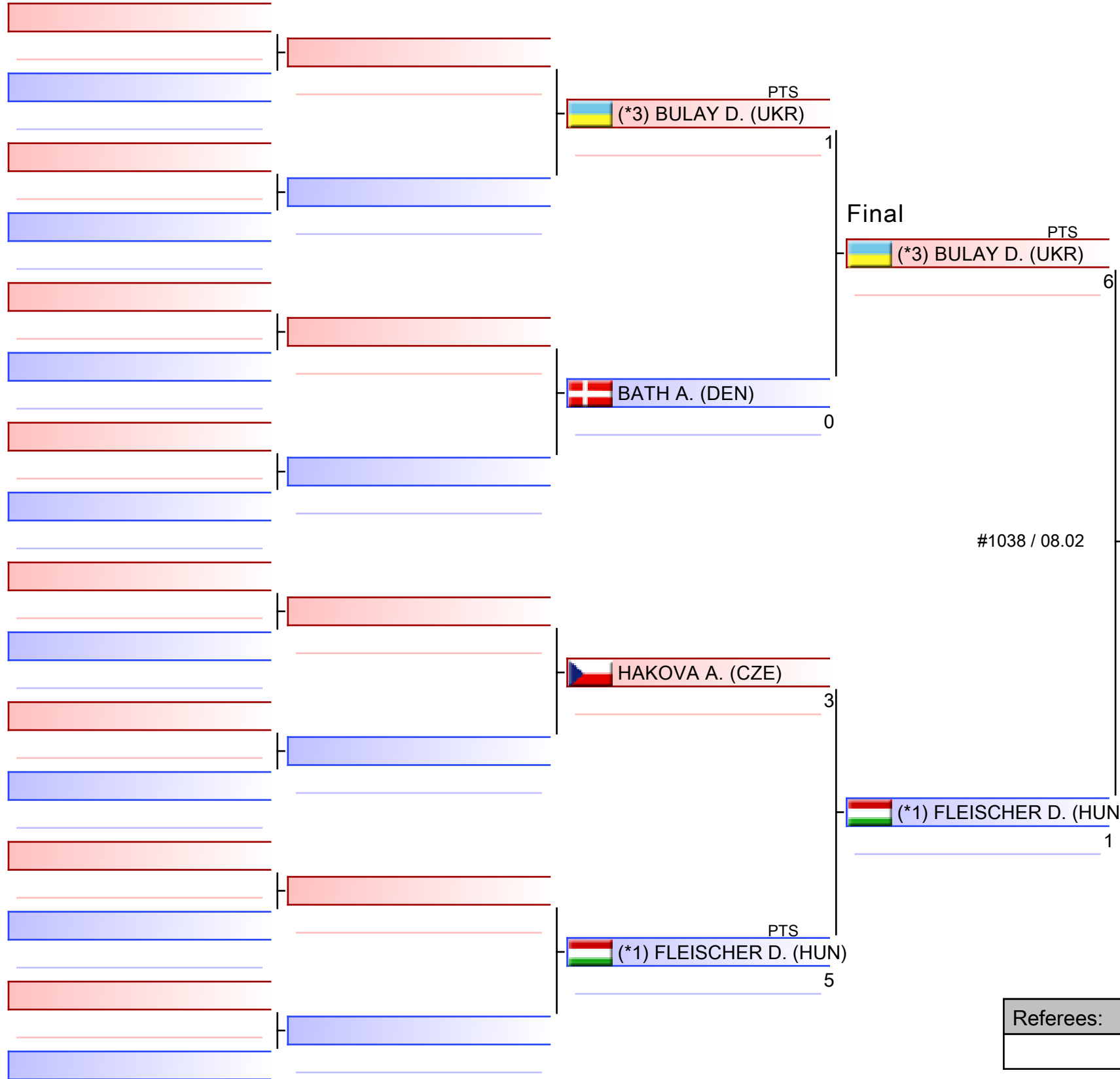

1. BULAY DARIIA (UKR)
2. FLEISCHER DORA (HUN)
3. TOMIC SARA (CRO)
3. HAKOVA AMALIE (CZE)
5. BATH ASTAMAJA (DEN)
5. ZIBERI ERDONA (MKD)
7. RAJIC DUNJA (SRB)
7. GULLAN SOFIA HELENA ENGMAN (SWE)

*Seeded

Referees:			

U21 Kumite Female 68+ kg

EKF Junior, Cadet & U21 Championships 2026 - Limassol

2026-02-07

Tatami
2 18:10

Pool
1,2,3,4

(c)sportdata GmbH & Co KG 2000-2026 (2026-02-08 17:46) v 11.0.0 build 2 (2025-01-21 11:49 CET) License: SDIL TWG2025 (expire 2026-09-30)



#139 / 07.02

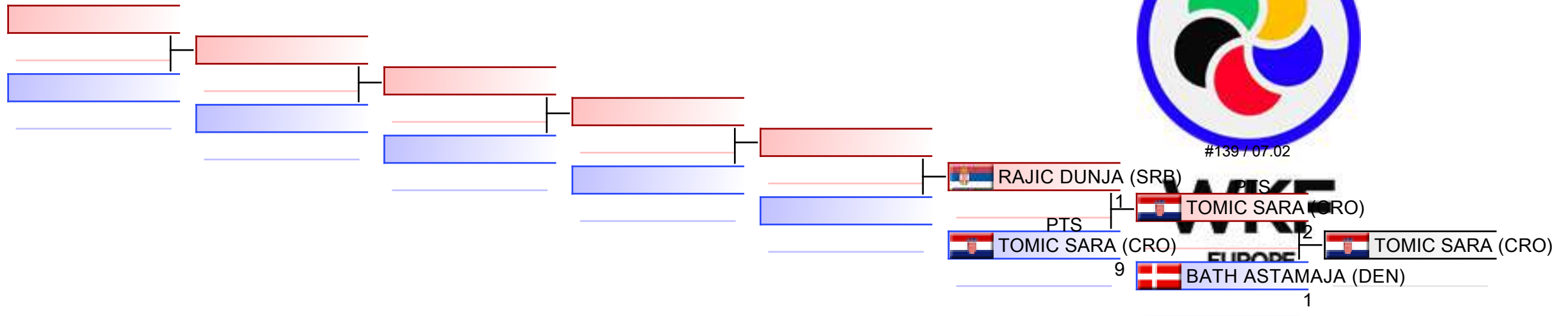

REPECHAGE: (1,2,3,4)

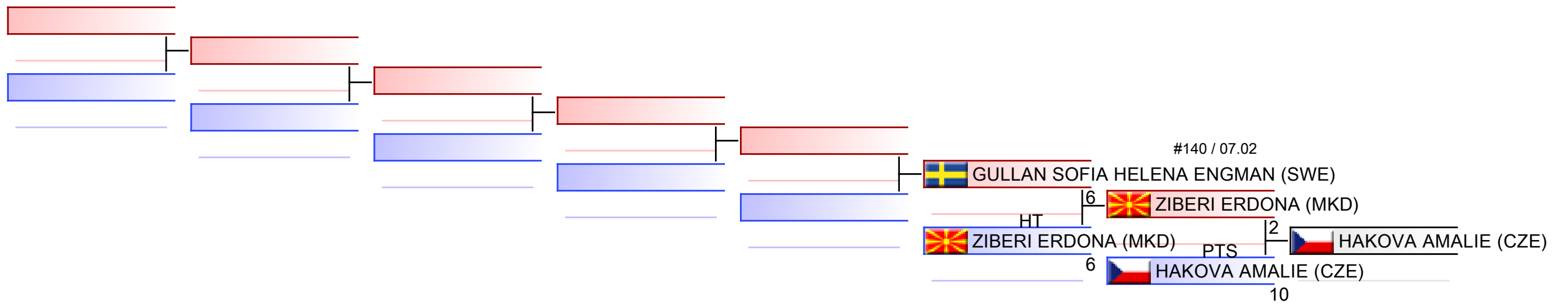

Referees:							
-----------	--	--	--	--	--	--	--



EKF Junior, Cadet & U21 Championships
2026 - Limassol - 2026-02-06



Official Results

U21 Kumite Female 68+ kg			
1	BULAY DARIIA		UKR - UKRAINE
2	FLEISCHER DORA		HUN - HUNGARY
3	TOMIC SARA		CRO - CROATIA
3	HAKOVA AMALIE		CZE - CZECH REPUBLIC
5	BATH ASTAMAJA		DEN - DENMARK
5	ZIBERI ERDONA		MKD - NORTH MACEDONIA
7	RAJIC DUNJA		SRB - SERBIA
7	GULLAN SOFIA HELENA ENGMAN		SWE - SWEDEN

U21 KUMITE MALE -60 KG



EKF Junior, Cadet & U21 Championships 2026 - Lim..



ENTRIES BY WEIGHT CATEGORY

U21 Kumite Male -60 kg

As of 8 FEB 2026

Code	ID	Gender	Name	Seeding
AUT	AUT02480	M	LANG MARCUS	
AZE	AZE02550	M	DOSTUYEV ASLAN	
BEL	BEL02291	M	ABDELMALKI AMIN	1
BIH	BIH2573	M	KADRIC FARUK	
BUL	BUL02471	M	STEFANOV NIKOLAY	
CRO	CRO2820	M	MASLOV LOVRO	
CYP	CYP2206	M	GAVRIEL ANDREAS	
CZE	CZE02348	M	LINHART JOSEF	
DEN	DEN02570	M	KALLESTRUP MARIUS	
ENG	ENG02903	M	YOGARAJAH KOBE	
ESP	ESP03305	M	PEREZ LORITE JORGE	
FRA	FRA02801	M	ERNWEIN THOMAS	
GEO	GEO02811	M	SUPATASHVILI NODARI	
GER	GER03121	M	OBITZ FLORIAN	
GRE	GRE2164	M	MERKOURIS THEODOROS	
IRL	IRL02840	M	KELLY TOMAS	
ISR	ISR02942	M	FILSHCHYNSKYI MARK	
ITA	ITA04271	M	SQUILLANTE GUIDO	
MKD	MKD03007	M	STOJCHEVSKI ANDREJ	
MLT	MLT02320	M	ATTARD JEREMY	
MNE	MNE2277	M	VOJINOVIC Balsa	4
POL	POL2694	M	WOJCIECHOWSKI KACPER	
POR	POR02709	M	OLIVEIRA GUSTAVO	2
ROU	ROU03765	M	TANASE ANDREI	
SCO	SCO02194	M	HAMILL ADAM	3
SRB	SRB02982	M	MILENKOVIC BOGDAN	
SUI	SUI02276	M	JOST RUBEN	
SVK	SD48713	M	CHRENKO JAN	
SWE	SWE02691	M	BECHTIOUI TAHA	
UKR	UKR003922	M	SOKHA NAZAR	
WKF-1	AIN-1006501	M	DMITRIEV VIACHESLAV	

U21 Kumite Male -60 kg

EKF Junior, Cadet & U21 Championships 2026 - Limassol, Spyros Kyprianou Athletic Center, Limassol, CYP

2026-02-07

Tatami
1 14:30

Pool
1/4



WKF
EUROPE

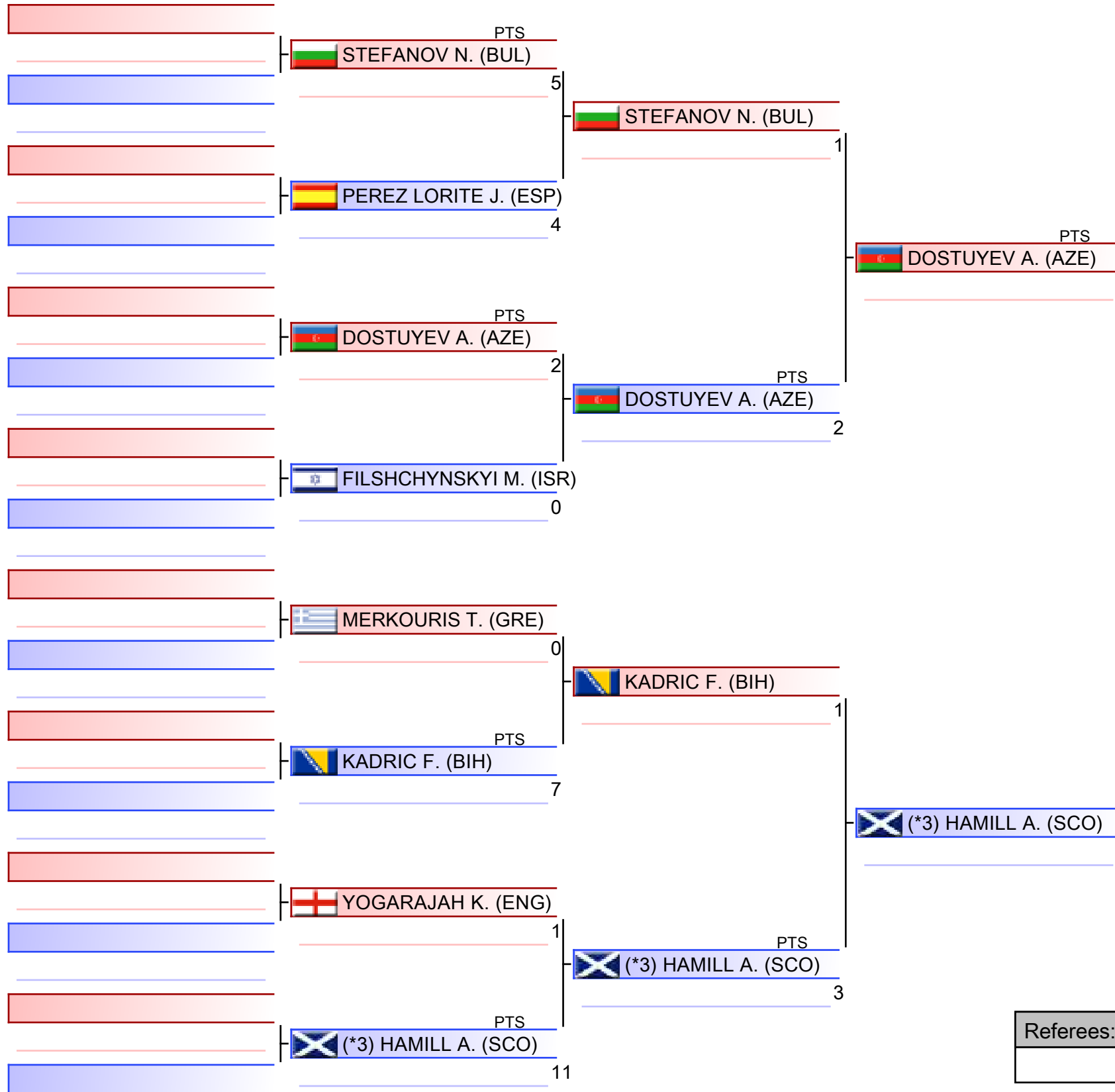

1. VOJINOVIC BALSA (MNE)
2. SQUILLANTE GUIDO (ITA)
3. ABDELMALKI AMIN (BEL)
3. DOSTUYEV ASLAN (AZE)
5. CHRENKO JAN (SVK)
5. OLIVEIRA GUSTAVO (POR)
7. KALLESTRUP MARIUS (DEN)
7. JOST RUBEN (SUI)

*Seeded

Referees:			

U21 Kumite Male -60 kg

EKF Junior, Cadet & U21 Championships 2026 - Limassol, Spyros Kyprianou Athletic Center, Limassol, CYP

2026-02-07

Tatami
1 15:15

Pool
2/4



WKF
EUROPE

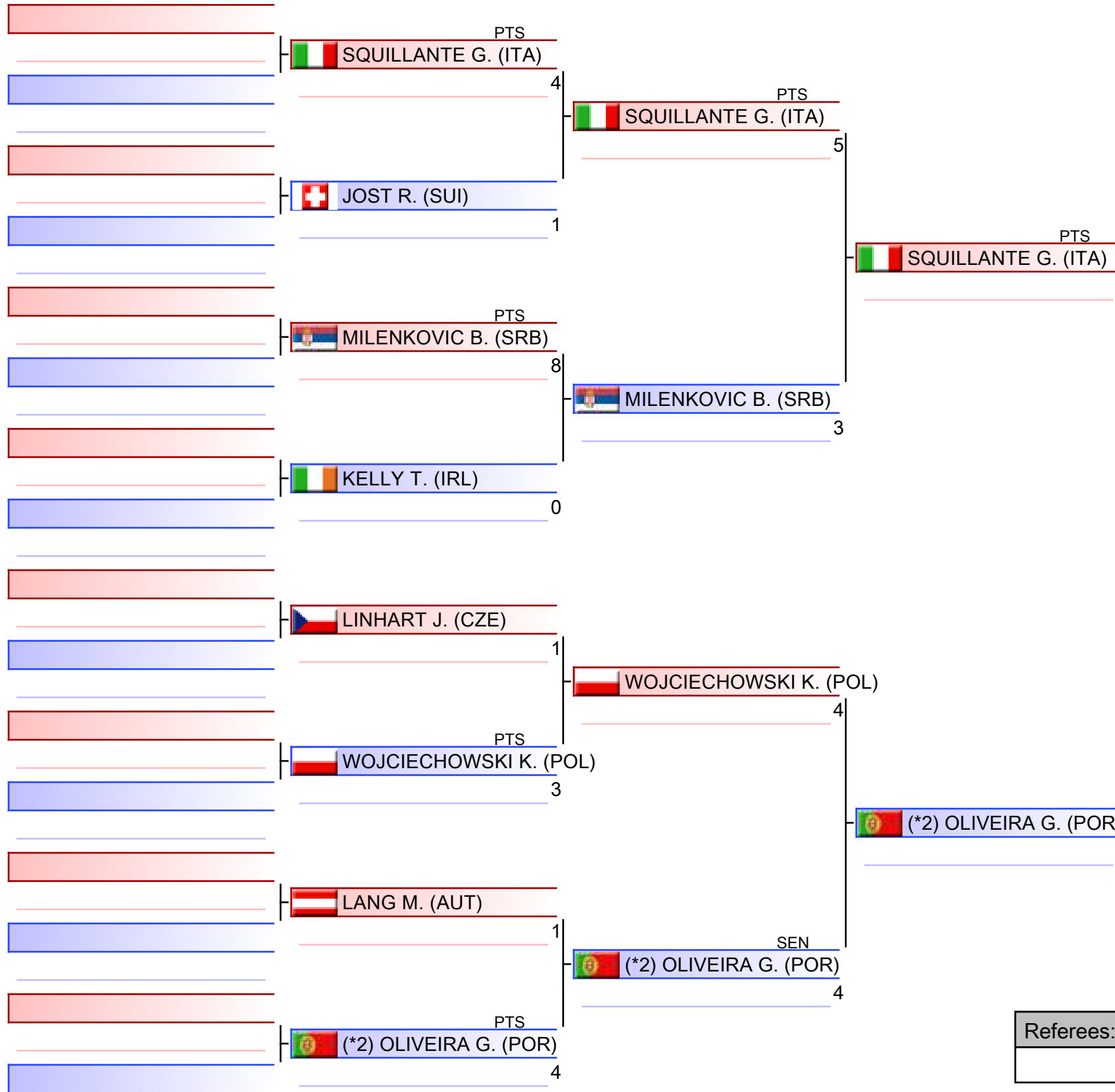

SQUILLANTE G. (ITA)

1. VOJINOVIC Balsa (MNE)
2. SQUILLANTE GUIDO (ITA)
3. ABDELMALKI AMIN (BEL)
3. DOSTUYEV ASLAN (AZE)
5. CHRENKO JAN (SVK)
5. OLIVEIRA GUSTAVO (POR)
7. KALLESTRUP MARIUS (DEN)
7. JOST RUBEN (SUI)

*Seeded

Referees:			

U21 Kumite Male -60 kg

EKF Junior, Cadet & U21 Championships 2026 - Limassol, Spyros Kyprianou Athletic Center, Limassol, CYP

2026-02-07

Tatami
2 14:20

Pool
3/4



WKF
EUROPE

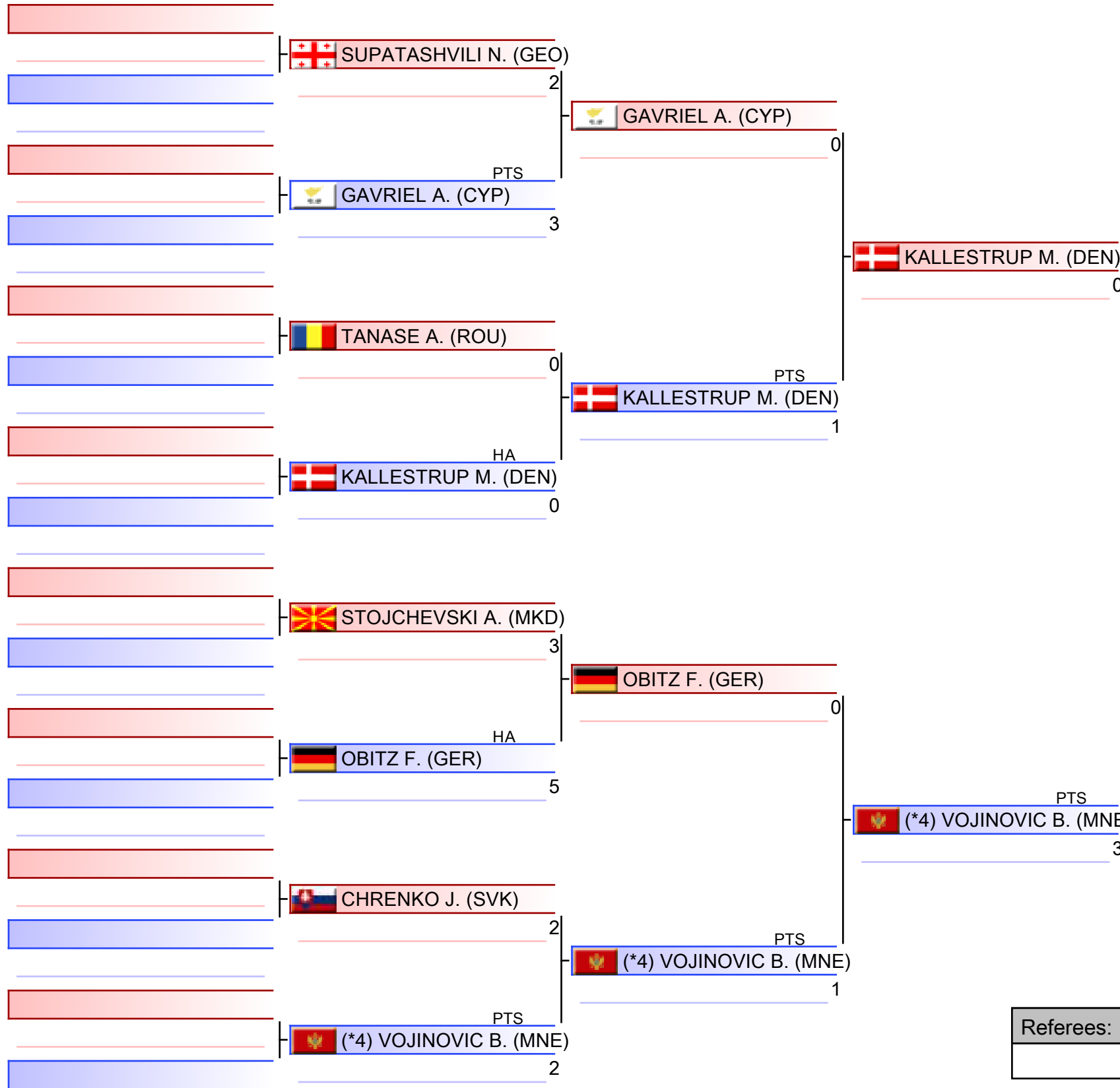

(*4) VOJINOVIC B. (MNE)

1. VOJINOVIC Balsa (MNE)
2. Squillante Guido (ITA)
3. Abdelmalki Amin (BEL)
3. Dostuyev Aslan (AZE)
5. Chrenko Jan (SVK)
5. Oliveira Gustavo (POR)
7. Kallestrup Marius (DEN)
7. Jost Ruben (SUI)

*Seeded

Referees:			

U21 Kumite Male -60 kg

EKF Junior, Cadet & U21 Championships 2026 - Limassol, Spyros Kyprianou Athletic Center, Limassol, CYP

2026-02-07

Tatami
2 15:05

Pool
4/4



WKF
EUROPE

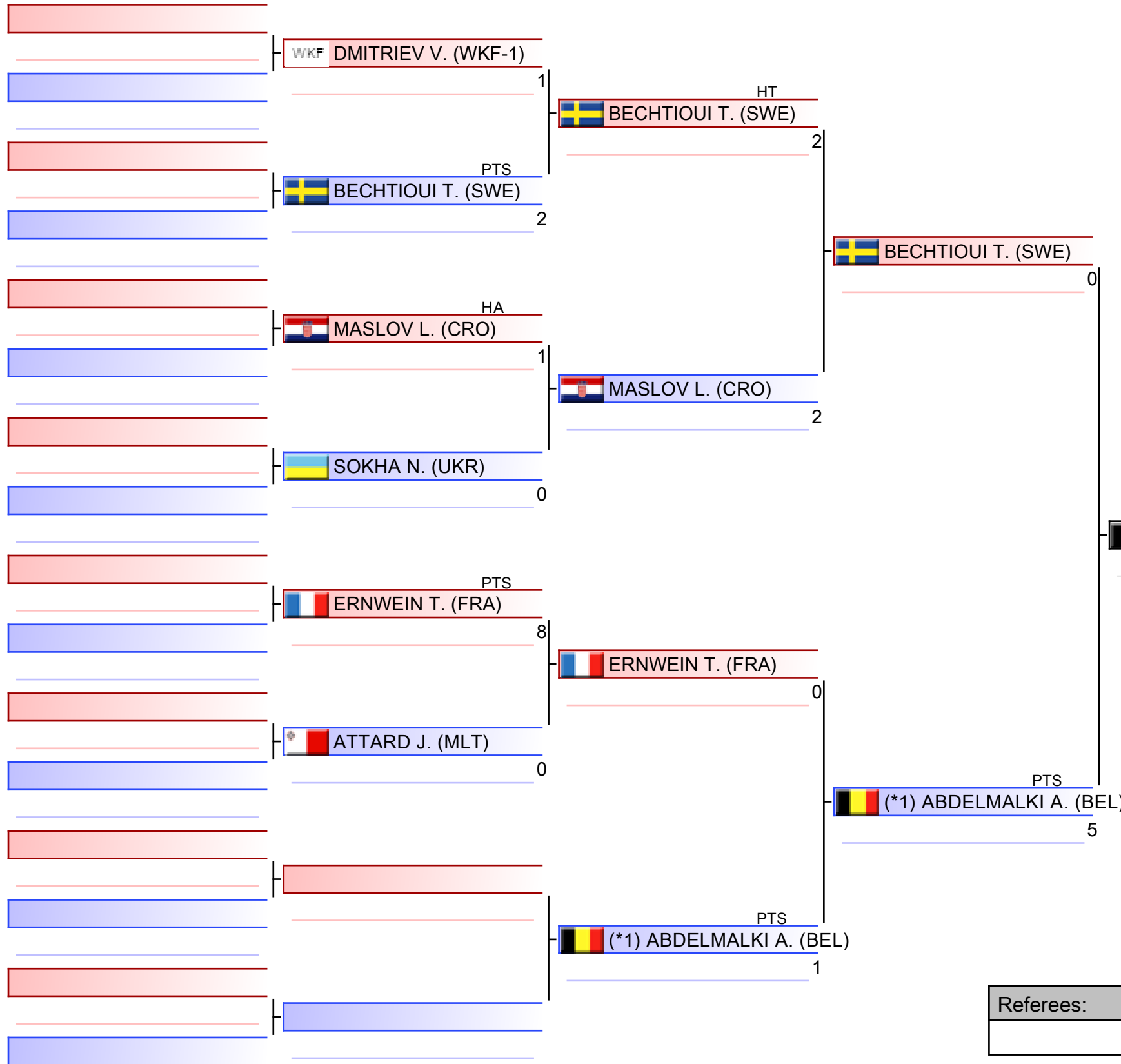

(*1) ABDELMALKI A. (BEL)

1. VOJINOVIC BALSA (MNE)
2. SQUILLANTE GUIDO (ITA)
3. ABDELMALKI AMIN (BEL)
3. DOSTUYEV ASLAN (AZE)
5. CHRENKO JAN (SVK)
5. OLIVEIRA GUSTAVO (POR)
7. KALLESTRUP MARIUS (DEN)
7. JOST RUBEN (SUI)

*Seeded

Referees:			

Pool winner-U21 Kumite Male -60 kg

EKF Junior, Cadet & U21 Championships 2026 - Limassol, Spyros Kyprianou Athletic Center, Limsassol, CYP

2026-02-07

Tatami
1 16:00

Pool
1/1



WKF
EUROPE

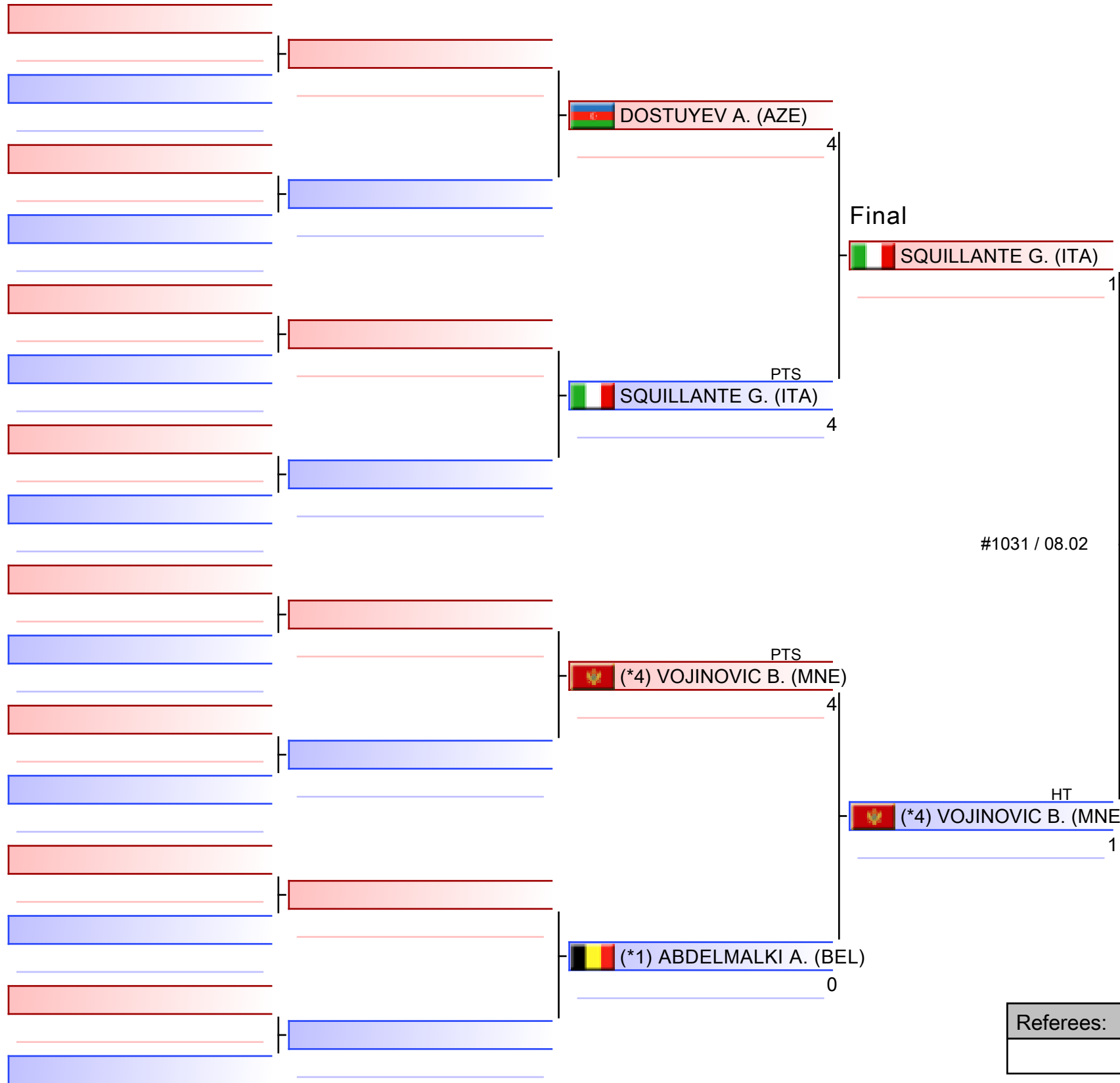

#1031 / 08.02

(*4) VOJINOVIC B. (MNE)

1. VOJINOVIC Balsa (MNE)
2. SQUILLANTE GUIDO (ITA)
3. ABDELMALKI AMIN (BEL)
3. DOSTUYEV ASLAN (AZE)
5. CHRENKO JAN (SVK)
5. OLIVEIRA GUSTAVO (POR)
7. KALLESTRUP MARIUS (DEN)
7. JOST RUBEN (SUI)

*Seeded

Referees:			

U21 Kumite Male -60 kg

EKF Junior, Cadet & U21 Championships 2026 - Limassol

2026-02-07

Tatami
3 18:25

Pool
1,2,3,4

(c)sportdata GmbH & Co KG 2000-2026 (2026-02-08 17:46) v 11.0.0 build 2 (2025-01-21 11:49 CET) License: SDIL TWG2025 (expire 2026-09-30)

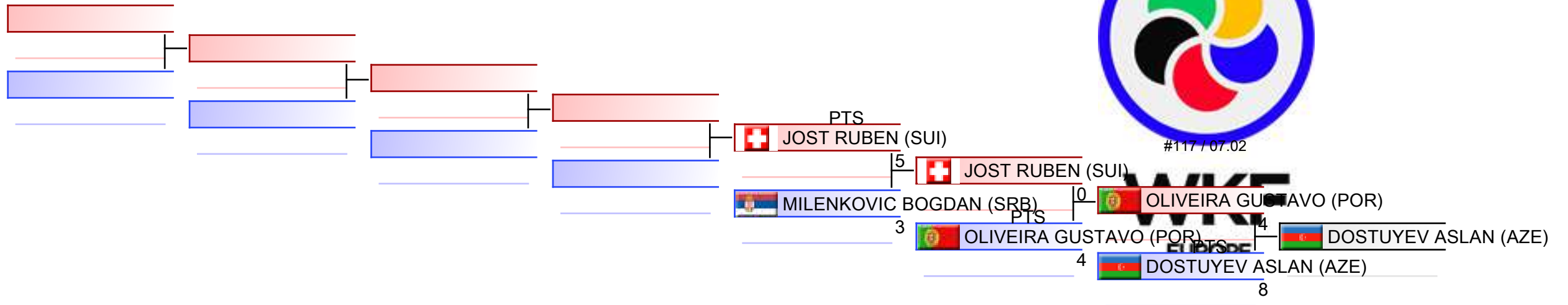

REPECHAGE: (1,2,3,4)

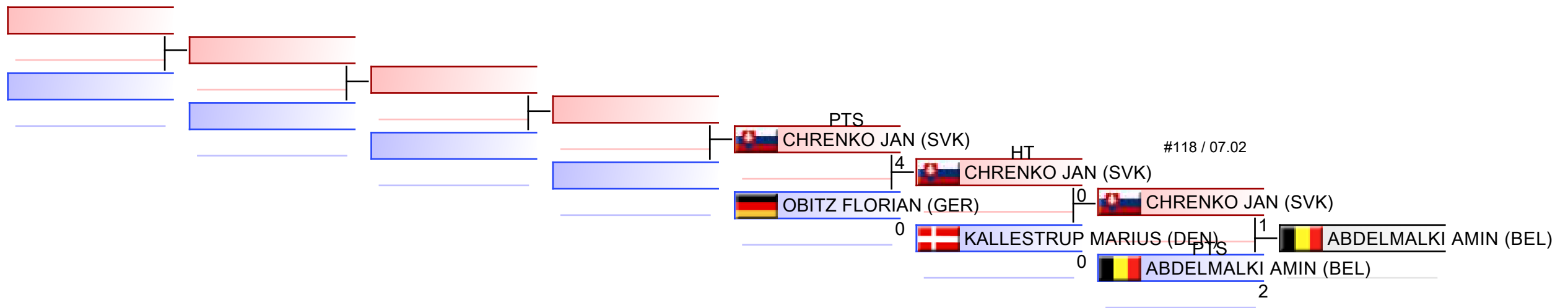

Referees:							
-----------	--	--	--	--	--	--	--



EKF Junior, Cadet & U21 Championships
2026 - Limassol - 2026-02-06



Official Results

U21 Kumite Male -60 kg			
1	VOJINOVIC BALSA		MNE - MONTENEGRO
2	SQUILLANTE GUIDO		ITA - ITALY
3	ABDELMALKI AMIN		BEL - BELGIUM
3	DOSTUYEV ASLAN		AZE - AZERBAIJAN
5	CHRENKO JAN		SVK - SLOVAKIA
5	OLIVEIRA GUSTAVO		POR - PORTUGAL
7	KALLESTRUP MARIUS		DEN - DENMARK
7	JOST RUBEN		SUI - SWITZERLAND
9	OBITZ FLORIAN		GER - GERMANY
9	MILENKOVIC BOGDAN		SRB - SERBIA

U21 KUMITE MALE -67 KG



EKF Junior, Cadet & U21 Championships 2026 - Lim..



ENTRIES BY WEIGHT CATEGORY

U21 Kumite Male -67 kg

As of 8 FEB 2026

Code	ID	Gender	Name	Seeding
ALB	ALB02464	M	RAMI RIGERS	
ARM	ARM02709	M	GEVORGYAN ALEN	
AZE	AZE02292	M	ALIRZAYEV SALMAN	
BEL	BEL02529	M	EJJA AMINE	4
BIH	BIH03169	M	JASAREVIC KERIM	
BUL	BUL2306	M	MIHAYLOV PETAR	
CRO	CRO03240	M	TUSKAN SVEN	
CYP	CYP2342	M	TSANGARAS ALEXIS	
CZE	CZE02481	M	DUB DANIEL	
DEN	DEN02456	M	KRISTENSEN HAILEMICHAEL	
ENG	ENG02909	M	BARTOLETTA DANIEL	
ESP	ESP02880	M	PIRIS FERRER MIGUEL	
FRA	FRA004200	M	BETTACHE YASIN	
GEO	GEO02670	M	KUZANASHVILI LUKA	
GER	GER03357	M	SAFI HEIDAR	
GRE	GRE02321	M	BALLOTIS GEORGIOS	2
HUN	HUN02532	M	TOTH ZSOMBOR	
IRL	IRL02798	M	KELLY CATHAL	
ISR	ISR02941	M	BAR MASHIAH SHAKED	
ITA	ITA04234	M	GIORDANO FABRIZIO	
LUX	LUX02193	M	SIBILLE JORDAN	3
MDA	MDA02267	M	CAPMOALE ALEXANDR	
MKD	MKD2418	M	BELISTOJANOSKI MATEJ	
MNE	MNE2272	M	DJURCEVIC LAZAR	
NED	NED02694	M	ACHGHOUYAB SAMY	
NOR	NOR02484	M	BERG-ALSTADSAETER PEDER XINGE	
POL	POL2485	M	DZIUDA DOMINIK	
POR	POR02720	M	GONCALVES GUILHERME	1
ROU	ROU02831	M	IANCU DAVID ADRIAN	
SCO	SCO02404	M	GALLAGHER JOE	
SLO	SLO2427	M	ZARIC VID	
SRB	SRB03007	M	VUCKOVIC ALEKSANDAR	
SUI	SUI02269	M	LORENZ SWAN	
SVK	SVK02653	M	IVANCIK OLIVER	
SWE	SWE003122	M	NASER AHMED	
UKR	UKR03066	M	PRANNYCHUK NAZARII	
WKF-1	AIN-1006496	M	KEBISHEV ISLAM	
WKF-2	AIN-2002777	M	BAHAMOLETS MIKITA	

U21 Kumite Male -67 kg

EKF Junior, Cadet & U21 Championships 2026 - Limassol, Spyros Kyprianou Athletic Center, Limassol, CYP

2026-02-07

Tatami
3 14:45

Pool
1/4

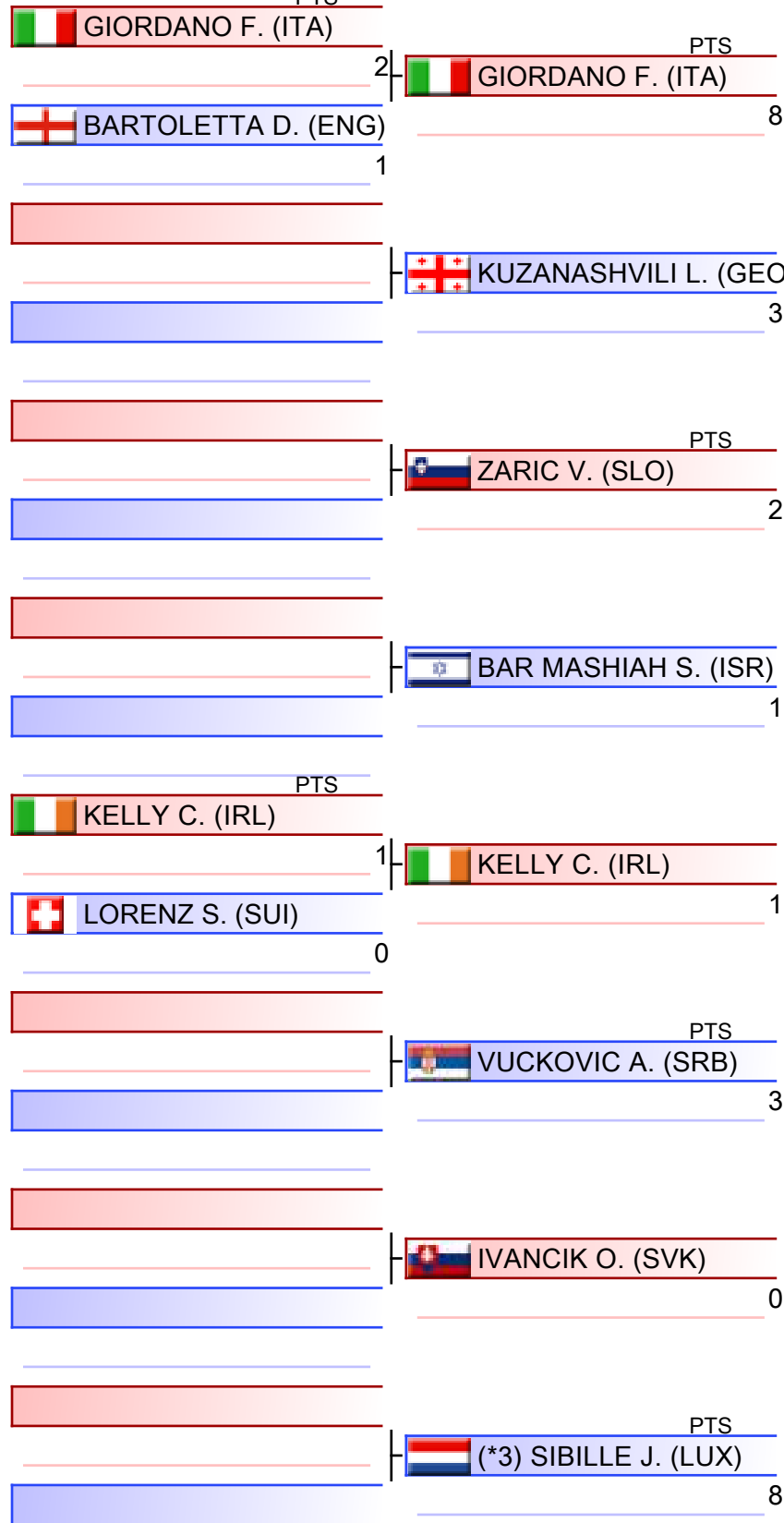

GIORDANO F. (ITA)

1. BELISTOJANOSKI MATEJ (MKD)
2. BALIOTIS GEORGIOS (GRE)
3. GALLAGHER JOE (SCO)
3. TOTH ZSOMBOR (HUN)
5. PRANNYCHUK NAZARIJ (UKR)
5. GIORDANO FABRIZIO (ITA)
7. EJJA AMINE (BEL)
7. DJURCEVIC LAZAR (MNE)

*Seeded

Referees:			

U21 Kumite Male -67 kg

EKF Junior, Cadet & U21 Championships 2026 - Limassol, Spyros Kyprianou Athletic Center, Limassol, CYP

2026-02-07

Tatami
3 15:40

Pool
2/4

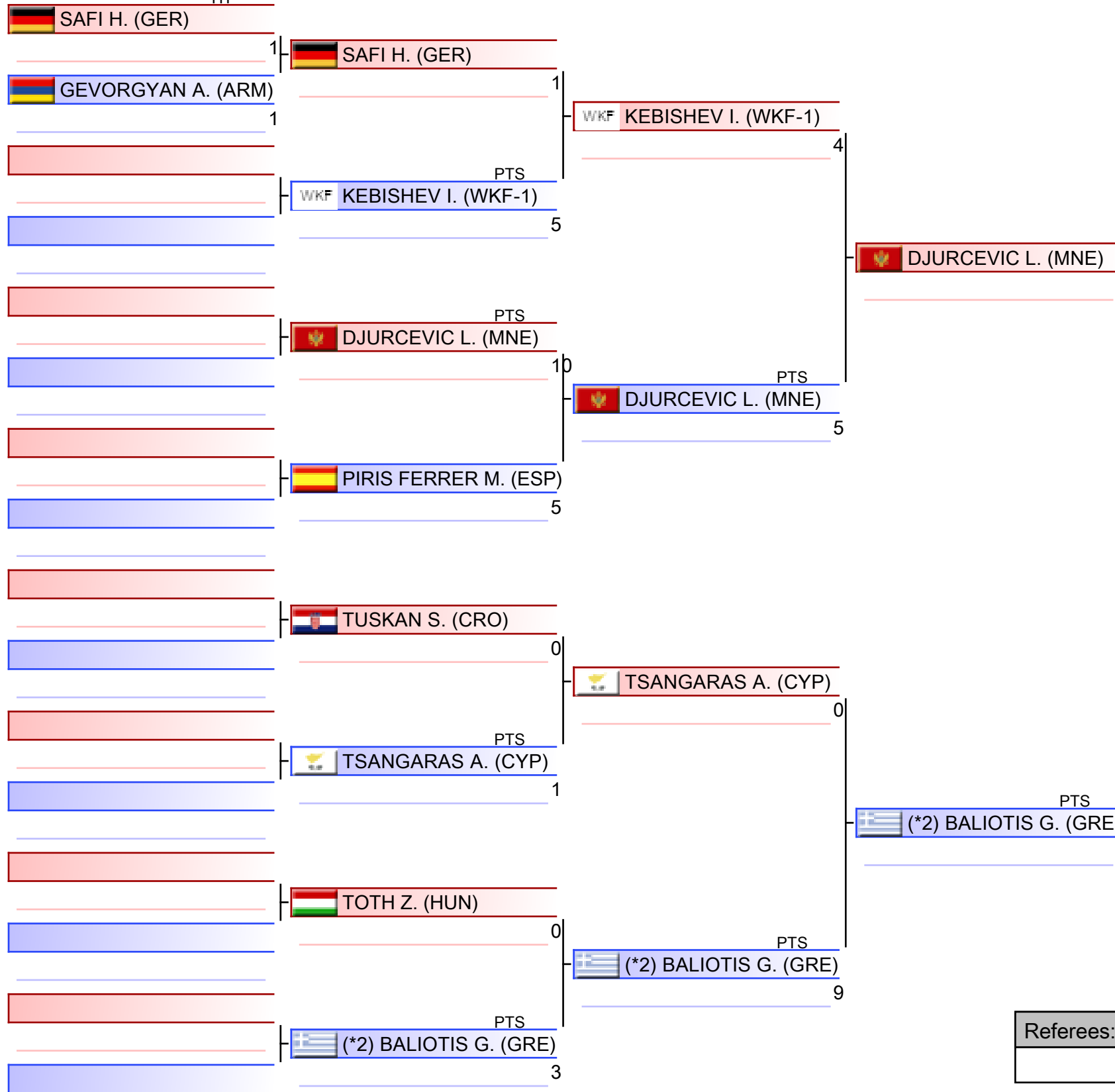

(*2) BALIOTIS G. (GRE)

1. BELISTOJANOSKI MATEJ (MKD)
2. BALIOTIS GEORGIOS (GRE)
3. GALLAGHER JOE (SCO)
3. TOTH ZSOMBOR (HUN)
5. PRANNYCHUK NAZARII (UKR)
5. GIORDANO FABRIZIO (ITA)
7. EJJA AMINE (BEL)
7. DJURCEVIC LAZAR (MNE)

*Seeded

Referees:			

U21 Kumite Male -67 kg

EKF Junior, Cadet & U21 Championships 2026 - Limassol, Spyros Kyprianou Athletic Center, Limassol, CYP

2026-02-07

Tatami
4 14:40

Pool
3/4

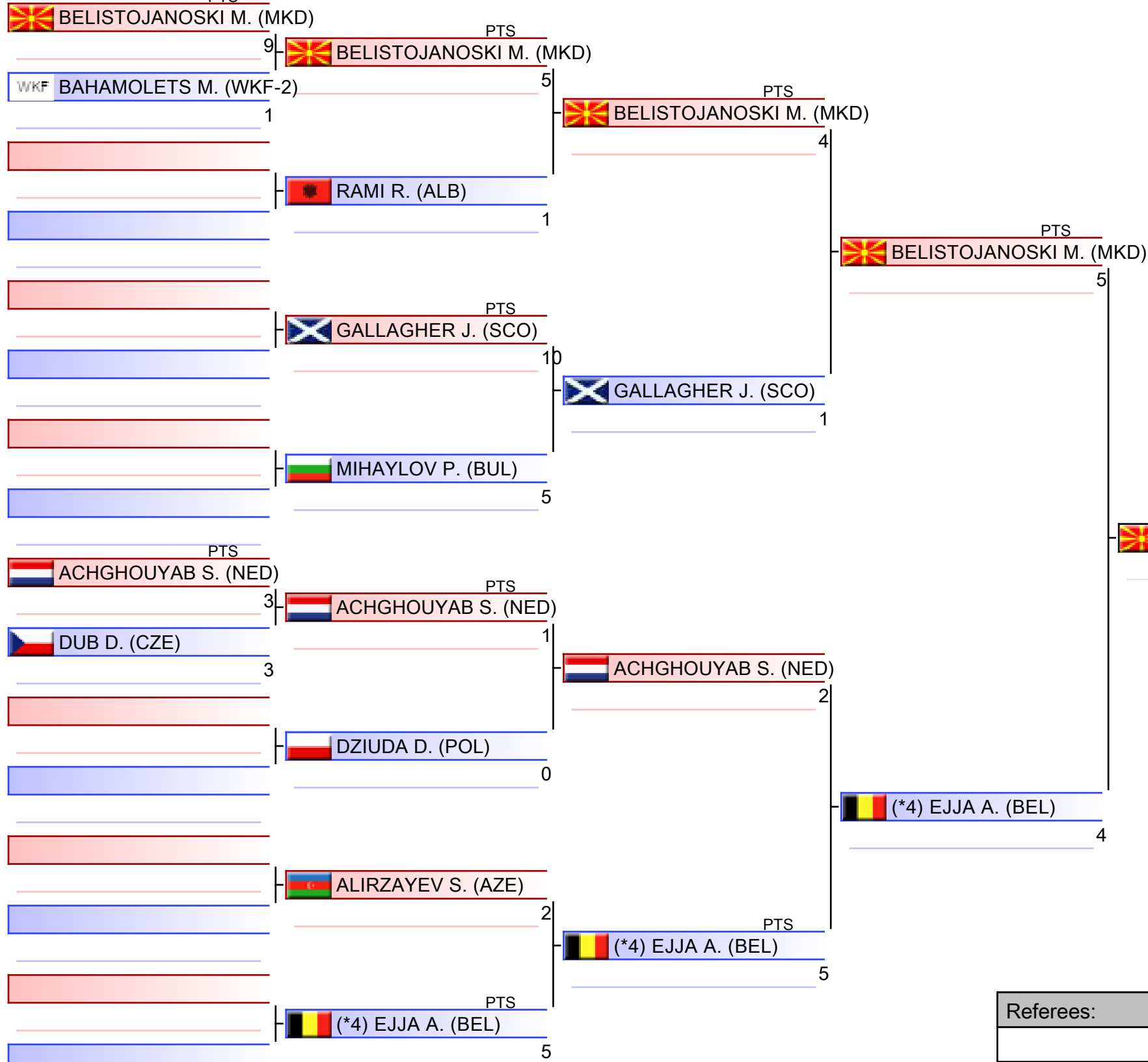

WKF
EUROPE

1. BELISTOJANOSKI MATEJ (MKD)
2. BALIOTIS GEORGIOS (GRE)
3. GALLAGHER JOE (SCO)
3. TOTH ZSOMBOR (HUN)
5. PRANNYCHUK NAZARII (UKR)
5. GIORDANO FABRIZIO (ITA)
7. EJJA AMINE (BEL)
7. DJURCEVIC LAZAR (MNE)

*Seeded

Referees:			

U21 Kumite Male -67 kg

EKF Junior, Cadet & U21 Championships 2026 - Limassol, Spyros Kyprianou Athletic Center, Limassol, CYP

2026-02-07

Tatami
4 15:35

Pool
4/4

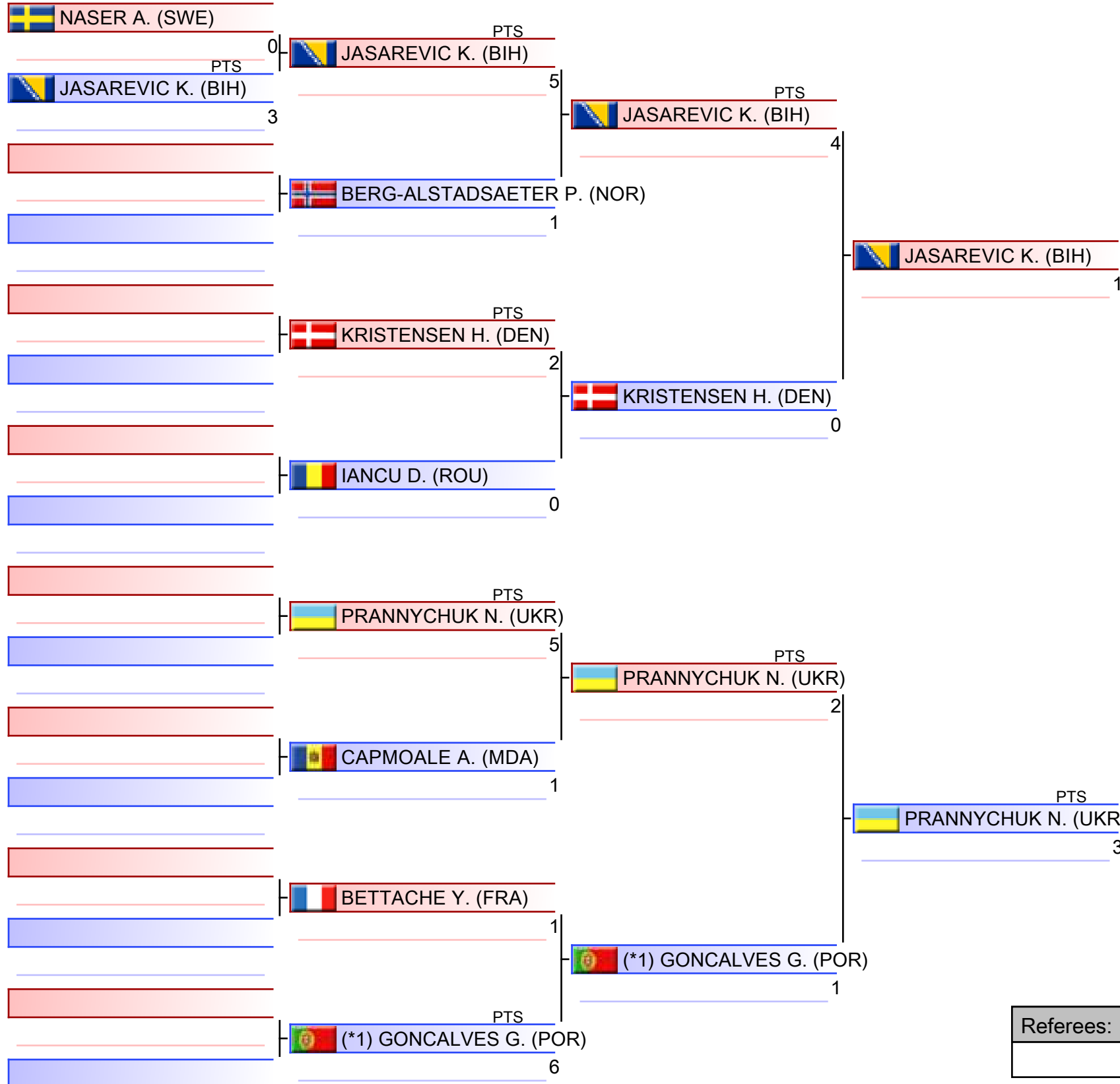

WKF
EUROPE

PRANNYCHUK N. (UKR)

1. BELISTOJANOSKI MATEJ (MKD)
2. BALIOTIS GEORGIOS (GRE)
3. GALLAGHER JOE (SCO)
3. TOTH ZSOMBOR (HUN)
5. PRANNYCHUK NAZARII (UKR)
5. GIORDANO FABRIZIO (ITA)
7. EJJA AMINE (BEL)
7. DJURCEVIC LAZAR (MNE)

*Seeded

Referees:			

Pool winner-U21 Kumite Male -67 kg

EKF Junior, Cadet & U21 Championships 2026 - Limassol, Spyros Kyprianou Athletic Center, Limassol, CYP

2026-02-07

Tatami
3 16:30

Pool
1/1



WKF
EUROPE

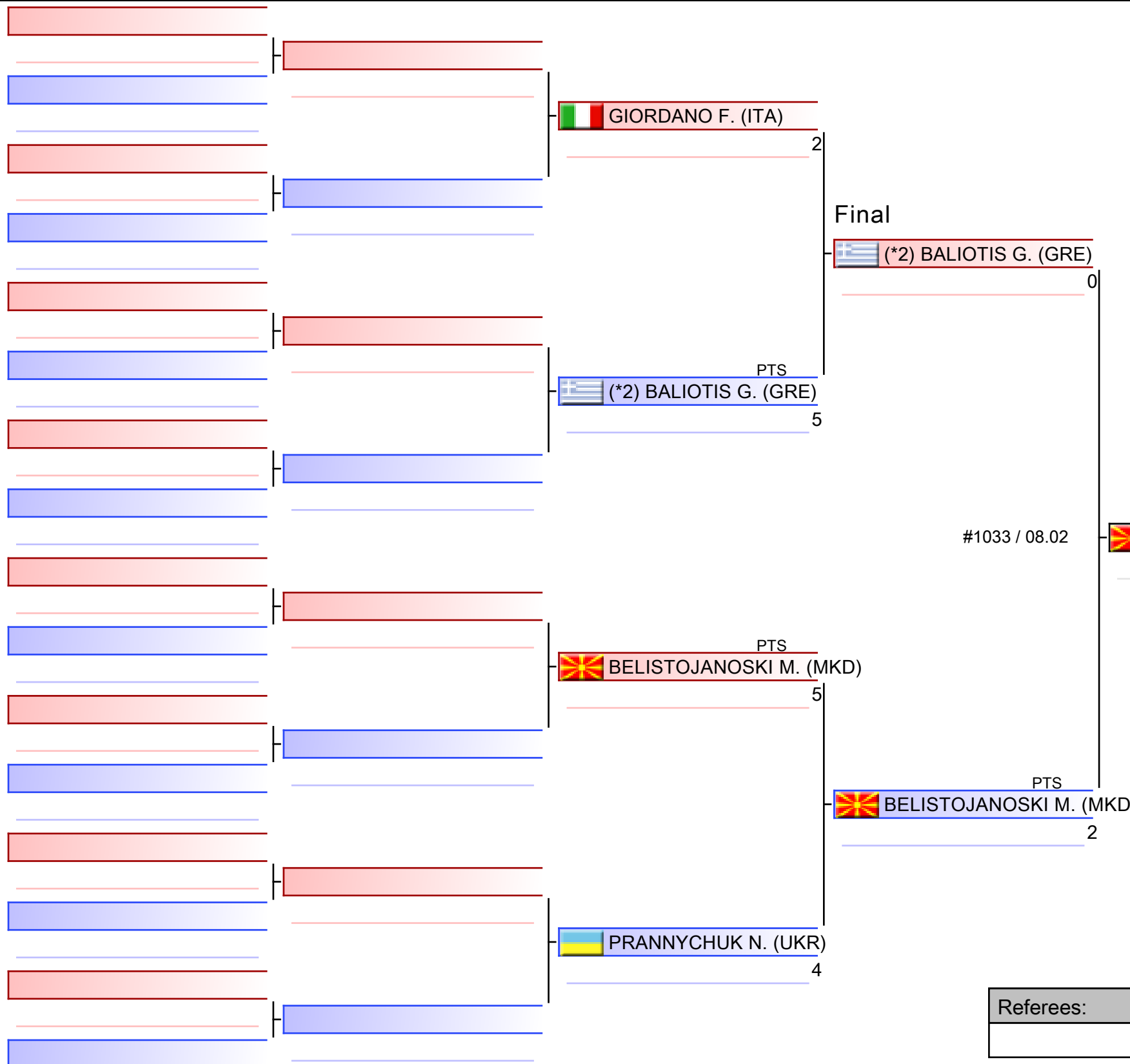

1. BELISTOJANOSKI MATEJ (MKD)
2. BALIOTIS GEORGIOS (GRE)
3. GALLAGHER JOE (SCO)
3. TOTH ZSOMBOR (HUN)
5. PRANNYCHUK NAZARII (UKR)
5. GIORDANO FABRIZIO (ITA)
7. EJJA AMINE (BEL)
7. DJURCEVIC LAZAR (MNE)

*Seeded

Referees:			

U21 Kumite Male -67 kg

EKF Junior, Cadet & U21 Championships 2026 - Limassol

2026-02-07

Tatami

1 18:20

Pool

1,2,3,4

(c)sportdata GmbH & Co KG 2000-2026 (2026-02-08 17:46) v 11.0.0 build 2 (2025-01-21 11:49 CET) License: SDIL TWG2025 (expire 2026-09-30)

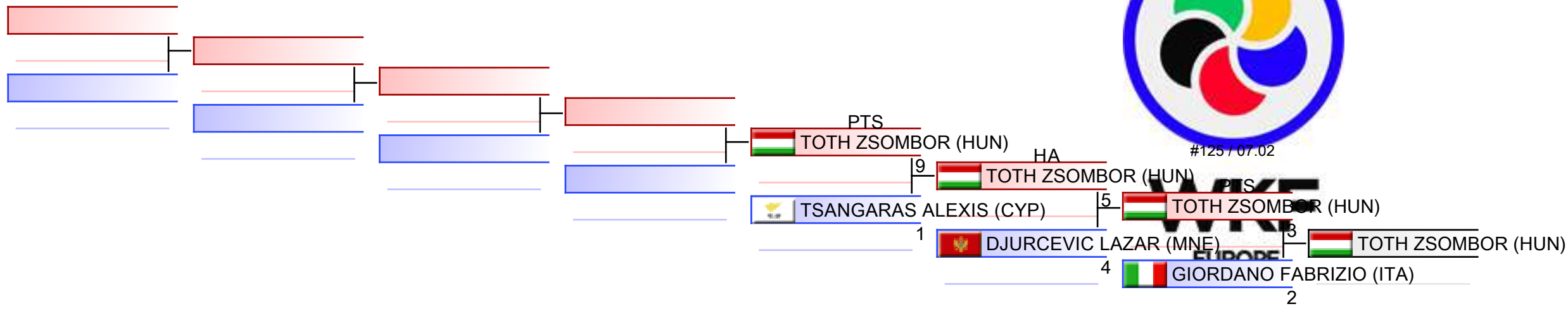

REPECHAGE: (1,2,3,4)

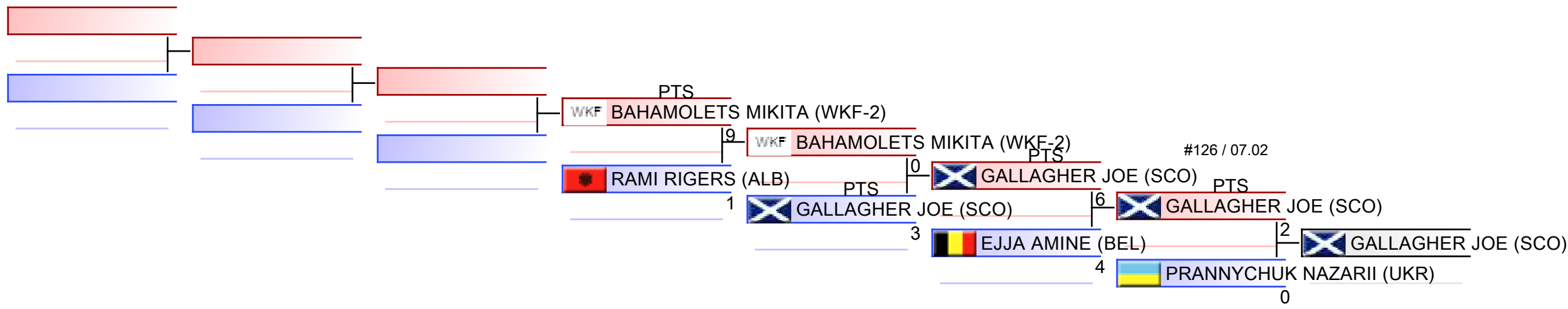

Referees:							
-----------	--	--	--	--	--	--	--



EKF Junior, Cadet & U21 Championships
2026 - Limassol - 2026-02-06



Official Results

U21 Kumite Male -67 kg			
1	BELISTOJANOSKI MATEJ		MKD - NORTH MACEDONIA
2	BALLOTIS GEORGIOS		GRE - GREECE
3	GALLAGHER JOE		SCO - SCOTLAND
3	TOTH ZSOMBOR		HUN - HUNGARY
5	PRANNYCHUK NAZARII		UKR - UKRAINE
5	GIORDANO FABRIZIO		ITA - ITALY
7	EJJA AMINE		BEL - BELGIUM
7	DJURCEVIC LAZAR		MNE - MONTENEGRO
9	BAHAMOLETS MIKITA		WKF-2 - WKF-2
9	TSANGARAS ALEXIS		CYP - CYPRUS
11	RAMI RIGERS		ALB - ALBANIA

U21 KUMITE MALE -75 KG



EKF Junior, Cadet & U21 Championships 2026 - Lim..



ENTRIES BY WEIGHT CATEGORY

U21 Kumite Male -75 kg

As of 8 FEB 2026

Code	ID	Gender	Name	Seeding
AUT	AUT003240	M	HRIHORASHENKO MYKYTA	
AZE	AZE02553	M	AZIM RAHIB	
BEL	BEL02794	M	ZEKHNINI ACHRAF	
BIH	BIH2823	M	ZOLOTA ISMAIL	3
BUL	BUL2222	M	TODOROV ISKREN	
CRO	CRO2660	M	STRAHIJA SVEN	
CYP	CYP2336	M	CHARALAMBIDES STAVROS ALEXANDROS	
CZE	CZE02738	M	SNAJDR STEPAN	
DEN	DEN02642	M	KJAER POULSEN ALVIN	
ENG	ENG03248	M	COOPER-DALLEY JOSEPH	
ESP	ESP02554	M	SHOTTE CABELLO ZSAMORAN	
EST	EST002740	M	BOKOV ROLAN	
FRA	FRA03068	M	CISSOKHO ISMAILA	
GEO	GEO02558	M	DONADZE ANZOR	
GER	GER003925	M	RAISWICH ROMAN	
GRE	GRE03105	M	GIANNAKIS MARIOS	
HUN	HUN02531	M	TOTH MATE	
IRL	IRL02799	M	AINSCOUGH LEE	
ITA	ITA03876	M	IANNUZZI MARIO	2
LAT	LAT2213	M	KALVANS DENISS	
MDA	MDA02375	M	GUZUN DAN	
MKD	MKD2290	M	MIHAJLOV LJUPCHE	4
MNE	MNE2265	M	ZEJAK NIKSA	
NED	NED02684	M	FRANKEN RICARDO	
POL	POL2493	M	FIEREK JAN	
POR	POR02479	M	ALEXANDRE CARDOSO INACIO DIOGO	
ROU	ROU02985	M	BUDAN PIRVU PATRICK ALEX	
SCO	SCO02200	M	PACKWOOD BENJAMIN	
SLO	SLO2443	M	ZIBRET BOR	
SRB	SRB004825	M	MARIC DANILO	
SUI	SUI02682	M	KABASHI ELSON JASON	
SVK	SVK02501	M	SECKAR SIMON	
UKR	UKR02683	M	PITSUL HEORHII	1
WKF-1	RUS04506	M	GADZHIEV GADZHI	

U21 Kumite Male -75 kg

EKF Junior, Cadet & U21 Championships 2026 - Limassol, Spyros Kyprianou Athletic Center, Limassol, CYP

2026-02-07

Tatami
5 14:35

Pool
1/4

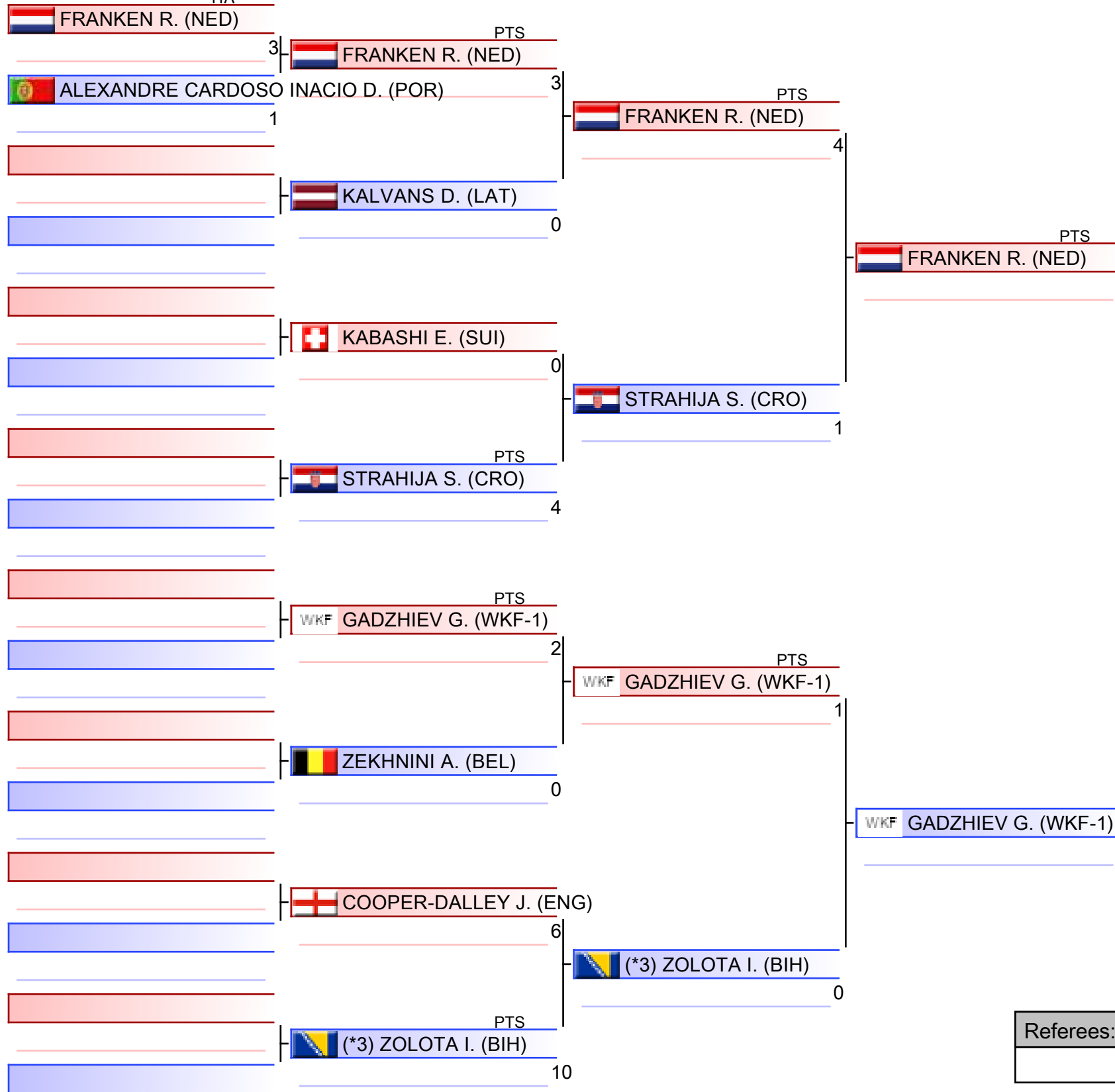

WKF
EUROPE

1. SECKAR SIMON (SVK)
2. FRANKEN RICARDO (NED)
3. PITSUL HEORHII (UKR)
3. GADZHIEV GADZHI (WKF-1)
5. SHOTTE CABELLO ZSAMORAN (ESP)
5. HRIHORASHENKO MYKYTA (AUT)
7. MIHAJLOV LJUPCHE (MKD)
7. STRAHIIJA SVEN (CRO)

*Seeded

Referees:			

U21 Kumite Male -75 kg

EKF Junior, Cadet & U21 Championships 2026 - Limassol, Spyros Kyprianou Athletic Center, Limassol, CYP

2026-02-07

Tatami
5 15:25

Pool
2/4



WKF
EUROPE

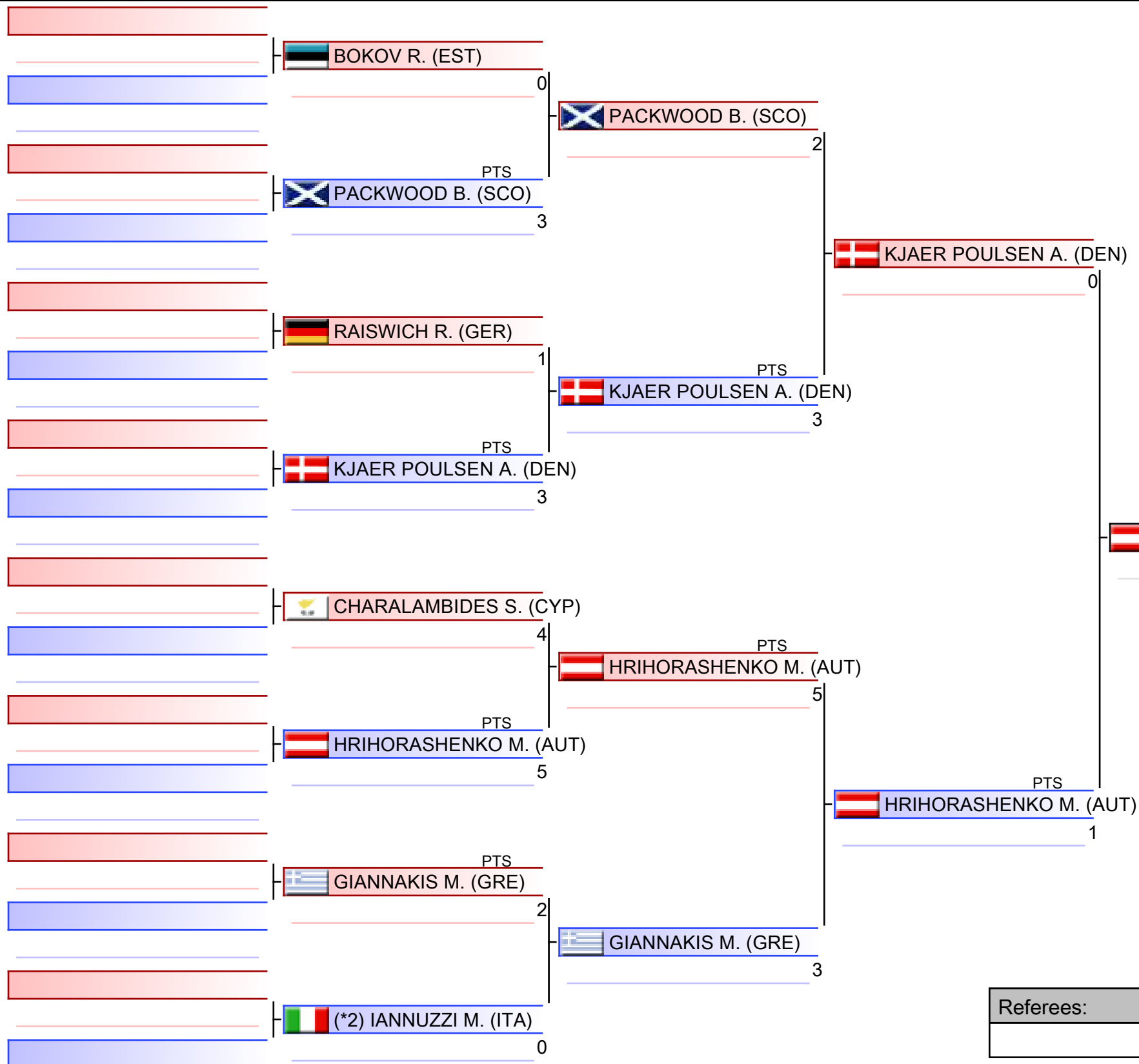

HRIHORASHENKO M. (AUT)

1. SECKAR SIMON (SVK)
2. FRANKEN RICARDO (NED)
3. PITSUL HEORHII (UKR)
3. GADZHIEV GADZHI (WKF-1)
5. SHOTTE CABELLO ZSAMORAN (ESP)
5. HRIHORASHENKO MYKYTA (AUT)
7. MIHAJLOV LJUPCHE (MKD)
7. STRAHIJA SVEN (CRO)

*Seeded

Referees:			

U21 Kumite Male -75 kg

EKF Junior, Cadet & U21 Championships 2026 - Limassol, Spyros Kyprianou Athletic Center, Limassol, CYP

2026-02-07

Tatami
6 14:25

Pool
3/4

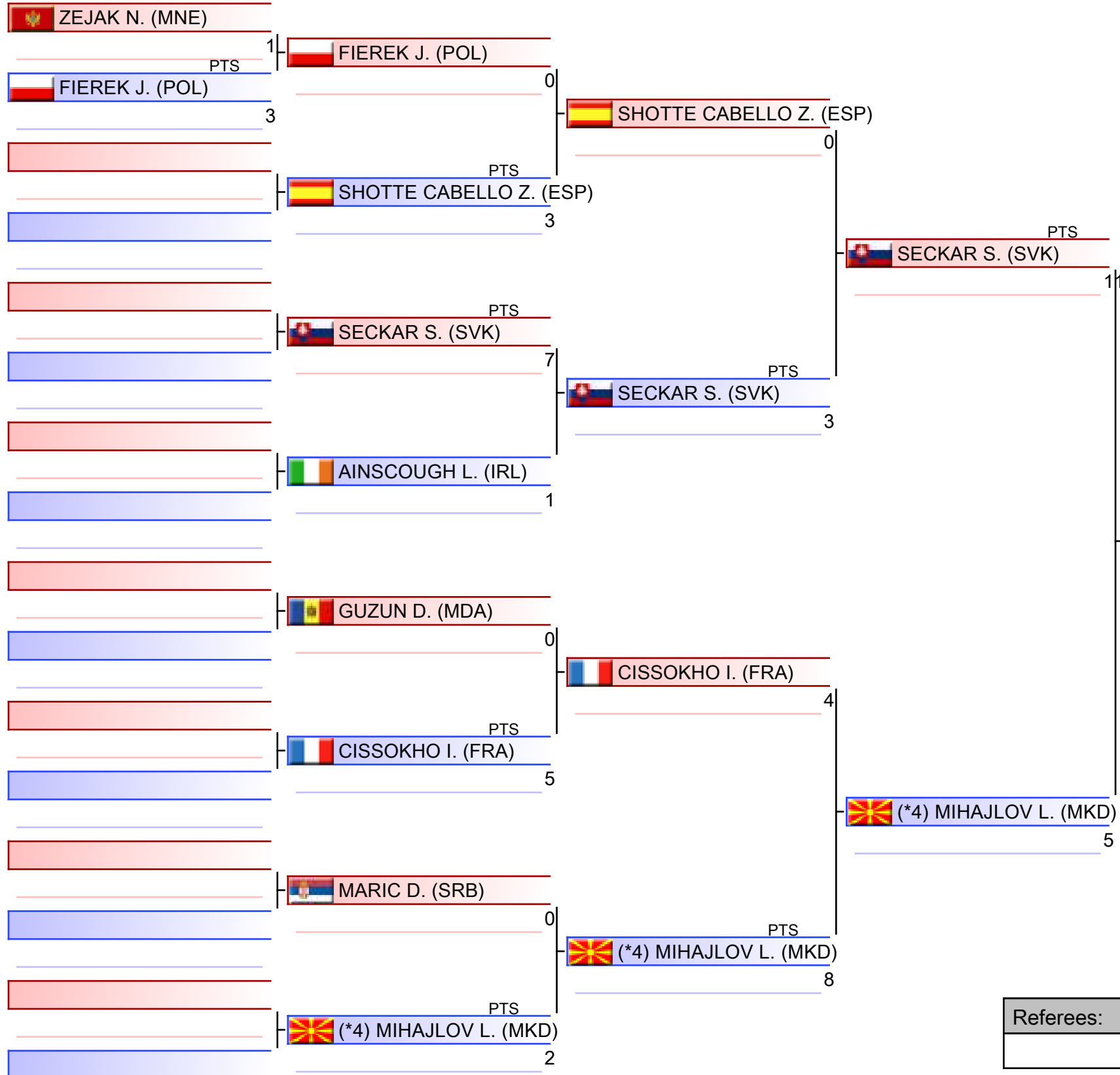

WKF
EUROPE

1. SECKAR SIMON (SVK)
2. FRANKEN RICARDO (NED)
3. PITSUL HEORHII (UKR)
3. GADZHIEV GADZHI (WKF-1)
5. SHOTTE CABELLO ZSAMORAN (ESP)
5. HRIHORASHENKO MYKYTA (AUT)
7. MIHAJLOV LJUPCHE (MKD)
7. STRAHIJA SVEN (CRO)

*Seeded

Referees:			

U21 Kumite Male -75 kg

EKF Junior, Cadet & U21 Championships 2026 - Limassol, Spyros Kyprianou Athletic Center, Limassol, CYP

2026-02-07

Tatami
6 15:15

Pool
4/4



WKF
EUROPE

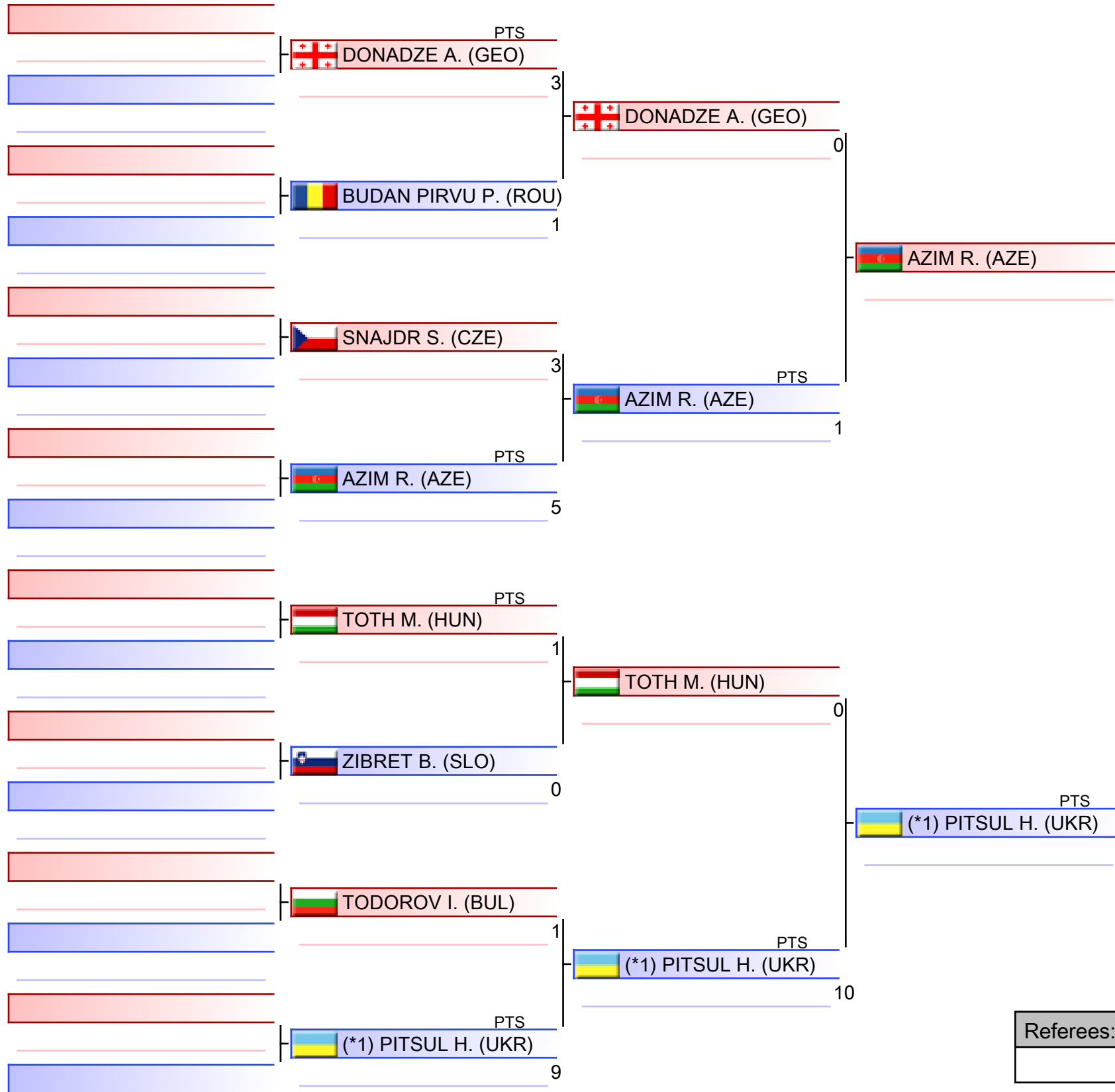

(*1) PITSUL H. (UKR)

1. SECKAR SIMON (SVK)
2. FRANKEN RICARDO (NED)
3. PITSUL HEORHII (UKR)
3. GADZHIEV GADZHI (WKF-1)
5. SHOTTE CABELLO ZSAMORAN (ESP)
5. HRIHORASHENKO MYKYTA (AUT)
7. MIHAJLOV LJUPCHE (MKD)
7. STRAHIJA SVEN (CRO)

*Seeded

Referees:			

Pool winner-U21 Kumite Male -75 kg

EKF Junior, Cadet & U21 Championships 2026 - Limassol, Spyros Kyprianou Athletic Center, Limsassol, CYP

2026-02-07

Tatami
5 16:10

Pool
1/1



WKF
EUROPE

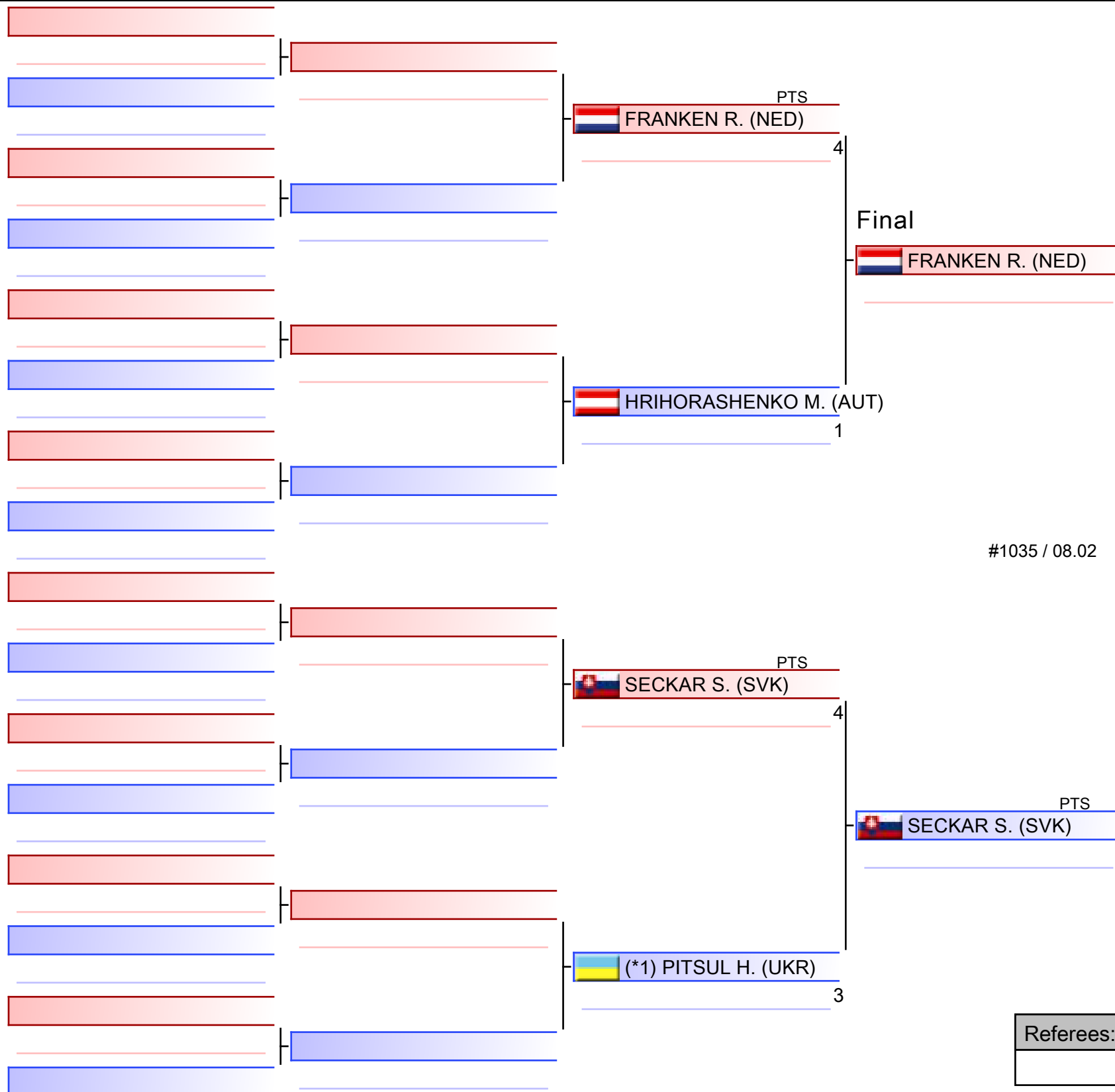

1. SECKAR SIMON (SVK)
2. FRANKEN RICARDO (NED)
3. PITSUL HEORHII (UKR)
3. GADZHIEV GADZHI (WKF-1)
5. SHOTTE CABELLO ZSAMORAN (ESP)
5. HRIHORASHENKO MYKYTA (AUT)
7. MIHAJLOV LJUPCHE (MKD)
7. STRAHIJA SVEN (CRO)

*Seeded

Referees:			

U21 Kumite Male -75 kg

EKF Junior, Cadet & U21 Championships 2026 - Limassol

2026-02-07

Tatami
4 18:25

Pool
1,2,3,4

(c)sportdata GmbH & Co KG 2000-2026 (2026-02-08 17:46) v 11.0.0 build 2 (2025-01-21 11:49 CET) License: SDIL TWG2025 (expire 2026-09-30)



#123 / 07.02

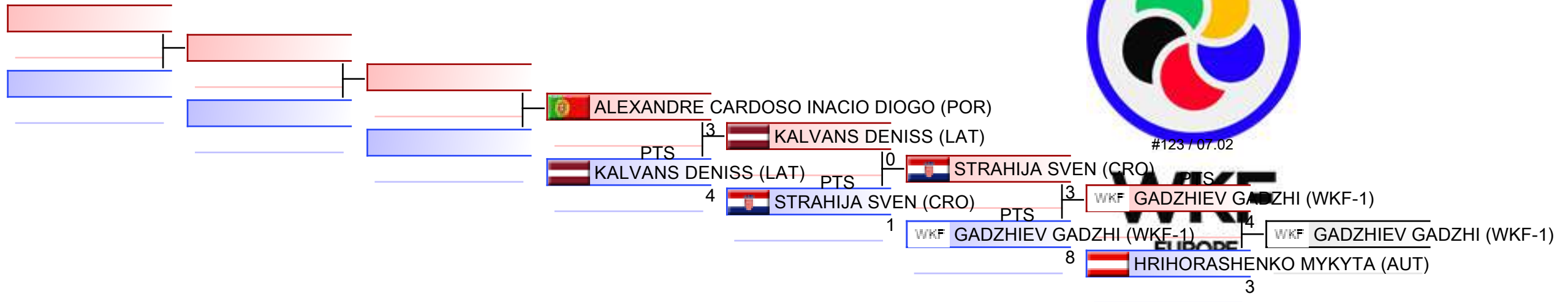

REPECHAGE: (1,2,3,4)

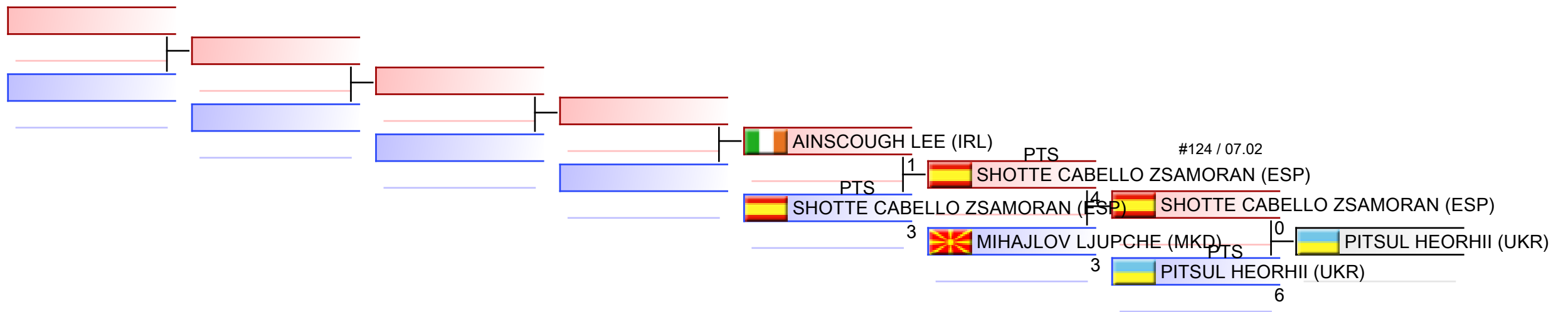

Referees:							
-----------	--	--	--	--	--	--	--



EKF Junior, Cadet & U21 Championships
2026 - Limassol - 2026-02-06



Official Results

U21 Kumite Male -75 kg			
1	SECKAR SIMON		SVK - SLOVAKIA
2	FRANKEN RICARDO		NED - NETHERLANDS
3	PITSUL HEORHII		UKR - UKRAINE
3	GADZHIEV GADZHI		WKF-1 - WKF-1
5	SHOTTE CABELLO ZSAMORAN		ESP - SPAIN
5	HRIHORASHENKO MYKYTA		AUT - AUSTRIA
7	MIHAJLOV LJUPCHE		MKD - NORTH MACEDONIA
7	STRAHIJA SVEN		CRO - CROATIA
9	AINSCOUGH LEE		IRL - IRELAND
9	KALVANS DENISS		LAT - LATVIA
11	ALEXANDRE CARDOSO INACIO DIOGO		POR - PORTUGAL

U21 KUMITE MALE -84 KG



EKF Junior, Cadet & U21 Championships 2026 - Lim..



ENTRIES BY WEIGHT CATEGORY

U21 Kumite Male -84 kg

As of 8 FEB 2026

Code	ID	Gender	Name	Seeding
ALB	ALB2221	M	PJETRI ERNIK	
ARM	ARM03008	M	KOSAKYAN SUREN	
AUT	AUT02950	M	KLEINEKATHOEFER JAKOB	
AZE	AZE02554	M	KARIMZADA NIHAD	
BIH	BIH2455	M	PALJEVAC SINAN	3
BUL	BUL003389	M	TASIM TUNCAY	
CRO	CRO2421	M	MILETA TOMA	4
CYP	CYP2327	M	CONSTANTINOU PANAGIOTIS	
ENG	ENG02926	M	PATRICK ASHTON	1
ESP	ESP02555	M	JIMENEZ DIAZ ALEJANDRO	
EST	EST02462	M	BOLOTSKIIH SAVELI	
FRA	FRA004502	M	KANGA KERTISS	
GER	GER02948	M	JENDREIZIK OLE	
GRE	GRE02300	M	PSOMAS ILIAS	
HUN	HUN003516	M	LISAL DAVID	
ISL	ISL2109	M	HALLDORSSON HUGI	
ISR	ISR003245	M	KASABRY NASRY	
ITA	ITA02898	M	PEZZOTTI GABRIELE	2
LAT	LAT02550	M	PUKE ROBERTS	
MKD	MKD2296	M	BOZHVIKJ DANILO	
MNE	MNE02924	M	DURUTOVIC DJORDJE	
NED	NED02509	M	VAN DER WEIDE NIEK	
POL	POL3106	M	WOZNIAK KAJETAN	
POR	POR003564	M	MATOS JOAO	
ROU	ROU2291	M	IONASCU EDUARD	
SCO	SCO02405	M	FURNESS CAMERON	
SRB	SRB2541	M	MILOSEVIC ILIJA	
SUI	SUI02697	M	PEDRO THEO	
SVK	SVK02638	M	BOHUNICKY LUKAS	
SWE	SWE02427	M	HAAG OZZY	
UKR	UKR02970	M	PIANTKIVSKYI DENYS	
WAL	WAL02264	M	LAWRENCE ALEXANDER	
WKF-1	AIN-1006669	M	MAGOMEDOV GADZHILAV	

U21 Kumite Male -84 kg

EKF Junior, Cadet & U21 Championships 2026 - Limassol, Spyros Kyprianou Athletic Center, Limassol, CYP

2026-02-07

Tatami
5 16:15

Pool
1/4

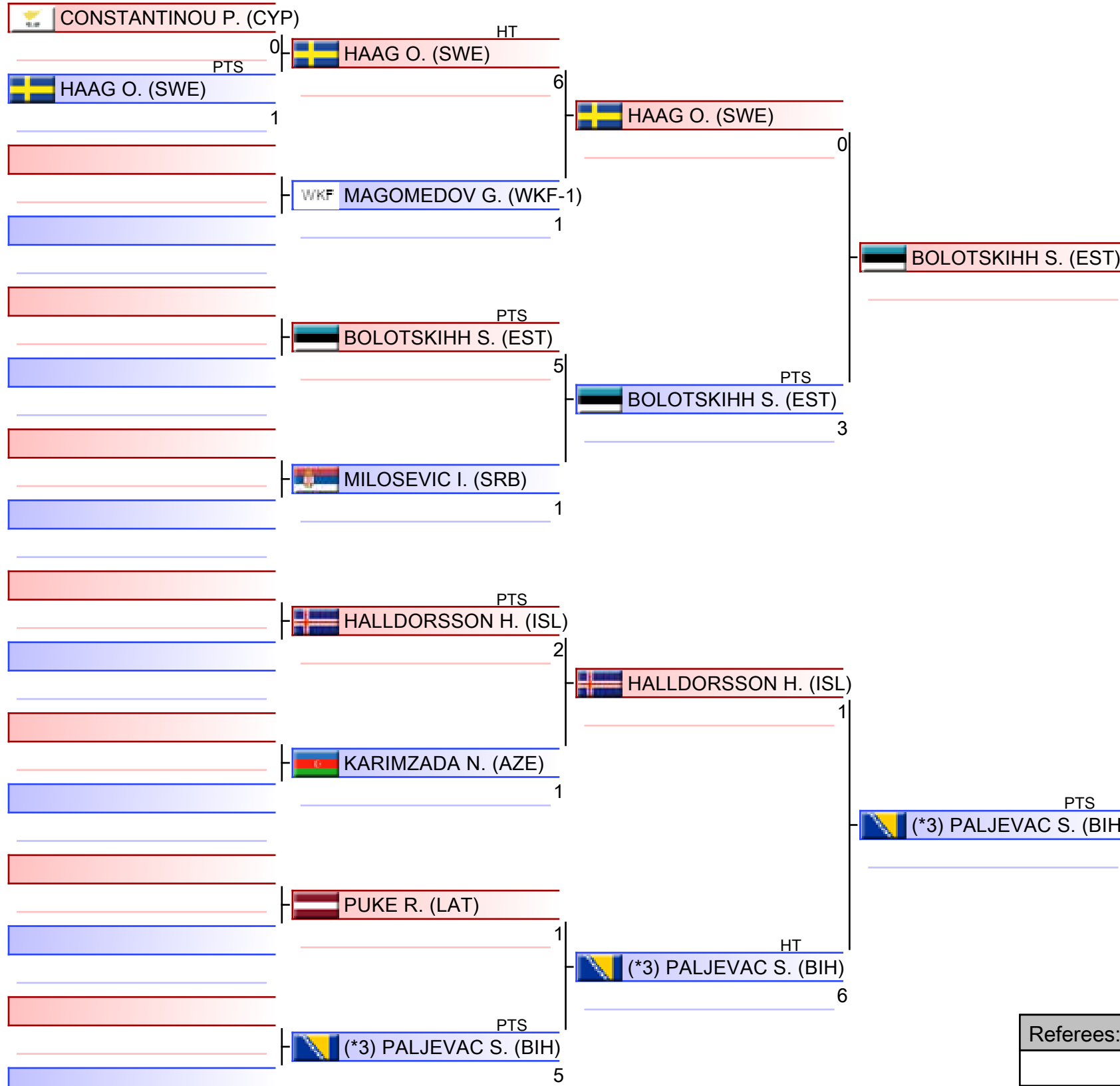

WKF
EUROPE

1. BOHUNICKY LUKAS (SVK)
2. PALJEVAC SINAN (BIH)
3. PSOMAS ILIAS (GRE)
3. HALLDORSSON HUGI (ISL)
5. PIANTKIVSKYI DENYS (UKR)
5. PEZZOTTI GABRIELE (ITA)
7. WOZNIAC KAJETAN (POL)
7. BOLOTSKIH S. (EST)

*Seeded

Referees:			

U21 Kumite Male -84 kg

EKF Junior, Cadet & U21 Championships 2026 - Limassol, Spyros Kyprianou Athletic Center, Limassol, CYP

2026-02-07

Tatami
5 17:05

Pool
2/4



WKF
EUROPE

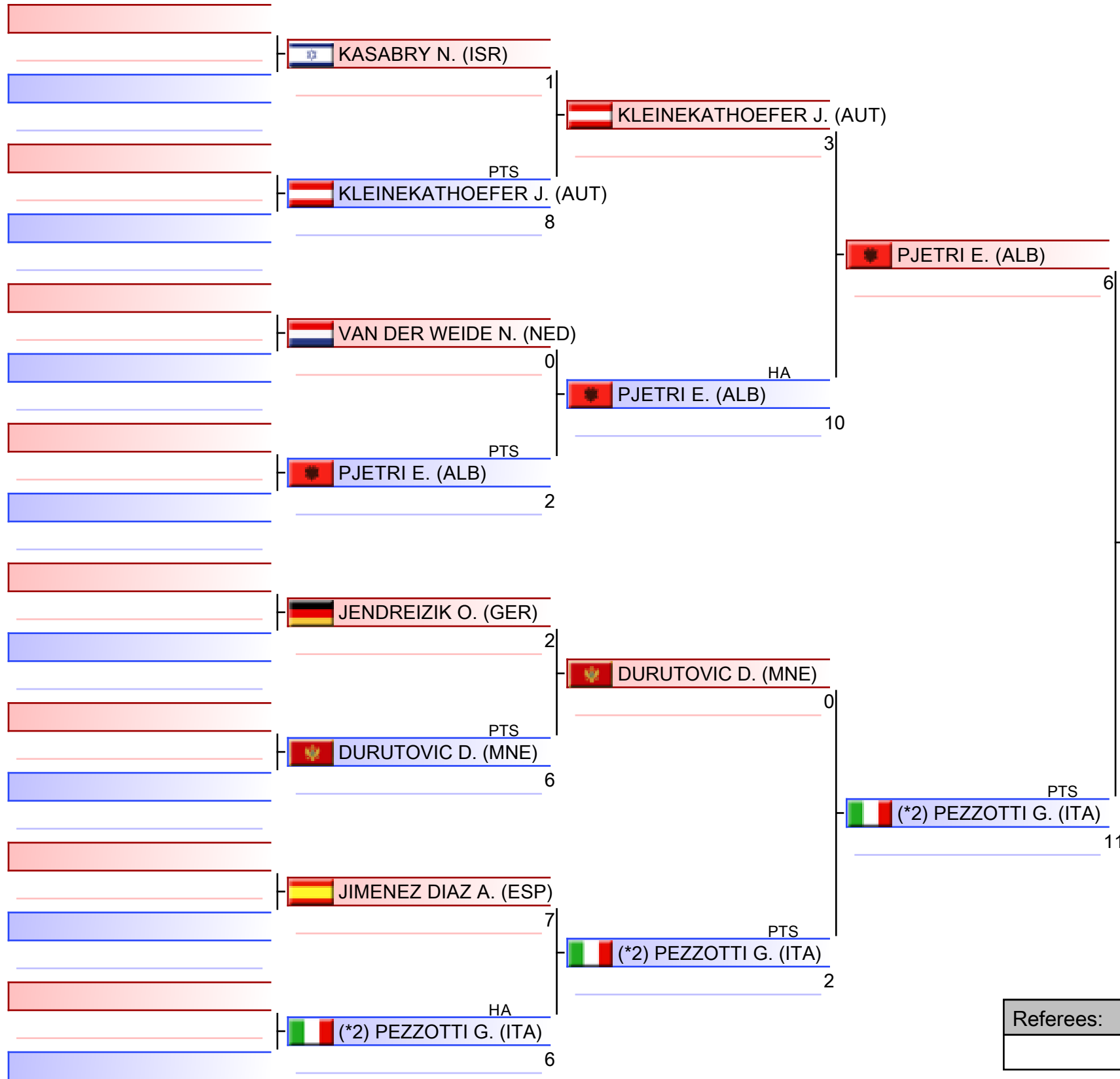

(*2) PEZZOTTI G. (ITA)

1. BOHUNICKY LUKAS (SVK)
2. PALJEVAC SINAN (BIH)
3. PSOMAS ILIAS (GRE)
3. HALLDORSSON HUGI (ISL)
5. PIANTKIVSKYI DENYS (UKR)
5. PEZZOTTI GABRIELE (ITA)
7. WOZNIAK KAJETAN (POL)
7. BOLOTSKIIH SAVELI (EST)

*Seeded

Referees:			

U21 Kumite Male -84 kg

EKF Junior, Cadet & U21 Championships 2026 - Limassol, Spyros Kyprianou Athletic Center, Limassol, CYP

2026-02-07

Tatami
6 16:05

Pool
3/4



WKF
EUROPE

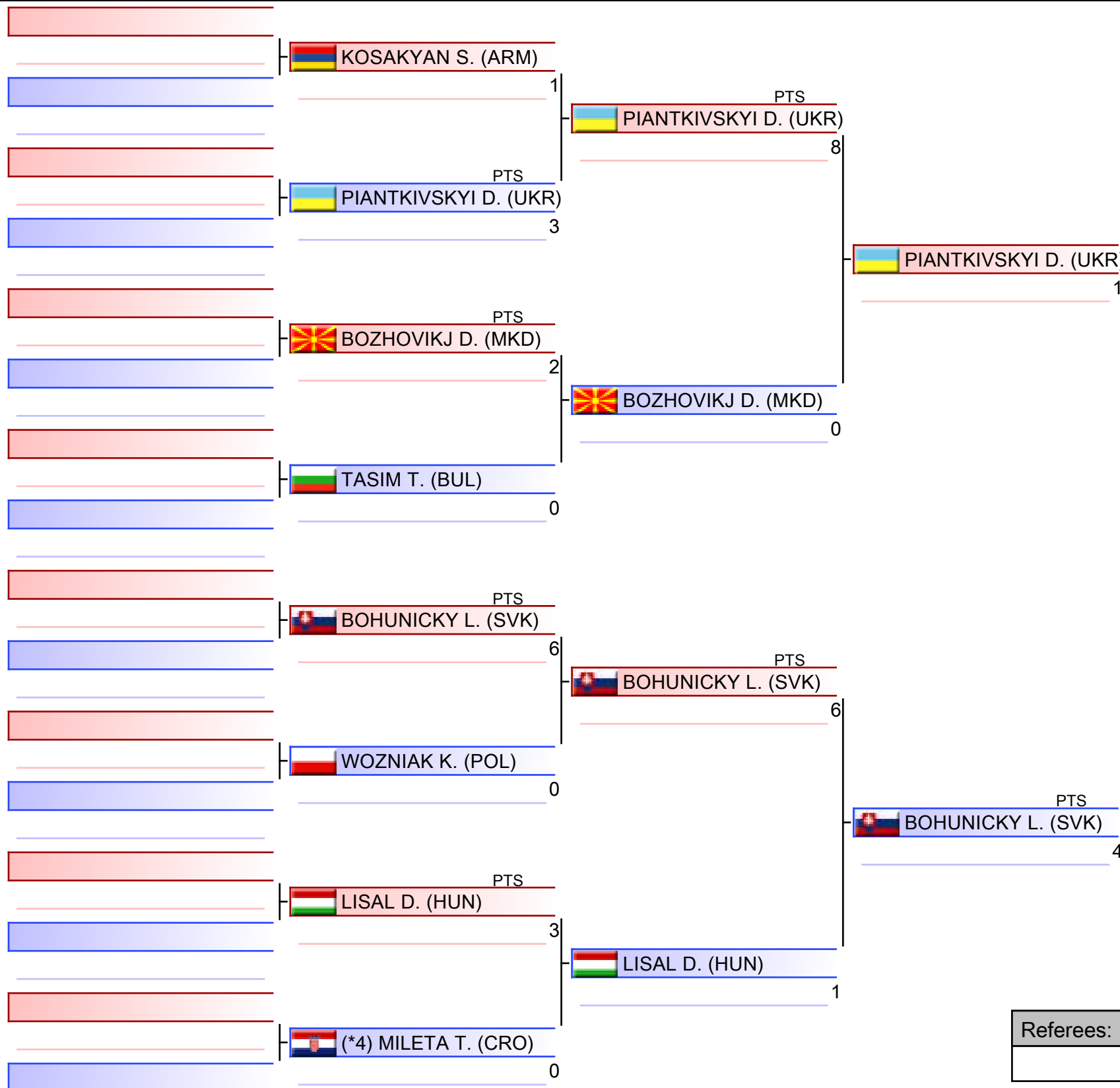

BOHUNICKY L. (SVK)

1. BOHUNICKY LUKAS (SVK)
2. PALJEVAC SINAN (BIH)
3. PSOMAS ILIAS (GRE)
3. HALLDORSSON HUGI (ISL)
5. PIANTKIVSKYI DENYS (UKR)
5. PEZZOTTI GABRIELE (ITA)
7. WOZNIAK KAJETAN (POL)
7. BOLOTSKIIH SAVELI (EST)

*Seeded

Referees:			

U21 Kumite Male -84 kg

EKF Junior, Cadet & U21 Championships 2026 - Limassol, Spyros Kyprianou Athletic Center, Limassol, CYP

2026-02-07

Tatami
6 16:50

Pool
4/4

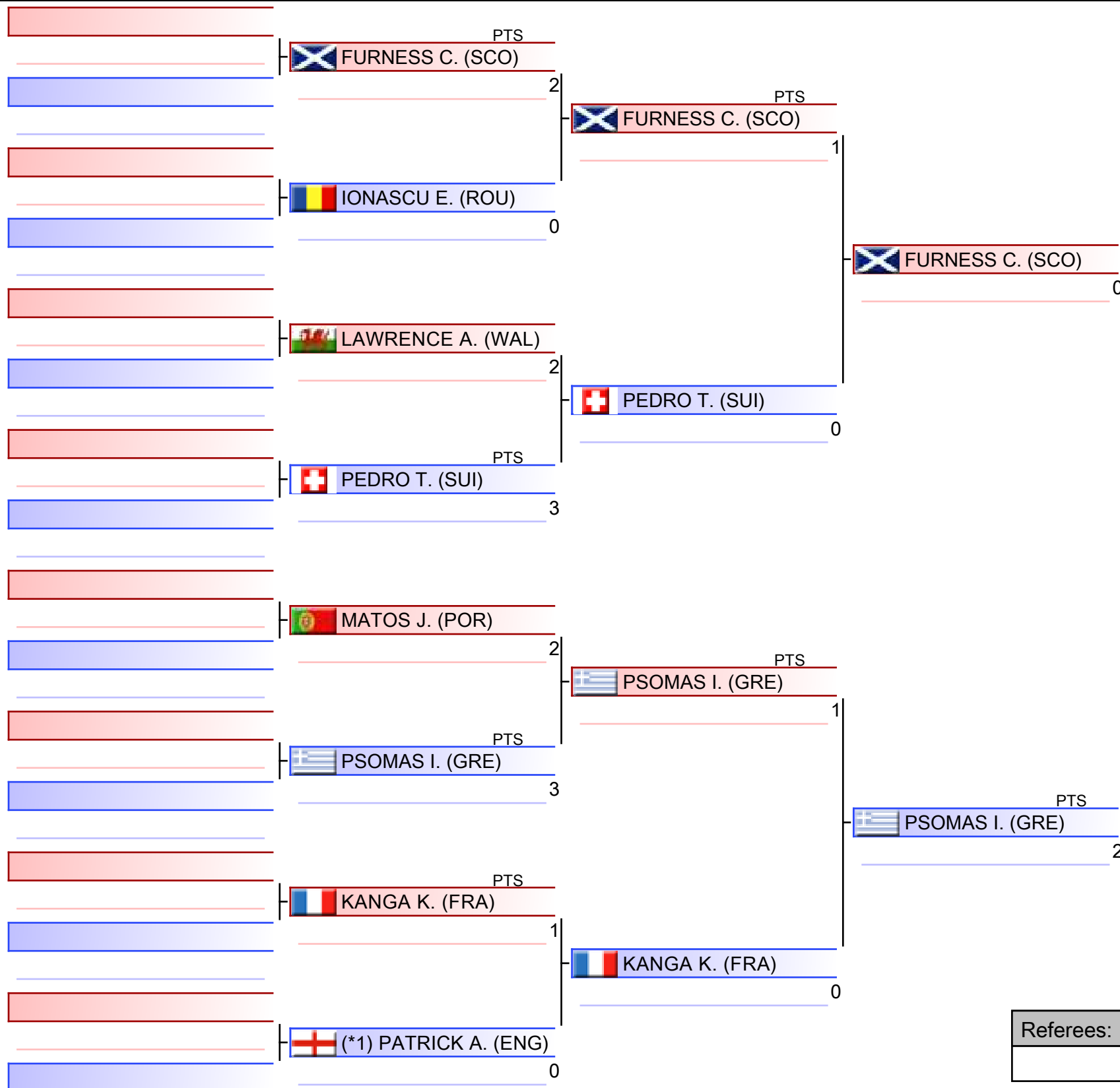

WKF
EUROPE

1. BOHUNICKY LUKAS (SVK)
2. PALJEVAC SINAN (BIH)
3. PSOMAS ILIAS (GRE)
3. HALLDORSSON HUGI (ISL)
5. PIANTKIVSKYI DENYS (UKR)
5. PEZZOTTI GABRIELE (ITA)
7. WOZNIAK KAJETAN (POL)
7. BOLOTSKIIH SAVELI (EST)

*Seeded

Referees:			

Pool winner-U21 Kumite Male -84 kg

EKF Junior, Cadet & U21 Championships 2026 - Limassol, Spyros Kyprianou Athletic Center, Limsassol, CYP

2026-02-07

Tatami
5 17:50

Pool
1/1

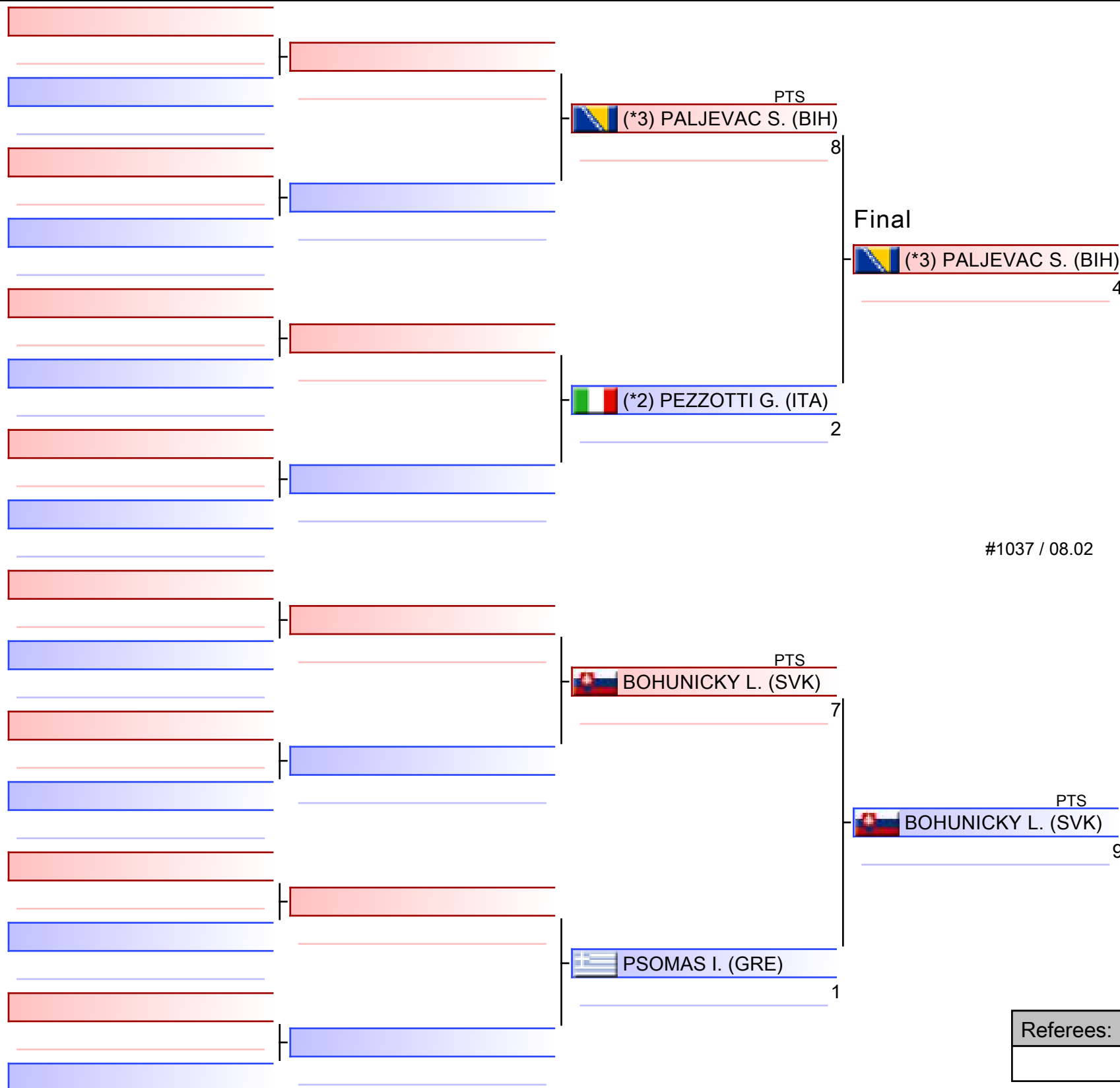

1. BOHUNICKY LUKAS (SVK)
2. PALJEVAC SINAN (BIH)
3. PSOMAS ILIAS (GRE)
3. HALLDORSSON HUGI (ISL)
5. PIANTKIVSKYI DENYS (UKR)
5. PEZZOTTI GABRIELE (ITA)
7. WOZNIAC KAJETAN (POL)
7. BOLOTSKIIH SAVELI (EST)

*Seeded

Referees:			

U21 Kumite Male -84 kg

EKF Junior, Cadet & U21 Championships 2026 - Limassol

2026-02-07

Tatami
6 18:30

Pool
1,2

(c)sportdata GmbH & Co KG 2000-2026 (2026-02-08 17:46) v 11.0.0 build 2 (2025-01-21 11:49 CET) License: SDIL TWG2025 (expire 2026-09-30)

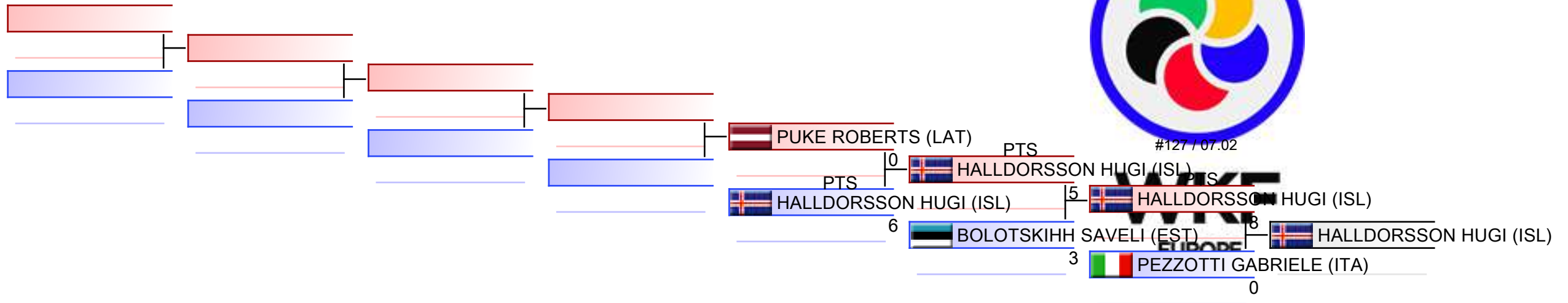

REPECHAGE: (1,2)

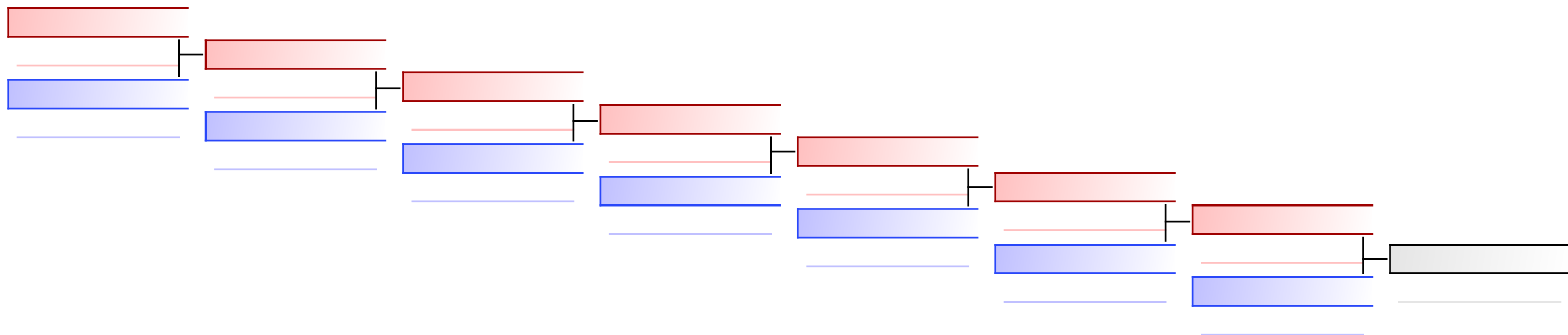

Referees:							
-----------	--	--	--	--	--	--	--

U21 Kumite Male -84 kg

EKF Junior, Cadet & U21 Championships 2026 - Limassol

2026-02-07

Tatami
6 18:50

Pool
3,4

(c)sportdata GmbH & Co KG 2000-2026 (2026-02-08 17:46) v 11.0.0 build 2 (2025-01-21 11:49 CET) License: SDIL TWG2025 (expire 2026-09-30)

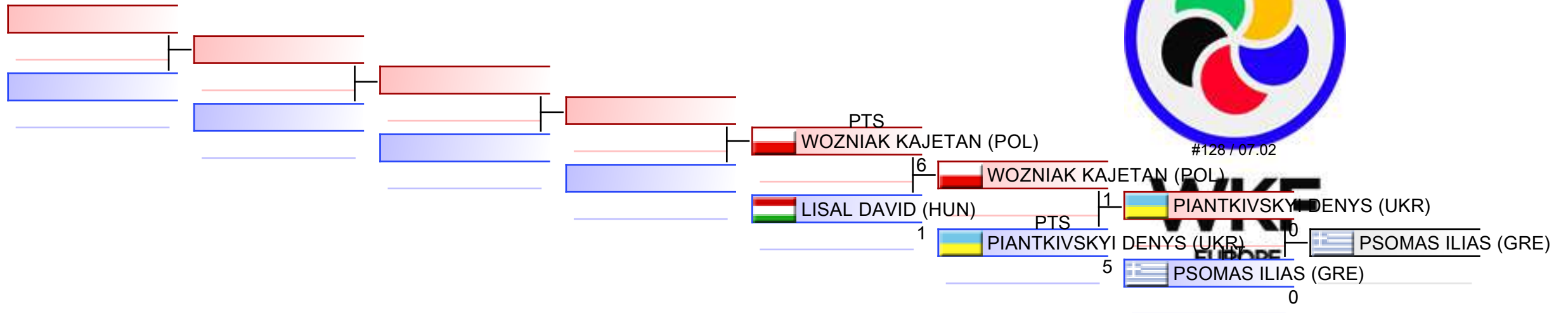

REPECHAGE: (3,4)

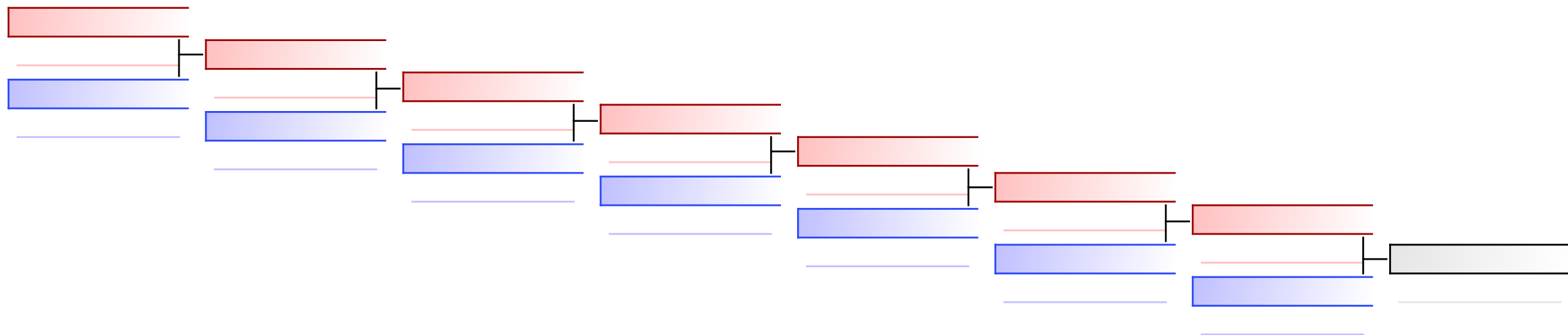

Referees:							
-----------	--	--	--	--	--	--	--



EKF Junior, Cadet & U21 Championships
2026 - Limassol - 2026-02-06



Official Results

U21 Kumite Male -84 kg			
1	BOHUNICKY LUKAS		SVK - SLOVAKIA
2	PALJEVAC SINAN		BIH - BOSNIA AND HERZEGOVINA
3	PSOMAS ILIAS		GRE - GREECE
3	HALLDORSSON HUGI		ISL - ICELAND
5	PIANTKIVSKYI DENYS		UKR - UKRAINE
5	PEZZOTTI GABRIELE		ITA - ITALY
7	WOZNIAK KAJETAN		POL - POLAND
7	BOLOTSKIIH SAVELI		EST - ESTONIA
9	LISAL DAVID		HUN - HUNGARY
9	PUKE ROBERTS		LAT - LATVIA

U21 KUMITE MALE 84+ KG



EKF Junior, Cadet & U21 Championships 2026 - Lim..



ENTRIES BY WEIGHT CATEGORY

U21 Kumite Male 84+ kg

As of 8 FEB 2026

Code	ID	Gender	Name	Seeding
ALB	ALB02536	M	HOXHAI VILSJAN	
AUT	AUT02528	M	SELIMOVIC ARMIN	
AZE	AZE02464	M	HASANOV VAHID	
BEL	BEL02580	M	JADOUL ERWAN	3
BIH	BIH2620	M	SMAJIC HARUN	
CRO	CRO03130	M	PLESIVCAK MISLAV	1
CYP	CYP2207	M	SOBAKIN ALEXANDROS	
DEN	DEN02638	M	HOULBERG MEJLHEDE LUCAS	
ESP	ESP02882	M	HURTADO CANIZO SAMUEL	
FIN	FIN02182	M	MANTERE JIMI	
FRA	FRA03554	M	TADJER ADAM	
GEO	GEO02556	M	GIGAURI NIKOLOZ	
GER	GER004229	M	SEJFIC SEFO	
GRE	GRE02448	M	MOKAS MICHAIL	
ITA	ITA04409	M	BURROSI SAMUELE	
LTU	LTU002632	M	ZAUKAS KAROLIS	
LUX	LUX02279	M	DAVIES ALEXANDER	
MKD	MKD2587	M	STOJANOV FILIP	
MNE	MNE2186	M	POTPARA LAZAR	2
POL	POL2991	M	KIRYLUK PAWEL	4
POR	POR02807	M	CASSAMA JOSE	
ROU	ROU03089	M	VASILE DAVID GABRIEL	
SCO	SCO02197	M	ANDERSON SCOTT	
SRB	SRB2494	M	PEJOVIC UGLJESA	
SUI	SUI02692	M	BANDELIER MATHIS	
SVK	SVK02722	M	KRALIK TOMAS	
UKR	UKR02868	M	KOZYLIAN OLEKSANDR	
WKF-2	AIN-2002778	M	KUDZINAU IVAN	

U21 Kumite Male 84+ kg

EKF Junior, Cadet & U21 Championships 2026 - Limassol, Spyros Kyprianou Athletic Center, Limassol, CYP

2026-02-07

Tatami
7 16:05

Pool
1/4



WKF
EUROPE

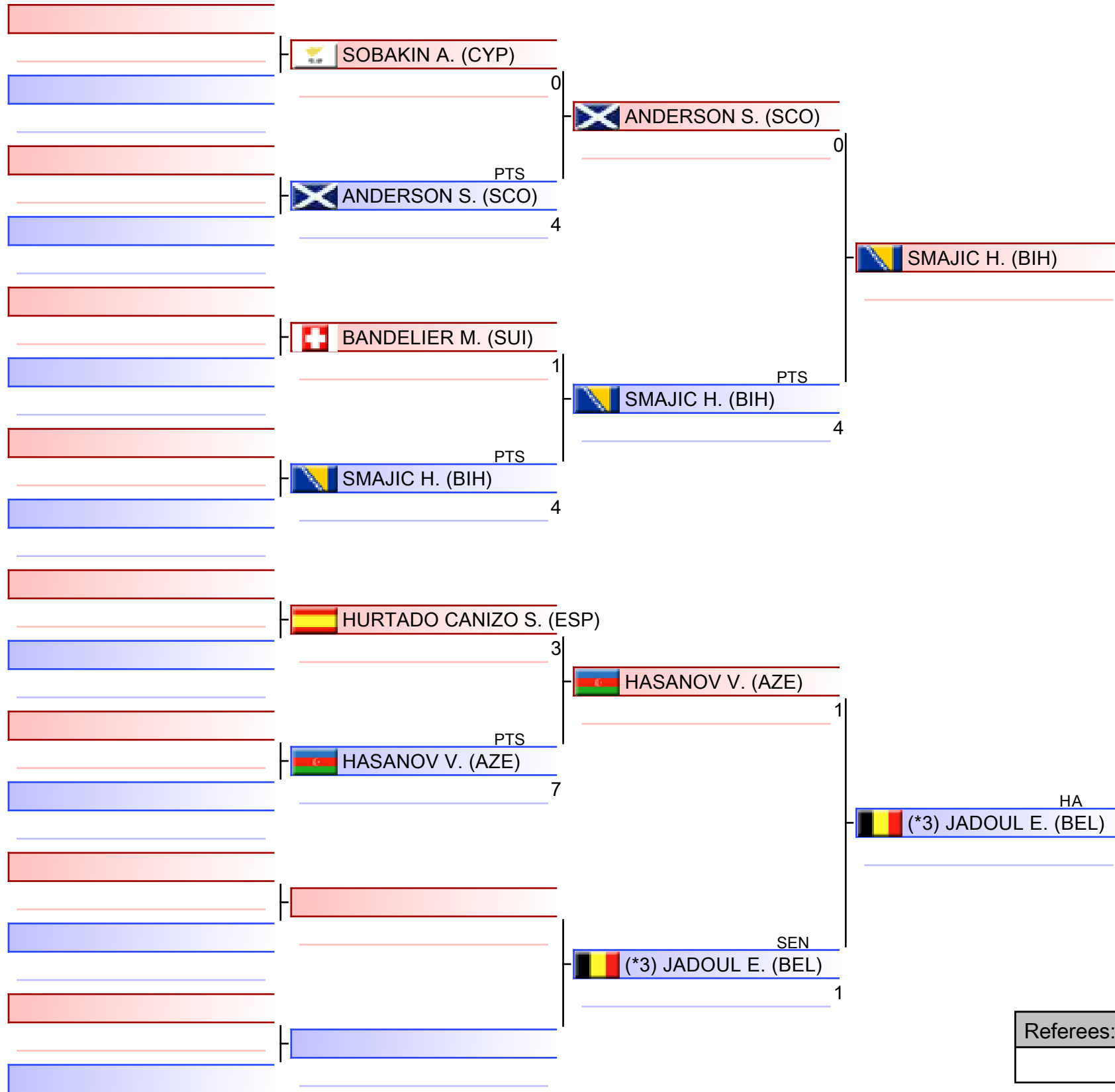

(*)3 JADOUL E. (BEL)

1. DAVIES ALEXANDER (LUX)
2. KOZYLIAN OLEKSANDR (UKR)
3. JADOUL ERWAN (BEL)
3. CASSAMA JOSE (POR)
5. TADJER ADAM (FRA)
5. BURROSI SAMUELE (ITA)
7. POTPARA LAZAR (MNE)
7. KIRYLUK PAWEL (POL)

*Seeded

Referees:			

U21 Kumite Male 84+ kg

EKF Junior, Cadet & U21 Championships 2026 - Limassol, Spyros Kyprianou Athletic Center, Limassol, CYP

2026-02-07

Tatami
7 16:40

Pool
2/4



WKF
EUROPE

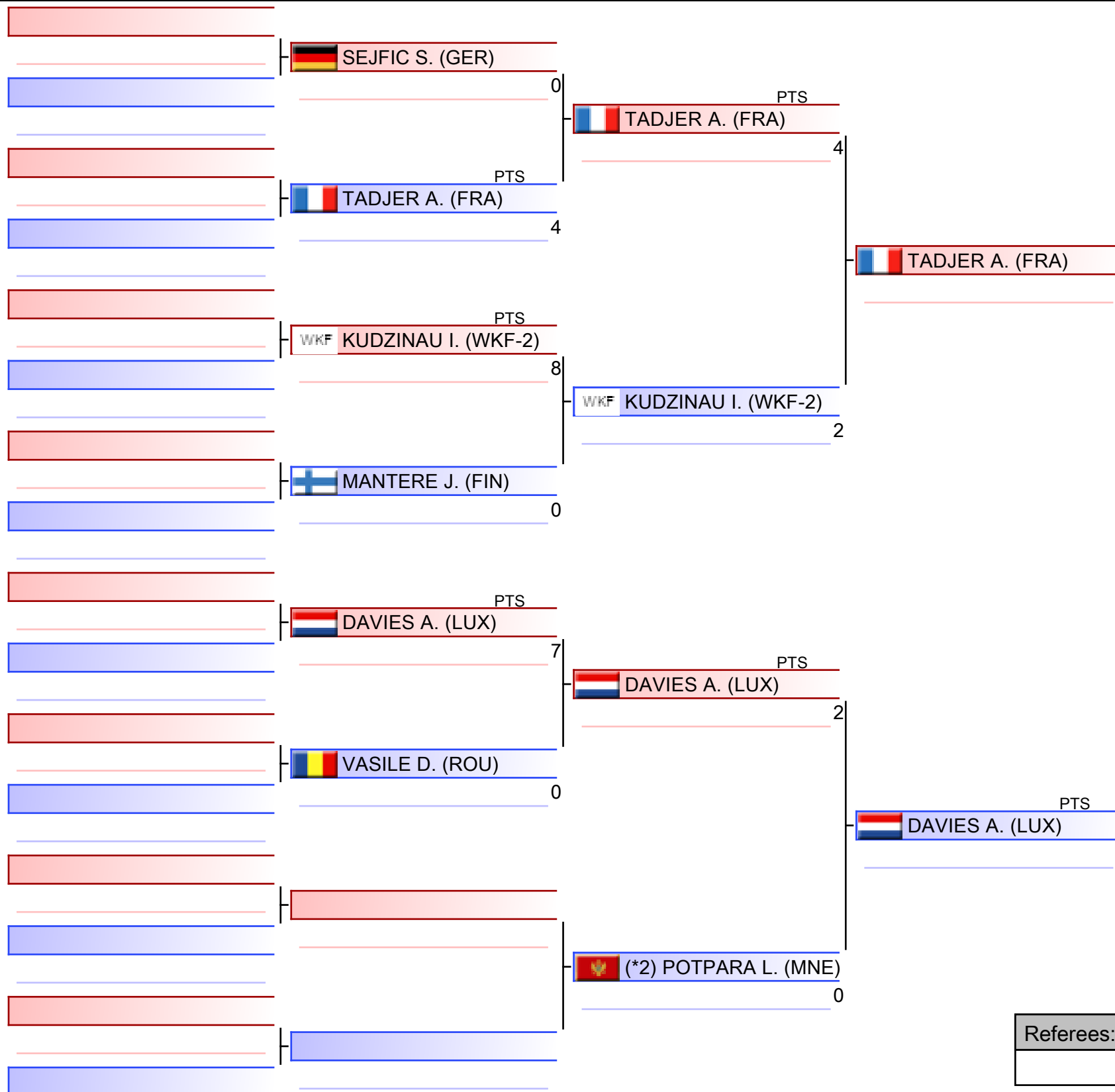

1. DAVIES ALEXANDER (LUX)
2. KOZYLIAN OLEKSANDR (UKR)
3. JADOUL ERWAN (BEL)
3. CASSAMA JOSE (POR)
5. TADJER ADAM (FRA)
5. BURROSI SAMUELE (ITA)
7. POTPARA LAZAR (MNE)
7. KIRYLUK PAWEL (POL)

*Seeded

Referees:			

U21 Kumite Male 84+ kg

EKF Junior, Cadet & U21 Championships 2026 - Limassol, Spyros Kyprianou Athletic Center, Limassol, CYP

2026-02-07

Tatami
8 15:40

Pool
3/4



WKF
EUROPE

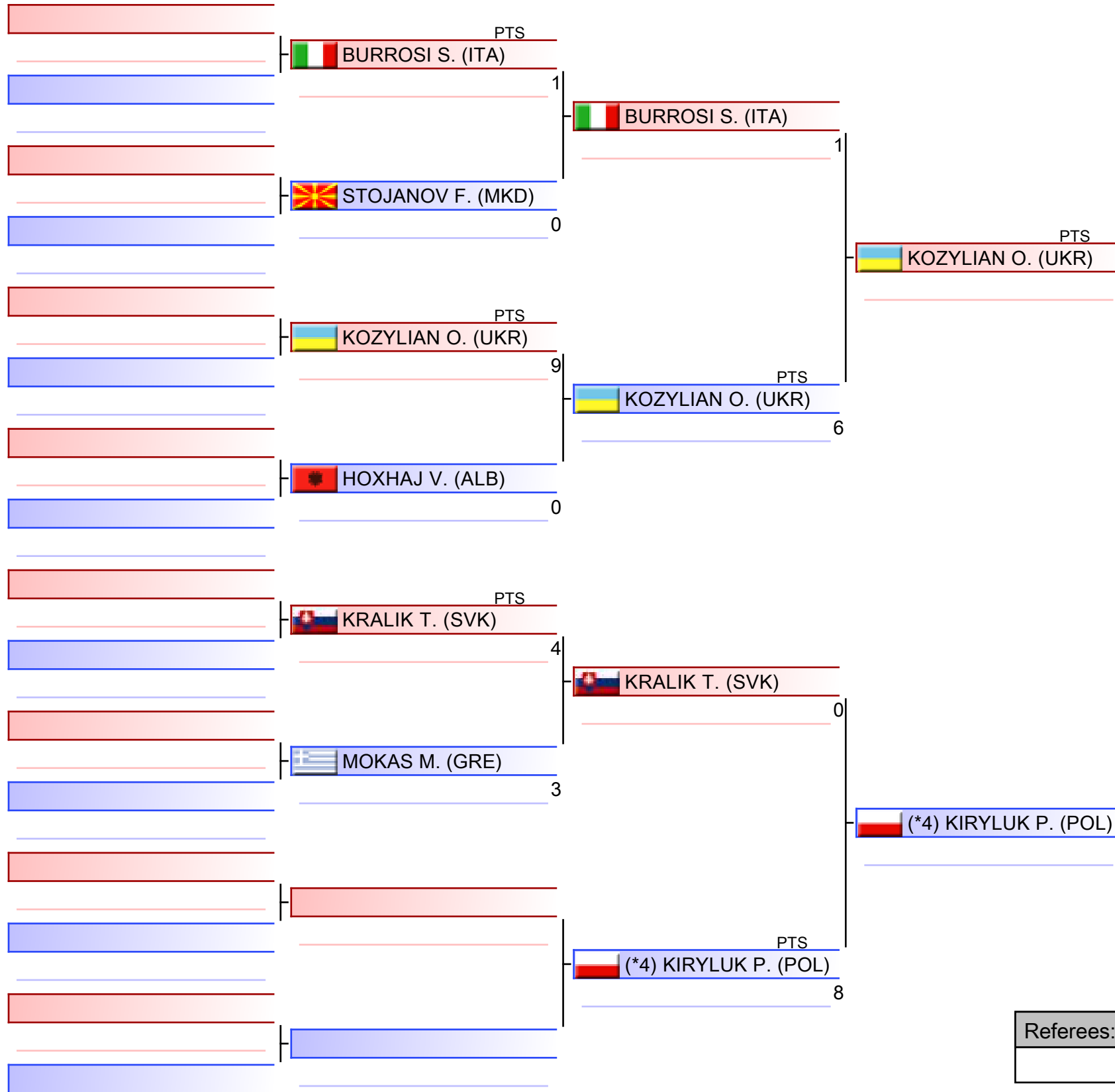

KOZYLIAN O. (UKR)

1. DAVIES ALEXANDER (LUX)
2. KOZYLIAN OLEKSANDR (UKR)
3. JADOUL ERWAN (BEL)
3. CASSAMA JOSE (POR)
5. TADJER ADAM (FRA)
5. BURROSI SAMUELE (ITA)
7. POTPARA LAZAR (MNE)
7. KIRYLUK PAWEL (POL)

*Seeded

Referees:			

U21 Kumite Male 84+ kg

EKF Junior, Cadet & U21 Championships 2026 - Limassol, Spyros Kyprianou Athletic Center, Limassol, CYP

2026-02-07

Tatami
8 16:15

Pool
4/4

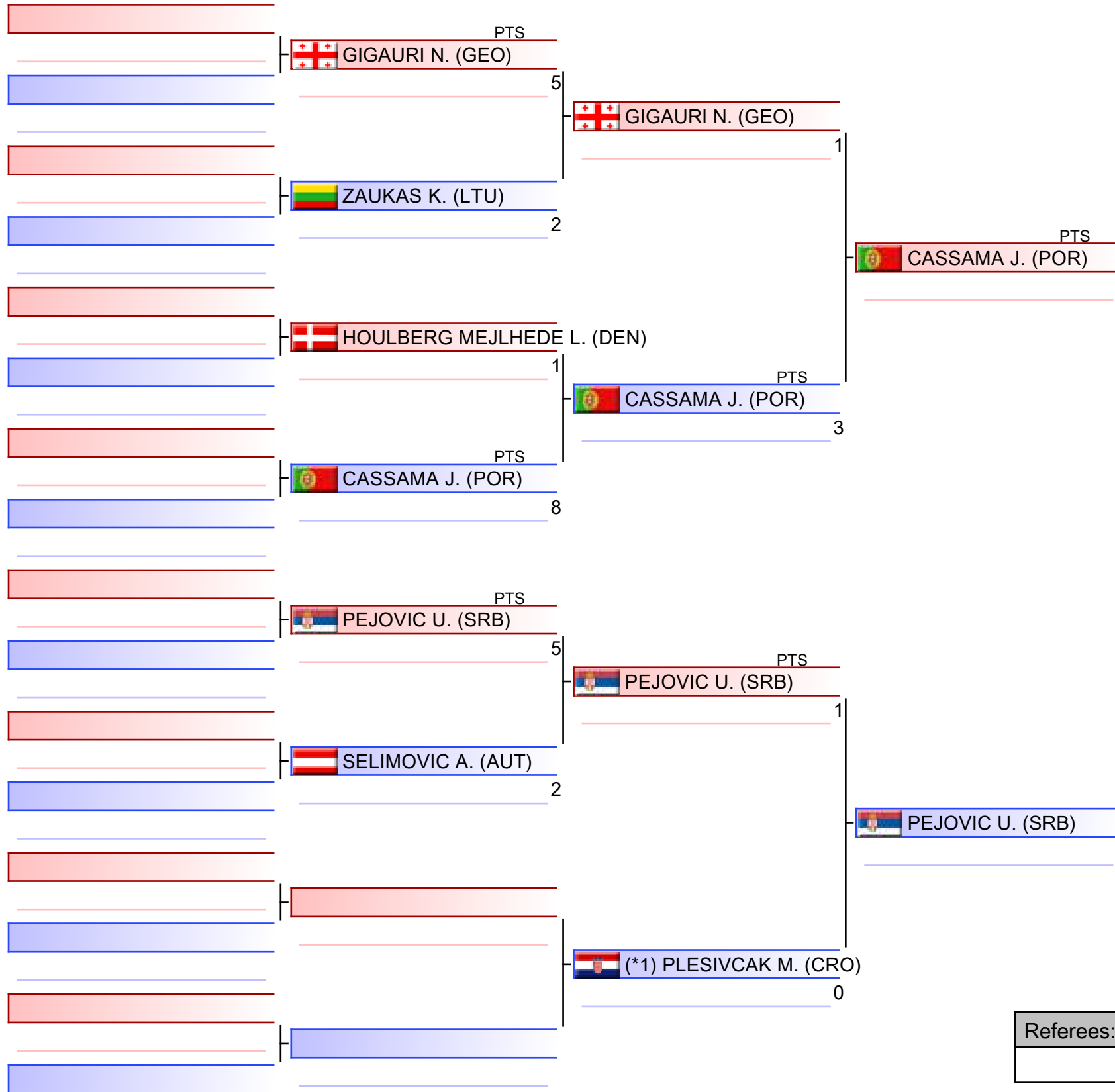

WKF
EUROPE

1. DAVIES ALEXANDER (LUX)
2. KOZYLIAN OLEKSANDR (UKR)
3. JADOUL ERWAN (BEL)
3. CASSAMA JOSE (POR)
5. TADJER ADAM (FRA)
5. BURROSI SAMUELE (ITA)
7. POTPARA LAZAR (MNE)
7. KIRYLUK PAWEL (POL)

*Seeded

Referees:			

Pool winner-U21 Kumite Male 84+ kg

EKF Junior, Cadet & U21 Championships 2026 - Limassol, Spyros Kyprianou Athletic Center, Limassol, CYP

2026-02-07

Tatami
7 17:15

Pool
1/1

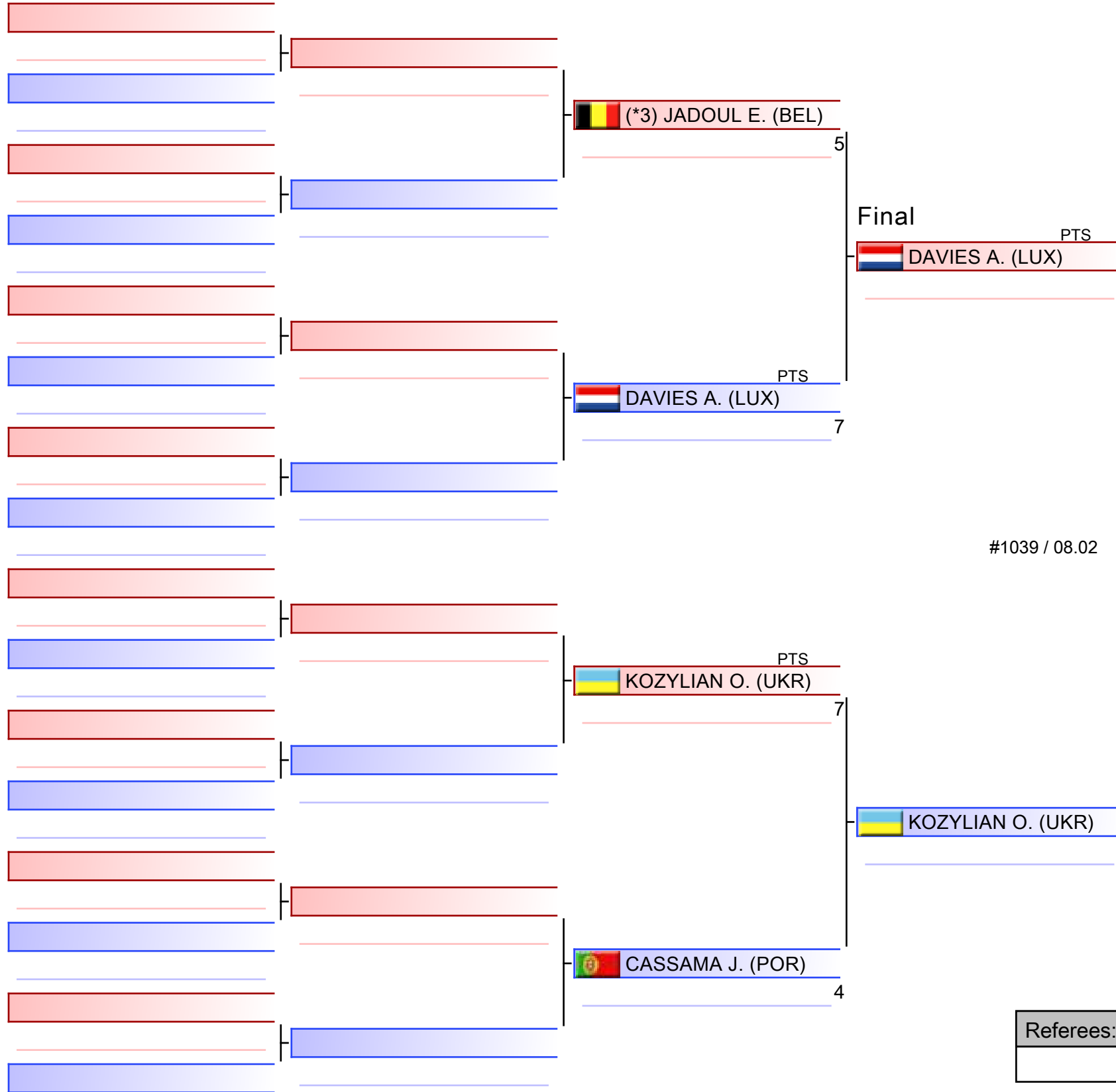

WKF
EUROPE

1. DAVIES ALEXANDER (LUX)
2. KOZYLIAN OLEKSANDR (UKR)
3. JADOUL ERWAN (BEL)
3. CASSAMA JOSE (POR)
5. TADJER ADAM (FRA)
5. BURROSI SAMUELE (ITA)
7. POTPARA LAZAR (MNE)
7. KIRYLUK PAWEL (POL)

*Seeded

Referees:			

U21 Kumite Male 84+ kg

EKF Junior, Cadet & U21 Championships 2026 - Limassol

2026-02-07

Tatami
8 18:15

Pool
1,2,3,4

(c)sportdata GmbH & Co KG 2000-2026 (2026-02-08 17:46) v 11.0.0 build 2 (2025-01-21 11:49 CET) License: SDIL TWG2025 (expire 2026-09-30)

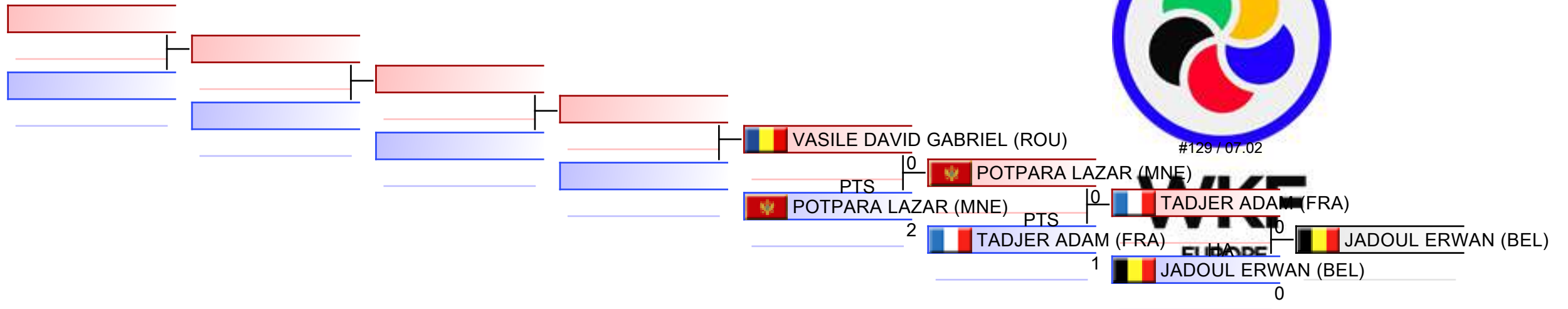

REPECHAGE: (1,2,3,4)

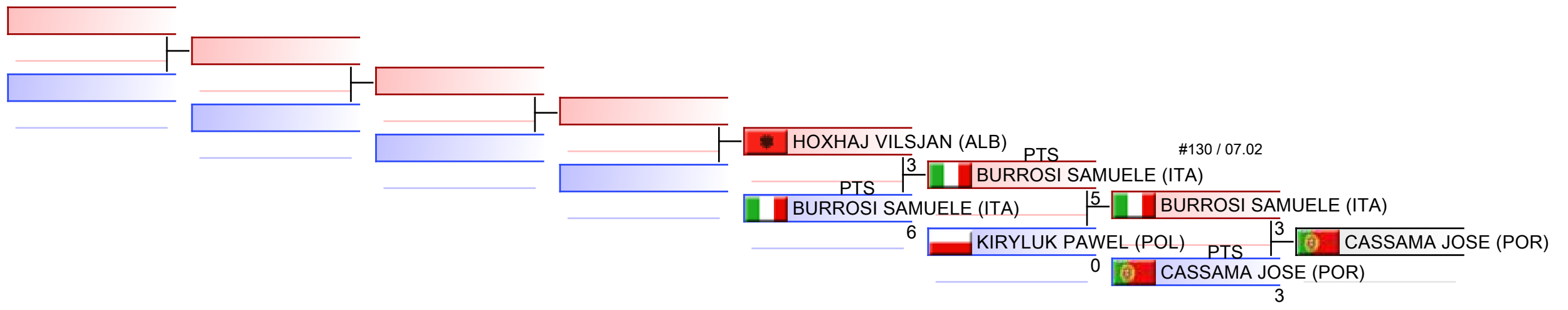

Referees:							
-----------	--	--	--	--	--	--	--



EKF Junior, Cadet & U21 Championships
2026 - Limassol - 2026-02-06



Official Results

U21 Kumite Male 84+ kg			
1	DAVIES ALEXANDER		LUX - LUXEMBOURG
2	KOZYLIAN OLEKSANDR		UKR - UKRAINE
3	JADOUL ERWAN		BEL - BELGIUM
3	CASSAMA JOSE		POR - PORTUGAL
5	TADJER ADAM		FRA - FRANCE
5	BURROSI SAMUELE		ITA - ITALY
7	POTPARA LAZAR		MNE - MONTENEGRO
7	KIRYLUK PAWEL		POL - POLAND
9	VASILE DAVID GABRIEL		ROU - ROMANIA
9	HOXHAJ VILSJAN		ALB - ALBANIA

OFFICIAL RESULTS



EKF Junior, Cadet & U21 Championships
2026 - Limassol - 2026-02-06



Official Results

Cadet Kata Female			
1	PENA GARCIA CANDELA		ESP - SPAIN
2	BELJKAS NEDA		MNE - MONTENEGRO
3	GOETHE MARIEL		GER - GERMANY
3	BRANDAUER CHIARA		POR - PORTUGAL
5	BENKO SZONJA LOLA		HUN - HUNGARY
5	AWAD ATTIA JENNA		MLT - MALTA
7	KISSKOVA KAROLINA		SVK - SLOVAKIA
7	CAYLA ANAIS		FRA - FRANCE
9	NICOLAOU KALLIOPI		CYP - CYPRUS
9	SHCHERBININA ANASTASIIA		UKR - UKRAINE

Cadet Kata Male			
1	RAZVAN GEORGE FLOREA		ROU - ROMANIA
2	VALENTE SALVADOR		POR - PORTUGAL
3	GONZALEZ SAEZ HUGO		ESP - SPAIN
3	FAIC DAVID		CRO - CROATIA
5	MACKO PETER		SVK - SLOVAKIA
5	PILLANT METIS		FRA - FRANCE
7	LOEBEL YALI IDAN		ISR - ISRAEL
7	ILCIK ADAM		CZE - CZECH REPUBLIC
9	OVNIC TIAN		SLO - SLOVENIA

Cadet Kumite Female -47 kg			
1	KAKUTIA SALOME		GEO - GEORGIA
2	MAISTRENKO HANNA		UKR - UKRAINE
3	BALANESCU MARIA		ROU - ROMANIA
3	KLEANTHOUS ARETI		CYP - CYPRUS
5	ARNAUTOVIC ZAHRA		BIH - BOSNIA AND HERZEGOVINA
5	SKITARELIC GABI		CRO - CROATIA
7	ZAJANCKAUSKYTE KOTRYNA		LTU - LITHUANIA
7	PODVOREC NIVES		GER - GERMANY
9	KIMYAGAROV LIEL		ISR - ISRAEL
9	JEJINIC LEA		AUT - AUSTRIA

Cadet Kumite Female -54 kg			
1	ELII SOFIIA		UKR - UKRAINE
2	KALOEVA KIRA		WKF-1 - WKF-1
3	BALANESCU IOANA		ROU - ROMANIA
3	CHICA TOLOSA ARIADNA		ESP - SPAIN
5	MARKOVIC PETRA		MNE - MONTENEGRO
5	POSKIN EMILIE		BEL - BELGIUM
7	RADAUTA LOREDANA		MDA - MOLDOVA, REPUBLIC OF
7	KUN REGINA KIRA		HUN - HUNGARY
9	SVOBODOVA ELISKA		CZE - CZECH REPUBLIC
9	POULSEN JO KJAER		DEN - DENMARK



EKF Junior, Cadet & U21 Championships
2026 - Limassol - 2026-02-06



Official Results

11	DELORME AMINA		FRA - FRANCE	
----	---------------	--	--------------	--

Cadet Kumite Female -61 kg

1	VOLIK ANNA		WKF-1 - WKF-1	
2	POPOVA DIANA		UKR - UKRAINE	
3	MEYEN SELDA		GER - GERMANY	
3	DUFF JULIA		SCO - SCOTLAND	
5	GASPAROVA JESSICA		SVK - SLOVAKIA	
5	POPESCU BIANCA		ROU - ROMANIA	
7	GEORGIEVA STEFANI		BUL - BULGARIA	
7	STAVECKAITE BARBORA		LTU - LITHUANIA	
9	BISGAARD IDA		DEN - DENMARK	
9	STEFANSKI VANESSA		FIN - FINLAND	

Cadet Kumite Female 61+ kg

1	SANTOS MADALENA		POR - PORTUGAL	
2	REXHEPI LANIKA		ALB - ALBANIA	
3	ESSABAR MERYEM		FRA - FRANCE	
3	DANILOVA SOFIA		WKF-1 - WKF-1	
5	ONORI SOFIA		ITA - ITALY	
5	MARIA CARINA POPESCU		ROU - ROMANIA	
7	AMBARYAN LIKA		GEO - GEORGIA	
7	NUNEZ ABREU NAGORE		ESP - SPAIN	
9	DJOROJEVIC GORANA		MNE - MONTENEGRO	

Cadet Kumite Male -52 kg

1	DOROSH MARK		UKR - UKRAINE	
2	CAFISO EDOARDO		ITA - ITALY	
3	DADESKELIANI LEVANI		GEO - GEORGIA	
3	HASANI NEEVIS		ALB - ALBANIA	
5	MORAITIS IOANNIS-ADAMANTIOS		GRE - GREECE	
5	LOPEZ PEREZ HUGO		ESP - SPAIN	
7	ALJOSEVIC ARIJAN		MNE - MONTENEGRO	
7	MEMEDI MERVAN		MKD - NORTH MACEDONIA	
9	GREBNOVS ILJA		LAT - LATVIA	
9	FICHTELMANN ERIC		GER - GERMANY	
11	MARCINEK MAXIM		SVK - SLOVAKIA	

Cadet Kumite Male -57 kg

1	TANEV IOAN		BUL - BULGARIA	
2	GIULIANI ACHILLE		ITA - ITALY	
3	ARRIBAS JIMENEZ OSCAR		ESP - SPAIN	
3	PUMPURS ANDREJS		LAT - LATVIA	
5	SHEVCHENKO STANISLAV		UKR - UKRAINE	
5	STAVRIDIS DIMITRIOS		GRE - GREECE	
7	SPANIK TOBIAS		CZE - CZECH REPUBLIC	
7	BOHOUDI ILYAS		NED - NETHERLANDS	



EKF Junior, Cadet & U21 Championships
2026 - Limassol - 2026-02-06



Official Results

9	SOKOLOV KIRILL		WKF-1 - WKF-1	
9	CORDASEV TOMISLAV		CRO - CROATIA	

Cadet Kumite Male -63 kg				
1	BALDASSARRE RAFFAELE		ITA - ITALY	
2	ALMEKHAMETOV EMIL		WKF-1 - WKF-1	
3	BUDNY SZYMON		POL - POLAND	
3	KOVAL DAVID		SVK - SLOVAKIA	
5	KOMARAC FILIP		CRO - CROATIA	
5	DZORLEV MARKO		MKD - NORTH MACEDONIA	
7	GARCIA DE BLAS REDONDO RODRIGO		ESP - SPAIN	
7	MARTIN MAXIMILIAN		GER - GERMANY	
9	ANDERSSON EMIL		SWE - SWEDEN	

Cadet Kumite Male -70 kg				
1	BRODIE CULLEN		SCO - SCOTLAND	
2	DE GREGORIO RICCARDO		ITA - ITALY	
3	GRISHKIN EGOR		WKF-1 - WKF-1	
3	PSOMAS IOANNIS		GRE - GREECE	
5	BERMANEC DAVID		CRO - CROATIA	
5	BAUMGARTNER CEBRAIL		SUI - SWITZERLAND	
7	RAKOCEVIC LAZAR		MNE - MONTENEGRO	
7	TAKALA ANTON		FIN - FINLAND	
9	BLANCO CASTRO MARCOS		ESP - SPAIN	
9	DEMURIA DIEGO		GEO - GEORGIA	

Cadet Kumite Male 70+ kg				
1	GOGRICHIANI OMAR		GEO - GEORGIA	
2	MLADENOVIC NEMANJA		MKD - NORTH MACEDONIA	
3	MITRIK RICHARD		SVK - SLOVAKIA	
3	IGARELU VICTOR		ROU - ROMANIA	
5	LAZARIDIS PANAGIOTIS		GRE - GREECE	
5	ZUNDJA EMIR		BIH - BOSNIA AND HERZEGOVINA	
7	VITASEK LUKAS		CZE - CZECH REPUBLIC	
7	KAMILOV SHAMO		AZE - AZERBAIJAN	
9	GORA MARCEL		IRL - IRELAND	
9	DEL SEPPIA GIACOMO		ITA - ITALY	

Junior Kata Female				
1	MARQUES RITA		POR - PORTUGAL	
2	MANCA GIULIA		BEL - BELGIUM	
3	CASTRO LOPEZ ROCIO		ESP - SPAIN	
3	JURCEVIC LARA		CRO - CROATIA	
5	LIBIK TAMARA		GER - GERMANY	
5	ZERVOU ELENI		GRE - GREECE	
7	VAPPER MINOU		SWE - SWEDEN	
7	SALIBA FRANCESCA		MLT - MALTA	



EKF Junior, Cadet & U21 Championships
2026 - Limassol - 2026-02-06



Official Results

Junior Kata Male			
1	MATEUS VASCO		POR - PORTUGAL
2	LEON DE LA PENA JOSE ANGEL		ESP - SPAIN
3	KLEMZ THOMAS		FRA - FRANCE
3	SALMANOV SALMAN		AZE - AZERBAIJAN
5	BRZOBOHATY MICHAL		CZE - CZECH REPUBLIC
5	MARCHESE LUCIO		ITA - ITALY
7	PETERSEN LUKAS MURAKAMI		DEN - DENMARK
7	MAJOR EMMANUEL		WAL - WALES
9	SCHEDDEL NOLAN		SUI - SWITZERLAND
9	GASICKAS ROKAS		LTU - LITHUANIA

Junior Kumite Female -48 kg			
1	KOMINI ILIANA		GRE - GREECE
2	KOTENKO VIERONIKA		UKR - UKRAINE
3	KONAJEVA JEVGENIJA		LAT - LATVIA
3	MIERNA ADRIANA		SVK - SLOVAKIA
5	LEONOVA VARVARA		WKF-1 - WKF-1
5	MATOS ISIS		POR - PORTUGAL
7	BESLIJA ELENA		CRO - CROATIA
7	ZUKIC ADNA		BIH - BOSNIA AND HERZEGOVINA
9	BAICU LORENA MARINA		ROU - ROMANIA

Junior Kumite Female -53 kg			
1	GASHNIKOVA VERONIKA		WKF-1 - WKF-1
2	GONCALVES LEONOR		POR - PORTUGAL
3	HNES MARIIA		UKR - UKRAINE
3	TOROK PANKA		HUN - HUNGARY
5	ILAVSKA KRISTINA		SVK - SLOVAKIA
5	AYERDI ARIZ NAROA		ESP - SPAIN
7	BANKOVIC DANICA		SRB - SERBIA
7	MAMMADOVA FATIMA		AZE - AZERBAIJAN
9	MORAN EMILY		ENG - ENGLAND

Junior Kumite Female -59 kg			
1	SOENDERGAARD HANNAH BATH		DEN - DENMARK
2	SCARFONE MORGANE		FRA - FRANCE
3	LABATSEVICH ALINA		WKF-2 - WKF-2
3	HELLEN ILI		GER - GERMANY
5	BAZYUK VICTORIA		POR - PORTUGAL
5	KRVINA LIA		SLO - SLOVENIA
7	BENESOVA NINA		SVK - SLOVAKIA
7	OLSEN LINA-VIKTORIA SALES		NOR - NORWAY
9	KRIKUN HADAR		ISR - ISRAEL
9	DJUKIC KATARINA		MNE - MONTENEGRO
11	PUSHKOVA ANASTASIIA		UKR - UKRAINE



EKF Junior, Cadet & U21 Championships
2026 - Limassol - 2026-02-06



Official Results

Junior Kumite Female -66 kg			
1	BAULD ELIZE		SCO - SCOTLAND
2	BARANOVA ULIANA		UKR - UKRAINE
3	AHMADZADA JANSU		AZE - AZERBAIJAN
3	LOPEZ GONZALEZ NOA		ESP - SPAIN
5	MILOVANNOVA VALERIA		WKF-1 - WKF-1
5	ARIFAGIC ALMINA		SUI - SWITZERLAND
7	BUKOVSKA LUCIE		CZE - CZECH REPUBLIC
7	ASCIC SEJLA		BIH - BOSNIA AND HERZEGOVINA
9	KULUKHASHVILI MAKI		GEO - GEORGIA
9	CADETE BEATRIZ		POR - PORTUGAL

Junior Kumite Female 66+ kg			
1	RAKOVIC UNA		MNE - MONTENEGRO
2	CORREDDU NICOLE		ITA - ITALY
3	BALUT NATALIA		POL - POLAND
3	KURTANOVIC AJLIN		BIH - BOSNIA AND HERZEGOVINA
5	DAWOUD DALIA		GER - GERMANY
5	KRAPIVINA KIRA		WKF-1 - WKF-1
7	LANBERG ALJONA		EST - ESTONIA
7	KLEWAROVA MARKETA		CZE - CZECH REPUBLIC
9	VALK IMANE		NED - NETHERLANDS

Junior Kumite Male -55 kg			
1	VIECHKANOV MAKSYM		UKR - UKRAINE
2	GANBAROV VUSAL		AZE - AZERBAIJAN
3	TEKUEV ALYI		WKF-1 - WKF-1
3	MONDO BRANCHI MATTEO		ITA - ITALY
5	BALZARIS MIROSLAVS		LAT - LATVIA
5	DAVID GABRIEL MUTU		ROU - ROMANIA
7	MUSTAFA JOSEF		SWE - SWEDEN
7	KRISTENSEN ELIAS MAITSLAND		DEN - DENMARK
9	ALANIA GIGI		GEO - GEORGIA

Junior Kumite Male -61 kg			
1	HORNAK FILIP		CZE - CZECH REPUBLIC
2	MABIC FILIP		CRO - CROATIA
3	ABASOV RAVAN		AZE - AZERBAIJAN
3	DIDIC ISMAIL		BIH - BOSNIA AND HERZEGOVINA
5	VIETRINS MAKSIMS		LAT - LATVIA
5	LEPEZ DEVON		NED - NETHERLANDS
7	DANILOVIC BALS		MNE - MONTENEGRO
7	MANSO ARNAL ADRIAN		ESP - SPAIN
9	WATTS CONNOR		ENG - ENGLAND
9	ZECCA LUCAS		SUI - SWITZERLAND



EKF Junior, Cadet & U21 Championships
2026 - Limassol - 2026-02-06



Official Results

Junior Kumite Male -68 kg			
1	MALIKOV ALADDIN		AZE - AZERBAIJAN
2	STANKOV SERHII		UKR - UKRAINE
3	TAKLIT ANIS		FRA - FRANCE
3	ABULADZE NIKOLOZ		GEO - GEORGIA
5	SIMOTA DAVID		CZE - CZECH REPUBLIC
5	TOMMASINO ALMERICO		ITA - ITALY
7	MIHAYLOV NIKOLA		BUL - BULGARIA
7	JONSSON ARON BUILAM		ISL - ICELAND
9	KARLEN THEO		SUI - SWITZERLAND
9	CRIVAT STEFAN		ROU - ROMANIA
11	RUSTEMI ENDRI		ALB - ALBANIA

Junior Kumite Male -76 kg			
1	TURCANIK RICHARD		SVK - SLOVAKIA
2	DOLOMAN MIHAI CRISTIAN		ROU - ROMANIA
3	ARIFAJ ANES		MNE - MONTENEGRO
3	MAGOMEDALIEV ABDULKADIR		WKF-1 - WKF-1
5	TSANEV NIKOLAY		BUL - BULGARIA
5	BIRAC NIKOLA		CRO - CROATIA
7	PASHOV DJEM		MKD - NORTH MACEDONIA
7	RUZSINSZKI BALAZS		HUN - HUNGARY
9	BLUMINK LEVY		NED - NETHERLANDS
9	TSHIBASSU-SONA ELIE-CHRISTOPHER-ALEX		BEL - BELGIUM
11	WONG-LYE CHRISTOPHER CHUNG YIN		IRL - IRELAND

Junior Kumite Male 76+ kg			
1	VUCINIC VUK		MNE - MONTENEGRO
2	RUDENKO VLADYSLAV		UKR - UKRAINE
3	FERRARINI FRANCESCO		ITA - ITALY
3	SOTIROV BOJIDAR		BUL - BULGARIA
5	AGUIAR ANDRE		POR - PORTUGAL
5	KONJARIA NIKO		GEO - GEORGIA
7	SPAHIC BELMIN		BIH - BOSNIA AND HERZEGOVINA
7	PRZASNYSKI MICHAL		POL - POLAND
9	PEJTERSEN EMIL MARKMANN		DEN - DENMARK
9	BUHURCU JIYAN		SUI - SWITZERLAND

Kata Team Cadet and Junior Female			
1	FRANCE - VORATOVIC ILIANA - VAUCELLE-SPELLE NINON - VILANOVA JULIA - CAPET LOUISE		FRA - FRANCE
2	SPAIN		ESP - SPAIN



EKF Junior, Cadet & U21 Championships
2026 - Limassol - 2026-02-06



Official Results

	- CASTRO LOPEZ ROCIO - FOLGUEIRA GONZALEZ UXIA - PENA GARCIA CANDELA - RODRIGO DIAZ LUCIA			
3	ITALY - DUBLINO BEATRICE - ESPOSITO EMILIA - ORSETTI ANNA - TAGLIABUE SILVIA		ITA - ITALY	
3	WKF-1 - PANTILEEVA ELIZAVETA - KHOSROEVA ALINA - NEMCHENKO ANGELINA - AVANESOVA VERONIKA	WKF	WKF-1 - WKF-1	
5	GERMANY - BAGHDJIAN DANA - GOETHE MARIEL - SCHAUDIG LUISA		GER - GERMANY	
5	SERBIA - ARSIC TEODORA - GRUJANIC IRENA - VALASEK NADJA		SRB - SERBIA	
7	MALTA - AWAD ATTIA JENNA - ROADLEY-BATTIN EVIE - SALIBA FRANCESCA		MLT - MALTA	

Kata Team Cadet and Junior Male

1	ITALY - FREDA MATTEO - NARDACCIO MATTEO - PUTELLI NICOLO - ROSIELLO MARCO		ITA - ITALY	
2	SPAIN - ALVAREZ FERNANDEZ IZAN - CARMONA DIAZ ENRIQUE - GONZALEZ SAEZ HUGO - LEON DE LA PENA JOSE ANGEL		ESP - SPAIN	
3	GERMANY - ATHANASSIAS APOSTOLOS - GSCHWIND VICTOR - KUNIYASU HARUAKI		GER - GERMANY	
3	SLOVAKIA - BABEL BRANISLAV - MACKO PETER - ORAVCIK JURAJ - STUSKA SAMUEL		SVK - SLOVAKIA	
5	POLAND - GRZESLO IGOR - KOLACKOV LEON - MYDLARZ MICHAL - NIEDZIELA MICHAL		POL - POLAND	
5	FRANCE - FRANCES ADRIEN - HUYET-DUMONG THOMAS - PILLANT METIS - RAMDANI MOHAMMED HAROUN		FRA - FRANCE	
7	ISRAEL - DE LEVIE YANNAI - KAUFMAN NETA - RABAN NIV		ISR - ISRAEL	



EKF Junior, Cadet & U21 Championships
2026 - Limassol - 2026-02-06



Official Results

U21 Kata Female			
1	GARCIA LOZANO PAOLA		ESP - SPAIN
2	BUI MAI LINH		FRA - FRANCE
3	MILIC JOVANA		MNE - MONTENEGRO
3	DOMINICI ROBERTA		ITA - ITALY
5	WYSOCKA EMILIA		POL - POLAND
5	KHURTSILAVA LIA		GEO - GEORGIA
7	DAHL-WROENDING JUSTINA		DEN - DENMARK
7	STOJKOVA DANKA		MKD - NORTH MACEDONIA

U21 Kata Male			
1	MARTIN MONTENEGRO IVAN		ESP - SPAIN
2	VU ANTHONY		SWE - SWEDEN
3	PAPPALARDO VINCENZO		ITA - ITALY
3	VIEIRA JOAO		POR - PORTUGAL
5	MODI ALEXANDRU NICOLAS		ROU - ROMANIA
5	ZLABEK JAKUB		CZE - CZECH REPUBLIC
7	HOFFMANN LUCAS		FRA - FRANCE
7	KODAJ SIMON		SVK - SLOVAKIA
9	CHAFFORT LUCAS		LUX - LUXEMBOURG

U21 Kata Team Female			
1	CZECH REPUBLIC - KIRSCHNEROVA ALICE-JANA - MALAFOVA NATALIE - NOVAKOVA KATERINA - ONDROUSKOVA AMALIE		CZE - CZECH REPUBLIC
2	SPAIN - ANGULO MADRID ABRIL - GARCIA LOZANO PAOLA - GUARDENO LEON CARLA - MARTIN DIAZ ALBA		ESP - SPAIN
3	GERMANY - EWALD CLARA - JUERGENSMANN ANNIKA - STEVENS JULIE		GER - GERMANY
3	ITALY - CRUCITTI FRANCESCA - DE GREGORIO GABRIELLA - DOMINICI ROBERTA - PADOAN MARTINA		ITA - ITALY

U21 Kata Team Male			
1	ITALY - DI RUBBA LUIGI - MATAcCHIONI LUIGI - PAPPALARDO VINCENZO - SERGI FRANCESCO		ITA - ITALY
2	FRANCE - COURTOIS TOM - HOFFMANN LUCAS - PELTIER TOM		FRA - FRANCE
3	AUSTRIA		AUT - AUSTRIA



EKF Junior, Cadet & U21 Championships
2026 - Limassol - 2026-02-06



Official Results

	- WU TIMON - ZOECHLING FLORIAN - WAGNER FELIX			
3	SPAIN - GALAN LACON ALEJANDRO - LOPEZ TOMAS IZAN - LOPEZ VILLANUEVA JUAN MANUEL - MARTIN MONTENEGRO IVAN		ESP - SPAIN	
5	GERMANY - BECKER SEBASTIAN - HADIZADEH JULIAN - LUECK ANDREW LYLE		GER - GERMANY	

U21 Kumite Female -50 kg

1	MARKAVA ULYANA		WKF-2 - WKF-2	
2	LEGITTIMO LUDOVICA		ITA - ITALY	
3	DAVYDOVA VICTORIA		WKF-1 - WKF-1	
3	NYMAN AGNES		SWE - SWEDEN	
5	NASTAS PATRICIA		ROU - ROMANIA	
5	VIZUETE OLIVENZA MIREIA		ESP - SPAIN	
7	MISHOVSKA MIHAELA		MKD - NORTH MACEDONIA	
7	COCHARD LOLA		FRA - FRANCE	

U21 Kumite Female -55 kg

1	KVASNICOVA NINA		SVK - SLOVAKIA	
2	BACKOVIC HELENA		MNE - MONTENEGRO	
3	LIUTKEVICIUTE MIGLE		LTU - LITHUANIA	
3	ABDESSELEM SYLIA		FRA - FRANCE	
5	MEHANIJA HENA		BIH - BOSNIA AND HERZEGOVINA	
5	ZVIAGINTSEVA OLGA		WKF-1 - WKF-1	
7	VOORDUIN ALYSSIA		NED - NETHERLANDS	
7	PANCHEVA MILA		MKD - NORTH MACEDONIA	
9	JADIN LANA		LUX - LUXEMBOURG	

U21 Kumite Female -61 kg

1	GIRVICA BEATA		LAT - LATVIA	
2	BASANGOVA ALTANA		WKF-1 - WKF-1	
3	ARZUMIAN MONICA		FRA - FRANCE	
3	FILIPOV NEVENA		SRB - SERBIA	
5	SEMENENKO ANASTASIIA		GER - GERMANY	
5	MAKARENKO VIOLETTA		UKR - UKRAINE	
7	MARTURANO IRENE		ITA - ITALY	
7	VACZY ANNA		SVK - SLOVAKIA	
9	PRIGLOVA MARIE		CZE - CZECH REPUBLIC	
9	MICOVSKA JOVANA		MKD - NORTH MACEDONIA	

U21 Kumite Female -68 kg

1	KATSIKA EIRINI-GRIGORIA		GRE - GREECE	
2	KRSTOVIC TEODORA		SRB - SERBIA	
3	SIPOVIC AJLA		BIH - BOSNIA AND HERZEGOVINA	



EKF Junior, Cadet & U21 Championships
2026 - Limassol - 2026-02-06



Official Results

3	JUST CLOPES JULIA		ESP - SPAIN	
5	ZWANENBURG ROBIN		NED - NETHERLANDS	
5	DESIDERIO ANNA PIA		ITA - ITALY	
7	KOXHA ERA		MKD - NORTH MACEDONIA	
7	FRATILA CRISTINA-MARIA		GER - GERMANY	
9	IVASCU LARISA ADRIANA		ROU - ROMANIA	

U21 Kumite Female 68+ kg

1	BULAY DARIIA		UKR - UKRAINE	
2	FLEISCHER DORA		HUN - HUNGARY	
3	TOMIC SARA		CRO - CROATIA	
3	HAKOVA AMALIE		CZE - CZECH REPUBLIC	
5	BATH ASTAMAJA		DEN - DENMARK	
5	ZIBERI ERDONA		MKD - NORTH MACEDONIA	
7	RAJIC DUNJA		SRB - SERBIA	
7	GULLAN SOFIA HELENA ENGMAN		SWE - SWEDEN	

U21 Kumite Male -60 kg

1	VOJINOVIC BALS		MNE - MONTENEGRO	
2	SQUILLANTE GUIDO		ITA - ITALY	
3	ABDELMALKI AMIN		BEL - BELGIUM	
3	DOSTUYEV ASLAN		AZE - AZERBAIJAN	
5	CHRENKO JAN		SVK - SLOVAKIA	
5	OLIVEIRA GUSTAVO		POR - PORTUGAL	
7	KALLESTRUP MARIUS		DEN - DENMARK	
7	JOST RUBEN		SUI - SWITZERLAND	
9	OBITZ FLORIAN		GER - GERMANY	
9	MILENKOVIC BOGDAN		SRB - SERBIA	

U21 Kumite Male -67 kg

1	BELISTOJANOSKI MATEJ		MKD - NORTH MACEDONIA	
2	BALLOTIS GEORGIOS		GRE - GREECE	
3	GALLAGHER JOE		SCO - SCOTLAND	
3	TOTH ZSOMBOR		HUN - HUNGARY	
5	PRANNYCHUK NAZARII		UKR - UKRAINE	
5	GIORDANO FABRIZIO		ITA - ITALY	
7	EJJA AMINE		BEL - BELGIUM	
7	DJURCEVIC LAZAR		MNE - MONTENEGRO	
9	BAHAMOLETS MIKITA		WKF-2 - WKF-2	
9	TSANGARAS ALEXIS		CYP - CYPRUS	
11	RAMI RIGERS		ALB - ALBANIA	

U21 Kumite Male -75 kg

1	SECKAR SIMON		SVK - SLOVAKIA	
2	FRANKEN RICARDO		NED - NETHERLANDS	
3	PITSUL HEORHII		UKR - UKRAINE	
3	GADZHIEV GADZHI		WKF-1 - WKF-1	



EKF Junior, Cadet & U21 Championships
2026 - Limassol - 2026-02-06



Official Results

5	SHOTTE CABELLO ZSAMORAN		ESP - SPAIN	
5	HRIHORASHENKO MYKYTA		AUT - AUSTRIA	
7	MIHAJLOV LJUPCHE		MKD - NORTH MACEDONIA	
7	STRAHIJA SVEN		CRO - CROATIA	
9	AINSCOUGH LEE		IRL - IRELAND	
9	KALVANS DENISS		LAT - LATVIA	
11	ALEXANDRE CARDOSO INACIO DIOGO		POR - PORTUGAL	

U21 Kumite Male -84 kg

1	BOHUNICKY LUKAS		SVK - SLOVAKIA	
2	PALJEVAC SINAN		BIH - BOSNIA AND HERZEGOVINA	
3	PSOMAS ILIAS		GRE - GREECE	
3	HALLDORSSON HUGI		ISL - ICELAND	
5	PIANTKIVSKYI DENYS		UKR - UKRAINE	
5	PEZZOTTI GABRIELE		ITA - ITALY	
7	WOZNIAK KAJETAN		POL - POLAND	
7	BOLOTSKIHH SAVELI		EST - ESTONIA	
9	LISAL DAVID		HUN - HUNGARY	
9	PUKE ROBERTS		LAT - LATVIA	

U21 Kumite Male 84+ kg

1	DAVIES ALEXANDER		LUX - LUXEMBOURG	
2	KOZYLIAN OLEKSANDR		UKR - UKRAINE	
3	JADOUL ERWAN		BEL - BELGIUM	
3	CASSAMA JOSE		POR - PORTUGAL	
5	TADJER ADAM		FRA - FRANCE	
5	BURROSI SAMUELE		ITA - ITALY	
7	POTPARA LAZAR		MNE - MONTENEGRO	
7	KIRYLUK PAWEL		POL - POLAND	
9	VASILE DAVID GABRIEL		ROU - ROMANIA	
9	HOXHAI VILSJAN		ALB - ALBANIA	

MEDAL STANDING



EKF Junior, Cadet & U21 Championships
2026 - Limassol - 2026-02-06



Medals - National Federation

Rank	National Federation	1. Place	2. Place	3. Place
1	UKRAINE, UKR	4	7	2
2	SLOVAKIA, SVK	4	0	4
3	ITALY, ITA	3	6	6
4	SPAIN, ESP	3	4	7
5	PORTUGAL, POR	3	2	3
6	MONTENEGRO, MNE	3	2	2
7	WKF-1, WKF-1	2	3	7
8	GREECE, GRE	2	1	2
9	SCOTLAND, SCO	2	0	2
	GEORGIA, GEO	2	0	2
11	CZECH REPUBLIC, CZE	2	0	1
12	FRANCE, FRA	1	3	5
13	AZERBAIJAN, AZE	1	1	4
14	ROMANIA, ROU	1	1	3
15	NORTH MACEDONIA, MKD	1	1	0
16	LATVIA, LAT	1	0	2
17	WKF-2, WKF-2	1	0	1
	BULGARIA, BUL	1	0	1
19	DENMARK, DEN	1	0	0
	LUXEMBOURG, LUX	1	0	0
21	CROATIA, CRO	0	1	3
	BOSNIA AND HERZEGOVINA, BIH	0	1	3
23	HUNGARY, HUN	0	1	2
	BELGIUM, BEL	0	1	2
25	SWEDEN, SWE	0	1	1
	SERBIA, SRB	0	1	1
	ALBANIA, ALB	0	1	1
28	NETHERLANDS, NED	0	1	0
29	GERMANY, GER	0	0	5
30	POLAND, POL	0	0	2
31	CYPRUS, CYP	0	0	1
	AUSTRIA, AUT	0	0	1
	ICELAND, ISL	0	0	1
	LITHUANIA, LTU	0	0	1