

RESULT BOOK

30TH BALKAN KARATE CHAMPIONSHIPS FOR CHILDREN

2026 - ISTANBUL

2026.05.29 - 2026.05.31

BASAKSEHIR SPOR HALL, KAYABAŞI, TINAZTEPE CADDESİ NO:6, 34494

BAŞAKŞEHİR, İSTANBUL

TURKIYE, TUR

TABLE OF CONTENTS

NUMBER OF ENTRIES.....	4
NUMBER OF ENTRIES BY CONTINENT.....	5
ENTRYLIST.....	7
STATISTICS.....	46
OFFICIAL RESULTS.....	216
MEDAL STANDING.....	233

A world map is rendered in a dark blue, dotted style, centered on the page. The background is a dark blue gradient with dynamic, glowing red and blue light streaks and a hexagonal pattern in the corners.

NUMBER OF ENTRIES













30th Balkan Karate Championships for Children 202 ..

TURKIYE

2026.05.29 - 2026.05.31

Basaksehir Spor Hall, Kayabaşı, TINAZTEPE CADDESİ NO:6, 34494 Başakşehir, İstanbul

NUMBER OF ENTRIES

#	Code	National Federation	Male Entries	Female Entries	Total Entries	Total Athletes
1		ALB ALBANIA	9	3	12	12
2		BIH BOSNIA AND HERZEGOVINA	110	111	221	219
3		BUL BULGARIA	78	80	158	120
4		CRO CROATIA	41	63	104	102
5		CYP CYPRUS	1	1	2	2
6		GRE GREECE	89	104	193	165
7		KOS KOSOVO	25	24	49	46
8		MNE MONTENEGRO	92	103	195	182
9		MKD NORTH MACEDONIA	38	23	61	54
10		ROU ROMANIA	21	46	67	60
11		SRB SERBIA	112	112	224	216
12		SLO SLOVENIA	1	1	2	2
13		TUR TURKIYE	188	188	376	388
Totals:			805	859	1664	1568

NUMBER OF ENTRIES BY CONTINENT

30th Balkan Karate Championships for Children 2026 - Istanbul

As of 31 MAY 2026

Code	Continent / National Federation	Male Entries	Female Entries	Total Entries	Total Athletes
	EUROPE				
ALB	ALBANIA	9	3	12	12
BIH	BOSNIA AND HERZEGOVINA	110	111	221	219
BUL	BULGARIA	78	80	158	120
CRO	CROATIA	41	63	104	102
CYP	CYPRUS	1	1	2	2
GRE	GREECE	89	104	193	165
KOS	KOSOVO	25	24	49	46
MNE	MONTENEGRO	92	103	195	182
MKD	NORTH MACEDONIA	38	23	61	54
ROU	ROMANIA	21	46	67	60
SRB	SERBIA	112	112	224	216
SLO	SLOVENIA	1	1	2	2
TUR	TURKIYE	188	188	376	388
Total	EUROPE	13	805	859	1,664
Total		13	805	859	1,664

A world map graphic rendered in a blue dot-matrix style, centered on the page. The map is set against a background of dynamic, glowing red and blue light streaks and a hexagonal grid pattern.

ENTRYLIST

30th Balkan Karate Championships for Children 202 ..

ENTRIES BY NATIONAL FEDERATION

As of 31 MAY 2026

Code	ID	Gender	Name	Event	Seeding
ALB	ALB002725	M	ABAZAJ REDIS	13 Yrs Kumite Male -40 kg	
	ALB002849	M	CANI LUIS	11 Yrs Kumite Male -45 kg	
	ALB002850	M	DEDEJ ALVIN	10 Yrs Kumite Male -45 kg	
	ALB002729	M	GOSA OMAR	12 Yrs Kumite Male 52+ kg	
	ALB002774	M	HASANI SIVEN	12 Yrs Kumite Male -37 kg	
	ALB002770	M	KARAJ ARVI	11 Yrs Kumite Male -45 kg	
	ALB002727	M	PUSHAJ ANSEL	12 Yrs Kumite Male 52+ kg	
	ALB002723	M	SHTARO FATJON	13 Yrs Kumite Male -50 kg	
	ALB002773	M	SINANI ANAID	11 Yrs Kumite Male 50+ kg	
	ALB002772	F	BAHJA AJLA	11 Yrs Kumite Female -32 kg	
	ALB02575	F	BAHJA EMILI	13 Yrs Kumite Female -39 kg	
	ALB002851	F	SULAJ JEHONA	10 Yrs Kumite Female -30 kg	
BIH	BIH03679	M	ADILOVIC HAMZA	13 Yrs Kumite Male -50 kg	
	BIH004648	M	AHMETAGIC IMRAN	10 Yrs Kata Individual Male	
	BIH004672	M	AHMETOVIC ALI SABAN	12 Yrs Kumite Male -37 kg	
	BIH005083	M	AKELJIC HAMZA	11 Yrs Kumite Male 50+ kg	
	BIH04377	M	AKSAMOVIC ELMEDIN	13 Yrs Kumite Male -55 kg	
	BIH004698	M	ALIBEGOVIC EMRAH	13 Yrs Kumite Male 55+ kg	
	BIH005332	M	ALJOSA SIKMAN	10 Yrs Kumite Male -45 kg	
	BIH005364	M	BABIC HAMZA	13 Yrs Kumite Male -45 kg	
	BIH004687	M	BABIC JOVAN	12 Yrs Kumite Male 52+ kg	
	BIH005319	M	BABIC MIHAILO	10 Yrs Kumite Male -35 kg	
	BIH005048	M	BASIC INDIR	13 Yrs Kata Individual Male	
	BIH004665	M	BEGANOVIC ARIS	10 Yrs Kata Individual Male	
	BIH005139	M	BERBIC IBRAHIM DZAN	12 Yrs Kata Individual Male	
	BIH005337	M	BORIC MARKO	11 Yrs Kumite Male -35 kg	
	BIH004682	M	BUJIC NJEGOS	12 Yrs Kumite Male 52+ kg	
	BIH005078	M	BUKVA HARUN	11 Yrs Kumite Male -50 kg	
	BIH005338	M	BUNCIC SERGEJ	11 Yrs Kumite Male -35 kg	
	BIH04372	M	BUNDA AHMED	13 Yrs Kumite Male -40 kg	
	BIH005396	M	CIBRIC BILAL	13 Yrs Kumite Male -45 kg	
	BIH005077	M	CRLJIC ADRIJAN	11 Yrs Kumite Male -45 kg	
	BIH005347	M	DAVIDOVIC VIKTOR	11 Yrs Kumite Male 50+ kg	
	BIH005049	M	DELIC HAMZA	13 Yrs Kata Individual Male	
	BIH005049	M	DELIC HAMZA	13 Yrs Kumite Male -50 kg	
	BIH005075	M	DJIDIC BILAL	11 Yrs Kumite Male -40 kg	
	BIH005086	M	DJURDJEVIC VELJKO	11 Yrs Kumite Male 50+ kg	
	BIH005333	M	DOBRAS KONSTANTIN	10 Yrs Kumite Male 45+ kg	
	BIH005126	M	DOJCINOVIC MILAN	11 Yrs Kumite Male -35 kg	
	BIH005354	M	DOSLOV MIHAJLO	12 Yrs Kumite Male -52 kg	
	BIH005316	M	DRAGOJEVIC PAVLE	10 Yrs Kumite Male -30 kg	
	BIH03705	M	FAZLIC KAAAN	13 Yrs Kata Individual Male	
	BIH005295	M	FERHATBEGOVIC ADI	8 Yrs Kata Individual Male	
	BIH005295	M	FERHATBEGOVIC ADI	8-9 Yrs Kata Team Male	
	BIH005052	M	FERHATOVIC DAVUD	8-9 Yrs Kata Team Male	
	BIH004618	M	GACESA LUKA	12 Yrs Kumite Male 52+ kg	
	BIH005046	M	GORDIC BOGDAN	10 Yrs Kumite Male -35 kg	

30th Balkan Karate Championships for Children 202 ..

ENTRIES BY NATIONAL FEDERATION

As of 31 MAY 2026

Code	ID	Gender	Name	Event	Seeding
BIH	BIH04371	M	HACAMOVIC RIJAD	13 Yrs Kumite Male -40 kg	
	BIH005370	M	HADZIMESIC IRFAN	13 Yrs Kumite Male -55 kg	
	BIH04350	M	HALILOVIC OMER	11 Yrs Kata Individual Male	
	BIH005309	M	HASANBASIC KAAAN	12 Yrs Kata Individual Male	
	BIH005300	M	HODZIC DARIS	9 Yrs Kata Individual Male	
	BIH005329	M	HRUSTANOVIC AHMED	10 Yrs Kumite Male -45 kg	
	BIH04375	M	HUSIC DENIAL	13 Yrs Kumite Male 55+ kg	
	BIH04348	M	IBRIC ARIF	11 Yrs Kata Individual Male	
	BIH005346	M	IMSIROVIC ADIN	11 Yrs Kumite Male 50+ kg	
	BIH004640	M	ISLAMCEVIC ELVIN	12 Yrs Kumite Male -42 kg	
	BIH004649	M	JASAREVIC NAZIF	11 Yrs Kata Individual Male	
	BIH005297	M	JASAREVIC REDZEP	8 Yrs Kata Individual Male	
	BIH005356	M	JASIC ADIN	13 Yrs Kumite Male -40 kg	
	BIH005352	M	JAZVIN DENNY	12 Yrs Kumite Male -47 kg	
	BIH005343	M	JOKIC ADRIJAN	11 Yrs Kumite Male -50 kg	
	BIH005095	M	JOSIC UROS	13 Yrs Kumite Male -45 kg	
	BIH005117	M	JUSUFOVIC TARIK	11 Yrs Kumite Male -45 kg	
	BIH004735	M	KALINKOV SERGEJ	12 Yrs Kumite Male 52+ kg	
	BIH004692	M	KALOPER MUHAMED	12 Yrs Kumite Male -52 kg	
	BIH005100	M	KEKIC EMAN	13 Yrs Kumite Male 55+ kg	
	BIH005050	M	KOVACEVIC KENAN	13 Yrs Kata Individual Male	
	BIH004674	M	KULIC EMIR	12 Yrs Kata Individual Male	
	BIH005142	M	LISICA RIJAD	13 Yrs Kumite Male 55+ kg	
	BIH005042	M	MAHMUTAGIC OMAR	9 Yrs Kata Individual Male	
	BIH005080	M	MAKSIMOVIC MIHAJLO	11 Yrs Kumite Male -50 kg	
	BIH005097	M	MARCETA PETAR	13 Yrs Kumite Male -40 kg	
	BIH005317	M	MARIC DARIS	10 Yrs Kumite Male -30 kg	
	BIH005054	M	MEHMEDOVIC ADEMIR	8-9 Yrs Kata Team Male	
	BIH005350	M	MEMOVIC VEDAD	12 Yrs Kumite Male -42 kg	
	BIH004686	M	MILESEVIC VELJKO	12 Yrs Kumite Male -37 kg	
	BIH005341	M	MIRJANIC MILAN	11 Yrs Kumite Male -40 kg	
	BIH005345	M	MITROVIC NEMANJA	11 Yrs Kumite Male -50 kg	
	BIH005098	M	MORACA VIKTOR	13 Yrs Kumite Male -50 kg	
	BIH005351	M	MUHAMMED AHMED	12 Yrs Kumite Male -47 kg	
	BIH005339	M	MUHAREMOVIC KENAN	11 Yrs Kumite Male -40 kg	
	BIH005047	M	MUHIC ARMEND	10 Yrs Kumite Male -35 kg	
	BIH004621	M	MUJEZINOVIC IMRAN	13 Yrs Kumite Male 55+ kg	
	BIH005323	M	MUJKANOVIC HARUN	10 Yrs Kumite Male -40 kg	
	BIH005074	M	MURANOVIC DARIS	11 Yrs Kumite Male -40 kg	
	BIH005334	M	MURTIC DZAN	10 Yrs Kumite Male 45+ kg	
	BIH005328	M	MUSIC ALEKSEJ	10 Yrs Kumite Male -45 kg	
	BIH005092	M	MUSOVIC MUHAMED	12 Yrs Kumite Male -52 kg	
	BIH005426	M	NEDJIC NIKOLA	10 Yrs Kumite Male 45+ kg	
	BIH005298	M	ORESKOVIC DEAN	8 Yrs Kata Individual Male	
	BIH005298	M	ORESKOVIC DEAN	8-9 Yrs Kata Team Male	
	BIH005045	M	OSMANOVIC ALEM	9 Yrs Kata Individual Male	
	BIH005296	M	PANDZIC HARUN	8 Yrs Kata Individual Male	
	BIH005313	M	PANIC ISAK	10 Yrs Kumite Male -30 kg	

30th Balkan Karate Championships for Children 202 ..

ENTRIES BY NATIONAL FEDERATION

As of 31 MAY 2026

Code	ID	Gender	Name	Event	Seeding
BIH	BIH04378	M	PANIC NIKOLA	13 Yrs Kumite Male -55 kg	
	BIH004627	M	PENO NESTOR	13 Yrs Kumite Male -55 kg	
	BIH005355	M	PETROVIC STEFAN	12 Yrs Kumite Male 52+ kg	
	BIH005304	M	PETROVIC TEODOR	10 Yrs Kata Individual Male	
	BIH005304	M	PETROVIC TEODOR	10-11 Yrs Kata Team Male	
	BIH005303	M	RADAKOVIC MATIJA	10 Yrs Kata Individual Male	
	BIH005303	M	RADAKOVIC MATIJA	10-11 Yrs Kata Team Male	
	BIH005340	M	RAJILIC FILIP	11 Yrs Kumite Male -40 kg	
	BIH005335	M	ROGO DANIN	10 Yrs Kumite Male 45+ kg	
	BIH005114	M	SALAMOVIC ABDULAH	11 Yrs Kumite Male -35 kg	
	BIH04416	M	SALKIC ALDIN	13 Yrs Kata Individual Male	
	BIH04374	M	SARAJLIC TARIK	13 Yrs Kumite Male -50 kg	
	BIH005306	M	SAVANOVIC ANDRIJA	10 Yrs Kata Individual Male	
	BIH005088	M	SEKULIC GAVRILO	12 Yrs Kumite Male -37 kg	
	BIH004666	M	SEMIC ARMAN	11 Yrs Kata Individual Male	
	BIH005348	M	SILJ PAVLE	12 Yrs Kumite Male -37 kg	
	BIH004684	M	SKORIC ANDREJ	12 Yrs Kumite Male -52 kg	
	BIH004712	M	SKRBO NIKOLA	13 Yrs Kumite Male -55 kg	
	BIH005331	M	SPAHIC DANIN	9 Yrs Kata Individual Male	
	BIH005325	M	STAMBOLIC DZANAN	10 Yrs Kumite Male -40 kg	
	BIH005322	M	SULJIC BILAL	10 Yrs Kumite Male -40 kg	
	BIH005363	M	SULJIC FARIS	10 Yrs Kumite Male -40 kg	
	BIH005301	M	TALIC DINO	9 Yrs Kata Individual Male	
	BIH004630	M	TATAREVIC DAVUD	12 Yrs Kata Individual Male	
	BIH005305	M	TIHAK ARMAN	10 Yrs Kumite Male -35 kg	
	BIH005079	M	TOKIC AHMED	11 Yrs Kumite Male -45 kg	
	BIH005318	M	VASIC NEMANJA	10 Yrs Kumite Male -30 kg	
	BIH005342	M	VRETO VANJA	11 Yrs Kumite Male -45 kg	
	BIH004652	M	VUJIN ALEKSA	12 Yrs Kumite Male -42 kg	
	BIH005349	M	ZILIC KERIM	12 Yrs Kumite Male -42 kg	
	BIH005330	M	ZJAKIC HARUN	10 Yrs Kumite Male -45 kg	
	BIH005409	M	ZORIC ANDREJ	10-11 Yrs Kata Team Male	
	BIH005403	F	ADILOVIC DZEJNA	11 Yrs Kumite Female -32 kg	
	BIH03965	F	ADILOVIC ZAHRA	12 Yrs Kata Individual Female	
	BIH03965	F	ADILOVIC ZAHRA	12 Yrs Kumite Female -35 kg	
	BIH005385	F	AHMETAGIC MEDINA	13 Yrs Kata Individual Female	
	BIH005067	F	AHMETAGIC NADJA	13 Yrs Kata Individual Female	
	BIH005061	F	AJKUNIC ZARA	9 Yrs Kata Individual Female	
	BIH005034	F	BESLIJA MEDINA	13 Yrs Kumite Female 54+ kg	
	BIH04434	F	BESO EJNA	11 Yrs Kata Individual Female	
	BIH04336	F	BOSNJAK MERJEM	13 Yrs Kumite Female 54+ kg	
	BIH005408	F	BURSAC MATEA	11 Yrs Kumite Female -36 kg	
	BIH005020	F	CAUSEVIC AMILA	12 Yrs Kumite Female -40 kg	
	BIH04364	F	CAUSEVIC ZARA	12 Yrs Kumite Female -40 kg	
	BIH004717	F	DEMIROVIC LAMIJA	13 Yrs Kumite Female -49 kg	
	BIH04331	F	DJUKIC IVANA	13 Yrs Kumite Female -54 kg	
	BIH005005	F	DOJCINOVIC IVANA	11 Yrs Kumite Female -40 kg	
	BIH004614	F	GOGIC ILMA	10 Yrs Kata Individual Female	

30th Balkan Karate Championships for Children 202 ..

ENTRIES BY NATIONAL FEDERATION

As of 31 MAY 2026

Code	ID	Gender	Name	Event	Seeding
BIH	BIH004614	F	GOGIC ILMA	10 Yrs Kumite Female -30 kg	
	BIH004675	F	HADZIC ADELA	10 Yrs Kata Individual Female	
	BIH005377	F	HAJDUKOVIC DUNJA	10 Yrs Kumite Female 40+ kg	
	BIH005071	F	HALILOVIC IRMA	10 Yrs Kumite Female 40+ kg	
	BIH005367	F	HALILOVIC NEJRA	12 Yrs Kumite Female -50 kg	
	BIH005359	F	HASANOVIC SAFIJA	8 Yrs Kata Individual Female	
	BIH005065	F	HASELJIC MERJEMA	11 Yrs Kata Individual Female	
	BIH005019	F	HIDIC EJNA	12 Yrs Kumite Female -35 kg	
	BIH004654	F	HIDIC NASIHA	12 Yrs Kumite Female -35 kg	
	BIH005395	F	HODZIC AJLA	9 Yrs Kata Individual Female	
	BIH005421	F	HODZIC DELILA	10 Yrs Kumite Female -37 kg	
	BIH005390	F	HODZIC IMAN	12 Yrs Kumite Female -35 kg	
	BIH005111	F	HODZIC LAJLA	12 Yrs Kumite Female -40 kg	
	BIH04085	F	HRUSTANOVIC MERJEM	12 Yrs Kumite Female -50 kg	
	BIH005024	F	HRUSTIC IMAN	12 Yrs Kumite Female -50 kg	
	BIH004690	F	HUSANOVIC UMA	13 Yrs Kumite Female -54 kg	
	BIH005361	F	IBRANOVIC AMINA	10 Yrs Kumite Female -37 kg	
	BIH005064	F	IDRIZOVIC ALINA	10 Yrs Kata Individual Female	
	BIH04363	F	ILIC SOFIJA	11 Yrs Kata Individual Female	
	BIH005014	F	IMSIROVIC SARA	11 Yrs Kumite Female -44 kg	
	BIH005405	F	IMSIROVIC SARA	8 Yrs Kata Individual Female	
	BIH005405	F	IMSIROVIC SARA	8-9 Yrs Kata Team Female	
	BIH005378	F	JAKOVLJEVIC KALINA	8 Yrs Kata Individual Female	
	BIH004999	F	JASAREVIC EMINA	11 Yrs Kumite Female -36 kg	
	BIH04365	F	JURIC NIKA	13 Yrs Kata Individual Female	
	BIH04365	F	JURIC NIKA	12-13 Yrs Kata Team Female	
	BIH005023	F	KADRIC NAJRA	12 Yrs Kumite Female -45 kg	
	BIH005425	F	KARIC NEJLA	10 Yrs Kumite Female -34 kg	
	BIH04410	F	KASUMOVIC MERJEM	13 Yrs Kumite Female -39 kg	
	BIH005404	F	KAVGIC NELA	8-9 Yrs Kata Team Female	
	BIH005362	F	KECO ILMA	12 Yrs Kumite Female -45 kg	
	BIH004732	F	KORJENIC AJLA	12 Yrs Kumite Female 50+ kg	
	BIH005388	F	KREMO EMINA	9 Yrs Kata Individual Female	
	BIH005002	F	KRIVDIC NEJRA	11 Yrs Kumite Female -36 kg	
	BIH004646	F	LETIC NATASA	12 Yrs Kumite Female -40 kg	
	BIH04360	F	LIVNJAK IMAN	11 Yrs Kumite Female -36 kg	
	BIH005375	F	LUGONJA EMILIJA	10 Yrs Kumite Female -40 kg	
	BIH005389	F	MAHMUTOVIC FARAH	9 Yrs Kata Individual Female	
	BIH005401	F	MALICEVIC AJSA	10 Yrs Kumite Female -30 kg	
	BIH004655	F	MANGIC NEJLA	12 Yrs Kumite Female 50+ kg	
	BIH005400	F	MARKOVIC DONKA	13 Yrs Kumite Female -49 kg	
	BIH004664	F	MILJKOVIC NAJRA	12 Yrs Kumite Female -45 kg	
	BIH005035	F	MILUNIC IVANA	13 Yrs Kumite Female 54+ kg	
	BIH005360	F	MUHAREMOVIC SEMINA	10 Yrs Kumite Female -34 kg	
	BIH004998	F	MUHIC IMAN	11 Yrs Kumite Female -40 kg	
	BIH005011	F	MUJAGIC AZRA	11 Yrs Kumite Female 44+ kg	
	BIH004641	F	MUJEZINOVIC ESMA	12 Yrs Kumite Female -50 kg	
	BIH005072	F	MUJKIC AJNA	10 Yrs Kumite Female -37 kg	

30th Balkan Karate Championships for Children 202 ..

ENTRIES BY NATIONAL FEDERATION

As of 31 MAY 2026

Code	ID	Gender	Name	Event	Seeding
BIH	BIH005358	F	MUJKIC MELIKA	13 Yrs Kumite Female -49 kg	
	BIH005382	F	MUJKIC SAJRA	10 Yrs Kumite Female -37 kg	
	BIH005371	F	MUMINOVIC MIRNA	10 Yrs Kumite Female -40 kg	
	BIH005402	F	MURATHODZIC HANA	11 Yrs Kumite Female -44 kg	
	BIH005387	F	MUSINOVIC AMINA	13 Yrs Kumite Female 54+ kg	
	BIH005407	F	NIKOLINA INA IVKOVIC	11 Yrs Kumite Female -32 kg	
	BIH005394	F	NISIC NEJRA	13 Yrs Kumite Female -39 kg	
	BIH005029	F	PASALIC AJLA	13 Yrs Kumite Female -44 kg	
	BIH03724	F	PASIC KARLA	13 Yrs Kumite Female -39 kg	
	BIH005369	F	PESTEK AJLA	10 Yrs Kumite Female -30 kg	
	BIH005000	F	PETRAS JULIJA	11 Yrs Kumite Female -32 kg	
	BIH005368	F	PLEJIC STEFANI	11 Yrs Kumite Female -40 kg	
	BIH005372	F	POPIC MARIJA	12 Yrs Kumite Female -45 kg	
	BIH004715	F	POPIC MELITA	13 Yrs Kumite Female -44 kg	
	BIH005381	F	PROSJANOVIC SAJRA	10 Yrs Kumite Female -30 kg	
	BIH005374	F	RACA MILICA	13 Yrs Kumite Female -54 kg	
	BIH005016	F	RADIC BOZANA	11 Yrs Kumite Female 44+ kg	
	BIH005399	F	RADOVANOVIC MIHAELA	13 Yrs Kumite Female -49 kg	
	BIH005386	F	RAJKOVIC ANA	11 Yrs Kumite Female -44 kg	
	BIH005392	F	RAMADANI ALMINA	10 Yrs Kumite Female -34 kg	
	BIH005391	F	RAMIC ELIF	12 Yrs Kumite Female -45 kg	
	BIH005406	F	SALKIC EHLIMANA	8-9 Yrs Kata Team Female	
	BIH04417	F	SINANOVIC MUNIBA	13 Yrs Kumite Female -44 kg	
	BIH005357	F	SORO KANITA	13 Yrs Kumite Female -54 kg	
	BIH005366	F	SOSE LEJLA	12 Yrs Kata Individual Female	
	BIH005015	F	STJEPANOVIC ANA MARIJA	11 Yrs Kumite Female 44+ kg	
	BIH005123	F	SUSIC HANA	13 Yrs Kumite Female -39 kg	
	BIH005006	F	SUSIC SARA	11 Yrs Kumite Female -40 kg	
	BIH005036	F	TADIC BOJANA	13 Yrs Kumite Female 54+ kg	
	BIH005428	F	TADIC SOFIJA	10 Yrs Kumite Female 40+ kg	
	BIH005027	F	TAHIROVIC AMINA	12 Yrs Kumite Female 50+ kg	
	BIH03977	F	TALIC LEJLA	13 Yrs Kumite Female -49 kg	
	BIH005069	F	TOMIC ANTEA	13 Yrs Kata Individual Female	
	BIH005069	F	TOMIC ANTEA	12-13 Yrs Kata Team Female	
	BIH005137	F	TOMIC UNA	10-11 Yrs Kata Team Female	
	BIH005427	F	TOSIC KATJA	13 Yrs Kumite Female -39 kg	
	BIH005383	F	TRAKO EMA	10 Yrs Kumite Female -40 kg	
	BIH005373	F	VARDO JASMINA	10 Yrs Kata Individual Female	
	BIH005384	F	VELJIC VERONIKA	8 Yrs Kata Individual Female	
	BIH005009	F	VELJIC VIKTORIJA	11 Yrs Kumite Female -44 kg	
	BIH005009	F	VELJIC VIKTORIJA	10-11 Yrs Kata Team Female	
	BIH005398	F	VIDIOVIC VIKTORIJA	10 Yrs Kumite Female -34 kg	
	BIH005410	F	VILIC ANA	12 Yrs Kata Individual Female	
	BIH005410	F	VILIC ANA	12-13 Yrs Kata Team Female	
	BIH005376	F	VUCKIC HANA	11 Yrs Kumite Female -32 kg	
	BIH005380	F	VUJIN ANDJELIJA	10 Yrs Kumite Female 40+ kg	
	BIH005017	F	ZAGORAC MARIJA	11 Yrs Kumite Female 44+ kg	
	BIH005017	F	ZAGORAC MARIJA	10-11 Yrs Kata Team Female	

30th Balkan Karate Championships for Children 202 ..

ENTRIES BY NATIONAL FEDERATION

As of 31 MAY 2026

Code	ID	Gender	Name	Event	Seeding
BIH	BIH005424	F	ZAGRAN ANGELINA	12 Yrs Kumite Female -35 kg	
	BIH005110	F	ZEKOVIC AISA	11 Yrs Kumite Female 44+ kg	
	BIH005393	F	ZENUNOVIC ASJA	13 Yrs Kumite Female -44 kg	
	BIH004704	F	ZIGIC GLORIA	13 Yrs Kumite Female -44 kg	
	BIH005379	F	ZUKAN ADNA	10 Yrs Kumite Female 40+ kg	
BUL	BUL003144	M	ADVOKATOV IVAILO	13 Yrs Kata Individual Male	
	BUL003144	M	ADVOKATOV IVAILO	13 Yrs Kumite Male -50 kg	
	BUL003341	M	ANGELOV SIMEON	11 Yrs Kumite Male 50+ kg	
	BUL003536	M	ATANASOV DELYAN	13 Yrs Kumite Male -45 kg	
	BUL003532	M	ATANASOV KRISTIAN	10 Yrs Kata Individual Male	
	BUL003299	M	BABENOV HRISTOMIR	10 Yrs Kata Individual Male	
	BUL003516	M	BELCHEV BOZHIDAR	10 Yrs Kumite Male -35 kg	
	BUL003053	M	BLAGOEV BORISLAV	12 Yrs Kata Individual Male	
	BUL003053	M	BLAGOEV BORISLAV	12 Yrs Kumite Male -37 kg	
	BUL003326	M	BLAGOEV VASIL	12 Yrs Kata Individual Male	
	BUL003326	M	BLAGOEV VASIL	12 Yrs Kumite Male -52 kg	
	BUL003499	M	BOYADZHIEV STEFAN	10 Yrs Kumite Male -45 kg	
	BUL003327	M	DIMITROV EMILIYAN	9 Yrs Kata Individual Male	
	BUL003327	M	DIMITROV EMILIYAN	8-9 Yrs Kata Team Male	
	BUL003528	M	DIMITROV KONSTANTIN	11 Yrs Kumite Male -40 kg	
	BUL003503	M	DIMITROV KRISTOFAR	12 Yrs Kumite Male -52 kg	
	BUL003303	M	DIMITROV TODOR	13 Yrs Kumite Male -45 kg	
	BUL003531	M	DIMOVSKI STANISLAV	12 Yrs Kumite Male 52+ kg	
	BUL003324	M	DOLENSKI MARTIN	13 Yrs Kata Individual Male	
	BUL003324	M	DOLENSKI MARTIN	13 Yrs Kumite Male -55 kg	
	BUL003334	M	DRUMEV ISKREN	11 Yrs Kumite Male -35 kg	
	BUL003301	M	FARISSEV KAMEN	13 Yrs Kumite Male -45 kg	
	BUL003502	M	GEORGIEV GEORGI	10 Yrs Kumite Male -35 kg	
	BUL003329	M	GEORGIEV RADOSTIN	9 Yrs Kata Individual Male	
	BUL003329	M	GEORGIEV RADOSTIN	8-9 Yrs Kata Team Male	
	BUL003487	M	GEORGIEV SAMUIL	10 Yrs Kumite Male -30 kg	
	BUL003511	M	GEORGIEV YANISLAV	12 Yrs Kumite Male -37 kg	
	BUL003312	M	GOSPODINOV ALEKSANDAR	12 Yrs Kumite Male 52+ kg	
	BUL003479	M	HRISTOV NIKOLA	11 Yrs Kumite Male 50+ kg	
	BUL003101	M	IVANOV ADRIAN	13 Yrs Kumite Male 55+ kg	
	BUL003506	M	IVANOV ALEKSANDAR	12 Yrs Kata Individual Male	
	BUL003506	M	IVANOV ALEKSANDAR	12 Yrs Kumite Male -42 kg	
	BUL003057	M	IVANOV ALEKSANDAR	13 Yrs Kumite Male 55+ kg	
	BUL003320	M	IVANOV IVAN	11 Yrs Kata Individual Male	
	BUL003320	M	IVANOV IVAN	11 Yrs Kumite Male -35 kg	
	BUL003320	M	IVANOV IVAN	10-11 Yrs Kata Team Male	
	BUL003100	M	IVANOV NOVKO	13 Yrs Kumite Male -55 kg	
	BUL003345	M	IVANOV PETAR	10 Yrs Kata Individual Male	
	BUL003514	M	KALCHEV VALKO	13 Yrs Kumite Male -40 kg	
	BUL003497	M	KALFOV MARTIN	9 Yrs Kata Individual Male	
BUL003486	M	KIRILOV KRISTIAN	9 Yrs Kata Individual Male		
BUL003081	M	KOKONOV CVETOMIR	12 Yrs Kumite Male 52+ kg		

30th Balkan Karate Championships for Children 202 ..

ENTRIES BY NATIONAL FEDERATION

As of 31 MAY 2026

Code	ID	Gender	Name	Event	Seeding
BUL	BUL003500	M	KOPRINKOV LYUBOMIR	10 Yrs Kumite Male -40 kg	
	BUL003136	M	KOTEV ANTOAN	11 Yrs Kata Individual Male	
	BUL003136	M	KOTEV ANTOAN	11 Yrs Kumite Male -40 kg	
	BUL003136	M	KOTEV ANTOAN	10-11 Yrs Kata Team Male	
	BUL003333	M	MADZHIRSKI ALEXANDAR	13 Yrs Kumite Male -50 kg	
	BUL003095	M	MILANOV BORIS	11 Yrs Kata Individual Male	
	BUL003095	M	MILANOV BORIS	11 Yrs Kumite Male -35 kg	
	BUL003321	M	NACHEV VLADIMIR	10 Yrs Kata Individual Male	
	BUL003321	M	NACHEV VLADIMIR	10 Yrs Kumite Male -30 kg	
	BUL003321	M	NACHEV VLADIMIR	10-11 Yrs Kata Team Male	
	BUL003515	M	NIKOLOV NIKOLAY	9 Yrs Kata Individual Male	
	BUL003157	M	NIKOLOV STANISLAV	12 Yrs Kumite Male -52 kg	
	BUL003484	M	OVCHAROV ANDREY	8 Yrs Kata Individual Male	
	BUL003076	M	PAPANOV NIKOLA	12 Yrs Kumite Male -37 kg	
	BUL003133	M	PETKOV BOYAN	13 Yrs Kumite Male -50 kg	
	BUL003302	M	POPOV MIHAIL	13 Yrs Kumite Male -45 kg	
	BUL003498	M	RACHEV ALEKSANDAR	11 Yrs Kumite Male -40 kg	
	BUL003491	M	RAEV SAMUIL	10 Yrs Kumite Male 45+ kg	
	BUL003482	M	REBREISKI VESELIN	12 Yrs Kumite Male -47 kg	
	BUL003480	M	REMZI SINAN	10 Yrs Kumite Male 45+ kg	
	BUL003510	M	ROEV ALEKSANDAR	10 Yrs Kumite Male -35 kg	
	BUL003335	M	STANEV MITKO	11 Yrs Kumite Male -40 kg	
	BUL003330	M	STANOEV BORIL	10 Yrs Kata Individual Male	
	BUL003496	M	STEFANOV KRISTIYAN	8 Yrs Kata Individual Male	
	BUL003135	M	TESLARSKI BOJIDAR	11 Yrs Kata Individual Male	
	BUL003135	M	TESLARSKI BOJIDAR	11 Yrs Kumite Male -35 kg	
	BUL003135	M	TESLARSKI BOJIDAR	10-11 Yrs Kata Team Male	
	BUL003319	M	TOMOV GEORGY	11 Yrs Kata Individual Male	
	BUL003319	M	TOMOV GEORGY	11 Yrs Kumite Male -40 kg	
	BUL003319	M	TOMOV GEORGY	10-11 Yrs Kata Team Male	
	BUL003307	M	TSVYATKOV NIKOLAY	11 Yrs Kata Individual Male	
	BUL003307	M	TSVYATKOV NIKOLAY	11 Yrs Kumite Male -40 kg	
	BUL003134	M	VACHEV GEORGI	11 Yrs Kata Individual Male	
	BUL003134	M	VACHEV GEORGI	11 Yrs Kumite Male 50+ kg	
	BUL003134	M	VACHEV GEORGI	10-11 Yrs Kata Team Male	
	BUL003311	M	VANCHOV KALOYAN	12 Yrs Kumite Male -47 kg	
	BUL003328	M	VASILEV EMIL	9 Yrs Kata Individual Male	
	BUL003328	M	VASILEV EMIL	8-9 Yrs Kata Team Male	
	BUL003058	M	VASILEV MIROSLAV	13 Yrs Kumite Male 55+ kg	
	BUL003140	M	ZAHARIEV VELISLAV	12 Yrs Kata Individual Male	
	BUL003140	M	ZAHARIEV VELISLAV	12 Yrs Kumite Male -42 kg	
	BUL003318	M	ZLATKOV KRISTIYAN	11 Yrs Kumite Male -45 kg	
	BUL003495	F	ANGELOVA LORA	13 Yrs Kumite Female -54 kg	
	BUL003056	F	BALABANOVA DEYA	13 Yrs Kumite Female -44 kg	
	BUL003322	F	BONEVA BELOSLAVA	12 Yrs Kumite Female -40 kg	
	BUL003068	F	BORISOVA KAYA	13 Yrs Kumite Female -49 kg	
	BUL003343	F	BOYADZHIEVA BORISA	11 Yrs Kata Individual Female	
	BUL003343	F	BOYADZHIEVA BORISA	11 Yrs Kumite Female -40 kg	

30th Balkan Karate Championships for Children 202 ..

ENTRIES BY NATIONAL FEDERATION

As of 31 MAY 2026

Code	ID	Gender	Name	Event	Seeding
BUL	BUL003478	F	BOYADZHIEVA VIKTORIYA	11 Yrs Kumite Female 44+ kg	
	BUL003529	F	BULIEVA MIROSLAVA	11 Yrs Kumite Female 44+ kg	
	BUL003300	F	DGEVGET SIMGE	12 Yrs Kata Individual Female	
	BUL003300	F	DGEVGET SIMGE	12 Yrs Kumite Female 50+ kg	
	BUL003494	F	DIMITROVA DANAYA	8 Yrs Kata Individual Female	
	BUL003494	F	DIMITROVA DANAYA	8-9 Yrs Kata Team Female	
	BUL003091	F	DJAMIL SOFYIA	12 Yrs Kata Individual Female	
	BUL003091	F	DJAMIL SOFYIA	12 Yrs Kumite Female -50 kg	
	BUL003091	F	DJAMIL SOFYIA	12-13 Yrs Kata Team Female	
	BUL003325	F	DOLENSKA NIYA	13 Yrs Kata Individual Female	
	BUL003325	F	DOLENSKA NIYA	13 Yrs Kumite Female -54 kg	
	BUL003325	F	DOLENSKA NIYA	12-13 Yrs Kata Team Female	
	BUL003115	F	FIKRET ELIF	12 Yrs Kumite Female 50+ kg	
	BUL003524	F	FILIPOVA ZLATISLAVA	11 Yrs Kata Individual Female	
	BUL003524	F	FILIPOVA ZLATISLAVA	11 Yrs Kumite Female -40 kg	
	BUL003121	F	GEORGIEV ALEXANDRA	11 Yrs Kata Individual Female	
	BUL003121	F	GEORGIEV ALEXANDRA	11 Yrs Kumite Female -36 kg	
	BUL003121	F	GEORGIEV ALEXANDRA	10-11 Yrs Kata Team Female	
	BUL003099	F	GERASIMOVA MARIANA	12 Yrs Kumite Female -45 kg	
	BUL003492	F	GERGANOVA EMANOELA	13 Yrs Kumite Female -49 kg	
	BUL003523	F	GORANOVA KRISTINA	10 Yrs Kumite Female -37 kg	
	BUL003505	F	HRISTOVA YOANA	11 Yrs Kumite Female -32 kg	
	BUL003522	F	IGNATOVA VIKTORIA	9 Yrs Kata Individual Female	
	BUL003522	F	IGNATOVA VIKTORIA	8-9 Yrs Kata Team Female	
	BUL003509	F	IVANOVA ALEKSANDRA	10 Yrs Kumite Female -37 kg	
	BUL003513	F	IVANOVA DARINA	10 Yrs Kumite Female -30 kg	
	BUL003337	F	IVANOVA GABRIELA	9 Yrs Kata Individual Female	
	BUL003337	F	IVANOVA GABRIELA	8-9 Yrs Kata Team Female	
	BUL003504	F	IVANOVA ROSINA	11 Yrs Kumite Female -32 kg	
	BUL003316	F	IVANOVA YOANA	11 Yrs Kumite Female 44+ kg	
	BUL003517	F	KABAKCHIEVA DARINA	9 Yrs Kata Individual Female	
	BUL003534	F	KATELIEVA SOFIA	10 Yrs Kumite Female -30 kg	
	BUL003490	F	KIRILOVA VELIZARA	10 Yrs Kata Individual Female	
	BUL003490	F	KIRILOVA VELIZARA	10 Yrs Kumite Female -34 kg	
	BUL003066	F	KOSTOVA SIMONA	13 Yrs Kumite Female -54 kg	
	BUL003526	F	KRASTEVA TSVETELINA	12 Yrs Kumite Female -45 kg	
	BUL003508	F	KYURKCHIEVA KALINA	10 Yrs Kumite Female -30 kg	
	BUL003508	F	KYURKCHIEVA KALINA	10-11 Yrs Kata Team Female	
	BUL003106	F	MIHAILOVA MARGARITA	12 Yrs Kata Individual Female	
	BUL003106	F	MIHAILOVA MARGARITA	12 Yrs Kumite Female -45 kg	
	BUL003519	F	MILANOVA TSVETELINA	13 Yrs Kumite Female -54 kg	
	BUL003533	F	MONEVA SIMONA	13 Yrs Kata Individual Female	
	BUL003533	F	MONEVA SIMONA	13 Yrs Kumite Female -39 kg	
	BUL003489	F	MORALIYSKA KATRIN	10 Yrs Kata Individual Female	
	BUL003489	F	MORALIYSKA KATRIN	10 Yrs Kumite Female -30 kg	
	BUL003159	F	NIKIFOROVA TSVETELINA	12 Yrs Kumite Female -50 kg	
	BUL003530	F	NIKOLOVA EMA	11 Yrs Kumite Female -44 kg	
	BUL003483	F	NIKOLOVA IVAYLA	8 Yrs Kata Individual Female	

30th Balkan Karate Championships for Children 202 ..

ENTRIES BY NATIONAL FEDERATION

As of 31 MAY 2026

Code	ID	Gender	Name	Event	Seeding
BUL	BUL003483	F	NIKOLOVA IVAYLA	8-9 Yrs Kata Team Female	
	BUL003331	F	NIKOLOVA KRASINA	9 Yrs Kata Individual Female	
	BUL003308	F	PAVLOVA BOEVA RALITSA	12 Yrs Kumite Female -35 kg	
	BUL003485	F	PELTEKOVA VIKTORIA	8 Yrs Kata Individual Female	
	BUL003485	F	PELTEKOVA VIKTORIA	8-9 Yrs Kata Team Female	
	BUL003507	F	PENCHEVA VIKTORIYA	10 Yrs Kumite Female -34 kg	
	BUL003340	F	PETROVA ALEKSANDRA	10 Yrs Kata Individual Female	
	BUL003340	F	PETROVA ALEKSANDRA	10 Yrs Kumite Female -30 kg	
	BUL003112	F	POPOVA IRINA	13 Yrs Kata Individual Female	
	BUL003309	F	RADEVA VICTORIA	10 Yrs Kata Individual Female	
	BUL003309	F	RADEVA VICTORIA	10 Yrs Kumite Female -30 kg	
	BUL003309	F	RADEVA VICTORIA	10-11 Yrs Kata Team Female	
	BUL003139	F	RADOSLAVOVA NIKOL	12 Yrs Kata Individual Female	
	BUL003317	F	SIMEONOVA ALEKSANDRA	13 Yrs Kumite Female 54+ kg	
	BUL003527	F	SPASOVA KATERINA	11 Yrs Kumite Female -32 kg	
	BUL003315	F	STANCHEVA SOFIA	12 Yrs Kumite Female -35 kg	
	BUL003138	F	STEFANOVA KALINA	11 Yrs Kata Individual Female	
	BUL003138	F	STEFANOVA KALINA	11 Yrs Kumite Female -40 kg	
	BUL003138	F	STEFANOVA KALINA	10-11 Yrs Kata Team Female	
	BUL003150	F	STOYANOVA ADRIANA	11 Yrs Kumite Female -36 kg	
	BUL003150	F	STOYANOVA ADRIANA	10-11 Yrs Kata Team Female	
	BUL003512	F	TEKERLEKOVA LORA	13 Yrs Kumite Female -44 kg	
	BUL003063	F	TODOROVA VANESA	13 Yrs Kata Individual Female	
	BUL003063	F	TODOROVA VANESA	13 Yrs Kumite Female 54+ kg	
	BUL003481	F	TSONKOVA YANA	11 Yrs Kumite Female -32 kg	
	BUL003060	F	VASILEVA VANESA	13 Yrs Kumite Female -54 kg	
	BUL003344	F	VELKOVA NIKOL	11 Yrs Kumite Female -32 kg	
	BUL003339	F	VIHRIISKA BORISA	10 Yrs Kumite Female -30 kg	
	BUL003338	F	VOINOVA ELENA	9 Yrs Kata Individual Female	
	BUL003338	F	VOINOVA ELENA	8-9 Yrs Kata Team Female	
	BUL003323	F	YANKOVA ZORNITSA	13 Yrs Kata Individual Female	
	BUL003323	F	YANKOVA ZORNITSA	13 Yrs Kumite Female -49 kg	
	BUL003323	F	YANKOVA ZORNITSA	12-13 Yrs Kata Team Female	
	BUL003137	F	ZDRAVKOVA KRISTINA	11 Yrs Kata Individual Female	
	BUL003137	F	ZDRAVKOVA KRISTINA	11 Yrs Kumite Female -40 kg	
	BUL003137	F	ZDRAVKOVA KRISTINA	10-11 Yrs Kata Team Female	
CRO	CRO03991	M	BADURINA ADRIAN	13 Yrs Kumite Male 55+ kg	
	CRO004269	M	BARBARIC ANTE	12 Yrs Kumite Male -52 kg	
	CRO004268	M	BARBARIC MATE	12 Yrs Kumite Male -42 kg	
	CRO004542	M	BARSIC VITO	12 Yrs Kumite Male -37 kg	
	CRO004546	M	BAZINSKI DAVID	12 Yrs Kumite Male -47 kg	
	CRO004790	M	BILICIC TEO	11 Yrs Kumite Male -35 kg	
	CRO004530	M	BLAZEVIC IVAN	10 Yrs Kata Individual Male	
	CRO004548	M	BURNIC LEON	12 Yrs Kumite Male 52+ kg	
	CRO03959	M	BUTURAJAC MARK	13 Yrs Kumite Male -45 kg	
	CRO004514	M	CATIC VITO	11 Yrs Kumite Male -45 kg	
	CRO03430	M	CESAR JAN	13 Yrs Kata Individual Male	

30th Balkan Karate Championships for Children 202 ..

ENTRIES BY NATIONAL FEDERATION

As of 31 MAY 2026

Code	ID	Gender	Name	Event	Seeding
CRO	CRO004776	M	CESTAR FILIP	11 Yrs Kumite Male -45 kg	
	CRO004772	M	CRNKOVIC BORNA	11 Yrs Kumite Male -40 kg	
	CRO004267	M	CULJAK ADRIAN	12 Yrs Kumite Male -42 kg	
	CRO004786	M	DELIC TIN	10 Yrs Kumite Male -35 kg	
	CRO03927	M	DRAZIC IVAN	13 Yrs Kumite Male -40 kg	
	CRO03951	M	ERDESI PETAR	13 Yrs Kumite Male -50 kg	
	CRO004799	M	FILIPOVIC ANTE	11 Yrs Kumite Male -45 kg	
	CRO03904	M	HASANOVIC BORNA	13 Yrs Kumite Male -55 kg	
	CRO004787	M	HASANOVIC LOVRO	10 Yrs Kumite Male -30 kg	
	CRO004804	M	HEROLD TOM	11 Yrs Kumite Male -35 kg	
	CRO03928	M	HORVAT VID	13 Yrs Kumite Male 55+ kg	
	CRO004782	M	IVIC KRESIMIR	10 Yrs Kumite Male -35 kg	
	CRO004793	M	JURAGA DANI	11 Yrs Kumite Male -50 kg	
	CRO03899	M	KESEROVIC ALEN	13 Yrs Kumite Male -40 kg	
	CRO004598	M	KOKAN ADRIAN	13 Yrs Kata Individual Male	
	CRO004508	M	KOZIC PAVEL	11 Yrs Kumite Male -40 kg	
	CRO004809	M	LUKANOVIC TOMA	12 Yrs Kumite Male -37 kg	
	CRO004509	M	MARIC SIMUN	11 Yrs Kumite Male -35 kg	
	CRO03949	M	MESIC LUKA	13 Yrs Kumite Male 55+ kg	
	CRO004545	M	MRAKOVIC MATEJ	12 Yrs Kumite Male -42 kg	
	CRO03961	M	OZURA ANDREJ	13 Yrs Kumite Male -45 kg	
	CRO004784	M	PAJIC DONI	11 Yrs Kata Individual Male	
	CRO004791	M	PUKLAVEC MATKO	10 Yrs Kumite Male -35 kg	
	CRO03956	M	PUKLAVEC MISLAV	13 Yrs Kumite Male -40 kg	
	CRO004539	M	PUTRIC SIMUN	11 Yrs Kata Individual Male	
	CRO004293	M	RIBAR TOMA	12 Yrs Kumite Male -42 kg	
	CRO004778	M	SKARE IVAN	11 Yrs Kumite Male -40 kg	
	CRO004783	M	TOMLJANOVIC ERIK	10 Yrs Kumite Male -30 kg	
	CRO04040	M	TRTANJ ROKO	11 Yrs Kata Individual Male	
	CRO004544	M	ZALDANA LORENZO AARON	12 Yrs Kumite Male -37 kg	
	CRO004292	F	BAGARA LUCIJA	12 Yrs Kumite Female 50+ kg	
	CRO03924	F	BALOG TESA	13 Yrs Kumite Female 54+ kg	
	CRO004797	F	BASIC ZARA	11 Yrs Kumite Female -32 kg	
	CRO004781	F	BERISA DEA	13 Yrs Kumite Female 54+ kg	
	CRO004572	F	BEZINA NATALI	12 Yrs Kumite Female 50+ kg	
	CRO004518	F	BOLF PETRA	11 Yrs Kumite Female -40 kg	
	CRO004521	F	BRNADIC MARA	11 Yrs Kumite Female 44+ kg	
	CRO004792	F	BUTURAJAC KATJA	11 Yrs Kumite Female -36 kg	
	CRO03989	F	CAR GABRIELA	13 Yrs Kumite Female -54 kg	
	CRO004526	F	CEBIC TENA	9 Yrs Kata Individual Female	
	CRO004533	F	CEMOVIC MIA	10 Yrs Kata Individual Female	
	CRO004533	F	CEMOVIC MIA	10-11 Yrs Kata Team Female	
	CRO004777	F	CESTAR JANJA	8 Yrs Kata Individual Female	
	CRO004517	F	CRNCIC LANA	11 Yrs Kumite Female -36 kg	
	CRO004601	F	CRNOGORAC IVA	13 Yrs Kata Individual Female	
	CRO03950	F	CUK JOSIPA	13 Yrs Kumite Female -49 kg	
	CRO004788	F	CULIC FRANKA	11 Yrs Kumite Female -36 kg	
	CRO004290	F	DUNIC NIKA	12 Yrs Kumite Female -45 kg	

30th Balkan Karate Championships for Children 202 ..

ENTRIES BY NATIONAL FEDERATION

As of 31 MAY 2026

Code	ID	Gender	Name	Event	Seeding
CRO	CRO004581	F	ERAKOVIC TARA	13 Yrs Kumite Female -49 kg	
	CRO04060	F	FERCIC LUCIJA	13 Yrs Kumite Female 54+ kg	
	CRO004805	F	HEROLD ANA	10 Yrs Kumite Female 40+ kg	
	CRO004599	F	IBRAHIMPASIC MIA	13 Yrs Kata Individual Female	
	CRO03916	F	IVKOVIC EMA	13 Yrs Kata Individual Female	
	CRO004796	F	JERAT ELLA	12 Yrs Kumite Female -35 kg	
	CRO004519	F	JURACIC LARA	11 Yrs Kumite Female -40 kg	
	CRO004785	F	KOKAN KARLA	8 Yrs Kata Individual Female	
	CRO004583	F	KORDIC MARTA	13 Yrs Kumite Female -49 kg	
	CRO004563	F	KOSOVIC UMA	13 Yrs Kumite Female 54+ kg	
	CRO03954	F	KOSTADINOVA ALEKSANDRA	13 Yrs Kata Individual Female	
	CRO004801	F	KOVACIC LUCIA	10 Yrs Kumite Female -37 kg	
	CRO004775	F	KRULIC KATJA	12 Yrs Kumite Female -35 kg	
	CRO004552	F	KUKRIKA VANESSA	12 Yrs Kumite Female -40 kg	
	CRO004294	F	KURTI EVA	12 Yrs Kumite Female -40 kg	
	CRO03962	F	LENARD GABRIELA	13 Yrs Kumite Female -44 kg	
	CRO004561	F	LOVRIC ANA	12 Yrs Kumite Female -50 kg	
	CRO004794	F	LUKIN NELA	13 Yrs Kumite Female -54 kg	
	CRO004291	F	MARAZ DORIA	12 Yrs Kumite Female -45 kg	
	CRO03996	F	MARIC ANJA	13 Yrs Kumite Female -44 kg	
	CRO004789	F	MESIC LANA	10 Yrs Kumite Female -40 kg	
	CRO04005	F	MOHLER KATJA	13 Yrs Kumite Female -44 kg	
	CRO004773	F	MRAKOVIC ANA	12 Yrs Kumite Female -35 kg	
	CRO004795	F	MUDRONJA SARA	12 Yrs Kumite Female -50 kg	
	CRO004270	F	NOVAK LANA TINA	12 Yrs Kata Individual Female	
	CRO004800	F	NOVAK MARTA	10 Yrs Kata Individual Female	
	CRO004800	F	NOVAK MARTA	10 Yrs Kumite Female -34 kg	
	CRO004802	F	PANIC TONKA	10 Yrs Kumite Female -30 kg	
	CRO004584	F	PRANJIC VITA	12 Yrs Kumite Female -45 kg	
	CRO03963	F	PROSIC LAURA	13 Yrs Kumite Female -54 kg	
	CRO004593	F	SABLIJIC KLARA	12 Yrs Kata Individual Female	
	CRO03990	F	SAJATOVIC KARMEN	13 Yrs Kumite Female 54+ kg	
	CRO004275	F	SESTAK DALIA	12 Yrs Kumite Female 50+ kg	
	CRO004274	F	SGARDELLI LJATIFI ELLA	12 Yrs Kumite Female -40 kg	
	CRO004522	F	SKARON TIA	11 Yrs Kumite Female -40 kg	
	CRO004774	F	SOSTARIC KATJA	11 Yrs Kata Individual Female	
	CRO004774	F	SOSTARIC KATJA	10-11 Yrs Kata Team Female	
	CRO004297	F	STEFIC TONKA	13 Yrs Kata Individual Female	
	CRO004536	F	STEPANIC MARIJA	10 Yrs Kata Individual Female	
	CRO004536	F	STEPANIC MARIJA	10-11 Yrs Kata Team Female	
	CRO004562	F	TERZIC LEILA	13 Yrs Kumite Female -49 kg	
	CRO004798	F	TOMASIK NILA	11 Yrs Kumite Female -32 kg	
	CRO03987	F	VITA LOZO MILLA	13 Yrs Kumite Female -49 kg	
	CRO004803	F	VLADIC MILA	11 Yrs Kata Individual Female	
	CRO004266	F	VRBAN MASA	12 Yrs Kumite Female -40 kg	
	CRO004780	F	VUCIC ELENA	10 Yrs Kumite Female -30 kg	
	CRO004779	F	VUCIC KAJA	10 Yrs Kumite Female -34 kg	

30th Balkan Karate Championships for Children 202 ..

ENTRIES BY NATIONAL FEDERATION

As of 31 MAY 2026

Code	ID	Gender	Name	Event	Seeding
CYP	CYP003426	M	MARKOU ANTONIO	13 Yrs Kumite Male -45 kg	
	CYP003316	F	PETTEMERIDOU EKATERINI	13 Yrs Kumite Female -49 kg	
GRE	GRE004323	M	ALIMONAKIS IOANNIS	11 Yrs Kumite Male -35 kg	
	GRE004360	M	APOSTOLIADIS IASONAS	10 Yrs Kumite Male -30 kg	
	GRE004388	M	ATHANASOPOULOS GEORGIOS	12 Yrs Kata Individual Male	
	GRE004377	M	ATHANASOULOPOULOS MAXIMOS	9 Yrs Kata Individual Male	
	GRE02995	M	BAKOLAS IOANNIS	12 Yrs Kumite Male -47 kg	
	GRE003827	M	BARTSOKAS KONSTANTINOS	13 Yrs Kata Individual Male	
	GRE003827	M	BARTSOKAS KONSTANTINOS	13 Yrs Kumite Male -45 kg	
	GRE004370	M	BOULIARIS PARASKEVAS	11 Yrs Kumite Male -40 kg	
	GRE003816	M	CHARALAMPAKIS IASONAS	13 Yrs Kumite Male -45 kg	
	GRE003775	M	CHAROS ARGYRIOS	13 Yrs Kumite Male -45 kg	
	GRE004103	M	CHRYSAFIS SAMOUIL ALEXANDROS	11 Yrs Kumite Male -35 kg	
	GRE004384	M	DAFNIS SPYRIDON	12 Yrs Kumite Male -37 kg	
	GRE004125	M	DIMOPOULOS DIMITRIOS	11 Yrs Kata Individual Male	
	GRE004125	M	DIMOPOULOS DIMITRIOS	11 Yrs Kumite Male -40 kg	
	GRE004337	M	DRAKOULAKIS MENELAOS	11 Yrs Kumite Male 50+ kg	
	GRE004394	M	DRAMILARAKIS ANGELOS	13 Yrs Kumite Male 55+ kg	
	GRE003768	M	GALANIS KONSTANTINOS	13 Yrs Kumite Male -45 kg	
	GRE004077	M	GAVALAS GRIGORIOS	13 Yrs Kumite Male -40 kg	
	GRE004312	M	GEORGOGIANNIS IOANNIS	13 Yrs Kumite Male -55 kg	
	GRE004371	M	GKANAS ANGELOS	10 Yrs Kumite Male -35 kg	
	GRE003806	M	GKIONAKIS IOANNIS	13 Yrs Kumite Male -50 kg	
	GRE004366	M	GKIONIS EVANGELOS	10 Yrs Kumite Male -45 kg	
	GRE003838	M	GRAMMATIKOS CHRISTOS GIANNOS	12 Yrs Kata Individual Male	
	GRE003838	M	GRAMMATIKOS CHRISTOS GIANNOS	12 Yrs Kumite Male -37 kg	
	GRE004342	M	GRAVALOS EFTHYMIOS	10 Yrs Kumite Male -35 kg	
	GRE003819	M	GRIGORIOU MARIOS	13 Yrs Kumite Male -55 kg	
	GRE004338	M	GRIVAKIS GEORGIOS	10 Yrs Kumite Male -45 kg	
	GRE003833	M	IOSIFIDIS EKTORAS	13 Yrs Kata Individual Male	
	GRE003833	M	IOSIFIDIS EKTORAS	13 Yrs Kumite Male -55 kg	
	GRE003842	M	KAFARATZIS CHRISTOS	12 Yrs Kumite Male -42 kg	
	GRE004106	M	KAPASAKALIDIS DIMITRIOS	11 Yrs Kumite Male -35 kg	
	GRE004081	M	KARAGIANNIS PANAGIOTIS KONSTANTINOS	11 Yrs Kumite Male -45 kg	
	GRE004361	M	KARAKONTIS MICHAIL ANGELOS	13 Yrs Kumite Male -45 kg	
	GRE004352	M	KARAMICHALIS PANAGIOTIS	12 Yrs Kumite Male 52+ kg	
	GRE004111	M	KAROUNIS KONSTANTINOS	11 Yrs Kumite Male -40 kg	
	GRE004385	M	KATOMERIS THEODOROS	11 Yrs Kumite Male -45 kg	
GRE004112	M	KATSIKIS PANAGIOTIS	12 Yrs Kumite Male -42 kg		
GRE004362	M	KATSOUNIS ALEXANDROS	8 Yrs Kata Individual Male		
GRE004113	M	KATSOUNIS VASILEIOS	11 Yrs Kumite Male -35 kg		
GRE004392	M	KAZANTZAKIS KONSTANTINOS	11 Yrs Kumite Male -45 kg		
GRE003825	M	KONSTANTOPOULOS ATHANASIOS	12 Yrs Kumite Male 52+ kg		
GRE004397	M	KORDOS LEONIDAS	13 Yrs Kumite Male -40 kg		
GRE004367	M	KOUROUPIS DIMOS	10 Yrs Kumite Male -30 kg		

30th Balkan Karate Championships for Children 202 ..

ENTRIES BY NATIONAL FEDERATION

As of 31 MAY 2026

Code	ID	Gender	Name	Event	Seeding
GRE	GRE004116	M	LERANTZIS ATHANASIOS	11 Yrs Kumite Male -40 kg	
	GRE004180	M	MAKRIS PANAGIOTIS	11 Yrs Kumite Male -35 kg	
	GRE004317	M	METAXAS FILIPPOS	13 Yrs Kumite Male 55+ kg	
	GRE004109	M	MINOUDIS ION	13 Yrs Kumite Male -45 kg	
	GRE003760	M	MOURATIDIS IOANNIS	13 Yrs Kata Individual Male	
	GRE003760	M	MOURATIDIS IOANNIS	13 Yrs Kumite Male -40 kg	
	GRE03049	M	NIKIFOROS MICHAIL	12 Yrs Kata Individual Male	
	GRE03049	M	NIKIFOROS MICHAIL	12 Yrs Kumite Male -37 kg	
	GRE004087	M	NIKIFOROS PANAGIOTIS	9 Yrs Kata Individual Male	
	GRE004389	M	NIKOLAIDIS VASILEIOS ANGELOS	12 Yrs Kumite Male -52 kg	
	GRE004347	M	NTALAMPIRAS EVANGELOS	9 Yrs Kata Individual Male	
	GRE004348	M	NTIKOS KONSTANTINOS	13 Yrs Kata Individual Male	
	GRE004322	M	PANAGAKOS PARIS	13 Yrs Kumite Male -55 kg	
	GRE004065	M	PAPAGIANNIS NIKITAS	9 Yrs Kata Individual Male	
	GRE004100	M	PAPATHEODOROU ATHANASIOS	11 Yrs Kumite Male -50 kg	
	GRE004365	M	PAPAZIS EMMANOUIL	10 Yrs Kata Individual Male	
	GRE004365	M	PAPAZIS EMMANOUIL	10 Yrs Kumite Male -40 kg	
	GRE004364	M	PAPPAS NIKOLAOS	13 Yrs Kumite Male -55 kg	
	GRE004349	M	PARASKEVAS MARIOS	10 Yrs Kata Individual Male	
	GRE004349	M	PARASKEVAS MARIOS	10 Yrs Kumite Male -40 kg	
	GRE003817	M	PATSARINOS ANTONIOS	12 Yrs Kata Individual Male	
	GRE003817	M	PATSARINOS ANTONIOS	12 Yrs Kumite Male -42 kg	
	GRE004128	M	PATSARINOS GEORGIOS	9 Yrs Kata Individual Male	
	GRE004101	M	PRIMIKYRIOS DIMITRIOS	11 Yrs Kumite Male -40 kg	
	GRE004381	M	SIAFLAS CHRISTOS	11 Yrs Kumite Male -40 kg	
	GRE004325	M	SKAFAS FILIPPOS	10 Yrs Kumite Male -40 kg	
	GRE004386	M	SKAPETORRACHIS ORFEAS	10 Yrs Kumite Male -35 kg	
	GRE004357	M	SKEVIS FILIPPOS	8 Yrs Kata Individual Male	
	GRE004330	M	SKOURMPOUTIS DAMIANOS	11 Yrs Kumite Male -45 kg	
	GRE004382	M	SOUEREF ALEXIOS IOSIF	12 Yrs Kumite Male 52+ kg	
	GRE003770	M	SPATHOULAS GEORGIOS	12 Yrs Kumite Male -42 kg	
	GRE004359	M	STAMOULOS ORFEAS IOANNIS	8 Yrs Kata Individual Male	
	GRE004068	M	STAMPOLIS ANDREAS	11 Yrs Kumite Male -35 kg	
	GRE003767	M	STERTSOS VASILEIOS	10 Yrs Kata Individual Male	
	GRE003767	M	STERTSOS VASILEIOS	10 Yrs Kumite Male -40 kg	
	GRE004310	M	THERIANOS FILIPPOS	12 Yrs Kumite Male 52+ kg	
	GRE003831	M	TRIAANTAFYLLIS IASON	12 Yrs Kumite Male -37 kg	
	GRE004340	M	TSALAPATARAS IOANNIS DIMITRIOS	12 Yrs Kumite Male -37 kg	
	GRE004383	M	TSIGRIMAS GEORGIOS APOLLONAS	9 Yrs Kata Individual Male	
	GRE03506	M	TSIMPOS IOANNIS	13 Yrs Kumite Male 55+ kg	
	GRE003769	M	VAMVAKOS ALEXANDROS	13 Yrs Kumite Male -45 kg	
	GRE03090	M	VOURIS DIMITRIOS	12 Yrs Kata Individual Male	
	GRE03090	M	VOURIS DIMITRIOS	12 Yrs Kumite Male -42 kg	
	GRE004075	M	ZACHARIOUDAKIS IOANNIS	13 Yrs Kata Individual Male	
	GRE003798	M	ZEFI DED	12 Yrs Kumite Male -52 kg	
	GRE004380	M	ZERVAKIS IOANNIS	11 Yrs Kumite Male -35 kg	
	GRE004122	F	AGATHOU MARIA ANGELIKI	13 Yrs Kata Individual Female	
	GRE004122	F	AGATHOU MARIA ANGELIKI	13 Yrs Kumite Female -39 kg	

30th Balkan Karate Championships for Children 202 ..

ENTRIES BY NATIONAL FEDERATION

As of 31 MAY 2026

Code	ID	Gender	Name	Event	Seeding
GRE	GRE004335	F	ALEXIOU NEFELI	10 Yrs Kumite Female -30 kg	
	GRE004069	F	ALEXOUDI ANDRIANI SOFIA	11 Yrs Kata Individual Female	
	GRE004378	F	ANDRIANESI STAMATIA	13 Yrs Kata Individual Female	
	GRE004345	F	BIRMPAKOU ELENA	10 Yrs Kata Individual Female	
	GRE004345	F	BIRMPAKOU ELENA	10 Yrs Kumite Female -34 kg	
	GRE003758	F	BIRMPAKOU EVGENIA	12 Yrs Kumite Female -40 kg	
	GRE004130	F	BROUZAKI MARIA	11 Yrs Kumite Female -36 kg	
	GRE004133	F	CHARALAMPAKI GARYFALLIA ARIADNI	11 Yrs Kumite Female -36 kg	
	GRE004373	F	CHAROU KALLIOPI	10 Yrs Kumite Female -30 kg	
	GRE004331	F	DIAMANTOPOULOU ILEKTRA	9 Yrs Kata Individual Female	
	GRE004126	F	DIONYSOPOULOU ARCHONTIA	12 Yrs Kata Individual Female	
	GRE004126	F	DIONYSOPOULOU ARCHONTIA	12 Yrs Kumite Female -35 kg	
	GRE004396	F	ELEFTHERIOU NIOVI EVANGELIA	10 Yrs Kumite Female -30 kg	
	GRE004093	F	FLOROU FOTEINI	13 Yrs Kumite Female -44 kg	
	GRE004324	F	GALANI MARIA ALEKSANDRA	10 Yrs Kumite Female -34 kg	
	GRE004135	F	GEROKONSTANTI MYRTO PANAGIOTA	12 Yrs Kumite Female -45 kg	
	GRE004351	F	GLENTI DIMITRA	8 Yrs Kata Individual Female	
	GRE004351	F	GLENTI DIMITRA	8-9 Yrs Kata Team Female	
	GRE004131	F	GRAVALOU MYRTO EIRINI	13 Yrs Kumite Female -44 kg	
	GRE003801	F	IOANNIDI IOANNA	13 Yrs Kumite Female 54+ kg	
	GRE004372	F	KAKLAMANOOU KONSTANTINA	10 Yrs Kumite Female -30 kg	
	GRE004399	F	KARACHALIOU PANAGIOTA	11 Yrs Kumite Female -44 kg	
	GRE004172	F	KARELLI EVA	13 Yrs Kumite Female -39 kg	
	GRE004339	F	KATSARI PANAGIOTA FANOURIA	11 Yrs Kumite Female 44+ kg	
	GRE004374	F	KESIDOU ZOI	13 Yrs Kumite Female -54 kg	
	GRE004401	F	KOLIOU MARIA	8 Yrs Kata Individual Female	
	GRE004332	F	KONSTANTELLOU MARIA	10 Yrs Kumite Female 40+ kg	
	GRE004071	F	KOTSIKONA ATHANASIA MARIA	12 Yrs Kumite Female 50+ kg	
	GRE004091	F	KOUFOGEOGOU AIKATERINI	12 Yrs Kumite Female -40 kg	
	GRE004063	F	KOUGIOUMTZOGLOU LITO	11 Yrs Kumite Female -44 kg	
	GRE004398	F	KOUMPOULI SPYRIDOULA	10 Yrs Kumite Female -37 kg	
	GRE004375	F	KYRIAKOPOULOU AMALIA	11 Yrs Kumite Female -40 kg	
	GRE003797	F	LAMPRAKI PANAGIOTA	10 Yrs Kata Individual Female	
	GRE003797	F	LAMPRAKI PANAGIOTA	10 Yrs Kumite Female -34 kg	
	GRE003797	F	LAMPRAKI PANAGIOTA	10-11 Yrs Kata Team Female	
	GRE004368	F	LENI AIKATERINI MARIA	13 Yrs Kumite Female -54 kg	
	GRE004363	F	MAKRI DESPOINA	10 Yrs Kumite Female -37 kg	
	GRE004387	F	MAKRYPODI VASILIKI LYDIA	13 Yrs Kumite Female -44 kg	
	GRE003755	F	MALAMATINI EVANTHIA	13 Yrs Kumite Female 54+ kg	
	GRE004333	F	MARINAKI MARIANNA	10 Yrs Kata Individual Female	
	GRE003844	F	MATSANGOU ANTONIA	13 Yrs Kumite Female -44 kg	
	GRE004343	F	MEIMARIDOU EVDOKIA	13 Yrs Kumite Female -49 kg	
	GRE003824	F	MELI FAIDRA	13 Yrs Kata Individual Female	
	GRE003824	F	MELI FAIDRA	13 Yrs Kumite Female -39 kg	
	GRE003835	F	MITAKIDI DANAI	13 Yrs Kata Individual Female	
	GRE003835	F	MITAKIDI DANAI	13 Yrs Kumite Female -39 kg	

30th Balkan Karate Championships for Children 202 ..

ENTRIES BY NATIONAL FEDERATION

As of 31 MAY 2026

Code	ID	Gender	Name	Event	Seeding
GRE	GRE004344	F	MOSCHOU KLEIO	12 Yrs Kumite Female 50+ kg	
	GRE004327	F	MPITROU ISIDORA	12 Yrs Kumite Female -40 kg	
	GRE004402	F	NEZERITI IOANNA	11 Yrs Kata Individual Female	
	GRE004346	F	NISIOTI ANASTASIA	10 Yrs Kata Individual Female	
	GRE004346	F	NISIOTI ANASTASIA	10 Yrs Kumite Female -37 kg	
	GRE004390	F	ORFANOU EVANGELIA	11 Yrs Kata Individual Female	
	GRE004179	F	PANAGEA STAVROULA	11 Yrs Kata Individual Female	
	GRE004179	F	PANAGEA STAVROULA	11 Yrs Kumite Female -40 kg	
	GRE03056	F	PANAGIOTOPOULOU THALEIA	12 Yrs Kata Individual Female	
	GRE03056	F	PANAGIOTOPOULOU THALEIA	12 Yrs Kumite Female -45 kg	
	GRE03512	F	PAPACHRISTOU EVGENIA	11 Yrs Kata Individual Female	
	GRE03512	F	PAPACHRISTOU EVGENIA	11 Yrs Kumite Female -36 kg	
	GRE03512	F	PAPACHRISTOU EVGENIA	10-11 Yrs Kata Team Female	
	GRE004395	F	PAPADIMA SOFIA	8 Yrs Kata Individual Female	
	GRE03528	F	PAPADOPOULOU SOFIA	13 Yrs Kata Individual Female	
	GRE03528	F	PAPADOPOULOU SOFIA	13 Yrs Kumite Female -49 kg	
	GRE004089	F	PAPAMICHAIL DIMITRA MARGARITA	13 Yrs Kumite Female -49 kg	
	GRE004066	F	PILATOU DIMITRA	11 Yrs Kata Individual Female	
	GRE004066	F	PILATOU DIMITRA	11 Yrs Kumite Female -36 kg	
	GRE004066	F	PILATOU DIMITRA	10-11 Yrs Kata Team Female	
	GRE004353	F	POLYKANDRIOTI DIMITRA	8 Yrs Kata Individual Female	
	GRE004353	F	POLYKANDRIOTI DIMITRA	8-9 Yrs Kata Team Female	
	GRE004329	F	POLYMENAKOU ALEXIA	10 Yrs Kumite Female 40+ kg	
	GRE004354	F	POTSI NATALIA	8 Yrs Kata Individual Female	
	GRE004354	F	POTSI NATALIA	8-9 Yrs Kata Team Female	
	GRE004334	F	PRIFTI ANNA MARIA	9 Yrs Kata Individual Female	
	GRE004097	F	SALAMPASIDI NEFELI	11 Yrs Kumite Female -36 kg	
	GRE004356	F	SKEVI ALEXANDRA	9 Yrs Kata Individual Female	
	GRE004355	F	SKEVI ELEFThERIA	13 Yrs Kumite Female -39 kg	
	GRE004358	F	SOFIANIDOU DIMITRA	8 Yrs Kata Individual Female	
	GRE03527	F	SOURA IOANNA	13 Yrs Kata Individual Female	
	GRE03527	F	SOURA IOANNA	13 Yrs Kumite Female 54+ kg	
	GRE03527	F	SOURA IOANNA	12-13 Yrs Kata Team Female	
	GRE004391	F	SPANAKI KALLIOPI	12 Yrs Kata Individual Female	
	GRE03502	F	SPANOU IOANNA	13 Yrs Kumite Female -44 kg	
	GRE03499	F	STAMATAKI LYDIA	13 Yrs Kumite Female -39 kg	
	GRE004067	F	STAMPOLI KONSTANTINA	12 Yrs Kumite Female -35 kg	
	GRE004328	F	STATHI IOANNA	12 Yrs Kumite Female -35 kg	
	GRE004090	F	STEFANITSI ZOI	12 Yrs Kumite Female -40 kg	
	GRE003780	F	THALASSINOY PARASKEVI	12 Yrs Kumite Female -45 kg	
	GRE003781	F	THEOCHARI IOANNA CHRYSOVALANTI	13 Yrs Kumite Female -44 kg	
	GRE003781	F	THEOCHARI IOANNA CHRYSOVALANTI	12-13 Yrs Kata Team Female	
	GRE003782	F	THEOCHARI PANAGIOTA	13 Yrs Kata Individual Female	
	GRE003782	F	THEOCHARI PANAGIOTA	13 Yrs Kumite Female -39 kg	
	GRE003782	F	THEOCHARI PANAGIOTA	12-13 Yrs Kata Team Female	
	GRE004393	F	TSAMAKLI THEODORA	12 Yrs Kumite Female -50 kg	

30th Balkan Karate Championships for Children 202 ..

ENTRIES BY NATIONAL FEDERATION

As of 31 MAY 2026

Code	ID	Gender	Name	Event	Seeding
GRE	GRE004400	F	TSAPOGA NEFELI	12 Yrs Kumite Female -45 kg	
	GRE004086	F	TSIOTA LYDIA	12 Yrs Kumite Female -50 kg	
	GRE004376	F	TSIOTA MELINA	10 Yrs Kumite Female 40+ kg	
	GRE004350	F	TSOKOU ARIADNI	12 Yrs Kumite Female -45 kg	
	GRE004341	F	TSOTZOLA AGAPI	11 Yrs Kumite Female -40 kg	
	GRE003774	F	TSOUREA PINELOPI	12 Yrs Kumite Female -45 kg	
	GRE004073	F	TZEDAKI MARIA	11 Yrs Kata Individual Female	
	GRE004061	F	VASILEIOU ELENI	9 Yrs Kata Individual Female	
	GRE004061	F	VASILEIOU ELENI	8-9 Yrs Kata Team Female	
	GRE004098	F	VASTARDI AMALIA	12 Yrs Kumite Female -40 kg	
	GRE004336	F	VELENTZA MARIA IOANNA	11 Yrs Kumite Female 44+ kg	
	GRE004088	F	VOUTSINA IOULIA IOANNA	13 Yrs Kumite Female -49 kg	
	GRE003751	F	VRAILA ANGELIKI	12 Yrs Kumite Female -35 kg	
	GRE004074	F	ZACHARIOUDAKI MARIA	12 Yrs Kata Individual Female	
	GRE004326	F	ZARKADOYLA FOTINI	13 Yrs Kumite Female -44 kg	
	GRE004369	F	ZENEMPISI ELENI	10 Yrs Kumite Female -40 kg	
	GRE004102	F	ZIOGOU AIKATERINI	11 Yrs Kumite Female 44+ kg	
KOS	KOS003677	M	ADEMI LORIK	11 Yrs Kumite Male -40 kg	
	KOS003673	M	BUJUPI ALPI	9 Yrs Kata Individual Male	
	KOS003815	M	BUSHI METIN	13 Yrs Kumite Male 55+ kg	
	KOS003682	M	HASAJ OLTİ	13 Yrs Kata Individual Male	
	KOS003682	M	HASAJ OLTİ	13 Yrs Kumite Male -45 kg	
	KOS02923	M	HYSENI OMER	12 Yrs Kata Individual Male	
	KOS02923	M	HYSENI OMER	12 Yrs Kumite Male -37 kg	
	KOS003823	M	İSTREFİ BAKI	13 Yrs Kumite Male -40 kg	
	KOS003525	M	MAKOLLI ERİN	12 Yrs Kumite Male 52+ kg	
	KOS003545	M	MANI RIAD	13 Yrs Kumite Male 55+ kg	
	KOS003686	M	MJEKIQI YLLI	13 Yrs Kumite Male -55 kg	
	KOS003687	M	MURATI GENT	11 Yrs Kumite Male 50+ kg	
	KOS003825	M	MUSA MATIN	12 Yrs Kumite Male -52 kg	
	KOS003595	M	NAMANI HARIS	13 Yrs Kumite Male -50 kg	
	KOS003811	M	PACOLLI DIJAR	13 Yrs Kumite Male 55+ kg	
	KOS03309	M	PEPAJ ERGIS	13 Yrs Kumite Male -55 kg	
	KOS003679	M	RECICA ANUAR	11 Yrs Kumite Male -45 kg	
	KOS003822	M	SADIKU LEART	13 Yrs Kumite Male 55+ kg	
	KOS003824	M	SHALA ANDIN	12 Yrs Kumite Male -52 kg	
	KOS003547	M	SHALA İSA	13 Yrs Kumite Male -50 kg	
	KOS003555	M	SHALA PRINC	10 Yrs Kumite Male -35 kg	
	KOS03319	M	SHALQINI FRON	13 Yrs Kumite Male -50 kg	
	KOS003810	M	VELIU NOAR	10 Yrs Kumite Male -45 kg	
	KOS003827	M	ZEQRİAJ AJAN	9 Yrs Kata Individual Male	
	KOS003546	M	ZEQRİAJ RRON	12 Yrs Kumite Male -47 kg	
	KOS03311	F	ALUSHAJ ARTESA	13 Yrs Kumite Female -39 kg	
	KOS003809	F	BARUTI ERTA	12 Yrs Kumite Female 50+ kg	
	KOS003817	F	BEQIRI KIARA	9 Yrs Kata Individual Female	
KOS003804	F	DAUTI ONIDA	13 Yrs Kumite Female -54 kg		
KOS003550	F	DEMAJ AMRA	13 Yrs Kumite Female 54+ kg		

30th Balkan Karate Championships for Children 202 ..

ENTRIES BY NATIONAL FEDERATION

As of 31 MAY 2026

Code	ID	Gender	Name	Event	Seeding
KOS	KOS003813	F	DERNJANI ALBESA	12 Yrs Kumite Female -40 kg	
	KOS003821	F	FAZLIU HIRA	13 Yrs Kumite Female -39 kg	
	KOS003681	F	GASHI MARTINA	11 Yrs Kumite Female -32 kg	
	KOS03359	F	HALIMI SUMEJA	13 Yrs Kumite Female -44 kg	
	KOS003816	F	KALISI ERLISA	12 Yrs Kumite Female -35 kg	
	KOS003814	F	KORAQI SALA	12 Yrs Kumite Female -35 kg	
	KOS003533	F	KRASNIQI ARITA	12 Yrs Kumite Female -45 kg	
	KOS03326	F	MAKOLLI NATRA	13 Yrs Kumite Female -54 kg	
	KOS003818	F	MIFTARI ALNISA	11 Yrs Kata Individual Female	
	KOS003818	F	MIFTARI ALNISA	11 Yrs Kumite Female -36 kg	
	KOS003819	F	MUSA BORA	12 Yrs Kumite Female -45 kg	
	KOS003830	F	MUSLIU REINA	12 Yrs Kumite Female -50 kg	
	KOS003676	F	ORLLATI LORA	11 Yrs Kumite Female -40 kg	
	KOS003534	F	PRENAJ ADRIANA	12 Yrs Kumite Female -50 kg	
	KOS003688	F	RAMA AMELIA	11 Yrs Kumite Female -40 kg	
	KOS003526	F	RAMA REINA	13 Yrs Kumite Female -39 kg	
	KOS003829	F	STATOVCI AULONA	12 Yrs Kumite Female -50 kg	
	KOS003812	F	VILA RONA	12 Yrs Kumite Female -40 kg	
	KOS003820	F	ZOGAJ ERISA	10 Yrs Kumite Female -30 kg	
	MNE	MNE004040	M	AGOVIC DILAN	12 Yrs Kata Individual Male
MNE004040		M	AGOVIC DILAN	12 Yrs Kumite Male -52 kg	
MNE003756		M	BAKIC ANTO	13 Yrs Kumite Male 55+ kg	
MNE03113		M	BARJAKTAROVIC ANDRIJA	13 Yrs Kata Individual Male	
MNE03113		M	BARJAKTAROVIC ANDRIJA	12-13 Yrs Kata Team Male	
MNE003583		M	BARJAKTAROVIC MATIJA	12 Yrs Kumite Male -37 kg	
MNE003834		M	BJELANOVIC ALEKSA	11 Yrs Kumite Male -45 kg	
MNE004087		M	BOCI ARBER	12 Yrs Kumite Male -47 kg	
MNE004051		M	BUBANJA BORIS	10 Yrs Kumite Male -30 kg	
MNE03298		M	BULATOVIC FILIP	11 Yrs Kata Individual Male	
MNE004075		M	CIROVIC TEODOR	10 Yrs Kumite Male -30 kg	
MNE02840		M	CUPARA JAKOV	13 Yrs Kata Individual Male	
MNE02840		M	CUPARA JAKOV	13 Yrs Kumite Male -55 kg	
MNE02840		M	CUPARA JAKOV	12-13 Yrs Kata Team Male	
MNE004041		M	DJUKANOVIC LUKA	13 Yrs Kumite Male 55+ kg	
MNE003739		M	DRACA IVAN	11 Yrs Kata Individual Male	
MNE003739		M	DRACA IVAN	10-11 Yrs Kata Team Male	
MNE03289		M	DROBNJAK LUKA	11 Yrs Kata Individual Male	
MNE03289		M	DROBNJAK LUKA	11 Yrs Kumite Male -40 kg	
MNE03289		M	DROBNJAK LUKA	10-11 Yrs Kata Team Male	
MNE004076		M	DUMIC MARKO	10 Yrs Kumite Male -30 kg	
MNE004088		M	GRBAVAC NIKOLA	12 Yrs Kumite Male -47 kg	
MNE003742		M	GUSINJAC IMRAN	13 Yrs Kata Individual Male	
MNE004043		M	HADZAJLIC DZENAN	8 Yrs Kata Individual Male	
MNE004042		M	HAJCMAN STEFAN	12 Yrs Kumite Male 52+ kg	
MNE004069		M	HALILOVIC DZAN	9 Yrs Kata Individual Male	
MNE003591		M	ILINCIC ALEKSEJ	12 Yrs Kumite Male -47 kg	
MNE004057	M	ILINCIC LUKA	10 Yrs Kumite Male 45+ kg		

30th Balkan Karate Championships for Children 202 ..

ENTRIES BY NATIONAL FEDERATION

As of 31 MAY 2026

Code	ID	Gender	Name	Event	Seeding
MNE	MNE004057	M	ILINCIC LUKA	10-11 Yrs Kata Team Male	
	MNE03284	M	ILINCIC LUKA	11 Yrs Kata Individual Male	
	MNE03372	M	IVANISEVIC VUJO	13 Yrs Kumite Male -45 kg	
	MNE02992	M	JANKOVIC MILOVAN	12 Yrs Kumite Male -47 kg	
	MNE004047	M	KASALICA NIKOLA	8 Yrs Kata Individual Male	
	MNE004047	M	KASALICA NIKOLA	8-9 Yrs Kata Team Male	
	MNE003585	M	KASCELAN PAVLE	12 Yrs Kumite Male -37 kg	
	MNE003575	M	KATIC BOGOSLAV	13 Yrs Kumite Male -40 kg	
	MNE003831	M	KATIC LAZAR	11 Yrs Kumite Male -40 kg	
	MNE004055	M	KNEZEVIC VOJIN	10 Yrs Kumite Male -40 kg	
	MNE03302	M	KOVACEVIC STEFAN	12 Yrs Kumite Male -37 kg	
	MNE003618	M	KRSTAJIC ALEKSA	12 Yrs Kata Individual Male	
	MNE003896	M	KRSTAJIC DANILO	9 Yrs Kata Individual Male	
	MNE003896	M	KRSTAJIC DANILO	8-9 Yrs Kata Team Male	
	MNE003843	M	LAZIC PAVLE	11 Yrs Kumite Male -50 kg	
	MNE003593	M	LAZOVIC PAVLE	12 Yrs Kumite Male 52+ kg	
	MNE03291	M	LEKOVIC BALSA	12 Yrs Kata Individual Male	
	MNE03291	M	LEKOVIC BALSA	12-13 Yrs Kata Team Male	
	MNE004054	M	LISICIC MIHAILO	10 Yrs Kumite Male -35 kg	
	MNE03304	M	MARAS MATIJA	11 Yrs Kata Individual Male	
	MNE003815	M	MARINOVIC JAKSA	12 Yrs Kumite Male -47 kg	
	MNE004048	M	MARKOVIC OGNJEN	8 Yrs Kata Individual Male	
	MNE004048	M	MARKOVIC OGNJEN	8-9 Yrs Kata Team Male	
	MNE003829	M	MAZALICA NIKOLA	11 Yrs Kumite Male -40 kg	
	MNE004074	M	MICETA FILIP	10 Yrs Kumite Male -30 kg	
	MNE004070	M	MIJOVIC PAVLE	9 Yrs Kata Individual Male	
	MNE004070	M	MIJOVIC PAVLE	8-9 Yrs Kata Team Male	
	MNE003584	M	MIKULIC PETAR	12 Yrs Kumite Male -37 kg	
	MNE004045	M	MILACIC LAZAR	8 Yrs Kata Individual Male	
	MNE003616	M	MILOSEVIC MATIJA	13 Yrs Kata Individual Male	
	MNE003616	M	MILOSEVIC MATIJA	12-13 Yrs Kata Team Male	
	MNE004046	M	MINEVSKI LAV	8 Yrs Kata Individual Male	
	MNE03306	M	MIRKOVIC UROS	11 Yrs Kata Individual Male	
	MNE003592	M	NIKAC NIKOLA	12 Yrs Kumite Male 52+ kg	
	MNE003589	M	NIKOLIC ANDRIJA	12 Yrs Kumite Male -42 kg	
	MNE003740	M	OPACINA ANDRIJA	11 Yrs Kata Individual Male	
	MNE003740	M	OPACINA ANDRIJA	10-11 Yrs Kata Team Male	
	MNE004053	M	OSTOJIC VASILIJE	10 Yrs Kumite Male -35 kg	
	MNE003892	M	PAJOVIC MAKSIM	9 Yrs Kata Individual Male	
	MNE003892	M	PAJOVIC MAKSIM	8-9 Yrs Kata Team Male	
	MNE004090	M	PEJOVIC OGNJEN	12 Yrs Kumite Male -42 kg	
	MNE003594	M	PEKOVIC MILOS	12 Yrs Kumite Male 52+ kg	
	MNE03036	M	PEROVIC BORIS	13 Yrs Kata Individual Male	
	MNE03036	M	PEROVIC BORIS	12-13 Yrs Kata Team Male	
	MNE003741	M	PESTERAC FILIP	12 Yrs Kata Individual Male	
	MNE004085	M	PETROVIC JOVAN	11 Yrs Kumite Male -35 kg	
	MNE003752	M	PETROVIC MATIJA	13 Yrs Kumite Male -45 kg	
	MNE004072	M	POLOVIC MARKO	10 Yrs Kata Individual Male	

30th Balkan Karate Championships for Children 202 ..

ENTRIES BY NATIONAL FEDERATION

As of 31 MAY 2026

Code	ID	Gender	Name	Event	Seeding
MNE	MNE004072	M	POLOVIC MARKO	10-11 Yrs Kata Team Male	
	MNE004086	M	POPOVIC DAMJAN	11 Yrs Kumite Male -40 kg	
	MNE003758	M	POPOVIC FILIP	13 Yrs Kumite Male 55+ kg	
	MNE02846	M	POPOVIC LAZAR	13 Yrs Kata Individual Male	
	MNE02846	M	POPOVIC LAZAR	12-13 Yrs Kata Team Male	
	MNE004056	M	PRELEVIC DJORDJE	10 Yrs Kumite Male -45 kg	
	MNE004089	M	RADINOVIC PETAR	12 Yrs Kumite Male -42 kg	
	MNE003630	M	RADOJEVIC FILIP	12 Yrs Kata Individual Male	
	MNE003816	M	RADOVIC MATIJA	12 Yrs Kumite Male -42 kg	
	MNE003586	M	SAKOVIC FILIP	12 Yrs Kumite Male -37 kg	
	MNE03327	M	SAMARDZIC UROS	13 Yrs Kumite Male 55+ kg	
	MNE004052	M	SAVIC PAVLE	10 Yrs Kumite Male -30 kg	
	MNE003893	M	SEKULARAC STRAHINJA	9 Yrs Kata Individual Male	
	MNE003893	M	SEKULARAC STRAHINJA	8-9 Yrs Kata Team Male	
	MNE003617	M	SELLOVIQ UZEJR	13 Yrs Kata Individual Male	
	MNE003617	M	SELLOVIQ UZEJR	12-13 Yrs Kata Team Male	
	MNE003844	M	SKRIJELJ EROL	11 Yrs Kumite Male 50+ kg	
	MNE003587	M	SPAIC DANILO	12 Yrs Kumite Male -47 kg	
	MNE03112	M	SULEIC DJORDJE	12 Yrs Kata Individual Male	
	MNE03378	M	TOMASEVIC VUK	13 Yrs Kumite Male -40 kg	
	MNE004081	M	TOMIC VASILJE	10-11 Yrs Kata Team Male	
	MNE003627	M	TOSIC TEODOR	10 Yrs Kata Individual Male	
	MNE003627	M	TOSIC TEODOR	10-11 Yrs Kata Team Male	
	MNE003576	M	VLAOVIC STEFAN	13 Yrs Kumite Male -50 kg	
	MNE003750	M	VOJINOVIC VIKTOR	13 Yrs Kumite Male -40 kg	
	MNE03290	M	VUKMARKOVIC DAVID	12 Yrs Kata Individual Male	
	MNE03290	M	VUKMARKOVIC DAVID	12-13 Yrs Kata Team Male	
	MNE003622	M	VUKMARKOVIC VIKTOR	10 Yrs Kata Individual Male	
	MNE003622	M	VUKMARKOVIC VIKTOR	10-11 Yrs Kata Team Male	
	MNE003760	M	VUKOVIC VASILJE	13 Yrs Kumite Male 55+ kg	
	MNE003836	M	VUKOVIC VIKTOR	11 Yrs Kumite Male -45 kg	
	MNE004044	M	ZEKOVIC KOCA	8 Yrs Kata Individual Male	
	MNE004044	M	ZEKOVIC KOCA	8-9 Yrs Kata Team Male	
	MNE03303	F	AJKOVIC MIJA	12 Yrs Kata Individual Female	
	MNE03303	F	AJKOVIC MIJA	12 Yrs Kumite Female -50 kg	
	MNE004035	F	AJRA VELIQ	12 Yrs Kumite Female 50+ kg	
	MNE003872	F	ALEKSIC OLGA	12 Yrs Kumite Female -45 kg	
	MNE004049	F	BABIC TIJANA	8 Yrs Kata Individual Female	
	MNE004049	F	BABIC TIJANA	8-9 Yrs Kata Team Female	
	MNE004038	F	BAJOVIC HELENA	12 Yrs Kumite Female -40 kg	
	MNE003596	F	BLECIC JOVANA	12 Yrs Kumite Female -40 kg	
	MNE004026	F	BOGDANOVIC SOFIJA	12 Yrs Kata Individual Female	
	MNE003597	F	BOJANIC KSENIJA	12 Yrs Kumite Female -40 kg	
	MNE03311	F	BOSKOVIC LUNA	13 Yrs Kata Individual Female	
	MNE03311	F	BOSKOVIC LUNA	12-13 Yrs Kata Team Female	
	MNE004082	F	BOSKOVIC MONA	10-11 Yrs Kata Team Female	
	MNE03293	F	BRACIC ISIDORA	13 Yrs Kata Individual Female	
	MNE003607	F	BRAJKOVIC ANA	12 Yrs Kumite Female 50+ kg	

30th Balkan Karate Championships for Children 202 ..

ENTRIES BY NATIONAL FEDERATION

As of 31 MAY 2026

Code	ID	Gender	Name	Event	Seeding
MNE	MNE003808	F	BRAUNOVIC NADJA	9 Yrs Kata Individual Female	
	MNE003808	F	BRAUNOVIC NADJA	8-9 Yrs Kata Team Female	
	MNE03055	F	BULATOVIC MIA	12 Yrs Kata Individual Female	
	MNE03055	F	BULATOVIC MIA	12-13 Yrs Kata Team Female	
	MNE003770	F	BULATOVIC MILJANA	9 Yrs Kata Individual Female	
	MNE003770	F	BULATOVIC MILJANA	8-9 Yrs Kata Team Female	
	MNE003776	F	BULATOVIC NADJA	10 Yrs Kata Individual Female	
	MNE003776	F	BULATOVIC NADJA	10-11 Yrs Kata Team Female	
	MNE003771	F	BURZANOVIC KALINA	9 Yrs Kata Individual Female	
	MNE003850	F	CAUSEVIC EMA	11 Yrs Kata Individual Female	
	MNE003857	F	CAVOR NADJA	11 Yrs Kumite Female -32 kg	
	MNE003861	F	CICMIL KSENIJA	11 Yrs Kumite Female -40 kg	
	MNE03340	F	CVIJOVIC VALENTINA	13 Yrs Kumite Female -54 kg	
	MNE004059	F	DABOVIC STASA	10 Yrs Kumite Female -30 kg	
	MNE003878	F	DAMJANOVIC NIKOLINA	11 Yrs Kumite Female -40 kg	
	MNE03331	F	DJOKIC KRISTINA	13 Yrs Kumite Female -54 kg	
	MNE003604	F	DJONBALJAJ ASIJA	12 Yrs Kumite Female -50 kg	
	MNE003874	F	DJUKANOVIC ANJA	12 Yrs Kumite Female -40 kg	
	MNE03056	F	DJUKOVIC STEFANI	12-13 Yrs Kata Team Female	
	MNE003777	F	DJURICIC ANJA	10 Yrs Kata Individual Female	
	MNE003777	F	DJURICIC ANJA	10-11 Yrs Kata Team Female	
	MNE003599	F	DJUROVIC ANDJELA	12 Yrs Kumite Female -40 kg	
	MNE004080	F	DJUROVIC MILICA	12 Yrs Kata Individual Female	
	MNE03294	F	DRACA LANA	12 Yrs Kata Individual Female	
	MNE03294	F	DRACA LANA	12-13 Yrs Kata Team Female	
	MNE004030	F	DURAKU HUMEIJRA	13 Yrs Kumite Female 54+ kg	
	MNE004031	F	ELENA DUMIC	13 Yrs Kumite Female -54 kg	
	MNE003582	F	GECAJ ANJA	13 Yrs Kumite Female 54+ kg	
	MNE003595	F	GRBOVIC ITANA	12 Yrs Kumite Female -35 kg	
	MNE004079	F	HODZIC NADILA	12 Yrs Kata Individual Female	
	MNE004079	F	HODZIC NADILA	12-13 Yrs Kata Team Female	
	MNE004078	F	ITANOVIC ELENA	11 Yrs Kata Individual Female	
	MNE003775	F	JANCIC JANA	10 Yrs Kata Individual Female	
	MNE003775	F	JANCIC JANA	10-11 Yrs Kata Team Female	
	MNE03324	F	JANKOVIC JELENA	13 Yrs Kumite Female -49 kg	
	MNE004066	F	JEVDJEVIC LAURA	10 Yrs Kumite Female -40 kg	
	MNE003605	F	KACAR MILA	12 Yrs Kumite Female 50+ kg	
	MNE03326	F	KOMAR ANGELINA	13 Yrs Kumite Female -44 kg	
	MNE003794	F	KORDIC SOFIJA	13 Yrs Kumite Female -44 kg	
	MNE004062	F	KOSTIC LJUBICA	10 Yrs Kata Individual Female	
	MNE004062	F	KOSTIC LJUBICA	10 Yrs Kumite Female -34 kg	
	MNE003882	F	KOSTIC NIKOLINA	11 Yrs Kumite Female 44+ kg	
	MNE003625	F	KOVACEVIC MILICA	10 Yrs Kumite Female -30 kg	
	MNE003858	F	KRIVOKAPIC MIA	11 Yrs Kumite Female -32 kg	
	MNE02847	F	KRULJ NINA	13 Yrs Kata Individual Female	
	MNE004071	F	LALIC ANJA	9 Yrs Kata Individual Female	
	MNE004037	F	LISICIC KATARINA	12 Yrs Kumite Female -50 kg	
	MNE003802	F	LUKIC ANDJELA	13 Yrs Kumite Female -49 kg	

30th Balkan Karate Championships for Children 202 ..

ENTRIES BY NATIONAL FEDERATION

As of 31 MAY 2026

Code	ID	Gender	Name	Event	Seeding
MNE	MNE004065	F	MARAS MATEA	10 Yrs Kumite Female -40 kg	
	MNE003880	F	MIHAILOVIC SOFIJA	11 Yrs Kumite Female 44+ kg	
	MNE003866	F	MILANOVIC DARIJA	11 Yrs Kumite Female -36 kg	
	MNE003885	F	MILOSEVIC ANGELINA	11 Yrs Kumite Female 44+ kg	
	MNE03309	F	MILOSEVIC MINA	11 Yrs Kata Individual Female	
	MNE004050	F	NEDOVIC ELENA	8 Yrs Kata Individual Female	
	MNE004050	F	NEDOVIC ELENA	8-9 Yrs Kata Team Female	
	MNE004058	F	NENEZIC TEODORA	10 Yrs Kumite Female -30 kg	
	MNE004033	F	NIKOLINA KILIBARDA	13 Yrs Kumite Female -44 kg	
	MNE003804	F	NIKOVIC ERINA	13 Yrs Kumite Female 54+ kg	
	MNE004064	F	OSMAJIC SOFIJA	10 Yrs Kumite Female -37 kg	
	MNE003853	F	PAVLICIC ANDREA	13 Yrs Kata Individual Female	
	MNE003853	F	PAVLICIC ANDREA	12-13 Yrs Kata Team Female	
	MNE03057	F	PAVLOVIC ANA	12 Yrs Kata Individual Female	
	MNE03057	F	PAVLOVIC ANA	12-13 Yrs Kata Team Female	
	MNE004077	F	PELICIC BOZICA	10 Yrs Kumite Female 40+ kg	
	MNE004061	F	PERISIC ANA	10 Yrs Kumite Female -34 kg	
	MNE03333	F	PILJEVIC MILENA	13 Yrs Kumite Female -44 kg	
	MNE003774	F	POPOVIC LAURA	9 Yrs Kata Individual Female	
	MNE003774	F	POPOVIC LAURA	8-9 Yrs Kata Team Female	
	MNE004067	F	POPOVIC NIKOLINA	10 Yrs Kumite Female 40+ kg	
	MNE003869	F	POPOVIC TIJANA	12 Yrs Kumite Female -35 kg	
	MNE003799	F	PREKIC EMINA	13 Yrs Kumite Female 54+ kg	
	MNE03334	F	PRELEVIC MIA	13 Yrs Kumite Female 54+ kg	
	MNE03296	F	PRELEVIC VASILISA	11 Yrs Kata Individual Female	
	MNE003581	F	PRLJA IRINA	13 Yrs Kumite Female 54+ kg	
	MNE003879	F	RADINOVIC STASA	11 Yrs Kumite Female -44 kg	
	MNE004063	F	RADOSAVLJEVIC SOFIJA	10 Yrs Kumite Female -34 kg	
	MNE003619	F	RADULOVIC ANJA	11 Yrs Kata Individual Female	
	MNE003619	F	RADULOVIC ANJA	10-11 Yrs Kata Team Female	
	MNE004039	F	RADULOVIC SOFIJA	12 Yrs Kumite Female -35 kg	
	MNE003778	F	RADUNOVIC NINA	10 Yrs Kata Individual Female	
	MNE003883	F	RALIC ISKRA	11 Yrs Kumite Female 44+ kg	
	MNE03286	F	RASPOPOVIC GLORIJA	11 Yrs Kata Individual Female	
	MNE03286	F	RASPOPOVIC GLORIJA	10-11 Yrs Kata Team Female	
	MNE03285	F	RASPOPOVIC SOFIJA	13 Yrs Kata Individual Female	
	MNE003877	F	ROVCANIN NADJA	11 Yrs Kumite Female -40 kg	
	MNE004032	F	RUMEJSA PEROVIC	13 Yrs Kumite Female -44 kg	
	MNE003881	F	SAHMAN DAJANA	11 Yrs Kumite Female 44+ kg	
	MNE003779	F	SELLOVIQ ELIF	10 Yrs Kata Individual Female	
	MNE003769	F	SESTOVIC MASA	9 Yrs Kata Individual Female	
	MNE003769	F	SESTOVIC MASA	8-9 Yrs Kata Team Female	
	MNE003848	F	SHABANOVIQ IRSI	11 Yrs Kata Individual Female	
	MNE003848	F	SHABANOVIQ IRSI	10-11 Yrs Kata Team Female	
	MNE003800	F	SOKOVIC LANA	13 Yrs Kumite Female -54 kg	
	MNE003846	F	SUKALIC ARJANITA	13 Yrs Kata Individual Female	
	MNE004036	F	TAIBA BADZIC	12 Yrs Kumite Female 50+ kg	
	MNE003876	F	TODOROVIC MASA	11 Yrs Kumite Female -36 kg	

30th Balkan Karate Championships for Children 202 ..

ENTRIES BY NATIONAL FEDERATION

As of 31 MAY 2026

Code	ID	Gender	Name	Event	Seeding
MNE	MNE004073	F	TOSIC TEONA	10 Yrs Kata Individual Female	
	MNE004083	F	VODOPIC ZAJNEBA	12-13 Yrs Kata Team Female	
	MNE003854	F	VODOPIC ZEJNEBA	13 Yrs Kata Individual Female	
	MNE003600	F	VUJOSEVIC TEODORA	12 Yrs Kumite Female -45 kg	
	MNE003871	F	VUJOVIC DARIJA	12 Yrs Kumite Female -35 kg	
	MNE003862	F	ZARIC ISKRA	11 Yrs Kumite Female -36 kg	
	MNE003601	F	ZIVKOVIC KATARINA	12 Yrs Kumite Female -45 kg	
MKD	MKD003796	M	ALEKSOVSKI STEFAN	10 Yrs Kumite Male -45 kg	
	MKD003592	M	ANGJELOVSKI TEODOR	13 Yrs Kumite Male 55+ kg	
	MKD003798	M	ASHANI ZEJD	13 Yrs Kumite Male -55 kg	
	MKD003405	M	BASAROV PAVEL	12 Yrs Kumite Male 52+ kg	
	MKD003638	M	DAVCHEV JORDAN	11 Yrs Kata Individual Male	
	MKD003638	M	DAVCHEV JORDAN	10-11 Yrs Kata Team Male	
	MKD003812	M	DAVITKOVSKI DAVID	10 Yrs Kumite Male -40 kg	
	MKD003790	M	DIMITROV ZLATKO	10 Yrs Kata Individual Male	
	MKD003790	M	DIMITROV ZLATKO	10-11 Yrs Kata Team Male	
	MKD003622	M	EMINI ELTIN	11 Yrs Kumite Male -35 kg	
	MKD003621	M	EMINI ERBLIN	12 Yrs Kumite Male -37 kg	
	MKD003804	M	GJURIKJ SERGEJ	10 Yrs Kata Individual Male	
	MKD003804	M	GJURIKJ SERGEJ	10-11 Yrs Kata Team Male	
	MKD003807	M	GOCEVSKI NENAD	10 Yrs Kata Individual Male	
	MKD003417	M	ILIEVSKI IVAN	13 Yrs Kata Individual Male	
	MKD003417	M	ILIEVSKI IVAN	12-13 Yrs Kata Team Male	
	MKD003808	M	JANESKI DIMITAR	11 Yrs Kata Individual Male	
	MKD003808	M	JANESKI DIMITAR	10-11 Yrs Kata Team Male	
	MKD003605	M	JANEVSKI DAMJAN	12 Yrs Kumite Male -52 kg	
	MKD03236	M	JOVANOV ALEKSANDAR	13 Yrs Kata Individual Male	
	MKD03236	M	JOVANOV ALEKSANDAR	12-13 Yrs Kata Team Male	
	MKD003791	M	JOVANOVSKI NIKOLA	11 Yrs Kata Individual Male	
	MKD003791	M	JOVANOVSKI NIKOLA	10-11 Yrs Kata Team Male	
	MKD003810	M	KOSTOVSKI KIRE	13 Yrs Kumite Male 55+ kg	
	MKD003795	M	LEVICHAROV TEO	12 Yrs Kumite Male -42 kg	
	MKD003607	M	LUMA UNEJS	11 Yrs Kumite Male -40 kg	
	MKD003805	M	MANTAROSKI GORAZD	10 Yrs Kata Individual Male	
	MKD003805	M	MANTAROSKI GORAZD	10-11 Yrs Kata Team Male	
	MKD003806	M	MOMIROSKI FILIP	10 Yrs Kata Individual Male	
	MKD003806	M	MOMIROSKI FILIP	10-11 Yrs Kata Team Male	
	MKD003620	M	MUSTAFA AULON	11 Yrs Kumite Male -50 kg	
	MKD003414	M	NEZIRI EBUBEKR	12 Yrs Kumite Male -42 kg	
	MKD003809	M	NUNESKI ANTONIO	12 Yrs Kata Individual Male	
	MKD003457	M	OGNEVSKI SIMON	12 Yrs Kata Individual Male	
	MKD003793	M	PETKOVSKI NIKOLAJ	10 Yrs Kata Individual Male	
	MKD003793	M	PETKOVSKI NIKOLAJ	10 Yrs Kumite Male -45 kg	
	MKD003591	M	PETROVSKI ALEKSANDAR	11 Yrs Kumite Male -35 kg	
	MKD003811	M	RISTOV ALEKSEJ	10 Yrs Kumite Male -35 kg	
	MKD03251	M	SELIMI ISA	13 Yrs Kumite Male -45 kg	
	MKD003585	M	SIMEONOV DAMJAN	12 Yrs Kumite Male -37 kg	

30th Balkan Karate Championships for Children 202 ..

ENTRIES BY NATIONAL FEDERATION

As of 31 MAY 2026

Code	ID	Gender	Name	Event	Seeding
MKD	MKD003799	M	SULEJMANI NOAR	10 Yrs Kumite Male -35 kg	
	MKD003578	M	TASEVSKI MIHAIL	11 Yrs Kumite Male -45 kg	
	MKD02706	M	TODOROVSKI STEFAN	12 Yrs Kata Individual Male	
	MKD03272	M	TRENDAFILOV VASILIJ	13 Yrs Kata Individual Male	
	MKD03272	M	TRENDAFILOV VASILIJ	12-13 Yrs Kata Team Male	
	MKD003814	F	ANISIA NACEV	11 Yrs Kumite Female -44 kg	
	MKD003792	F	BOSHKOVA BOJANA	11 Yrs Kata Individual Female	
	MKD003792	F	BOSHKOVA BOJANA	10-11 Yrs Kata Team Female	
	MKD003794	F	CHOCHEVA ANDREA	10 Yrs Kata Individual Female	
	MKD003794	F	CHOCHEVA ANDREA	10-11 Yrs Kata Team Female	
	MKD003802	F	DIMITRIOSKA JOVANA	11 Yrs Kata Individual Female	
	MKD003802	F	DIMITRIOSKA JOVANA	10-11 Yrs Kata Team Female	
	MKD003635	F	ILIEVA OLGICA	11 Yrs Kumite Female -32 kg	
	MKD003599	F	ILIEVSKA DORA	12 Yrs Kumite Female -50 kg	
	MKD003608	F	IMERI MELDA	11 Yrs Kumite Female -32 kg	
	MKD003608	F	IMERI MELDA	10-11 Yrs Kata Team Female	
	MKD003614	F	KADRI MELDA	11 Yrs Kumite Female -40 kg	
	MKD003803	F	KONESKA JOVANA	11 Yrs Kata Individual Female	
	MKD003803	F	KONESKA JOVANA	10-11 Yrs Kata Team Female	
	MKD003439	F	KOSTADINOVA ILINA	13 Yrs Kumite Female -49 kg	
	MKD003447	F	KRSTEVSKA KALINA	12 Yrs Kata Individual Female	
	MKD003434	F	LOKI ERINA	12 Yrs Kumite Female -50 kg	
	MKD03267	F	MURTEZANI ADA	13 Yrs Kumite Female -49 kg	
	MKD03245	F	NEDELICHEVA SIMONA	13 Yrs Kata Individual Female	
	MKD003813	F	RISTOVA LANA	11 Yrs Kumite Female 44+ kg	
	MKD003800	F	SELMANI BERNA	10 Yrs Kata Individual Female	
	MKD003800	F	SELMANI BERNA	10 Yrs Kumite Female -30 kg	
	MKD003800	F	SELMANI BERNA	10-11 Yrs Kata Team Female	
	MKD003801	F	STOJANOSKA DOROTEA	10 Yrs Kata Individual Female	
	MKD003801	F	STOJANOSKA DOROTEA	10-11 Yrs Kata Team Female	
	MKD003634	F	TASEVSKA JOVANA	13 Yrs Kumite Female -54 kg	
	MKD003797	F	TEMKOVA ANGELA	12 Yrs Kumite Female 50+ kg	
	MKD003815	F	VELKOVSKA KAJA	12 Yrs Kumite Female -40 kg	
	ROU	ROU003880	M	CALIN NICOLAE-PINDARU	12 Yrs Kumite Male -47 kg
ROU003861		M	DRAGOS DUMITRU	13 Yrs Kumite Male -45 kg	
ROU004285		M	DRODU EDUARD MARIAN	10 Yrs Kumite Male -30 kg	
ROU004090		M	FILIP CARACOSTEA	11 Yrs Kumite Male -50 kg	
ROU004304		M	GEORGESCU DAVID	12 Yrs Kumite Male -42 kg	
ROU004302		M	GONEA THEODOR	12 Yrs Kumite Male -37 kg	
ROU004296		M	IACOB IOAN DAVID	10 Yrs Kumite Male -45 kg	
ROU004271		M	IONITA MATEI ANDREI	12 Yrs Kata Individual Male	
ROU004301		M	MIU RARES	10 Yrs Kumite Male -40 kg	
ROU004283		M	MUSAT DARIUS	11 Yrs Kumite Male -35 kg	
ROU004297		M	PASALAU VLAD	11 Yrs Kumite Male -40 kg	
ROU03627		M	PEREVOSCICOV GHERMAN	13 Yrs Kumite Male -50 kg	
ROU004267		M	PROFIROIU MATEI STEFAN	10 Yrs Kata Individual Male	
ROU004267		M	PROFIROIU MATEI STEFAN	10 Yrs Kumite Male -30 kg	

30th Balkan Karate Championships for Children 202 ..

ENTRIES BY NATIONAL FEDERATION

As of 31 MAY 2026

Code	ID	Gender	Name	Event	Seeding
ROU	ROU004308	M	ROSCHITA ANDREI	13 Yrs Kumite Male -55 kg	
	ROU004309	M	SAVULESCU VLAD DIMITRIE	10 Yrs Kumite Male -35 kg	
	ROU004295	M	STATE BOGDAN	10 Yrs Kumite Male -40 kg	
	ROU003881	M	STEFAN DRAGOS IAVNIC	12 Yrs Kumite Male -47 kg	
	ROU004284	M	VASILE GABRIEL	10 Yrs Kumite Male -30 kg	
	ROU004286	M	VLAD ANDREI JUSTINIAN	11 Yrs Kata Individual Male	
	ROU003882	M	VLAD DIMITRIE TRAIAN	12 Yrs Kumite Male -47 kg	
	ROU003866	F	ANA SOFIA CONSTANTIN	13 Yrs Kumite Female -49 kg	
	ROU003873	F	ANTONIA APOSTOL	13 Yrs Kumite Female -49 kg	
	ROU004313	F	BOLINTIRU DELIA ANTONIA	12 Yrs Kumite Female -45 kg	
	ROU004269	F	CANA ISABELLA	12 Yrs Kata Individual Female	
	ROU004269	F	CANA ISABELLA	12 Yrs Kumite Female -50 kg	
	ROU004298	F	CARABASI IRINA	12 Yrs Kumite Female -45 kg	
	ROU004266	F	CHELES ANDREEA	10 Yrs Kata Individual Female	
	ROU004266	F	CHELES ANDREEA	10 Yrs Kumite Female -34 kg	
	ROU004265	F	CHELES ANTONIA	13 Yrs Kata Individual Female	
	ROU004265	F	CHELES ANTONIA	13 Yrs Kumite Female -54 kg	
	ROU004281	F	CRETU ANTONIA MEDEEA	10 Yrs Kumite Female -30 kg	
	ROU004305	F	DIMA IOANA AMALIA	12 Yrs Kumite Female -35 kg	
	ROU004288	F	DINU TODORA	10 Yrs Kumite Female -34 kg	
	ROU003872	F	EVA TINCU	13 Yrs Kumite Female -44 kg	
	ROU004270	F	FLOREA DARIA	12 Yrs Kata Individual Female	
	ROU003876	F	GABRIELA POPA	13 Yrs Kumite Female -49 kg	
	ROU004272	F	GHEORGHE ERIKA	12 Yrs Kumite Female -50 kg	
	ROU004289	F	GINTU ADELINA MARIA	13 Yrs Kumite Female 54+ kg	
	ROU004287	F	GLINESCHE RAYSSA	12 Yrs Kumite Female -40 kg	
	ROU004306	F	GRIPCA ADRIANA	12 Yrs Kumite Female -40 kg	
	ROU004280	F	ISTRATE CAMELIA	10 Yrs Kumite Female -30 kg	
	ROU03598	F	KELEMEN ANDREEA	13 Yrs Kumite Female 54+ kg	
	ROU004303	F	MARHAN REBECA	10 Yrs Kumite Female -40 kg	
	ROU003878	F	MIRUNA COMAN	13 Yrs Kumite Female -54 kg	
	ROU004294	F	NASTAS NATALIA	12 Yrs Kumite Female -35 kg	
	ROU003858	F	NATALIA ZUBCU	12 Yrs Kumite Female -45 kg	
	ROU004291	F	NITA MARIA	12 Yrs Kata Individual Female	
	ROU004291	F	NITA MARIA	12 Yrs Kumite Female -45 kg	
	ROU004290	F	PARASCHIV MAYA ELENA	11 Yrs Kata Individual Female	
	ROU004290	F	PARASCHIV MAYA ELENA	11 Yrs Kumite Female -32 kg	
	ROU004307	F	PAVEL DIANA ANDREEA	12 Yrs Kumite Female 50+ kg	
	ROU004276	F	PETRE SOFIA MARIA	12 Yrs Kumite Female -50 kg	
	ROU004292	F	PETRESCU ALEXIA	12 Yrs Kumite Female 50+ kg	
	ROU004268	F	POPA LARISA MARIA	10 Yrs Kata Individual Female	
	ROU004275	F	POPOIU GIULIA IOANA	13 Yrs Kumite Female -44 kg	
	ROU004293	F	POTIRNICHE TIANA	11 Yrs Kata Individual Female	
	ROU004293	F	POTIRNICHE TIANA	11 Yrs Kumite Female -40 kg	
	ROU004300	F	PREDA ANAIS	11 Yrs Kumite Female -40 kg	
	ROU003879	F	RIANA NASTASA	12 Yrs Kumite Female -45 kg	
	ROU004299	F	ROTARU MARIA	12 Yrs Kata Individual Female	
	ROU003877	F	SOFIA GROSU	13 Yrs Kumite Female -54 kg	

30th Balkan Karate Championships for Children 202 ..

ENTRIES BY NATIONAL FEDERATION

As of 31 MAY 2026

Code	ID	Gender	Name	Event	Seeding
ROU	ROU003874	F	SOPHIA ISTRATE	13 Yrs Kumite Female -49 kg	
	ROU004278	F	STEFAN DIANA	11 Yrs Kumite Female -36 kg	
	ROU004282	F	TINCU MAIA	10 Yrs Kumite Female -37 kg	
	ROU004279	F	TOMA REBECCA MARIA	11 Yrs Kumite Female -40 kg	
	ROU004274	F	VOICU AISHA	13 Yrs Kumite Female -44 kg	
SRB	SRB004347	M	ADZIC LUKA	13 Yrs Kumite Male -50 kg	
	SRB004375	M	ARSIC FILIP	13 Yrs Kata Individual Male	
	SRB004375	M	ARSIC FILIP	12-13 Yrs Kata Team Male	
	SRB004592	M	ATANASOV IVAN	12 Yrs Kumite Male -37 kg	
	SRB04047	M	AVRAMOVIC ALEKSANDAR	13 Yrs Kumite Male -50 kg	
	SRB004921	M	BACLIJA KNOCH MARKO	10 Yrs Kata Individual Male	
	SRB004921	M	BACLIJA KNOCH MARKO	10 Yrs Kumite Male -30 kg	
	SRB004665	M	BALANGO STEFAN	9 Yrs Kata Individual Male	
	SRB004665	M	BALANGO STEFAN	8-9 Yrs Kata Team Male	
	SRB004975	M	BELCA LAZAR	10 Yrs Kumite Male 45+ kg	
	SRB004888	M	BLAGOJEVIC NIKOLA	11 Yrs Kumite Male -40 kg	
	SRB004973	M	BODROZIC BALS	10 Yrs Kumite Male -30 kg	
	SRB04020	M	BOROJEVIC UROS	13 Yrs Kumite Male -40 kg	
	SRB004594	M	BOZIC TADIJA	12 Yrs Kumite Male -42 kg	
	SRB04087	M	BUGARCIC DESPOT	11 Yrs Kumite Male -35 kg	
	SRB004678	M	CEBIC NEMANJA	11 Yrs Kumite Male -45 kg	
	SRB004353	M	CEKELIS VUK	12 Yrs Kumite Male -42 kg	
	SRB004920	M	DAVITKOV DUSAN	10 Yrs Kumite Male 45+ kg	
	SRB004951	M	DJOKIC VUKASIN	12 Yrs Kata Individual Male	
	SRB04076	M	DJUKANOVIC UROS	11 Yrs Kata Individual Male	
	SRB004944	M	DRAZILOVIC LAZAR	13 Yrs Kumite Male -40 kg	
	SRB004972	M	GOLUBOVIC DANILO	13 Yrs Kumite Male -45 kg	
	SRB004614	M	GRMUSA UROS	13 Yrs Kumite Male -50 kg	
	SRB004890	M	GRUJIC VELJKO	11 Yrs Kumite Male -50 kg	
	SRB004610	M	HALAS MIHALJ	11 Yrs Kata Individual Male	
	SRB004884	M	IVANOVIC BOGDAN	12 Yrs Kumite Male -42 kg	
	SRB004579	M	IVANOVIC RADISAV	13 Yrs Kumite Male 55+ kg	
	SRB004577	M	JACOVIC JANKO	13 Yrs Kumite Male -55 kg	
	SRB03777	M	JAGODIC ANDRIJA	12 Yrs Kumite Male -47 kg	
	SRB03651	M	JEREMIC VIKTOR	13 Yrs Kata Individual Male	
	SRB004337	M	JOCIC ANDREJ	12 Yrs Kumite Male 52+ kg	
	SRB004646	M	JOKSIMOVIC DANILO	12 Yrs Kumite Male -37 kg	
	SRB004694	M	JOVANOVIC KONSTANTIN	10 Yrs Kata Individual Male	
	SRB004970	M	JOVANOVIC PAVLE	10 Yrs Kumite Male -45 kg	
	SRB004728	M	JOVANOVIC STRAHINJA	11 Yrs Kumite Male -35 kg	
	SRB004950	M	JOVANOVIC VUK	12 Yrs Kata Individual Male	
	SRB004725	M	JOVIC UROS	12 Yrs Kata Individual Male	
	SRB004619	M	KOVACEVIC OGNJEN	13 Yrs Kata Individual Male	
	SRB004619	M	KOVACEVIC OGNJEN	12-13 Yrs Kata Team Male	
	SRB004962	M	KRPESIC VUK	8-9 Yrs Kata Team Male	
	SRB004974	M	KRUNIC TADIJA	10 Yrs Kumite Male 45+ kg	
	SRB004889	M	LAZIC ALEKSA	11 Yrs Kumite Male -45 kg	

30th Balkan Karate Championships for Children 202 ..

ENTRIES BY NATIONAL FEDERATION

As of 31 MAY 2026

Code	ID	Gender	Name	Event	Seeding
SRB	SRB004909	M	LAZIC JANKO	9 Yrs Kata Individual Male	
	SRB004963	M	LAZIC LUKA	13 Yrs Kumite Male 55+ kg	
	SRB004354	M	LAZIC STEFAN	12 Yrs Kumite Male -52 kg	
	SRB004961	M	LEBEN GAVRILO	12 Yrs Kumite Male 52+ kg	
	SRB004923	M	LEPOSAVIC MIHAJLO	10 Yrs Kumite Male -35 kg	
	SRB04125	M	MACANOVIC VIDAK	13 Yrs Kumite Male 55+ kg	
	SRB04026	M	MAKSIMOVIC ALEKSA	13 Yrs Kumite Male -45 kg	
	SRB004953	M	MAKSIMOVIC MILUTIN	9 Yrs Kata Individual Male	
	SRB04062	M	MANOJLOVIC MARKO	13 Yrs Kata Individual Male	
	SRB04062	M	MANOJLOVIC MARKO	13 Yrs Kumite Male -45 kg	
	SRB004401	M	MATAVULJ VUKASIN	11 Yrs Kata Individual Male	
	SRB004401	M	MATAVULJ VUKASIN	10-11 Yrs Kata Team Male	
	SRB004955	M	MATIC LUKA	11 Yrs Kumite Male -40 kg	
	SRB004374	M	MIJATOVIC LAZAR	13 Yrs Kata Individual Male	
	SRB004374	M	MIJATOVIC LAZAR	12-13 Yrs Kata Team Male	
	SRB004402	M	MIJATOVIC MAKSIM	11 Yrs Kata Individual Male	
	SRB004402	M	MIJATOVIC MAKSIM	11 Yrs Kumite Male -40 kg	
	SRB004402	M	MIJATOVIC MAKSIM	10-11 Yrs Kata Team Male	
	SRB004885	M	MIKIC TODOR	12 Yrs Kumite Male -47 kg	
	SRB004404	M	MILEVSKI UROS	10 Yrs Kumite Male -35 kg	
	SRB004883	M	MILICEVIC LUKA	13 Yrs Kumite Male -50 kg	
	SRB004948	M	MILOSEVIC PAVLE	10 Yrs Kumite Male -35 kg	
	SRB004731	M	MIOCINOVIC LAZAR	12 Yrs Kumite Male -47 kg	
	SRB04111	M	MITROVIC ALEKSA	13 Yrs Kumite Male -45 kg	
	SRB004947	M	MLADENOVIC NIKOLA	11 Yrs Kumite Male 50+ kg	
	SRB03711	M	MLADENOVSKI BRANKO	12 Yrs Kata Individual Male	
	SRB004598	M	NIKOLIC PAVLE	12 Yrs Kumite Male 52+ kg	
	SRB004964	M	PAVLOVIC MAKSIM	8-9 Yrs Kata Team Male	
	SRB004892	M	PLAVSIC ALEKSA	10 Yrs Kumite Male -30 kg	
	SRB004893	M	PLAVSIC ANDRIJA	10 Yrs Kumite Male -35 kg	
	SRB004371	M	POPOV BOJAN	13 Yrs Kumite Male -40 kg	
	SRB004895	M	PUZOVIC MILOS	10 Yrs Kumite Male -45 kg	
	SRB03397	M	RADIVOJEVIC UROS	12 Yrs Kata Individual Male	
	SRB03397	M	RADIVOJEVIC UROS	12 Yrs Kumite Male 52+ kg	
	SRB004349	M	RADMILOVIC MILAN	13 Yrs Kata Individual Male	
	SRB004649	M	RADOICIC ALEKSA	12 Yrs Kumite Male -52 kg	
	SRB004977	M	RADOJCIN MARKO	13 Yrs Kumite Male -40 kg	
	SRB04122	M	RADOVIC LUKA	13 Yrs Kumite Male -50 kg	
	SRB004949	M	RADOVIC RELJA	10 Yrs Kumite Male 45+ kg	
	SRB004887	M	RADULOVIC MIHAILO	11 Yrs Kumite Male -35 kg	
	SRB004368	M	RANKOVIC ILIJA	13 Yrs Kumite Male -55 kg	
	SRB004894	M	RUSMIROVIC PETAR	10 Yrs Kumite Male -40 kg	
	SRB004917	M	SAVIC DUSAN	13 Yrs Kata Individual Male	
	SRB004720	M	SRECKOVIC DEJAN	12 Yrs Kumite Male -37 kg	
	SRB04027	M	SRECKOVIC MATEJA	13 Yrs Kumite Male -55 kg	
	SRB004928	M	STANOJEVIC DIMITRIJE	12 Yrs Kumite Male -37 kg	
	SRB004666	M	STEFANOVIC ALEKSA	9 Yrs Kata Individual Male	
	SRB004666	M	STEFANOVIC ALEKSA	8-9 Yrs Kata Team Male	

30th Balkan Karate Championships for Children 202 ..

ENTRIES BY NATIONAL FEDERATION

As of 31 MAY 2026

Code	ID	Gender	Name	Event	Seeding
SRB	SRB004926	M	STEFANOVIC SERGEJ	8 Yrs Kata Individual Male	
	SRB004926	M	STEFANOVIC SERGEJ	8-9 Yrs Kata Team Male	
	SRB004596	M	STEVIC UROS	12 Yrs Kumite Male -52 kg	
	SRB004578	M	TANASKOVIC MILAN	13 Yrs Kumite Male 55+ kg	
	SRB004603	M	TOMIC JOVAN	11 Yrs Kumite Male -50 kg	
	SRB004352	M	TRAJKOVIC FILIP	12 Yrs Kumite Male -47 kg	
	SRB004918	M	TRAJKOVIC MILOS	9 Yrs Kata Individual Male	
	SRB004946	M	TRIFUNOVIC MATEO	11 Yrs Kumite Male -35 kg	
	SRB004954	M	TRIFUNOVIC VELIMIR	8 Yrs Kata Individual Male	
	SRB004348	M	TRUMIC UROS	12 Yrs Kata Individual Male	
	SRB004609	M	UDOVICKI VUKASIN	12 Yrs Kata Individual Male	
	SRB004882	M	USKOKOVIC LAZAR	13 Yrs Kumite Male -50 kg	
	SRB004927	M	VELEMIR LAZAR	10 Yrs Kumite Male -45 kg	
	SRB004925	M	VELJKOVIC MIHAJLO	10 Yrs Kumite Male -40 kg	
	SRB004969	M	VELJKOVIC VUKASIN	10 Yrs Kumite Male -40 kg	
	SRB004929	M	VIDOVIC DANILO	12 Yrs Kumite Male -52 kg	
	SRB004914	M	VLAISAVLJEVIC ALEKSA	8 Yrs Kata Individual Male	
	SRB004914	M	VLAISAVLJEVIC ALEKSA	8-9 Yrs Kata Team Male	
	SRB004956	M	VUCETIC STRAHINJA	8 Yrs Kata Individual Male	
	SRB004956	M	VUCETIC STRAHINJA	8-9 Yrs Kata Team Male	
	SRB004403	M	VUCETIC TODOR	10 Yrs Kata Individual Male	
	SRB004403	M	VUCETIC TODOR	10-11 Yrs Kata Team Male	
	SRB004383	M	VUJIC VUKAN	13 Yrs Kumite Male -45 kg	
	SRB004604	M	VUJOVIC PAVLE	11 Yrs Kumite Male 50+ kg	
	SRB004722	M	VUKOTIC MARKO	11 Yrs Kata Individual Male	
	SRB004722	M	VUKOTIC MARKO	10-11 Yrs Kata Team Male	
	SRB004664	M	ZAPCEVSKI DUSAN	11 Yrs Kumite Male -40 kg	
	SRB004328	M	ZARKOVIC OGNJEN	12 Yrs Kumite Male -37 kg	
	SRB004945	M	ZIVANOVIC LAZAR	12 Yrs Kumite Male 52+ kg	
	SRB04098	M	ZIVKOVIC ALJOSA	11 Yrs Kumite Male -45 kg	
	SRB004896	M	ZIVKOVIC MILUTIN	10 Yrs Kumite Male -45 kg	
	SRB004363	M	ZUGIC LUKA	13 Yrs Kumite Male -50 kg	
	SRB004906	F	BANOVIC MIONA	10 Yrs Kumite Female -34 kg	
	SRB004924	F	BARANOVSKI IRINA	10 Yrs Kumite Female -34 kg	
	SRB004942	F	BARRIER SOFIA	10 Yrs Kumite Female -30 kg	
	SRB004612	F	BENAK JOVANA	12-13 Yrs Kata Team Female	
	SRB004309	F	BEREZNI DUNJA	13 Yrs Kata Individual Female	
	SRB004309	F	BEREZNI DUNJA	12-13 Yrs Kata Team Female	
	SRB004922	F	BJEKOVIC TARA	10 Yrs Kumite Female -40 kg	
	SRB04091	F	BLAGOJEVIC MIRJANA	12 Yrs Kata Individual Female	
	SRB004350	F	BODROZIC ALEKSANDRA	12 Yrs Kata Individual Female	
	SRB004452	F	BODROZIC INA	12 Yrs Kumite Female -40 kg	
	SRB004960	F	BUNCIC MILA	8 Yrs Kata Individual Female	
	SRB03712	F	CORDASIC ELENA	12 Yrs Kata Individual Female	
	SRB004709	F	CUK JANA	10 Yrs Kata Individual Female	
	SRB004710	F	DAMLJANOVIC DUNJA	9 Yrs Kata Individual Female	
	SRB004710	F	DAMLJANOVIC DUNJA	8-9 Yrs Kata Team Female	
	SRB004730	F	DEVARNJA MILENA	12 Yrs Kumite Female -45 kg	

30th Balkan Karate Championships for Children 202 ..

ENTRIES BY NATIONAL FEDERATION

As of 31 MAY 2026

Code	ID	Gender	Name	Event	Seeding
SRB	SRB004339	F	DJORDJEVIC MIA	10 Yrs Kata Individual Female	
	SRB004339	F	DJORDJEVIC MIA	10-11 Yrs Kata Team Female	
	SRB004901	F	DJORDJIEVSKI DUNJA	10 Yrs Kumite Female -30 kg	
	SRB004935	F	DOLINGA ELENA	12 Yrs Kumite Female -40 kg	
	SRB004684	F	DOSIC NINA	12 Yrs Kumite Female 50+ kg	
	SRB004699	F	DOSTANIC ANJA	8-9 Yrs Kata Team Female	
	SRB03713	F	ERIC ELENA	12 Yrs Kumite Female 50+ kg	
	SRB004680	F	EROVIC VANJA	12 Yrs Kumite Female -45 kg	
	SRB004631	F	GRUJIC LENKA	12 Yrs Kumite Female -50 kg	
	SRB004376	F	GVOZDENOVIC TEODORA	12 Yrs Kumite Female -45 kg	
	SRB04068	F	HORVAT ISIDORA	13 Yrs Kumite Female -44 kg	
	SRB004338	F	IGIC ANDREA	11 Yrs Kata Individual Female	
	SRB004338	F	IGIC ANDREA	10-11 Yrs Kata Team Female	
	SRB004912	F	JEVDJENIJEVIC MINJA	12-13 Yrs Kata Team Female	
	SRB004886	F	JOKIC TARA	12 Yrs Kumite Female -50 kg	
	SRB004940	F	JOVANOVIC MASA	11 Yrs Kumite Female -44 kg	
	SRB004940	F	JOVANOVIC MASA	10-11 Yrs Kata Team Female	
	SRB004608	F	JOVANOVIC SARA	12 Yrs Kumite Female -40 kg	
	SRB004689	F	JOVIC MILA	11 Yrs Kumite Female -44 kg	
	SRB004657	F	KANDIC VISNJA	10 Yrs Kumite Female -37 kg	
	SRB004965	F	KAVURIN SARA	10 Yrs Kumite Female 40+ kg	
	SRB004691	F	KLICIC JELENA	13 Yrs Kumite Female -44 kg	
	SRB004933	F	KLICIC SELENA	13 Yrs Kumite Female -44 kg	
	SRB004931	F	KLINDO IVANA	11 Yrs Kumite Female -36 kg	
	SRB04066	F	KLJAJIC NADJA	13 Yrs Kumite Female -49 kg	
	SRB004897	F	KNEZEVIC TAMARA	11 Yrs Kumite Female -40 kg	
	SRB004620	F	KOVACEVIC LJILJANA	11 Yrs Kata Individual Female	
	SRB004910	F	KRIVACIC DANICA	8 Yrs Kata Individual Female	
	SRB004910	F	KRIVACIC DANICA	8-9 Yrs Kata Team Female	
	SRB004941	F	KRSTIC DUNJA	11 Yrs Kumite Female 44+ kg	
	SRB004959	F	KRSTIC HANA	8 Yrs Kata Individual Female	
	SRB04120	F	KRSTIC MILICA	13 Yrs Kumite Female -49 kg	
	SRB04090	F	LUKIC MASA	12 Yrs Kata Individual Female	
	SRB004939	F	LUKIC NINA	11 Yrs Kumite Female -40 kg	
	SRB03481	F	MAJKIC UNA	13 Yrs Kata Individual Female	
	SRB03718	F	MAJKIC UNA	12-13 Yrs Kata Team Female	
	SRB04063	F	MANOJLOVIC MILA	11 Yrs Kata Individual Female	
	SRB04063	F	MANOJLOVIC MILA	11 Yrs Kumite Female -32 kg	
	SRB03647	F	MANOJLOVIC SOFIJA	13 Yrs Kata Individual Female	
	SRB03647	F	MANOJLOVIC SOFIJA	13 Yrs Kumite Female -49 kg	
	SRB03647	F	MANOJLOVIC SOFIJA	12-13 Yrs Kata Team Female	
	SRB004966	F	MANOJLOVIC TIJANA	10-11 Yrs Kata Team Female	
	SRB004587	F	MARICEVIC NEDA	13 Yrs Kumite Female -54 kg	
	SRB004539	F	MARKOVIC TAMARA	12 Yrs Kata Individual Female	
	SRB004915	F	MARTI BOJANA	9 Yrs Kata Individual Female	
	SRB04067	F	MIJAILOVIC SOFIJA	13 Yrs Kumite Female -54 kg	
	SRB004653	F	MILETIC NIKOLINA	12 Yrs Kumite Female -35 kg	
	SRB04126	F	MILOSAVLJEVIC BOJANA	13 Yrs Kumite Female 54+ kg	

30th Balkan Karate Championships for Children 202 ..

ENTRIES BY NATIONAL FEDERATION

As of 31 MAY 2026

Code	ID	Gender	Name	Event	Seeding
SRB	SRB004323	F	MILOSEVIC MASA	13 Yrs Kumite Female -49 kg	
	SRB004633	F	MILOSEVIC TEODORA	12 Yrs Kumite Female 50+ kg	
	SRB004407	F	MIRIC DANKA	11 Yrs Kata Individual Female	
	SRB004407	F	MIRIC DANKA	10-11 Yrs Kata Team Female	
	SRB004934	F	MIRKOVIC JOVANA	13 Yrs Kumite Female -44 kg	
	SRB004589	F	MITROVIC LJUBICA	13 Yrs Kumite Female 54+ kg	
	SRB04092	F	MOMCILOVIC UNA	13 Yrs Kata Individual Female	
	SRB004356	F	MUZDEKA JOVANA	13 Yrs Kumite Female -54 kg	
	SRB004629	F	NESIC ISKRA	12 Yrs Kumite Female -40 kg	
	SRB004905	F	NESIC MAGDALENA	10 Yrs Kumite Female -34 kg	
	SRB004324	F	NIKOLIC ANDREA	12 Yrs Kumite Female -50 kg	
	SRB004634	F	NIKOLIC NINA	11 Yrs Kumite Female -40 kg	
	SRB03399	F	NOVKOVIC ANDJELIJA	13 Yrs Kata Individual Female	
	SRB03399	F	NOVKOVIC ANDJELIJA	12-13 Yrs Kata Team Female	
	SRB004705	F	OGNJAN ANASTASIJA	12 Yrs Kumite Female -40 kg	
	SRB04094	F	OSTOJIC JELENA	11 Yrs Kata Individual Female	
	SRB004932	F	PANIC JOVANA	12 Yrs Kumite Female -45 kg	
	SRB03717	F	PAVLOVIC DUNJA	13 Yrs Kata Individual Female	
	SRB03717	F	PAVLOVIC DUNJA	12-13 Yrs Kata Team Female	
	SRB03402	F	PAVLOVIC EMILIJA	13 Yrs Kumite Female -44 kg	
	SRB03402	F	PAVLOVIC EMILIJA	12-13 Yrs Kata Team Female	
	SRB004322	F	PAVLOVIC TINA	13 Yrs Kumite Female 54+ kg	
	SRB004325	F	PETROVIC LJUBICA	11 Yrs Kata Individual Female	
	SRB004325	F	PETROVIC LJUBICA	11 Yrs Kumite Female -40 kg	
	SRB04009	F	PETROVIC SENKA	13 Yrs Kumite Female -49 kg	
	SRB004911	F	PETROVIC TEODORA	10-11 Yrs Kata Team Female	
	SRB004938	F	POPADIC DUNJA	11 Yrs Kumite Female -32 kg	
	SRB004908	F	POPOVIC JOVANA	10 Yrs Kumite Female 40+ kg	
	SRB004708	F	PRTLJAGA MILICA	12 Yrs Kumite Female -45 kg	
	SRB004369	F	PRUSAC ANA	13 Yrs Kumite Female -54 kg	
	SRB004907	F	PUZOVIC LANA	10 Yrs Kumite Female -37 kg	
	SRB004899	F	RADETA SLADJANA	11 Yrs Kumite Female 44+ kg	
	SRB004976	F	RADNOVIC VANJA	12 Yrs Kumite Female -40 kg	
	SRB004663	F	RADOJKIC TEODORA	10 Yrs Kumite Female -30 kg	
	SRB004700	F	RADOMAN UNA	9 Yrs Kata Individual Female	
	SRB004700	F	RADOMAN UNA	8-9 Yrs Kata Team Female	
	SRB004686	F	RADOVANOVIC MASA	11 Yrs Kumite Female -36 kg	
	SRB04078	F	RAKAZOV MILICA	13 Yrs Kumite Female -39 kg	
	SRB004971	F	RANKOVIC SOFIJA	11 Yrs Kumite Female 44+ kg	
	SRB004958	F	RISTIC DUNJA	10 Yrs Kata Individual Female	
	SRB004943	F	RISTIC JANA	10 Yrs Kumite Female -34 kg	
	SRB004702	F	RISTOV ISIDORA	10 Yrs Kata Individual Female	
	SRB004919	F	ROBULJ TEODORA	12 Yrs Kata Individual Female	
	SRB04073	F	SEKULIC DUNJA	13 Yrs Kumite Female 54+ kg	
	SRB04096	F	SKRBIC SARA	11 Yrs Kata Individual Female	
	SRB004930	F	STEFANOVIC MIONA	10 Yrs Kumite Female 40+ kg	
	SRB04118	F	STEPANOVIC LENA	13 Yrs Kumite Female -39 kg	
	SRB004370	F	STOJANOVIC DUNJA	13 Yrs Kumite Female -54 kg	

30th Balkan Karate Championships for Children 202 ..

ENTRIES BY NATIONAL FEDERATION

As of 31 MAY 2026

Code	ID	Gender	Name	Event	Seeding
SRB	SRB004540	F	STRBAC MILA	11 Yrs Kumite Female -36 kg	
	SRB004937	F	TERZIC STASA	11 Yrs Kumite Female -32 kg	
	SRB004690	F	TODOROVIC MILA	11 Yrs Kumite Female 44+ kg	
	SRB004916	F	TRUMIC SARA	9 Yrs Kata Individual Female	
	SRB004701	F	UROSEVIC NIKOLINA	10 Yrs Kata Individual Female	
	SRB04049	F	VAGIC HELENA	13 Yrs Kumite Female 54+ kg	
	SRB03714	F	VASILJEVIC ANA	12 Yrs Kumite Female 50+ kg	
	SRB004739	F	VIDAKOVIC PETRA	13 Yrs Kata Individual Female	
	SRB004898	F	VOJINOVIC LENA	11 Yrs Kumite Female -44 kg	
	SRB004957	F	VUJIC STEFANI	10 Yrs Kata Individual Female	
	SRB004671	F	VUKOVIC DRAGANA	13 Yrs Kumite Female -49 kg	
	SRB004582	F	ZAFIROVIC LENA	13 Yrs Kumite Female -39 kg	
	SRB004900	F	ZARKOVIC IVA	10 Yrs Kumite Female -30 kg	
	SLO	SLO003173	M	GORICAN ZAN	13 Yrs Kumite Male -50 kg
SLO003065		F	MESIC BENJA	12 Yrs Kumite Female -50 kg	
TUR	TUR006288	M	AGAAGLU UMUT ARAS	8-9 Yrs Kata Team Male	
	TUR006115	M	AKAGUNDUZ CAGAN	11 Yrs Kumite Male -45 kg	
	TUR006190	M	AKAGUNDUZ KAAN	13 Yrs Kumite Male -40 kg	
	TUR005546	M	AKBAS MUSTAFA SAID	11 Yrs Kata Individual Male	
	TUR006040	M	AKBAY HASAN EREN	10 Yrs Kumite Male -35 kg	
	TUR006254	M	AKCAY FURKAN ABIDIN	11 Yrs Kata Individual Male	
	TUR006088	M	AKCAY OMER	11 Yrs Kumite Male -35 kg	
	TUR006255	M	AKDENIZ SELIM EGE	11 Yrs Kata Individual Male	
	TUR005667	M	AKGUN TAYLAN EGE	12 Yrs Kata Individual Male	
	TUR005667	M	AKGUN TAYLAN EGE	12-13 Yrs Kata Team Male	
	TUR006094	M	AKKUS EYMEN	11 Yrs Kumite Male -35 kg	
	TUR005051	M	AKSEN GOKTUG	12 Yrs Kumite Male -52 kg	
	TUR005097	M	AKSOY METEHAN	10-11 Yrs Kata Team Male	
	TUR006182	M	AKSU MEHMET AKIF	12 Yrs Kumite Male 52+ kg	
	TUR006232	M	AKTAS ASLAN	8 Yrs Kata Individual Male	
	TUR006064	M	AKYUZ DURSUN BERAT	10 Yrs Kumite Male -45 kg	
	TUR006130	M	AKYUZ MUHAMMED DENIZ	11 Yrs Kumite Male -50 kg	
	TUR006193	M	ALADAG MIRAC	13 Yrs Kumite Male -40 kg	
	TUR005121	M	ALBAYRAK EMIR SAHIN	13 Yrs Kumite Male -40 kg	
	TUR006068	M	ALP ALP TIGIN	10 Yrs Kumite Male -45 kg	
	TUR005662	M	ALTUNSU EMIRHAN	12 Yrs Kumite Male -42 kg	
	TUR006164	M	ARMAGAN SAID MIRZA	12 Yrs Kumite Male -47 kg	
	TUR006151	M	ARSLAN CETIN OMUR	12 Yrs Kumite Male -37 kg	
	TUR03977	M	AVINCSAL ZINAR DEVRAN	13 Yrs Kata Individual Male	
	TUR03977	M	AVINCSAL ZINAR DEVRAN	12-13 Yrs Kata Team Male	
	TUR006129	M	AYHAN OSMAN	11 Yrs Kumite Male -50 kg	
	TUR005632	M	AYKAN ALI OSMAN EGE	13 Yrs Kumite Male -50 kg	
	TUR006065	M	AYRAL ELYASA	10 Yrs Kumite Male -45 kg	
	TUR006286	M	AYTEKIN MIRAC	11 Yrs Kumite Male -40 kg	
	TUR006041	M	AYYILDIZ POYRAZ	10 Yrs Kumite Male -35 kg	
TUR006067	M	BABACAN ISMAIL YUSUF	10 Yrs Kumite Male -45 kg		
TUR006202	M	BAHADIR ERCAN	13 Yrs Kumite Male -45 kg		

30th Balkan Karate Championships for Children 202 ..

ENTRIES BY NATIONAL FEDERATION

As of 31 MAY 2026

Code	ID	Gender	Name	Event	Seeding
TUR	TUR006268	M	BALCI ASLAN	12-13 Yrs Kata Team Male	
	TUR006275	M	BARKOL AYBARS UFUK	10-11 Yrs Kata Team Male	
	TUR006185	M	BARUONU IRFAN RUZGAR	12 Yrs Kumite Male 52+ kg	
	TUR006208	M	BAS MUHAMMET ALI	13 Yrs Kumite Male -50 kg	
	TUR006262	M	BAY ALI EKBER	13 Yrs Kata Individual Male	
	TUR004937	M	BAYAR BERAT	13 Yrs Kumite Male -50 kg	
	TUR006036	M	BAYAR CAYAN ATES	10 Yrs Kumite Male -35 kg	
	TUR005691	M	BAYRAKTAR HALIT KAAAN	12 Yrs Kumite Male -42 kg	
	TUR005063	M	BEDIR ALI	12 Yrs Kumite Male -47 kg	
	TUR006215	M	BEYAZIT MUHAMMED TUNAHAN	13 Yrs Kumite Male -55 kg	
	TUR006127	M	BILGIN SELIM	11 Yrs Kumite Male -50 kg	
	TUR006092	M	BIRTURK HUSEYIN METE	11 Yrs Kumite Male -35 kg	
	TUR005120	M	BIYIKLI ATA	12-13 Yrs Kata Team Male	
	TUR04544	M	BOLUKBAS HUSEYIN TALHA	13 Yrs Kumite Male 55+ kg	
	TUR006150	M	BULBUL EYMEN	12 Yrs Kumite Male -37 kg	
	TUR006266	M	BULGAKOV ATTILA ASLAN	8 Yrs Kata Individual Male	
	TUR006136	M	BULUTCU AHMET	11 Yrs Kumite Male 50+ kg	
	TUR006184	M	BULUTOGLU OMER FARUK	12 Yrs Kumite Male 52+ kg	
	TUR006055	M	CAKMAK OMER	10 Yrs Kumite Male -40 kg	
	TUR006209	M	CAMLIBEL EMIR FATIH	13 Yrs Kumite Male -50 kg	
	TUR006038	M	CAN MUSTAFA	10 Yrs Kumite Male -35 kg	
	TUR006241	M	CEBECI OMER ASIM	9 Yrs Kata Individual Male	
	TUR006241	M	CEBECI OMER ASIM	8-9 Yrs Kata Team Male	
	TUR006152	M	CELEBI MEHMET AKIF	12 Yrs Kumite Male -37 kg	
	TUR005050	M	CELIK ALI EMIR	12 Yrs Kumite Male -42 kg	
	TUR006264	M	CETIN ALI ARAS	13 Yrs Kata Individual Male	
	TUR005669	M	CEVIK YUCEL	12 Yrs Kata Individual Male	
	TUR04592	M	CICEK MEHMET	11 Yrs Kata Individual Male	
	TUR006263	M	CINAR YAGIZ MIRAC	13 Yrs Kata Individual Male	
	TUR006263	M	CINAR YAGIZ MIRAC	12-13 Yrs Kata Team Male	
	TUR006042	M	CINAR YUNUS EMRE	10 Yrs Kumite Male -35 kg	
	TUR006140	M	CINBIZ FATIH EFE	11 Yrs Kumite Male 50+ kg	
	TUR006138	M	CUHADAR MUSTAFA	11 Yrs Kumite Male 50+ kg	
	TUR006245	M	CUVAL ERALP UMMUT	9 Yrs Kata Individual Male	
	TUR006093	M	DEGIRMENCI ARIF	11 Yrs Kumite Male -35 kg	
	TUR006210	M	DEMIR ALPEREN	13 Yrs Kumite Male -50 kg	
	TUR006103	M	DEMIR POYRAZ CINAR	11 Yrs Kumite Male -40 kg	
	TUR006089	M	DEREBAGI OMER EYMEN	11 Yrs Kumite Male -35 kg	
	TUR006242	M	DERECI RASIM POYRAZ	9 Yrs Kata Individual Male	
	TUR005056	M	DINLER GUNEY BAYRAM	12 Yrs Kumite Male -42 kg	
	TUR04588	M	DINLER KUZEY	13 Yrs Kumite Male -55 kg	
	TUR006023	M	DUNDERER OGUZ KAAAN	10 Yrs Kata Individual Male	
	TUR006023	M	DUNDERER OGUZ KAAAN	10 Yrs Kumite Male -30 kg	
	TUR005085	M	EFE ER OZEN EGEMEN	12 Yrs Kata Individual Male	
	TUR006234	M	EGE NACI EGEHAN	8 Yrs Kata Individual Male	
	TUR006158	M	EK BAHADIR	12 Yrs Kumite Male -42 kg	
	TUR006050	M	EKER ALP EREN	10 Yrs Kumite Male -40 kg	
	TUR006230	M	ERBASI BORA	8 Yrs Kata Individual Male	

30th Balkan Karate Championships for Children 202 ..

ENTRIES BY NATIONAL FEDERATION

As of 31 MAY 2026

Code	ID	Gender	Name	Event	Seeding
TUR	TUR004927	M	EREN ENVER ALP	12-13 Yrs Kata Team Male	
	TUR006213	M	ERKOL MIRAC	13 Yrs Kumite Male -55 kg	
	TUR005653	M	ERPINAR EGE	12 Yrs Kumite Male 52+ kg	
	TUR005623	M	ERTAS ATABERK	13 Yrs Kumite Male -45 kg	
	TUR004928	M	ESER KERIM ALI	13 Yrs Kata Individual Male	
	TUR006027	M	FERHATOGLU YUSUF YAMAN	10 Yrs Kumite Male -30 kg	
	TUR006113	M	GAZIOGLU CIHAN KARABEY	11 Yrs Kumite Male -45 kg	
	TUR006188	M	GELMEZ MERT ALI	13 Yrs Kumite Male -40 kg	
	TUR006201	M	GENCER HASAN HUSEYIN	13 Yrs Kumite Male -45 kg	
	TUR006053	M	GOIT KEREM	10 Yrs Kumite Male -40 kg	
	TUR006126	M	GOK EYMEN	11 Yrs Kumite Male -50 kg	
	TUR04594	M	GUDER MUSTAFA EREN	12 Yrs Kata Individual Male	
	TUR006106	M	GULLER BERK EMIR	11 Yrs Kumite Male -40 kg	
	TUR006166	M	GUMUSLU ALI	12 Yrs Kumite Male -47 kg	
	TUR005631	M	GUNES CAGAN	13 Yrs Kumite Male -50 kg	
	TUR006069	M	GUNGOR YIGIT EREN	10 Yrs Kumite Male -45 kg	
	TUR006168	M	GUNGORMUS EFE	12 Yrs Kumite Male -47 kg	
	TUR006054	M	GURCAN ALPKAN	10 Yrs Kumite Male -40 kg	
	TUR006214	M	GURSOY METEHAN	13 Yrs Kumite Male -55 kg	
	TUR006117	M	HAMARAT SEMIH	11 Yrs Kumite Male -45 kg	
	TUR006174	M	ICEL MIRAC	12 Yrs Kumite Male -52 kg	
	TUR004998	M	ICEN MEHMET	12 Yrs Kumite Male 52+ kg	
	TUR006247	M	ITIL MEHMET AYTUG	9 Yrs Kata Individual Male	
	TUR006026	M	KADIOGLU ALPARSLAN	10 Yrs Kumite Male -30 kg	
	TUR006221	M	KANISMAK EMIR	13 Yrs Kumite Male 55+ kg	
	TUR006063	M	KARA RUZGAR	10 Yrs Kumite Male -45 kg	
	TUR006049	M	KARAALI POYRAZ ATES	10 Yrs Kumite Male -40 kg	
	TUR006189	M	KARADAG MUHAMMET ALI	13 Yrs Kumite Male -40 kg	
	TUR006281	M	KARADENIZ EGEMEN YILMAZ	8-9 Yrs Kata Team Male	
	TUR04590	M	KARAGOZ ZEYNEL	13 Yrs Kata Individual Male	
	TUR006139	M	KARCI KAYRA	11 Yrs Kumite Male 50+ kg	
	TUR006080	M	KARGI ERDEM	10 Yrs Kumite Male 45+ kg	
	TUR004980	M	KARTAL MEHMET TALHA	13 Yrs Kumite Male 55+ kg	
	TUR005558	M	KAYA ENES ARDA	11 Yrs Kumite Male -45 kg	
	TUR006090	M	KAYA ISMAIL CUNEYT	11 Yrs Kumite Male -35 kg	
	TUR006116	M	KAYA MEHMET YEKTA	11 Yrs Kumite Male -45 kg	
	TUR006025	M	KAYMAK YUSUF SINAN	10 Yrs Kumite Male -30 kg	
	TUR006165	M	KAZANCIOGLU OMER MAHMUT	12 Yrs Kumite Male -47 kg	
	TUR006156	M	KELES AZAD YAGIZ	12 Yrs Kumite Male -42 kg	
	TUR006246	M	KESGIN MUHAMMET ALI	9 Yrs Kata Individual Male	
	TUR006283	M	KESKIN AYAZ	8-9 Yrs Kata Team Male	
	TUR005555	M	KILINC AHMET	11 Yrs Kumite Male -50 kg	
	TUR006078	M	KIRBAS MERT	10 Yrs Kumite Male 45+ kg	
	TUR006256	M	KIZILYAR ALI	11 Yrs Kata Individual Male	
	TUR006256	M	KIZILYAR ALI	10-11 Yrs Kata Team Male	
	TUR03976	M	KOC ABDULKADIR	13 Yrs Kata Individual Male	
	TUR004957	M	KODAK CINAR EFE	13 Yrs Kumite Male 55+ kg	
	TUR006024	M	KORKMAZ RAMAZAN TALHA	10 Yrs Kumite Male -30 kg	

30th Balkan Karate Championships for Children 202 ..

ENTRIES BY NATIONAL FEDERATION

As of 31 MAY 2026

Code	ID	Gender	Name	Event	Seeding
TUR	TUR006243	M	KOROGLU ALPEREN	9 Yrs Kata Individual Male	
	TUR006176	M	KOSEOGLU SELIM EMRE	12 Yrs Kumite Male -52 kg	
	TUR005108	M	KOTAN YAGIZ	10 Yrs Kata Individual Male	
	TUR006037	M	KUKUK POYRAZ	10 Yrs Kumite Male -35 kg	
	TUR006128	M	KURNAZ MUSAB YAGIZ	11 Yrs Kumite Male -50 kg	
	TUR006052	M	KUTUCU SELIM ERDOGAN	10 Yrs Kumite Male -40 kg	
	TUR004946	M	MENGUVERDI CINAR	13 Yrs Kumite Male -55 kg	
	TUR006022	M	ODEMIS MUSTAFA SAMIL	10 Yrs Kumite Male -30 kg	
	TUR006137	M	ORAL RUZGAR EFE	11 Yrs Kumite Male 50+ kg	
	TUR006066	M	OZ METEHAN	10 Yrs Kumite Male -45 kg	
	TUR006192	M	OZCELIK ARAS	13 Yrs Kumite Male -40 kg	
	TUR005999	M	OZDEMIR YUSUF SELMAN	13 Yrs Kumite Male -50 kg	
	TUR006287	M	OZDOGAN EMIR YAGIZ	8-9 Yrs Kata Team Male	
	TUR006175	M	OZGULTEKIN HARUN	12 Yrs Kumite Male -52 kg	
	TUR006083	M	OZGUR CAN	10 Yrs Kumite Male 45+ kg	
	TUR005105	M	OZKANOGLU CINAR ALP	10 Yrs Kata Individual Male	
	TUR005105	M	OZKANOGLU CINAR ALP	10-11 Yrs Kata Team Male	
	TUR006200	M	OZTURK FEHMI SELIM	13 Yrs Kumite Male -45 kg	
	TUR006252	M	OZYURT AYAZ EFE	10 Yrs Kata Individual Male	
	TUR006102	M	PAKKAN OSMAN EFE	11 Yrs Kumite Male -40 kg	
	TUR006233	M	PALDIR ASAF CAGAN	8 Yrs Kata Individual Male	
	TUR005579	M	PAYLI SIYAR	11 Yrs Kumite Male -40 kg	
	TUR04516	M	PEK AHMET	13 Yrs Kumite Male 55+ kg	
	TUR005663	M	PEKTAS EYMEN	11 Yrs Kumite Male 50+ kg	
	TUR006244	M	SADIK MERT ALI	9 Yrs Kata Individual Male	
	TUR006183	M	SAGLAM HAYDAR	12 Yrs Kumite Male 52+ kg	
	TUR006081	M	SAHIN CAN	10 Yrs Kumite Male 45+ kg	
	TUR004948	M	SAHIN DENIZ AREL	13 Yrs Kumite Male -45 kg	
	TUR006082	M	SAHIN ENSAR	10 Yrs Kumite Male 45+ kg	
	TUR006191	M	SAHIN MUSTAFA EGE	13 Yrs Kumite Male -40 kg	
	TUR04550	M	SAHIN OZKAN AYDIN	13 Yrs Kumite Male 55+ kg	
	TUR005022	M	SAMKAYA MAHIR EYMEN	12 Yrs Kumite Male -37 kg	
	TUR004966	M	SARICA ILKAN ILHAMI	13 Yrs Kumite Male -55 kg	
	TUR006220	M	SARIGUL ALI EFE	13 Yrs Kumite Male 55+ kg	
	TUR006259	M	SARITOPRAK MEHMET	12 Yrs Kata Individual Male	
	TUR006259	M	SARITOPRAK MEHMET	12-13 Yrs Kata Team Male	
	TUR006114	M	SAVAS MUHAMMET	11 Yrs Kumite Male -45 kg	
	TUR006039	M	SEFER IBRAHIM	10 Yrs Kumite Male -35 kg	
	TUR006289	M	SENGIL YUNUS EMRE	8-9 Yrs Kata Team Male	
	TUR006265	M	SIMSEK DOGUKAN	11 Yrs Kumite Male -40 kg	
	TUR006105	M	SONMEZ ISMAIL HAKKI	11 Yrs Kata Individual Male	
	TUR006105	M	SONMEZ ISMAIL HAKKI	11 Yrs Kumite Male -40 kg	
	TUR006177	M	SUR MUHAMMED MURAD	12 Yrs Kumite Male -52 kg	
	TUR005035	M	SUT MUHAMMED YASAR	12 Yrs Kumite Male -37 kg	
	TUR006229	M	TAC KAAAN AYAZ	8 Yrs Kata Individual Male	
	TUR04534	M	TAS ALPEREN	12 Yrs Kata Individual Male	
	TUR005675	M	TASAR AYAZ	12 Yrs Kumite Male -52 kg	
	TUR006157	M	TASKIN EREN	12 Yrs Kumite Male -42 kg	

30th Balkan Karate Championships for Children 202 ..

ENTRIES BY NATIONAL FEDERATION

As of 31 MAY 2026

Code	ID	Gender	Name	Event	Seeding
TUR	TUR006250	M	TAVACI YIGIT HASAN	10 Yrs Kata Individual Male	
	TUR005589	M	TEKE MUHAMMED BILAL	11 Yrs Kumite Male -35 kg	
	TUR006079	M	TEMEL HAMZA	10 Yrs Kumite Male 45+ kg	
	TUR005652	M	TEZCAN IBRAHIM SABRI	12 Yrs Kumite Male 52+ kg	
	TUR04543	M	TOKER HILMI METEHAN	13 Yrs Kumite Male -45 kg	
	TUR005545	M	TOPCU BARTU BEYHAN	11 Yrs Kata Individual Male	
	TUR006203	M	TOPDEMIR ASIL OMUR	13 Yrs Kumite Male -45 kg	
	TUR005647	M	TOSUN TUNA ALP	13 Yrs Kumite Male -55 kg	
	TUR006051	M	TUNC ALI TAHA	10 Yrs Kumite Male -40 kg	
	TUR006149	M	TURHAN MUHAMMED EMIN	12 Yrs Kumite Male -37 kg	
	TUR006028	M	TURKER DERIN	10 Yrs Kumite Male -30 kg	
	TUR005553	M	UCAK GOKALP	11 Yrs Kumite Male 50+ kg	
	TUR006273	M	ULUTURK NECATI YUCEL	10-11 Yrs Kata Team Male	
	TUR005059	M	UNAL UTKU TAHA	12 Yrs Kumite Male -52 kg	
	TUR006282	M	VURCAN EDIZ GOKHAN	8-9 Yrs Kata Team Male	
	TUR005668	M	YAGCI GOKBAY	12 Yrs Kata Individual Male	
	TUR006167	M	YALCIN YIGITHAN	12 Yrs Kumite Male -47 kg	
	TUR006148	M	YALIM EREN DORUK	12 Yrs Kumite Male -37 kg	
	TUR006131	M	YASAR METIN ALI	11 Yrs Kumite Male -50 kg	
	TUR006274	M	YILDIRIM KEREM ASLAN	10-11 Yrs Kata Team Male	
	TUR006251	M	YILDIZ MIRAC POYAZ	10 Yrs Kata Individual Male	
	TUR006169	M	YILDIZ TUGRA BEYTULLAH	12 Yrs Kumite Male -47 kg	
	TUR006118	M	YILMAZ ATA	11 Yrs Kumite Male -45 kg	
	TUR005106	M	YILMAZ KADIR MERT	10-11 Yrs Kata Team Male	
	TUR006077	M	YILMAZ PAMIR TANBEY	10 Yrs Kumite Male 45+ kg	
	TUR005539	M	YIRCALI OMER	10 Yrs Kata Individual Male	
	TUR006231	M	YOLCU ALI OSMAN	8 Yrs Kata Individual Male	
	TUR006269	M	YUKSEL ERTUGRUL	12-13 Yrs Kata Team Male	
	TUR006108	F	ACAR ZEHRA	11 Yrs Kumite Female -40 kg	
	TUR004931	F	AFSIN ECRIN YAREN	13 Yrs Kumite Female -39 kg	
	TUR005537	F	AKGUN AYZA	9 Yrs Kata Individual Female	
	TUR006134	F	AKKAN DERIN	11 Yrs Kumite Female 44+ kg	
	TUR006033	F	AKMAZ DERIN	10 Yrs Kumite Female -34 kg	
	TUR005666	F	AKPUNAR BEGUM	11 Yrs Kumite Female 44+ kg	
	TUR006035	F	AKSU CEMRE	10 Yrs Kumite Female -34 kg	
	TUR006123	F	AKTAS ZUMRA	11 Yrs Kumite Female -44 kg	
	TUR04492	F	ALABAS NISA	12 Yrs Kata Individual Female	
	TUR04492	F	ALABAS NISA	12-13 Yrs Kata Team Female	
	TUR006135	F	ALCICEK EMINE NISA	11 Yrs Kumite Female 44+ kg	
	TUR005091	F	ALEMDAR ELA BERAY	11 Yrs Kata Individual Female	
	TUR006228	F	ALTIN ALARA	8 Yrs Kata Individual Female	
	TUR006270	F	ALTINTAS ZEYNEP	10-11 Yrs Kata Team Female	
	TUR004939	F	ALTUN ULKU SURA	13 Yrs Kumite Female -49 kg	
	TUR006223	F	ASLAN ASMIN AYSE	8 Yrs Kata Individual Female	
	TUR04493	F	ASLAN GULSER	12 Yrs Kata Individual Female	
	TUR04493	F	ASLAN GULSER	12-13 Yrs Kata Team Female	
	TUR006173	F	ASLI IKRA	12 Yrs Kumite Female -50 kg	
	TUR006016	F	ATAGUL ZEYNEP	10 Yrs Kumite Female -30 kg	

30th Balkan Karate Championships for Children 202 ..

ENTRIES BY NATIONAL FEDERATION

As of 31 MAY 2026

Code	ID	Gender	Name	Event	Seeding
TUR	TUR006061	F	ATAK FATIMA	10 Yrs Kumite Female -40 kg	
	TUR006085	F	AYCICEK KUMSAL LINA	11 Yrs Kumite Female -32 kg	
	TUR005561	F	AYDIN BUGLEM DERIN	11 Yrs Kumite Female 44+ kg	
	TUR006179	F	AYDIN EZGI	12 Yrs Kumite Female 50+ kg	
	TUR006227	F	AYDIN ISIK	8 Yrs Kata Individual Female	
	TUR006227	F	AYDIN ISIK	8-9 Yrs Kata Team Female	
	TUR004950	F	AYKIN NUR BETUL	13 Yrs Kumite Female -49 kg	
	TUR006222	F	AYVENLI AYSE BETUL	8 Yrs Kata Individual Female	
	TUR005583	F	AZAK ELIF TUBA	11 Yrs Kumite Female -36 kg	
	TUR006238	F	BAGCI HIRA	9 Yrs Kata Individual Female	
	TUR006225	F	BALIKCI MERYEM NUR	8 Yrs Kata Individual Female	
	TUR006225	F	BALIKCI MERYEM NUR	8-9 Yrs Kata Team Female	
	TUR006218	F	BALTA MIRAY	13 Yrs Kumite Female 54+ kg	
	TUR005590	F	BESIKCI ELIF GOKCE	11 Yrs Kumite Female -32 kg	
	TUR006277	F	BOGA RAVZA	8-9 Yrs Kata Team Female	
	TUR006125	F	BUDAKER SIBEL	11 Yrs Kumite Female -44 kg	
	TUR006155	F	BUYUKBAYRAM HIRA NUR	12 Yrs Kumite Female -40 kg	
	TUR005644	F	CAKIR PERVIN	13 Yrs Kata Individual Female	
	TUR005644	F	CAKIR PERVIN	13 Yrs Kumite Female -54 kg	
	TUR006099	F	CALISKAN MELIKE SEYDA	11 Yrs Kumite Female -36 kg	
	TUR006211	F	CANKAYA MIRAY	13 Yrs Kumite Female -54 kg	
	TUR005540	F	CAPRAZ BELINAY	10 Yrs Kata Individual Female	
	TUR005540	F	CAPRAZ BELINAY	10-11 Yrs Kata Team Female	
	TUR006195	F	CARBAS ESLEM	13 Yrs Kumite Female -44 kg	
	TUR006058	F	CEBECI ALINA DENIZ	10 Yrs Kumite Female -40 kg	
	TUR006032	F	CECEN HILAL ESLEM	10 Yrs Kumite Female -34 kg	
	TUR006163	F	CELIK ADA TUANA	12 Yrs Kumite Female -45 kg	
	TUR006043	F	CEVIK NIDANUR	10 Yrs Kumite Female -37 kg	
	TUR006141	F	CIDACI MAHINUR	12 Yrs Kumite Female -35 kg	
	TUR006017	F	CIHAN ELIF ZUMRA	10 Yrs Kumite Female -30 kg	
	TUR006276	F	CIMEN EBRAR	8-9 Yrs Kata Team Female	
	TUR006112	F	CIN ECRIN	11 Yrs Kumite Female -40 kg	
	TUR004988	F	CIVAK FEYZA	12 Yrs Kumite Female -50 kg	
	TUR004973	F	COKU DILA	13 Yrs Kumite Female 54+ kg	
	TUR005620	F	COLAK HATICE SENA	13 Yrs Kumite Female -39 kg	
	TUR006278	F	DANLI ZEYNEP ESLEM	8-9 Yrs Kata Team Female	
	TUR03947	F	DARGIN AZRA MELIHA	13 Yrs Kata Individual Female	
	TUR03947	F	DARGIN AZRA MELIHA	12-13 Yrs Kata Team Female	
	TUR006207	F	DEGIRMENCI OZDE	13 Yrs Kumite Female -49 kg	
	TUR006240	F	DEMIR ASEL	9 Yrs Kata Individual Female	
	TUR006107	F	DEMIRCI MEDINE MERVE	11 Yrs Kumite Female -40 kg	
	TUR006204	F	DINDAR FIDAN	13 Yrs Kumite Female -49 kg	
	TUR004990	F	DIZDAR GOKCE DENIZ	12 Yrs Kumite Female 50+ kg	
	TUR006122	F	DOGAN AYSE MELEK	11 Yrs Kumite Female -44 kg	
	TUR006159	F	DONDAR DEFNE	12 Yrs Kumite Female -45 kg	
	TUR006048	F	DONMEZ ZULEYHA	10 Yrs Kumite Female -37 kg	
	TUR006076	F	DURAK DEFNE	10 Yrs Kumite Female 40+ kg	
	TUR006020	F	EKER MERYEM	10 Yrs Kumite Female -30 kg	

30th Balkan Karate Championships for Children 202 ..

ENTRIES BY NATIONAL FEDERATION

As of 31 MAY 2026

Code	ID	Gender	Name	Event	Seeding
TUR	TUR04586	F	EMRE ZEYNEP ERVA	13 Yrs Kumite Female -54 kg	
	TUR006144	F	ERKAN ZEYNEP SUMEYYE	12 Yrs Kumite Female -35 kg	
	TUR006279	F	ERKOL AHSEN SULTAN	8-9 Yrs Kata Team Female	
	TUR006181	F	EROL BEREN ADA GUZEL	12 Yrs Kumite Female 50+ kg	
	TUR006086	F	EZEL ELA NUR	11 Yrs Kumite Female -32 kg	
	TUR006170	F	EZEL EYLUL	12 Yrs Kumite Female -50 kg	
	TUR006057	F	GENC SELIN	10 Yrs Kumite Female -40 kg	
	TUR006239	F	GOCEN ELA GUL	9 Yrs Kata Individual Female	
	TUR006212	F	GOKSEL MIRAC	13 Yrs Kumite Female -54 kg	
	TUR006162	F	GORMEZ CEREN	12 Yrs Kumite Female -45 kg	
	TUR006194	F	GUL HUMEYRA	13 Yrs Kumite Female -44 kg	
	TUR005566	F	GULAL ILGIN	11 Yrs Kumite Female -40 kg	
	TUR04595	F	GULEN ECRIN	11 Yrs Kata Individual Female	
	TUR006216	F	GUMRUKCUOGLU MERYEM	13 Yrs Kumite Female 54+ kg	
	TUR006096	F	GUMUS BELINAY	11 Yrs Kumite Female -36 kg	
	TUR005591	F	GUNAY ELIF DURU	11 Yrs Kata Individual Female	
	TUR005591	F	GUNAY ELIF DURU	11 Yrs Kumite Female -32 kg	
	TUR005112	F	GUNDOGDU ZEYNEB NUR	12 Yrs Kata Individual Female	
	TUR006226	F	GUNDUZ BUSRA	8 Yrs Kata Individual Female	
	TUR04495	F	GUNDUZ RABIA ECEM	10-11 Yrs Kata Team Female	
	TUR006070	F	GUNER IRMAK	10 Yrs Kumite Female 40+ kg	
	TUR006248	F	GUNGOR AYZEN	10 Yrs Kata Individual Female	
	TUR006199	F	GUVENDI DURU	13 Yrs Kumite Female -44 kg	
	TUR006147	F	HAMURCU ZEYNEP	12 Yrs Kumite Female -35 kg	
	TUR006045	F	HELVACI ELIF	10 Yrs Kumite Female -37 kg	
	TUR006098	F	INCE TUANA	11 Yrs Kumite Female -36 kg	
	TUR005029	F	ISIK AYSE BETUL	12 Yrs Kumite Female -40 kg	
	TUR006249	F	ISIK ERVA NUR	10 Yrs Kata Individual Female	
	TUR006280	F	ITIL ELIF	8-9 Yrs Kata Team Female	
	TUR005651	F	IYISEN YAGMUR	12 Yrs Kumite Female 50+ kg	
	TUR006198	F	KABA AYSIMA	13 Yrs Kumite Female -44 kg	
	TUR004925	F	KAHVECIGIL ZEYNEP NAZ	13 Yrs Kata Individual Female	
	TUR006119	F	KAPLAN ELIF NUR	11 Yrs Kumite Female -44 kg	
	TUR005673	F	KAPLAN ZEYNEP	12 Yrs Kata Individual Female	
	TUR006100	F	KARA AYSE IREM	11 Yrs Kumite Female -36 kg	
	TUR004961	F	KARA OYKU	13 Yrs Kumite Female -54 kg	
	TUR006271	F	KARADAG ZEYNEP	10-11 Yrs Kata Team Female	
	TUR006133	F	KARAKAFA ELIF ECE	11 Yrs Kumite Female 44+ kg	
	TUR006178	F	KARAMAN SUMEYYE	12 Yrs Kumite Female 50+ kg	
	TUR005541	F	KAVAS BUGLEM	10-11 Yrs Kata Team Female	
	TUR005027	F	KAYA EYLUL CEREN	12 Yrs Kumite Female -40 kg	
	TUR005621	F	KILIC ISIL MARA	13 Yrs Kumite Female -39 kg	
	TUR006019	F	KIR ZEYNEP RUKIYE	10 Yrs Kumite Female -30 kg	
	TUR006047	F	KIRCAALI SURU	10 Yrs Kumite Female -37 kg	
	TUR005103	F	KOCAK DEFNE	10 Yrs Kata Individual Female	
	TUR005622	F	KOCAKAPLAN ZEHRA	13 Yrs Kumite Female -39 kg	
	TUR006187	F	KOCYIGIT FATMA BETUL	13 Yrs Kumite Female -39 kg	
	TUR04010	F	KOZAK FATMA NUR	12 Yrs Kata Individual Female	

30th Balkan Karate Championships for Children 202 ..

ENTRIES BY NATIONAL FEDERATION

As of 31 MAY 2026

Code	ID	Gender	Name	Event	Seeding
TUR	TUR04010	F	KOZAK FATMA NUR	12-13 Yrs Kata Team Female	
	TUR006146	F	KURTOGLU MILA	12 Yrs Kumite Female -35 kg	
	TUR006217	F	KUS BEREN	13 Yrs Kumite Female 54+ kg	
	TUR04058	F	KUTLUG SADIYAH	12-13 Yrs Kata Team Female	
	TUR005688	F	KUZLU ECRIN MELEK	12 Yrs Kumite Female -40 kg	
	TUR006029	F	LAFCI SINA	10 Yrs Kumite Female -34 kg	
	TUR006121	F	MANTAR EDA	11 Yrs Kumite Female -44 kg	
	TUR006145	F	MERT ZUMRA	12 Yrs Kumite Female -35 kg	
	TUR006253	F	MUTLUOGLU RABIA	11 Yrs Kata Individual Female	
		F	ODEMIS ELIF ULKU	12 Yrs Kumite Female -35 kg	
	TUR006109	F	ONALAN BERCEM	11 Yrs Kumite Female -40 kg	
	TUR006056	F	OREK HIRANUR	10 Yrs Kumite Female -40 kg	
	TUR005038	F	OREN CEYDANUR MIRA	12 Yrs Kumite Female -50 kg	
	TUR006021	F	ORUCOGLU RABIA	10 Yrs Kumite Female -30 kg	
	TUR006261	F	OZ ECRIN	13 Yrs Kata Individual Female	
	TUR006060	F	OZCALISIR MELISA OZGE	10 Yrs Kumite Female -40 kg	
	TUR006143	F	OZCAN ELIFNUR	12 Yrs Kumite Female -35 kg	
	TUR006084	F	OZDEMIR SEMA NUR	11 Yrs Kumite Female -32 kg	
	TUR006087	F	OZKAN ELIF ECE	11 Yrs Kumite Female -32 kg	
	TUR005628	F	OZKAN TUGSEM	13 Yrs Kumite Female -44 kg	
	TUR004926	F	OZTEKIN MERYEM	13 Yrs Kata Individual Female	
	TUR006110	F	OZTURK INCI	11 Yrs Kumite Female -40 kg	
	TUR006072	F	OZTURK MEYRA	10 Yrs Kumite Female 40+ kg	
	TUR006219	F	SADAN HAYRUNNISA	13 Yrs Kumite Female 54+ kg	
	TUR006224	F	SAHIN SINEM ECE	8 Yrs Kata Individual Female	
	TUR04506	F	SAKINAK PERIHAN NAZ	13 Yrs Kumite Female 54+ kg	
	TUR006272	F	SANDAL ZEYNEP SARE	10-11 Yrs Kata Team Female	
	TUR005099	F	SARAYDAR ESLEM MEVA	10 Yrs Kata Individual Female	
	TUR005099	F	SARAYDAR ESLEM MEVA	10 Yrs Kumite Female -37 kg	
	TUR005099	F	SARAYDAR ESLEM MEVA	10-11 Yrs Kata Team Female	
	TUR006046	F	SARI ZEYNEB	10 Yrs Kumite Female -37 kg	
	TUR006267	F	SAVAS AYSE SEVDE	12-13 Yrs Kata Team Female	
	TUR005550	F	SEMERCİ ESMA	11 Yrs Kata Individual Female	
	TUR006059	F	SEN BELINAY	10 Yrs Kumite Female -40 kg	
	TUR006196	F	SENEL YAGMUR MUNIRE	13 Yrs Kumite Female -44 kg	
	TUR006015	F	SENGOZ EDA	10 Yrs Kumite Female -30 kg	
	TUR005618	F	SIMSEK NESIBENUR	13 Yrs Kumite Female -39 kg	
	TUR006160	F	SIR KEVSER	12 Yrs Kumite Female -45 kg	
	TUR006075	F	SIVRI YAGMUR SILA	10 Yrs Kumite Female 40+ kg	
	TUR006034	F	SUBASI ZEYNEP	10 Yrs Kumite Female -34 kg	
	TUR005680	F	SUMBUL ELISA	12 Yrs Kumite Female -50 kg	
	TUR03945	F	TANHAN MERYEM GOKCE	12-13 Yrs Kata Team Female	
	TUR04540	F	TAS MIRAC EYLUL	13 Yrs Kumite Female -54 kg	
	TUR006257	F	TASYAR MERYEM RUVEYDA	12 Yrs Kata Individual Female	
	TUR006236	F	TERZI FATMA AZRA	9 Yrs Kata Individual Female	
	TUR006180	F	TOKLU MIRAY NUR	12 Yrs Kumite Female 50+ kg	
	TUR006074	F	TOMAK ZEYNEP OYKU	10 Yrs Kumite Female 40+ kg	
	TUR006044	F	TOPCU ESILA	10 Yrs Kumite Female -37 kg	

30th Balkan Karate Championships for Children 202 ..

ENTRIES BY NATIONAL FEDERATION

As of 31 MAY 2026

Code	ID	Gender	Name	Event	Seeding
TUR	TUR006260	F	TORUN ZEYNEP HIRA	13 Yrs Kata Individual Female	
	TUR004962	F	TOSUN SENA	13 Yrs Kumite Female 54+ kg	
	TUR006258	F	TURAN ASYA MASAL	12 Yrs Kata Individual Female	
	TUR006073	F	TURAN ELIF SU	10 Yrs Kumite Female 40+ kg	
	TUR006235	F	TURK CEREN	9 Yrs Kata Individual Female	
	TUR004993	F	TURKMEN HILAL	12-13 Yrs Kata Team Female	
	TUR005039	F	TURKMENOGLU AMELYA	12 Yrs Kumite Female -45 kg	
	TUR006018	F	TURNAZ RUKEN ZEYNEP	10 Yrs Kumite Female -30 kg	
	TUR006101	F	TUTUS FIKRIYE YUSRA	11 Yrs Kumite Female -36 kg	
	TUR005560	F	ULUBEY AZRA	11 Yrs Kumite Female 44+ kg	
	TUR004992	F	URAN MELIS	12 Yrs Kumite Female 50+ kg	
	TUR006161	F	URAY RABIASU	12 Yrs Kumite Female -45 kg	
	TUR005101	F	USTA AYSE HUSNA	10 Yrs Kata Individual Female	
	TUR005090	F	UZUNESER MIHRINUR	11 Yrs Kata Individual Female	
	TUR005116	F	UZUNESER MIHRISAH	13 Yrs Kata Individual Female	
	TUR006031	F	VURAL EFLIN ERVA	10 Yrs Kumite Female -34 kg	
	TUR005104	F	YALCINKAYA RABIA INCI	10 Yrs Kata Individual Female	
	TUR006071	F	YALNIZOGLU RABIA TUGBA	10 Yrs Kumite Female 40+ kg	
	TUR005044	F	YAMAN SUMEYRA	12 Yrs Kumite Female -45 kg	
	TUR006153	F	YASAR ZEYNEP	12 Yrs Kumite Female -40 kg	
	TUR006095	F	YAVUZ AYSEGUL	11 Yrs Kumite Female -32 kg	
	TUR006062	F	YAVUZ BEREN	10 Yrs Kumite Female -40 kg	
	TUR006154	F	YAVUZ ZEYNEP	12 Yrs Kumite Female -40 kg	
	TUR006197	F	YAVUZ ZUMRA	13 Yrs Kumite Female -44 kg	
	TUR006111	F	YEGEN DEFNE ADA	11 Yrs Kumite Female -40 kg	
	TUR006030	F	YETKIN ELIF	10 Yrs Kumite Female -34 kg	
	TUR006097	F	YILDIRIM HIRANUR	11 Yrs Kumite Female -36 kg	
	TUR006171	F	YILDIRIM ZUBEYDE BEYZA	12 Yrs Kumite Female -50 kg	
	TUR006120	F	YILDIZ ADA SU	11 Yrs Kumite Female -44 kg	
	TUR006237	F	YILDIZ OZNUR HATICE	9 Yrs Kata Individual Female	
	TUR04483	F	YILDIZ SUMEYRA	13 Yrs Kumite Female -49 kg	
	TUR006124	F	YILMAZ AFRA	11 Yrs Kumite Female -44 kg	
	TUR005529	F	YILMAZ BERRA	13 Yrs Kumite Female -54 kg	
	TUR005687	F	YILMAZ BEYZANUR	12 Yrs Kumite Female -40 kg	
	TUR006132	F	YILMAZ NILDA OYKU	11 Yrs Kumite Female 44+ kg	
	TUR006205	F	YILMAZ ZEYNEP	13 Yrs Kumite Female -49 kg	
	TUR005551	F	YORGUN MASAL	11 Yrs Kata Individual Female	
	TUR005551	F	YORGUN MASAL	10-11 Yrs Kata Team Female	
	TUR006172	F	YUMRU BETUL ABIDE	12 Yrs Kumite Female -50 kg	
	TUR006206	F	YURDUSEVEN ALARA ILGIN	13 Yrs Kumite Female -49 kg	
	TUR006186	F	YUSUF NAILE	13 Yrs Kumite Female -39 kg	

A world map graphic rendered in a blue dot-matrix style, centered in the background of the page. The map is semi-transparent, allowing the underlying abstract patterns to be seen through it.

STATISTICS

30th Balkan Karate Championships for Children 2026 - Istanbul

Statistics

Participating Countries: 13

	Competitors	Entries
Female	805	859
Male	763	805
Total	1568	1664

Entries per Category	Entries	Teams
10 Yrs Kata Individual Female	40	-
10 Yrs Kata Individual Male	34	-
10 Yrs Kumite Female -30 kg	36	-
10 Yrs Kumite Female -34 kg	27	-
10 Yrs Kumite Female -37 kg	21	-
10 Yrs Kumite Female -40 kg	16	-
10 Yrs Kumite Female 40+ kg	21	-
10 Yrs Kumite Male -30 kg	28	-
10 Yrs Kumite Male -35 kg	30	-
10 Yrs Kumite Male -40 kg	23	-
10 Yrs Kumite Male -45 kg	24	-
10 Yrs Kumite Male 45+ kg	18	-
10-11 Yrs Kata Team Female	-	13
10-11 Yrs Kata Team Male	-	10
11 Yrs Kata Individual Female	44	-
11 Yrs Kata Individual Male	38	-
11 Yrs Kumite Female -32 kg	28	-
11 Yrs Kumite Female -36 kg	29	-
11 Yrs Kumite Female -40 kg	34	-
11 Yrs Kumite Female -44 kg	19	-
11 Yrs Kumite Female 44+ kg	29	-
11 Yrs Kumite Male -35 kg	33	-
11 Yrs Kumite Male -40 kg	38	-
11 Yrs Kumite Male -45 kg	28	-
11 Yrs Kumite Male -50 kg	18	-
11 Yrs Kumite Male 50+ kg	20	-
12 Yrs Kata Individual Female	38	-
12 Yrs Kata Individual Male	39	-
12 Yrs Kumite Female -35 kg	30	-
12 Yrs Kumite Female -40 kg	37	-
12 Yrs Kumite Female -45 kg	39	-

30th Balkan Karate Championships for Children 2026 - Istanbul

Statistics

12 Yrs Kumite Female -50 kg	32	-
12 Yrs Kumite Female 50+ kg	29	-
12 Yrs Kumite Male -37 kg	37	-
12 Yrs Kumite Male -42 kg	32	-
12 Yrs Kumite Male -47 kg	27	-
12 Yrs Kumite Male -52 kg	25	-
12 Yrs Kumite Male 52+ kg	33	-
12-13 Yrs Kata Team Female	-	9
12-13 Yrs Kata Team Male	-	6
13 Yrs Kata Individual Female	44	-
13 Yrs Kata Individual Male	39	-
13 Yrs Kumite Female -39 kg	27	-
13 Yrs Kumite Female -44 kg	38	-
13 Yrs Kumite Female -49 kg	39	-
13 Yrs Kumite Female -54 kg	36	-
13 Yrs Kumite Female 54+ kg	36	-
13 Yrs Kumite Male -40 kg	27	-
13 Yrs Kumite Male -45 kg	34	-
13 Yrs Kumite Male -50 kg	30	-
13 Yrs Kumite Male -55 kg	28	-
13 Yrs Kumite Male 55+ kg	36	-
8 Yrs Kata Individual Female	27	-
8 Yrs Kata Individual Male	26	-
8-9 Yrs Kata Team Female	-	9
8-9 Yrs Kata Team Male	-	8
9 Yrs Kata Individual Female	32	-
9 Yrs Kata Individual Male	36	-
Totals:	1609	55

10-11 Yrs Kata Team Female

30th Balkan Karate Championships for Children 2026 - Istanbul, Basaksehir Spor Hall, Kayabaşı, TINAZTEPE CADDESİ NO:6, 34494 Başakşehir, İstanbul, TUR2026-05-31

Tatami

3 09:00

Pool

1/1

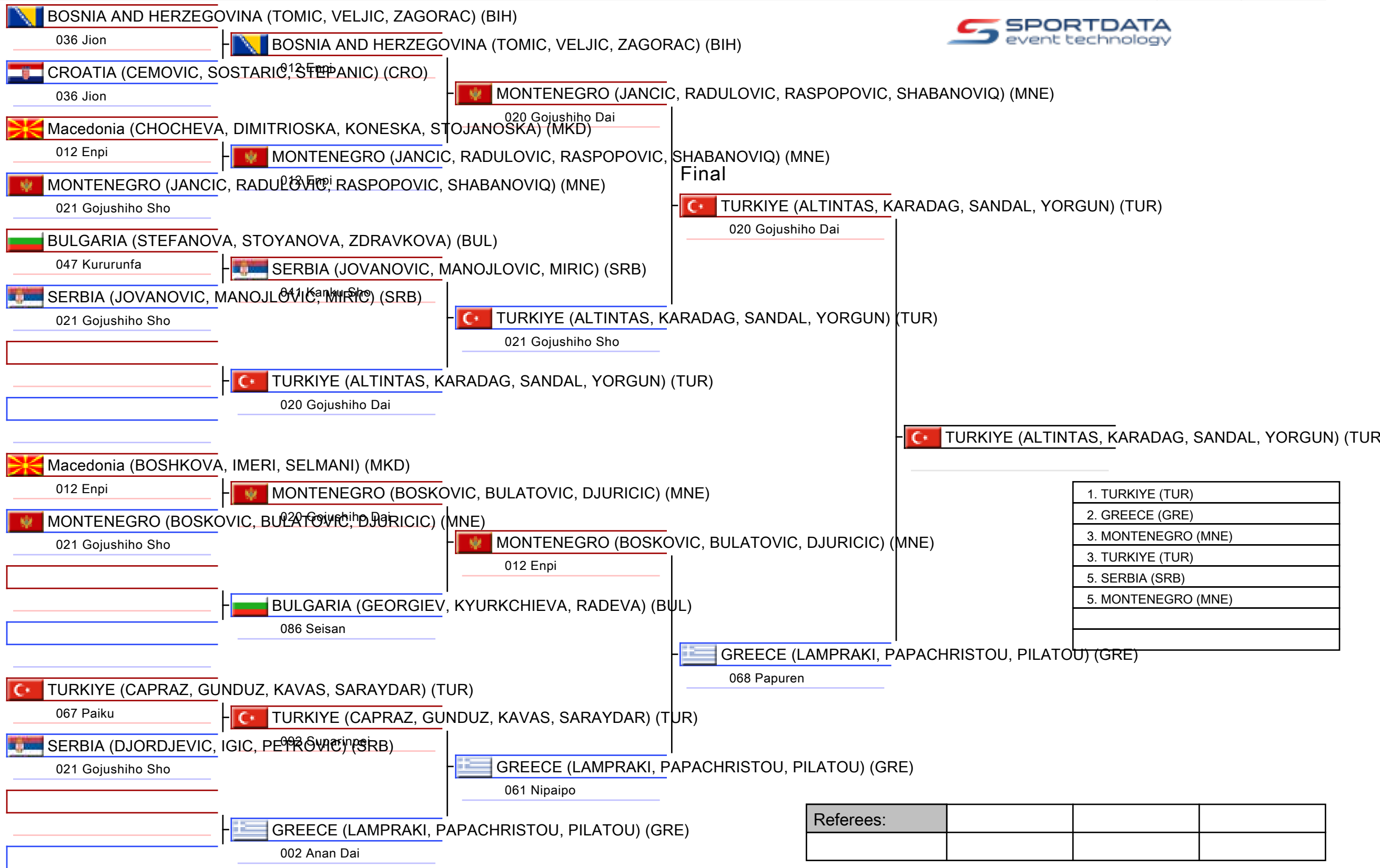

10-11 Yrs Kata Team Female

30th Balkan Karate Championships for Children 2026 - Istanbul

2026-05-31

Tatami
3 09:55

Pool
1

(c)sportdata GmbH & Co KG 2000-2026 (2026-05-31 14:44) v 12.2.0 build 1 (2026-05-24 19:07 CET) License: Lazar Piper SRB (expire 2027-01-23)

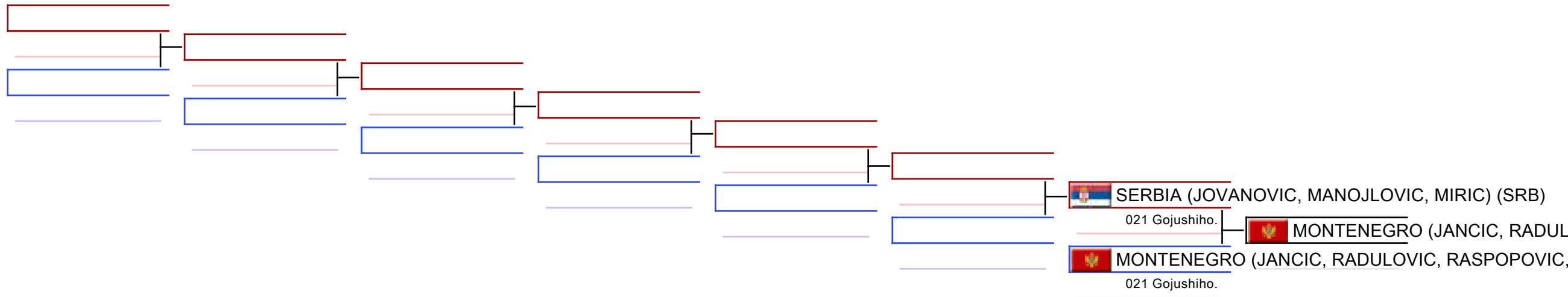

REPECHAGE: (1)

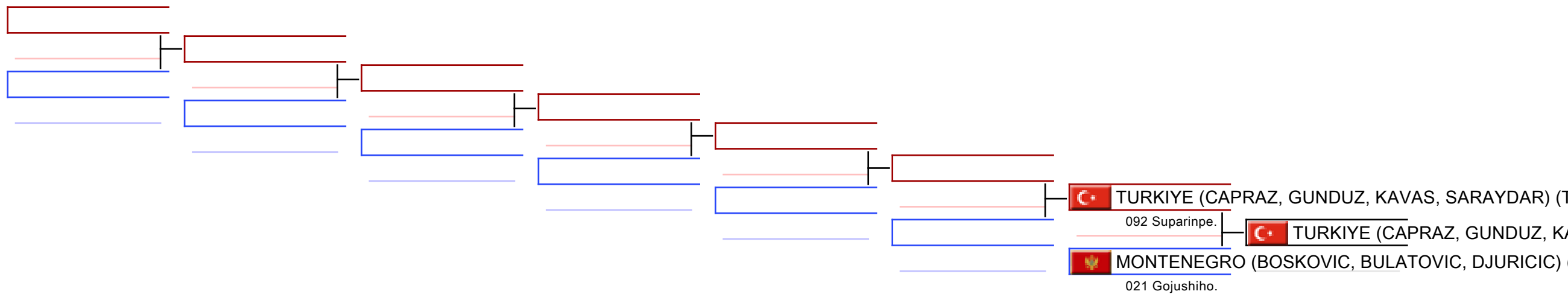

Referees:							
-----------	--	--	--	--	--	--	--

10-11 Yrs Kata Team Male

30th Balkan Karate Championships for Children 2026 - Istanbul, Basaksehir Spor Hall, Kayabaşı, TINAZTEPE CADDESİ NO:6, 34494 Başakşehir, İstanbul, TUR2026-05-31

Tatami
4 09:00

Pool
1/1

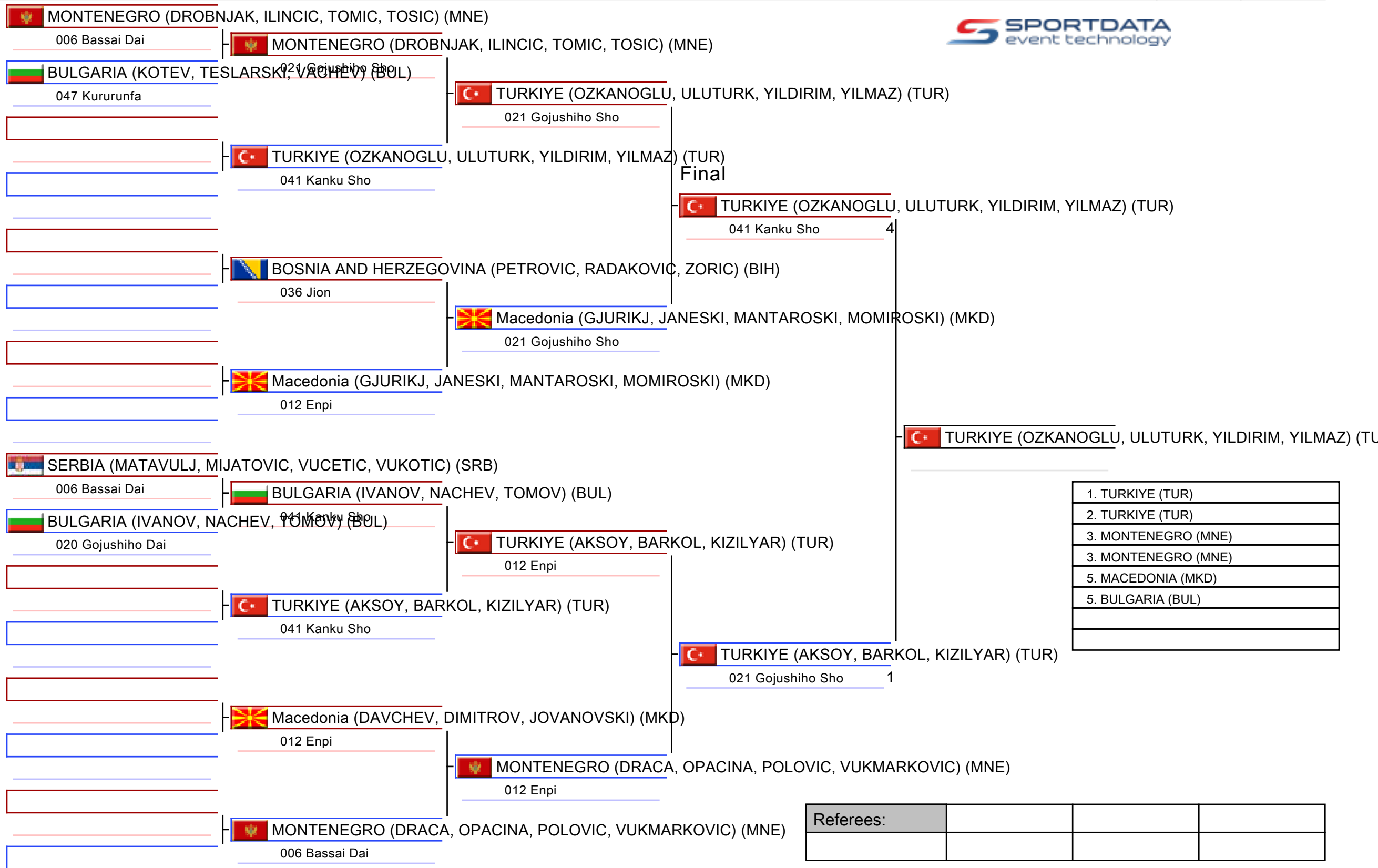

1. TURKIYE (TUR)
2. TURKIYE (TUR)
3. MONTENEGRO (MNE)
3. MONTENEGRO (MNE)
5. MACEDONIA (MKD)
5. BULGARIA (BUL)

10-11 Yrs Kata Team Male

30th Balkan Karate Championships for Children 2026 - Istanbul

2026-05-31

Tatami
4 09:40

Pool
1

(c)sportdata GmbH & Co KG 2000-2026 (2026-05-31 14:44) v 12.2.0 build 1 (2026-05-24 19:07 CET) License: Lazar Piper SRB (expire 2027-01-23)

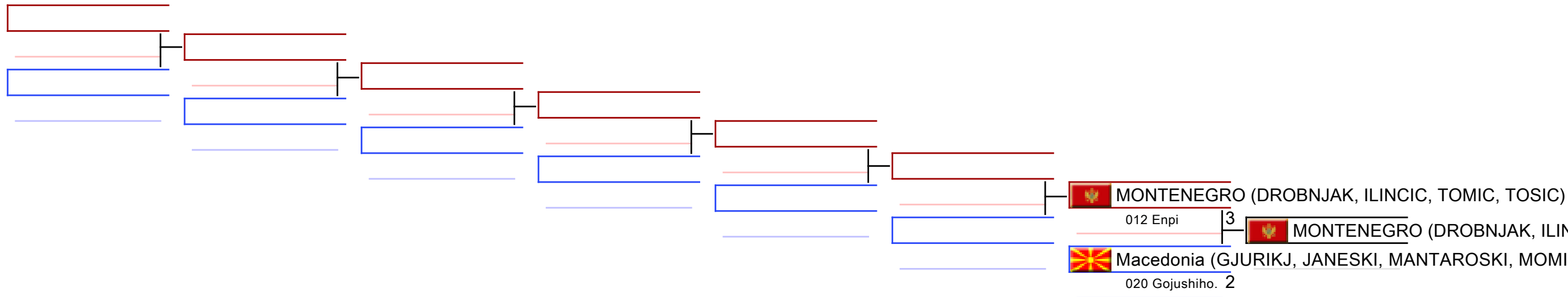

REPECHAGE: (1)

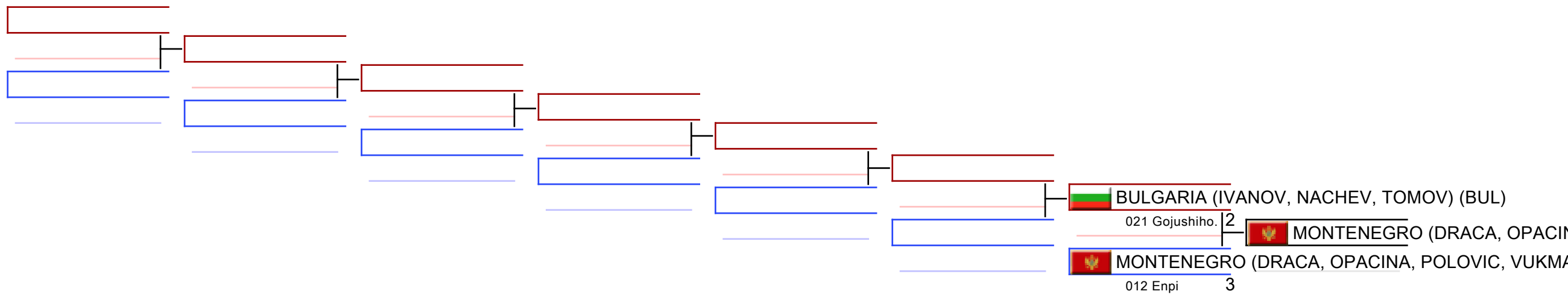

Referees:							
-----------	--	--	--	--	--	--	--

10 Yrs Kata Individual Female

30th Balkan Karate Championships for Children 2026 - Istanbul, Basaksehir Spor Hall, Kayabaşı, TINAZTEPE CADDESİ NO:6, 34494 Başakşehir, İstanbul, TUR2026-05-30

Tatami

3 10:50

Pool

1/2

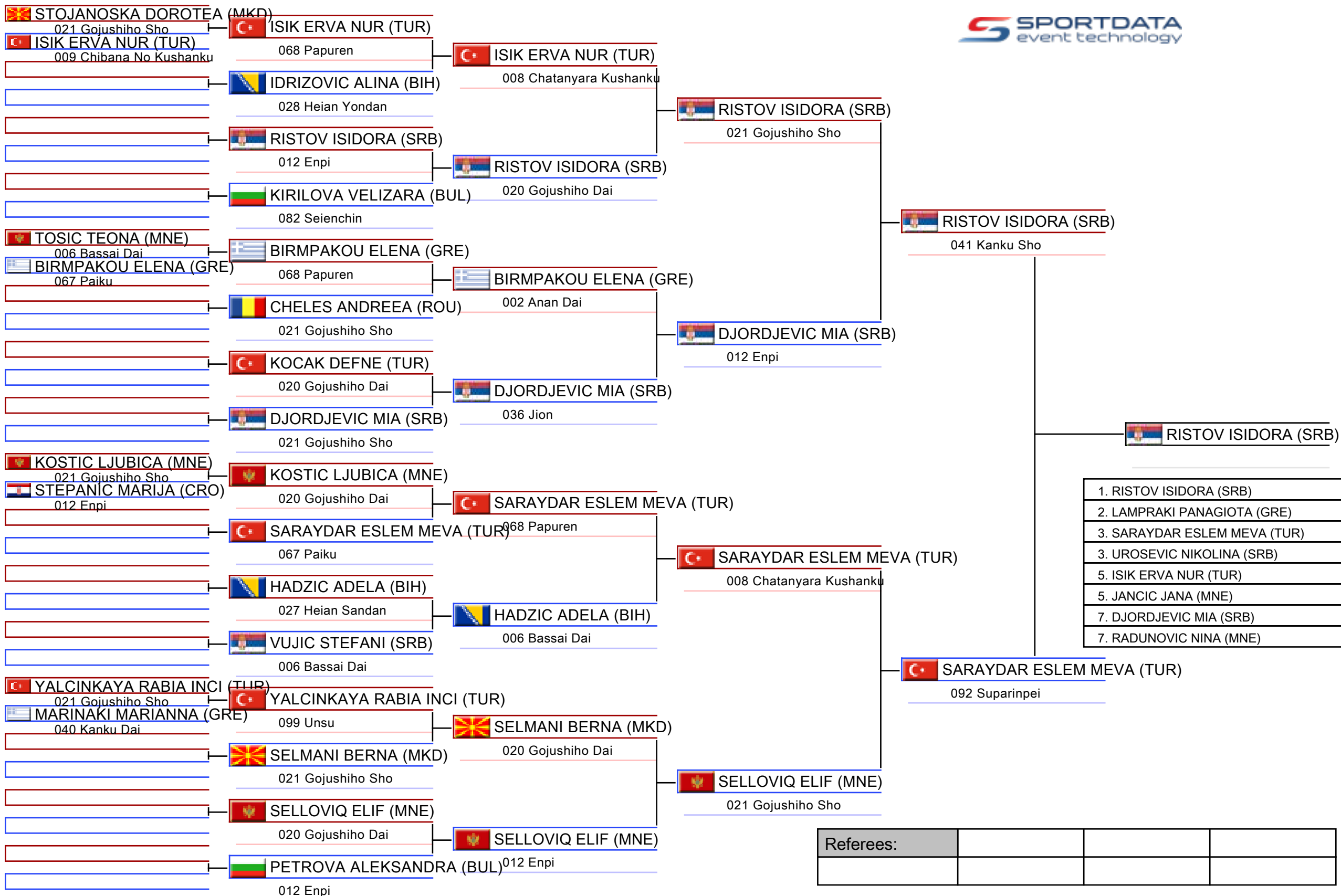

- | |
|------------------------------|
| 1. RISTOV ISIDORA (SRB) |
| 2. LAMPRAKI PANAGIOTA (GRE) |
| 3. SARAYDAR ESLEM MEVA (TUR) |
| 3. UROSEVIC NIKOLINA (SRB) |
| 5. ISIK ERVA NUR (TUR) |
| 5. JANCIC JANA (MNE) |
| 7. DJORDJEVIC MIA (SRB) |
| 7. RADUNOVIC NINA (MNE) |

Referees:			

10 Yrs Kata Individual Female

30th Balkan Karate Championships for Children 2026 - Istanbul, Basaksehir Spor Hall, Kayabaşı, TINAZTEPE CADDESİ NO:6, 34494 Başakşehir, İstanbul, TUR2026-05-30

Tatami

4 10:50

Pool

2/2

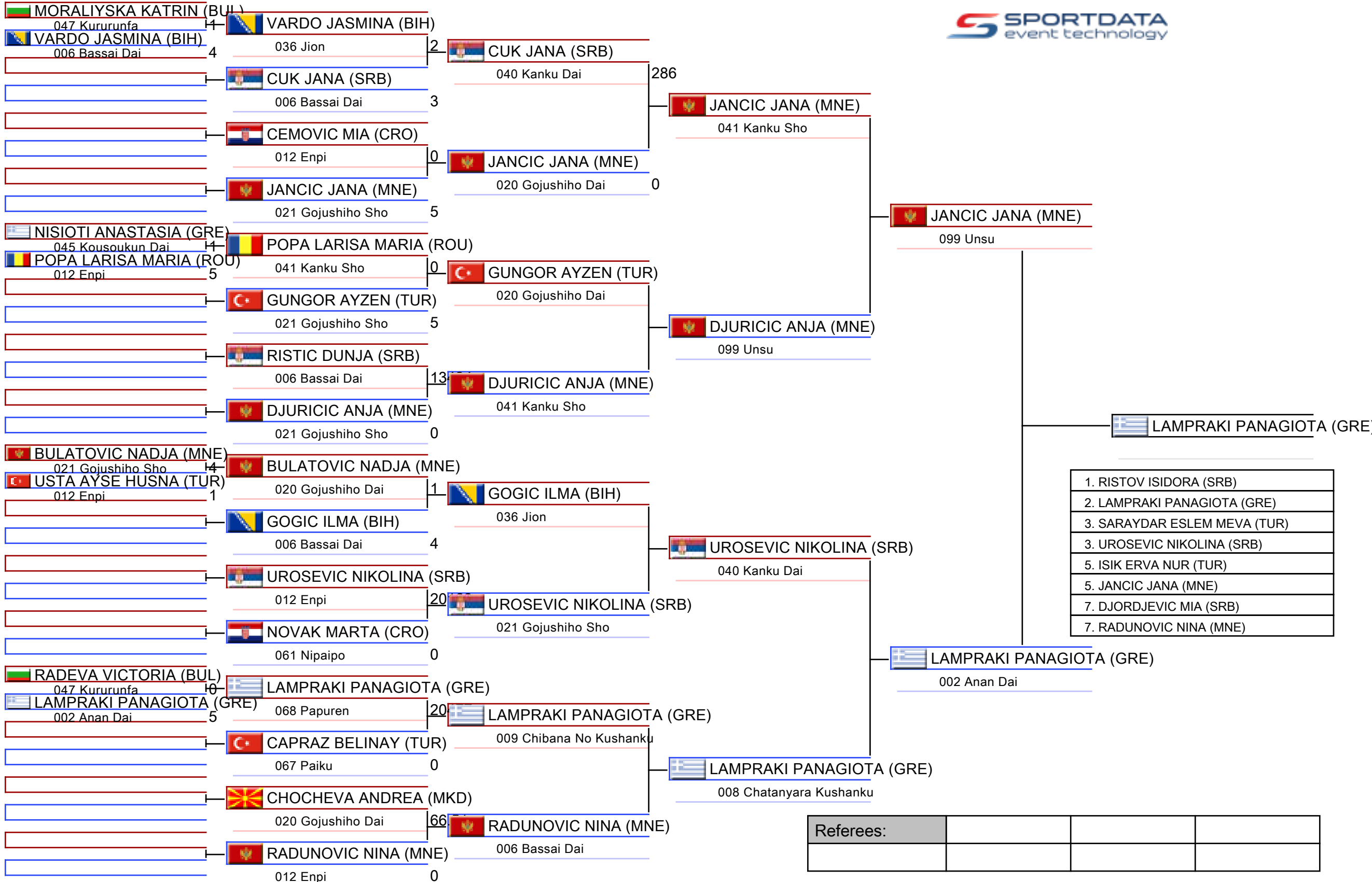

- | |
|------------------------------|
| 1. RISTOV ISIDORA (SRB) |
| 2. LAMPRAKI PANAGIOTA (GRE) |
| 3. SARAYDAR ESLEM MEVA (TUR) |
| 3. UROSEVIC NIKOLINA (SRB) |
| 5. ISIK ERVA NUR (TUR) |
| 5. JANCIC JANA (MNE) |
| 7. DJORDJEVIC MIA (SRB) |
| 7. RADUNOVIC NINA (MNE) |

Referees:			

Pool winner-10 Yrs Kata Individual Female

30th Balkan Karate Championships for Children 2026 - Istanbul, Basaksehir Spor Hall, Kayabaşı, TINAZTEPE CADDESİ NO:6, 34494 Başakşehir, İstanbul, TUR

Tatami

Pool
1/1

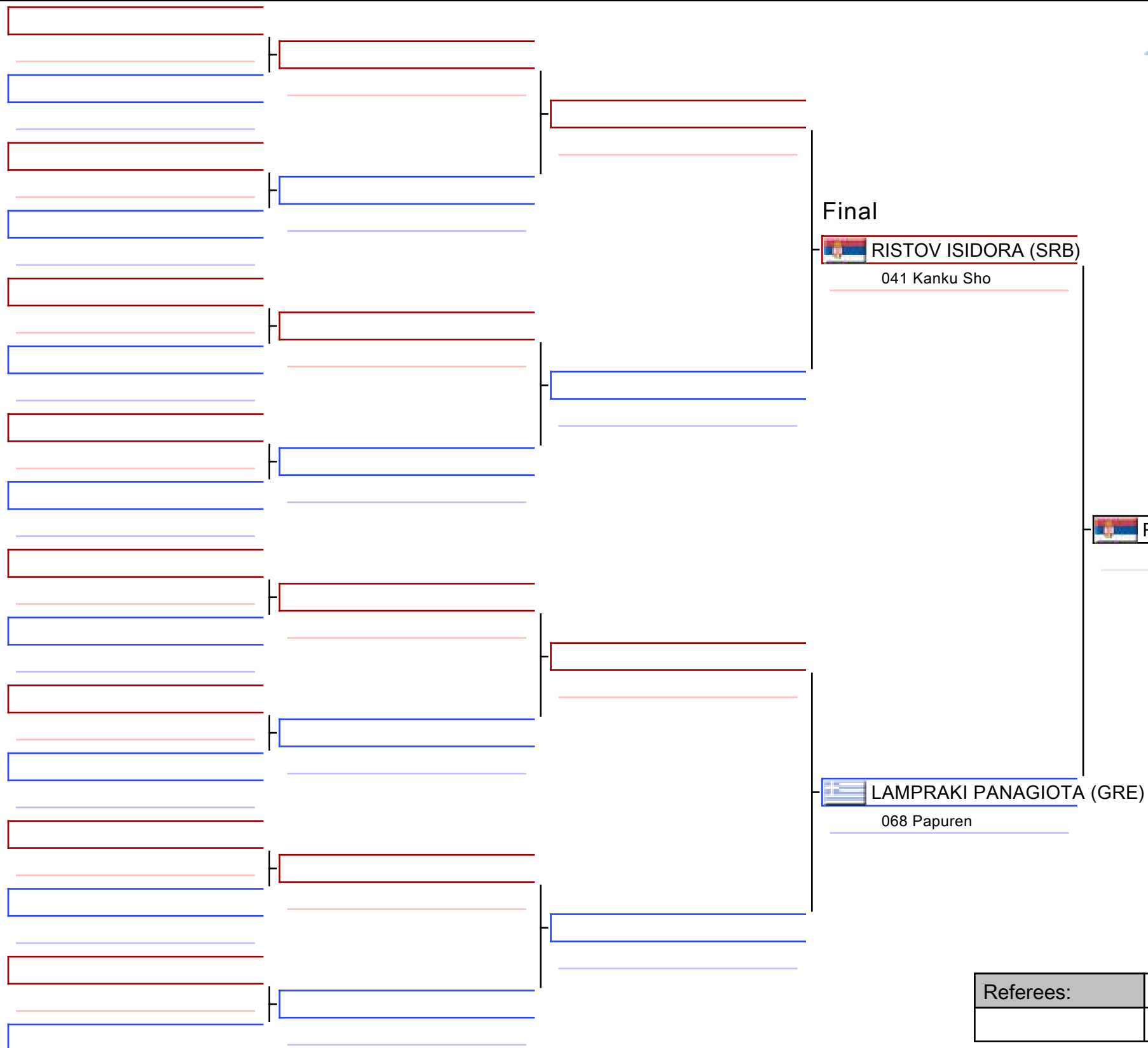

Final

 RISTOV ISIDORA (SRB)
041 Kanku Sho

 RISTOV ISIDORA (SRB)

 LAMPRAKI PANAGIOTA (GRE)
068 Papuren

1. RISTOV ISIDORA (SRB)
2. LAMPRAKI PANAGIOTA (GRE)
3. SARAYDAR ESLEM MEVA (TUR)
3. UROSEVIC NIKOLINA (SRB)
5. ISIK ERVA NUR (TUR)
5. JANCIC JANA (MNE)
7. DJORDJEVIC MIA (SRB)
7. RADUNOVIC NINA (MNE)

Referees:			

10 Yrs Kata Individual Female

30th Balkan Karate Championships for Children 2026 - Istanbul

2026-05-30

Tatami
4 12:25

Pool
1,2

(c)sportdata GmbH & Co KG 2000-2026 (2026-05-31 14:44) v 12.2.0 build 1 (2026-05-24 19:07 CET) License: Lazar Piper SRB (expire 2027-01-23)

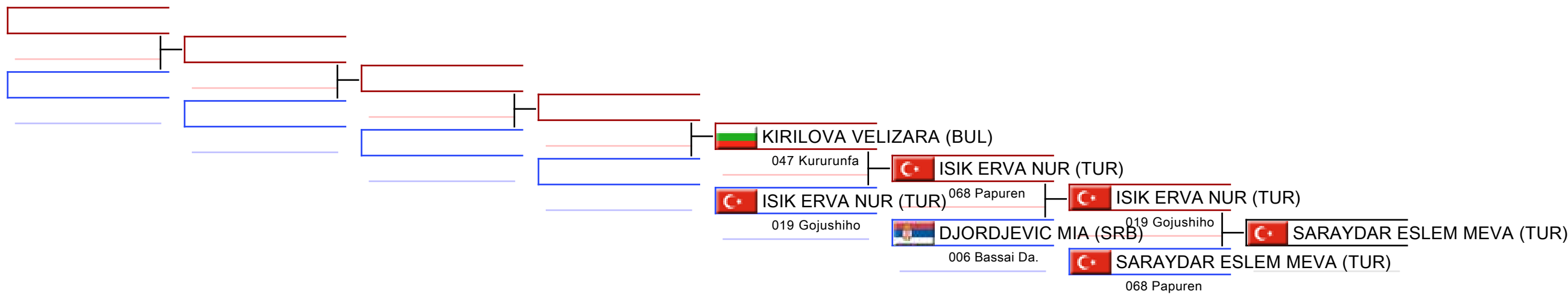

REPECHAGE: (1,2)

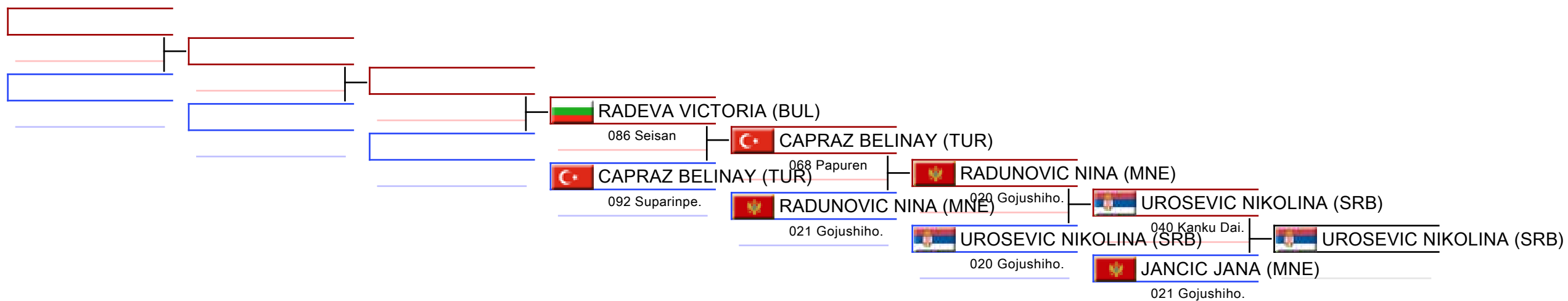

Referees:							
-----------	--	--	--	--	--	--	--

10 Yrs Kata Individual Male

30th Balkan Karate Championships for Children 2026 - Istanbul, Basaksehir Spor Hall, Kayabaşı, TINAZTEPE CADDESİ NO:6, 34494 Başakşehir, İstanbul, TUR2026-05-29

Tatami

4 09:00

Pool

1/2

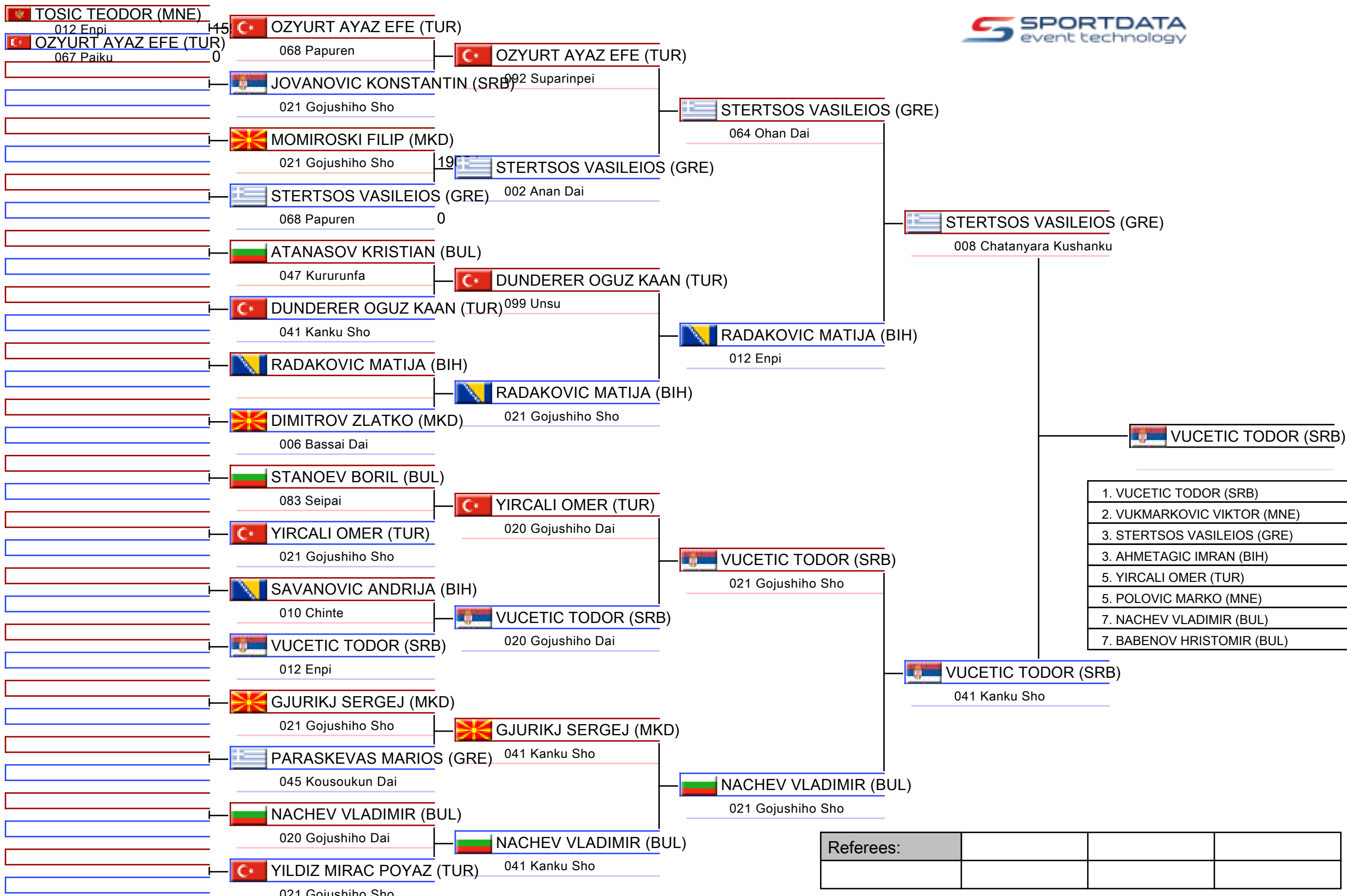

1. VUCETIC TODOR (SRB)
2. VUKMARKOVIC VIKTOR (MNE)
3. STERTSOS VASILEIOS (GRE)
3. AHMETAGIC IMRAN (BIH)
5. YIRCALI OMER (TUR)
5. POLOVIC MARKO (MNE)
7. NACHEV VLADIMIR (BUL)
7. BABENOV HRISTOMIR (BUL)

Referees:			

Pool winner-10 Yrs Kata Individual Male

30th Balkan Karate Championships for Children 2026 - Istanbul, Basaksehir Spor Hall, Kayabaşı, TINAZTEPE CADDESİ NO:6, 34494 Başakşehir, İstanbul, TUR

Tatami

Pool
1/1

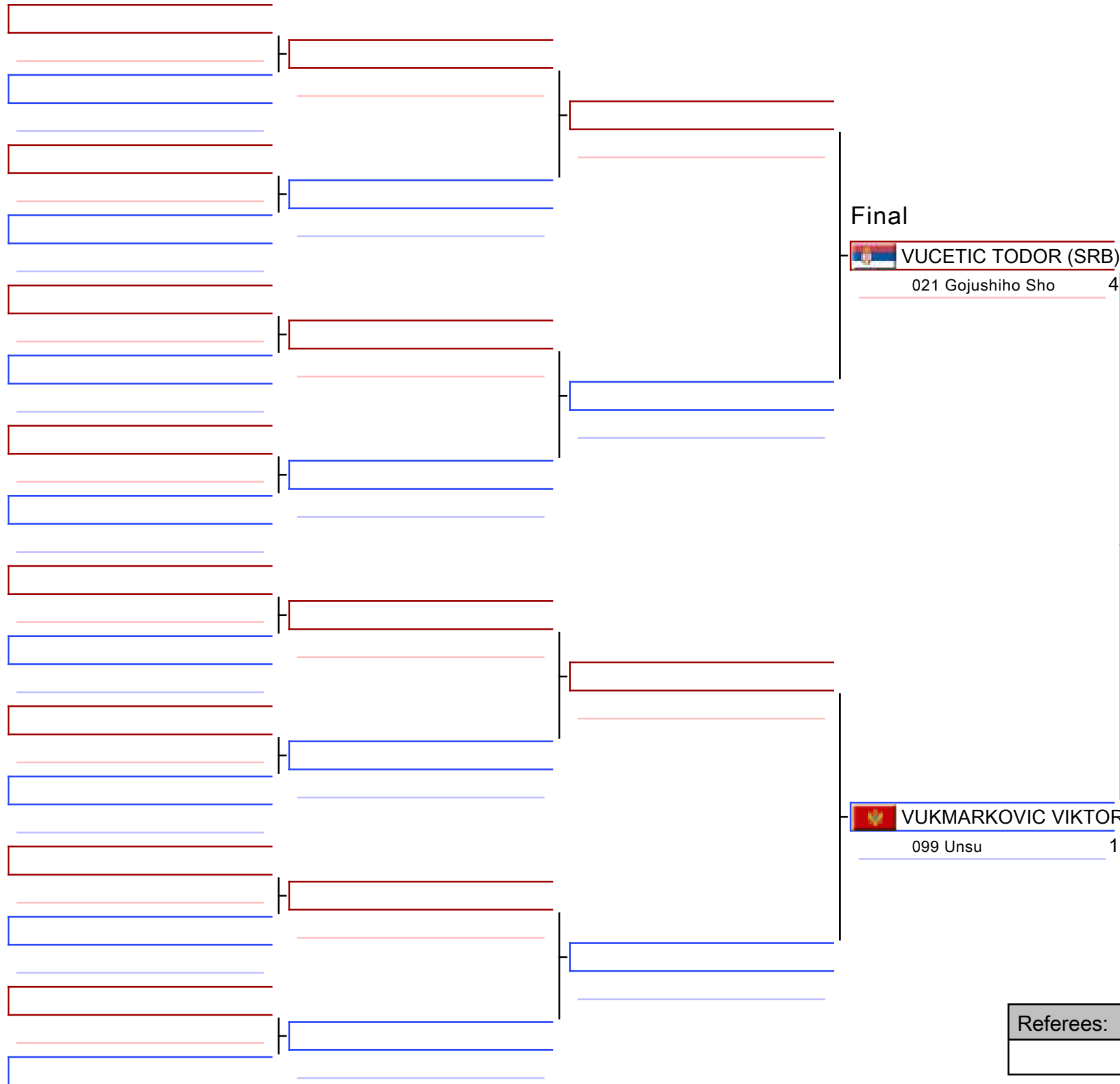

Final

VUCETIC TODOR (SRB)
021 Gojushiho Sho 4

VUCETIC TODOR (SRB)

VUKMARKOVIC VIKTOR (MNE)
099 Unsu 1

1. VUCETIC TODOR (SRB)
2. VUKMARKOVIC VIKTOR (MNE)
3. STERTSOS VASILEIOS (GRE)
3. AHMETAGIC IMRAN (BIH)
5. YIRCALI OMER (TUR)
5. POLOVIC MARKO (MNE)
7. NACHEV VLADIMIR (BUL)
7. BABENOV HRISTOMIR (BUL)

Referees:			

10 Yrs Kata Individual Male

30th Balkan Karate Championships for Children 2026 - Istanbul

2026-05-29

Tatami

4 11:40

Pool

1,2

(c)sportdata GmbH & Co KG 2000-2026 (2026-05-31 14:44) v 12.2.0 build 1 (2026-05-24 19:07 CET) License: Lazar Piper SRB (expire 2027-01-23)

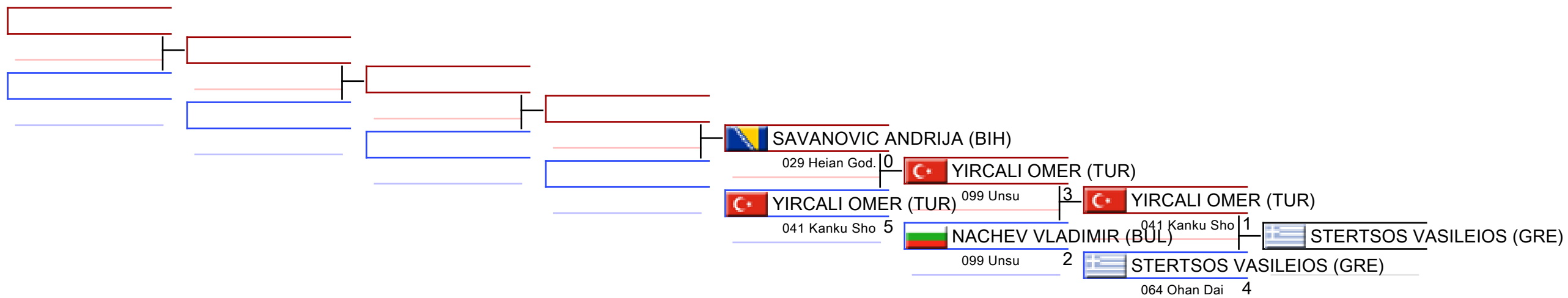

REPECHAGE: (1,2)

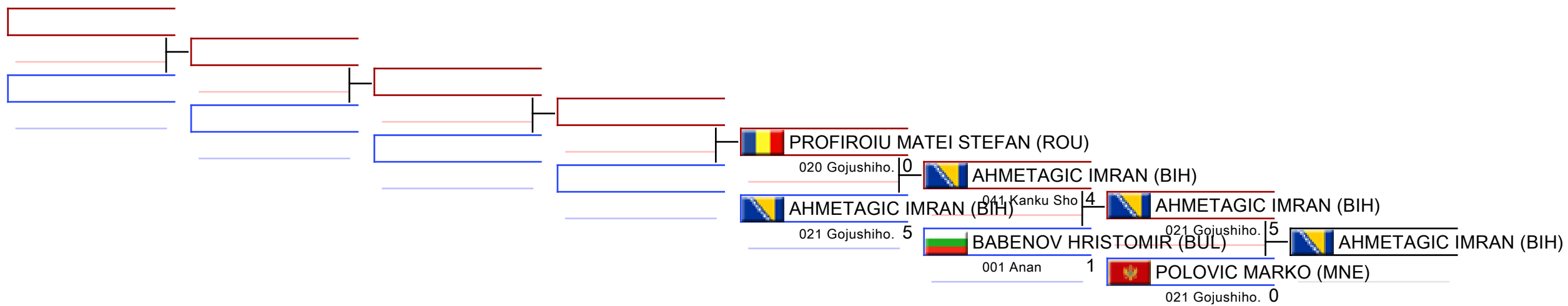

Referees:							
-----------	--	--	--	--	--	--	--

10 Yrs Kumite Female -30 kg

30th Balkan Karate Championships for Children 2026 - Istanbul, Basaksehir Spor Hall, Kayabaşı, TINAZTEPE CADDESİ NO:6, 34494 Başakşehir, İstanbul, TUR2026-05-29

Tatami

3 12:50

Pool

1/2

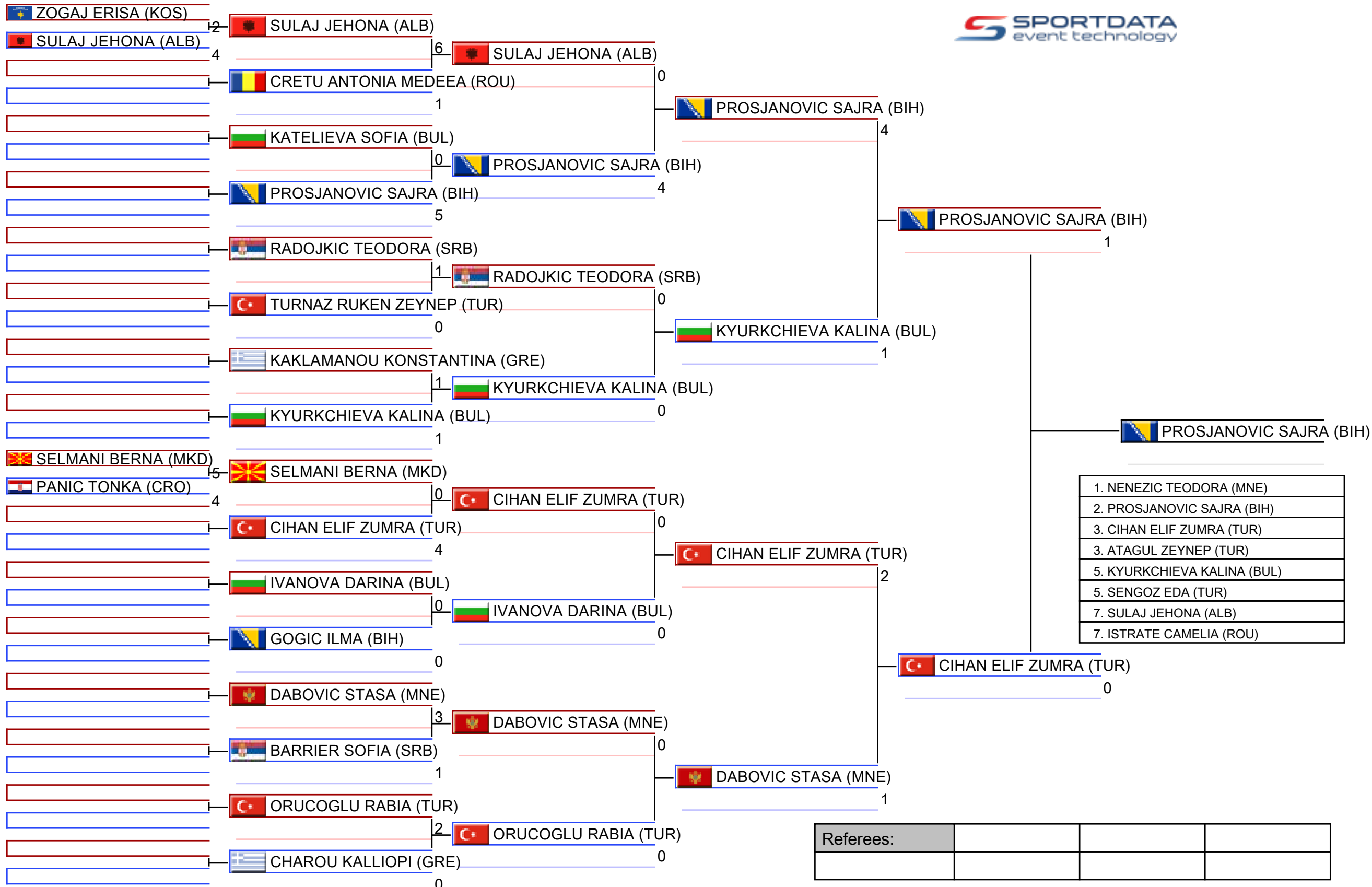

Referees:			

10 Yrs Kumite Female -30 kg

30th Balkan Karate Championships for Children 2026 - Istanbul, Basaksehir Spor Hall, Kayabaşı, TINAZTEPE CADDESİ NO:6, 34494 Başakşehir, İstanbul, TUR2026-05-29

Tatami

3 13:50

Pool

2/2

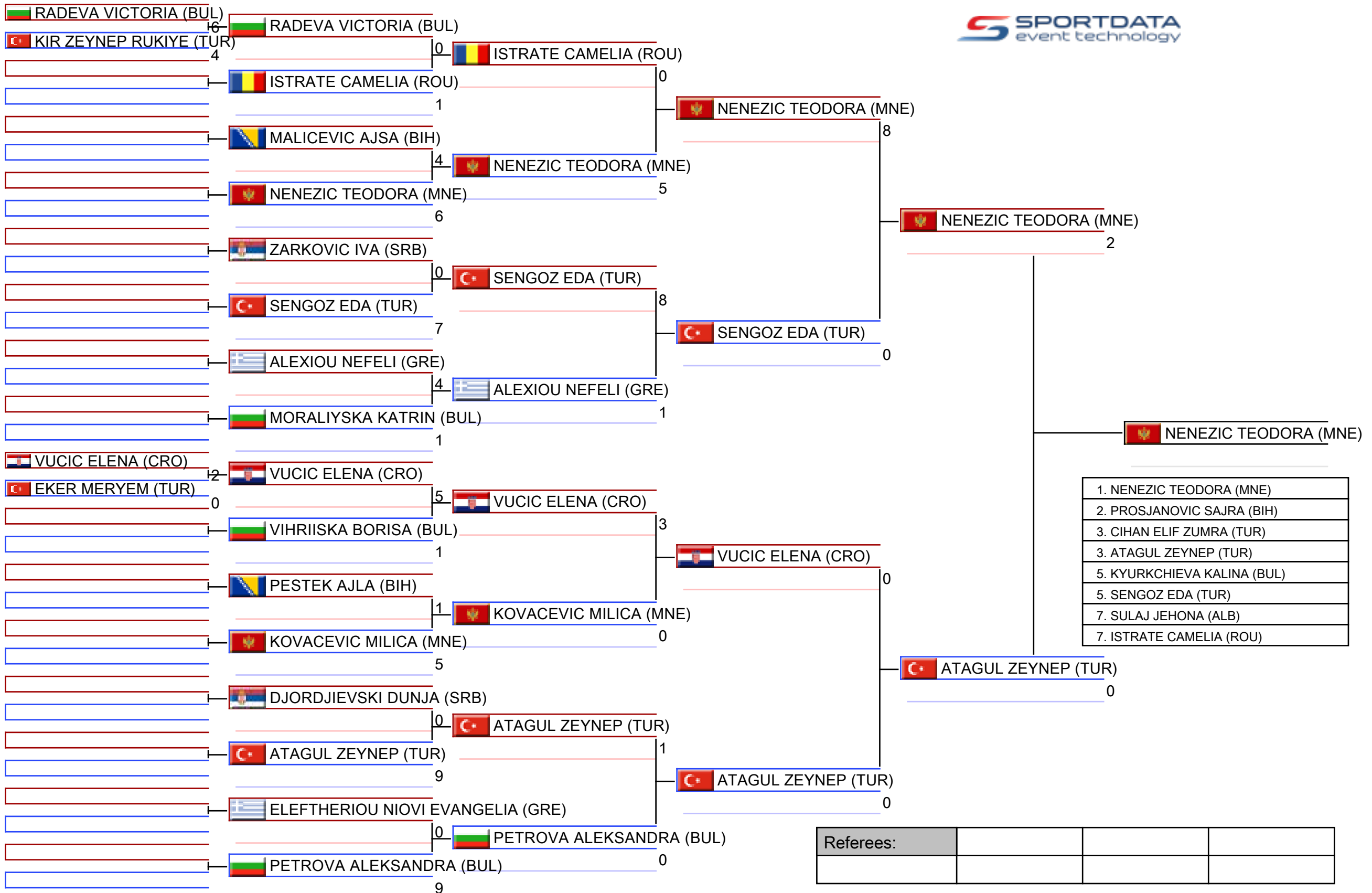

Referees:			

Pool winner-10 Yrs Kumite Female -30 kg

30th Balkan Karate Championships for Children 2026 - Istanbul, Basaksehir Spor Hall, Kayabaşı, TINAZTEPE CADDESİ NO:6, 34494 Başakşehir, İstanbul, TUR

Tatami

Pool

1/1

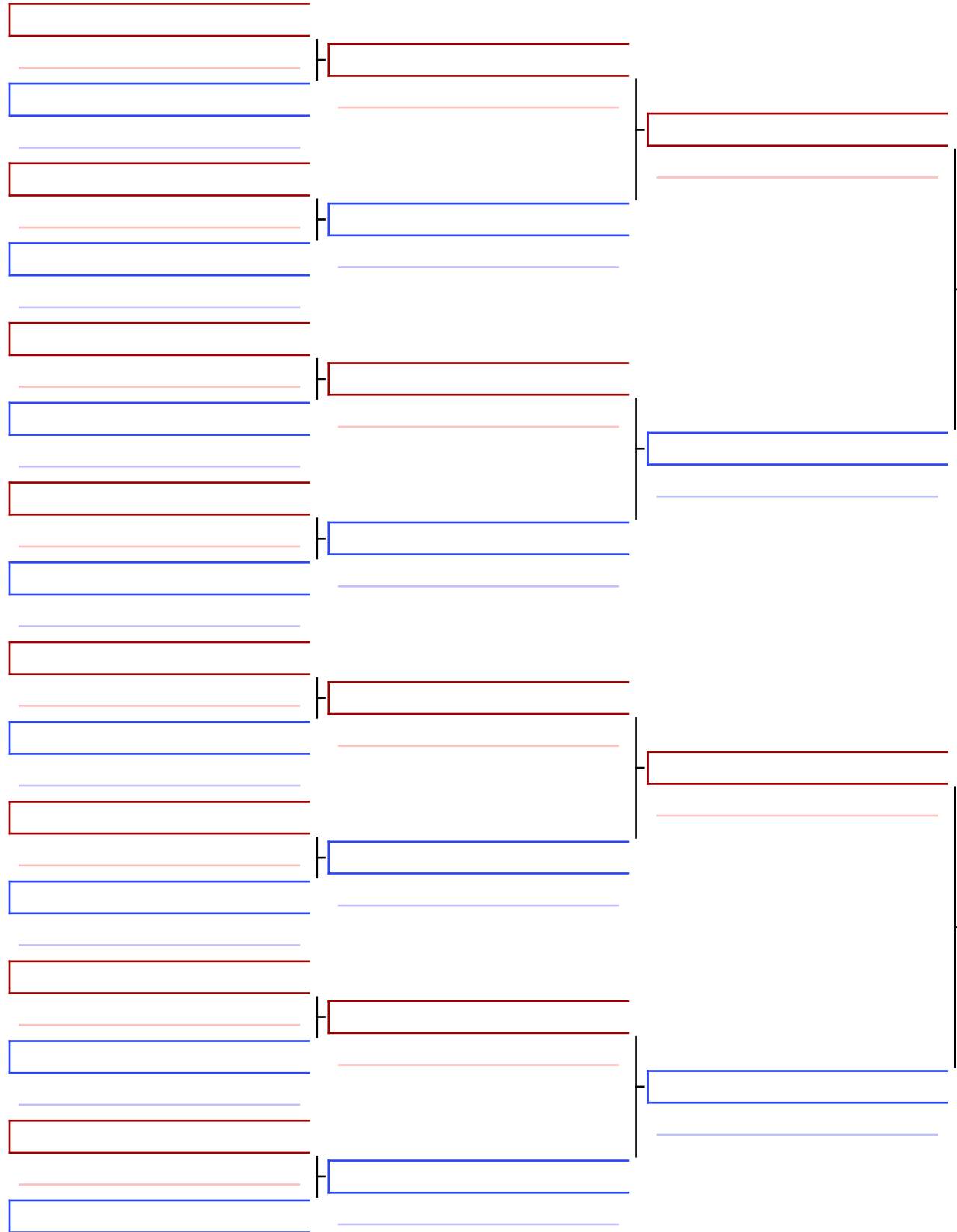

Final

 PROSJANOVIC SAJRA (BIH)

1

 NENEZIC TEODORA (MNE)

 NENEZIC TEODORA (MNE)

2

1. NENEZIC TEODORA (MNE)
2. PROSJANOVIC SAJRA (BIH)
3. CIHAN ELIF ZUMRA (TUR)
3. ATAGUL ZEYNEP (TUR)
5. KYURKCHIEVA KALINA (BUL)
5. SENGOZ EDA (TUR)
7. SULAJ JEHONA (ALB)
7. ISTRATE CAMELIA (ROU)

Referees:			

10 Yrs Kumite Female -30 kg

30th Balkan Karate Championships for Children 2026 - Istanbul

2026-05-29

Tatami
3 14:50

Pool
2,1

(c)sportdata GmbH & Co KG 2000-2026 (2026-05-31 14:44) v 12.2.0 build 1 (2026-05-24 19:07 CET) License: Lazar Piper SRB (expire 2027-01-23)

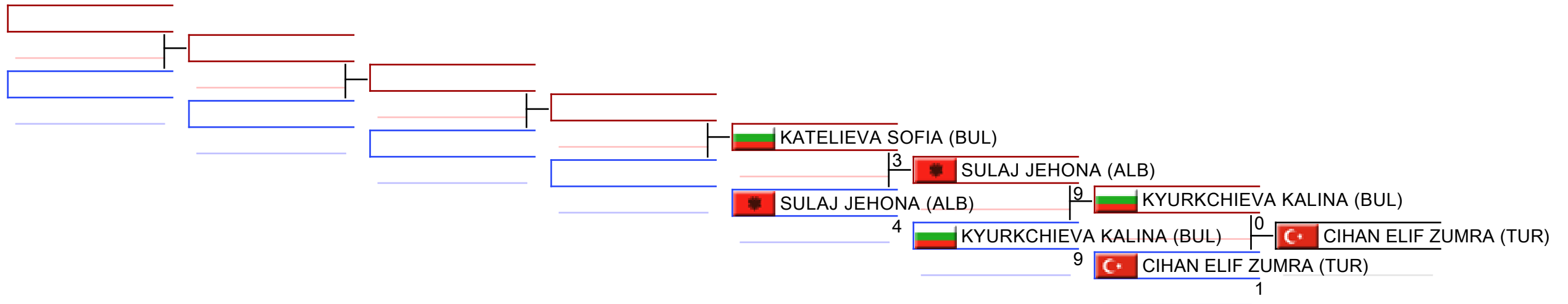

REPECHAGE: (2,1)

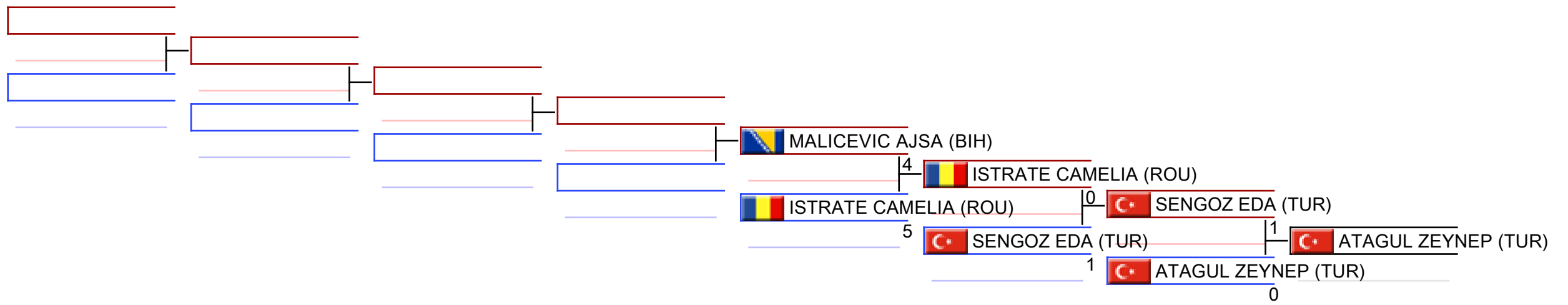

Referees:							
-----------	--	--	--	--	--	--	--

10 Yrs Kumite Female -34 kg

30th Balkan Karate Championships for Children 2026 - Istanbul, Basaksehir Spor Hall, Kayabaşı, TINAZTEPE CADDESİ NO:6, 34494 Başakşehir, İstanbul, TUR2026-05-31

Tatami

1 10:05

Pool

1/1

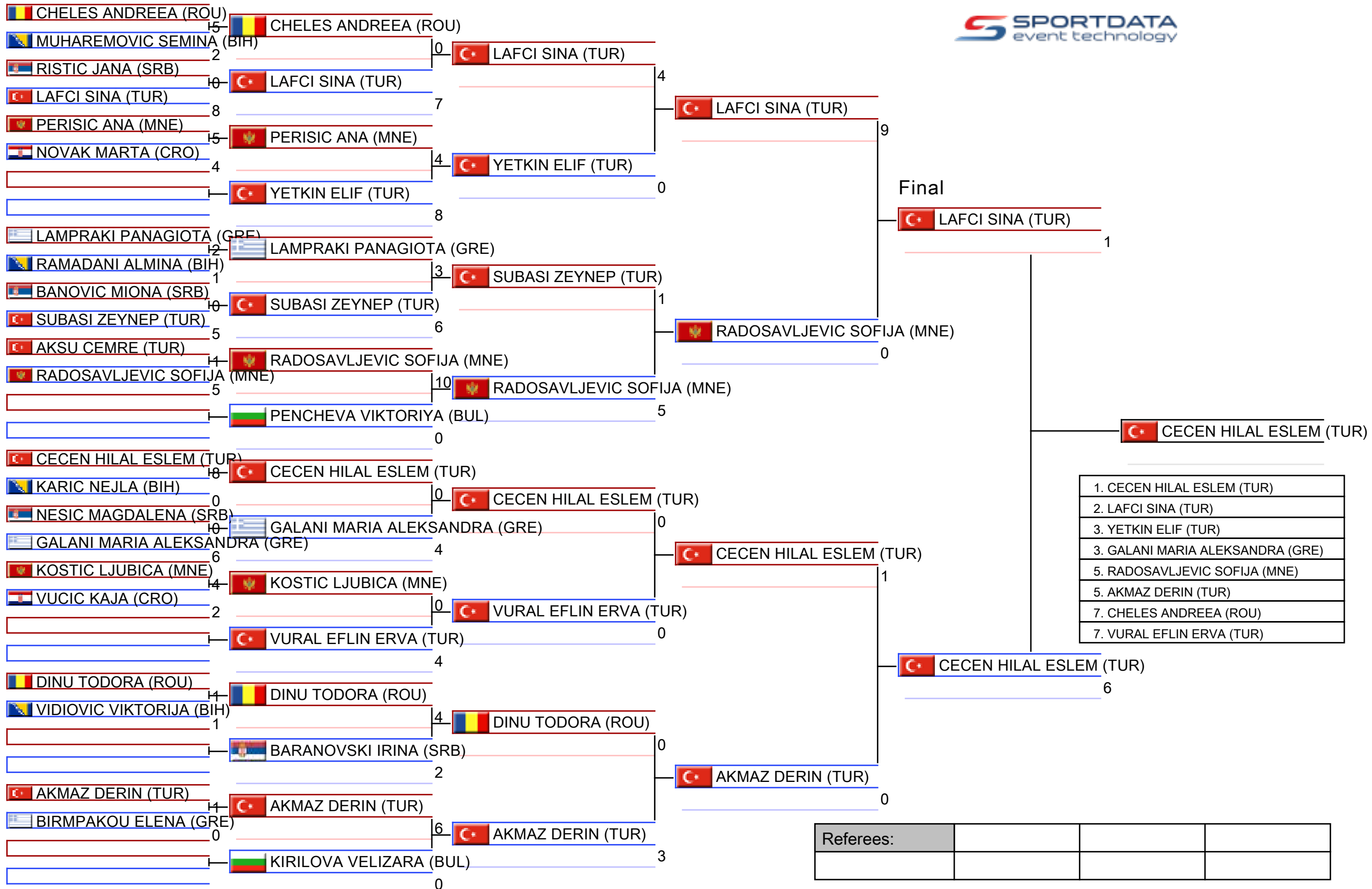

10 Yrs Kumite Female -34 kg

30th Balkan Karate Championships for Children 2026 - Istanbul

2026-05-31

Tatami
1 11:35

Pool
1

(c)sportdata GmbH & Co KG 2000-2026 (2026-05-31 14:44) v 12.2.0 build 1 (2026-05-24 19:07 CET) License: Lazar Piper SRB (expire 2027-01-23)

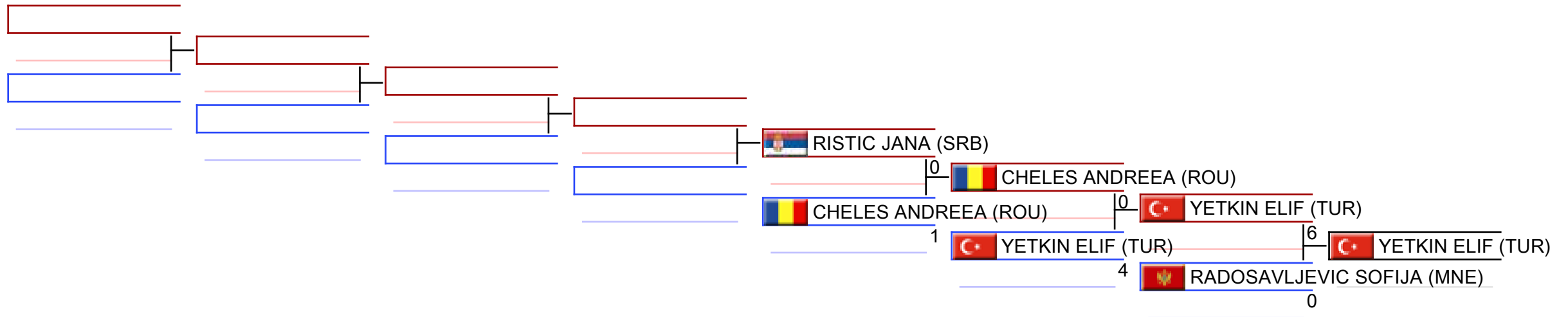

REPECHAGE: (1)

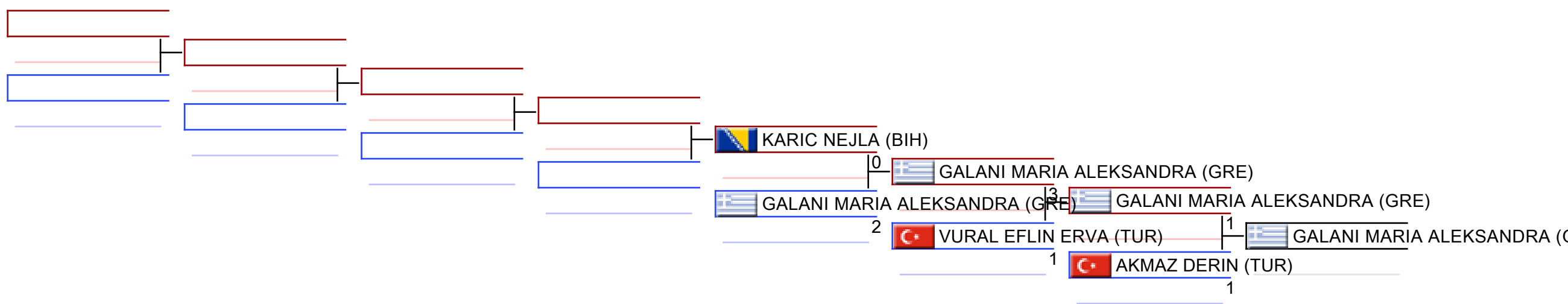

Referees:							
-----------	--	--	--	--	--	--	--

10 Yrs Kumite Female -37 kg

30th Balkan Karate Championships for Children 2026 - Istanbul, Basaksehir Spor Hall, Kayabaşı, TINAZTEPE CADDESİ NO:6, 34494 Başakşehir, İstanbul, TUR2026-05-29

Tatami

3 16:15

Pool

1/1

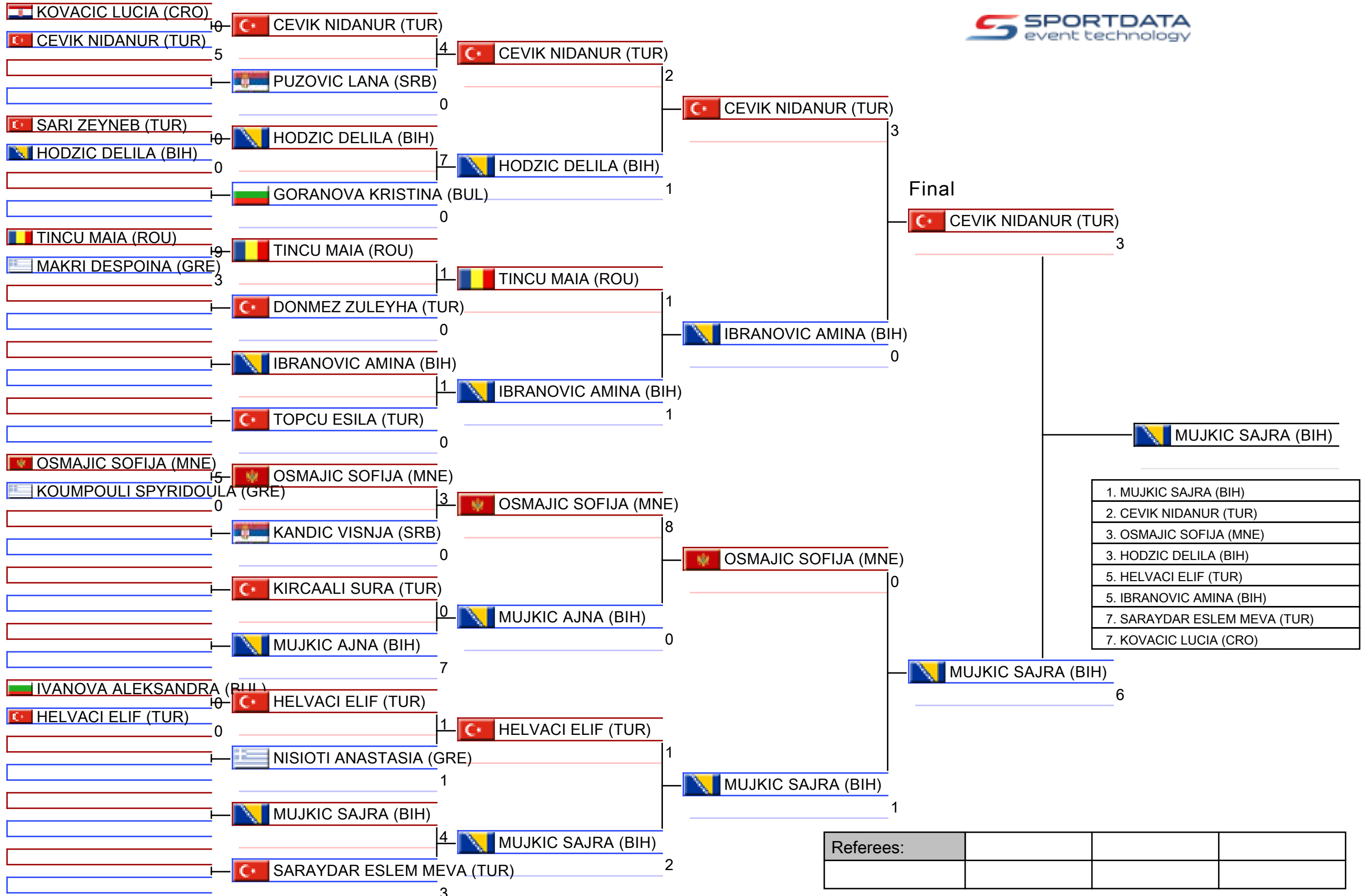

Referees:			

10 Yrs Kumite Female -37 kg

30th Balkan Karate Championships for Children 2026 - Istanbul

2026-05-29

Tatami
3 17:20

Pool
1

(c)sportdata GmbH & Co KG 2000-2026 (2026-05-31 14:44) v 12.2.0 build 1 (2026-05-24 19:07 CET) License: Lazar Piper SRB (expire 2027-01-23)

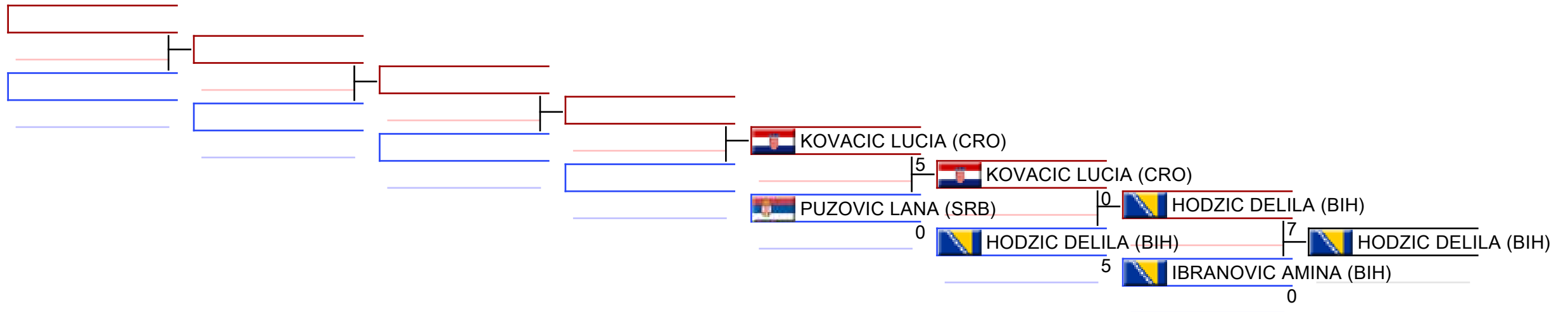

REPECHAGE: (1)

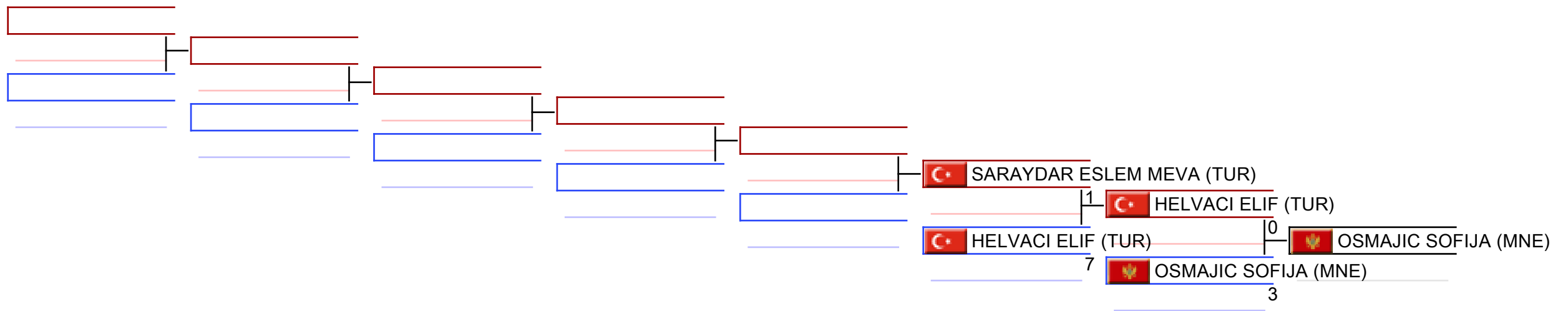

Referees:							
-----------	--	--	--	--	--	--	--

10 Yrs Kumite Female -40 kg

30th Balkan Karate Championships for Children 2026 - Istanbul, Basaksehir Spor Hall, Kayabaşı, TINAZTEPE CADDESİ NO:6, 34494 Başakşehir, İstanbul, TUR2026-05-31

Tatami

4 10:10

Pool

1/1

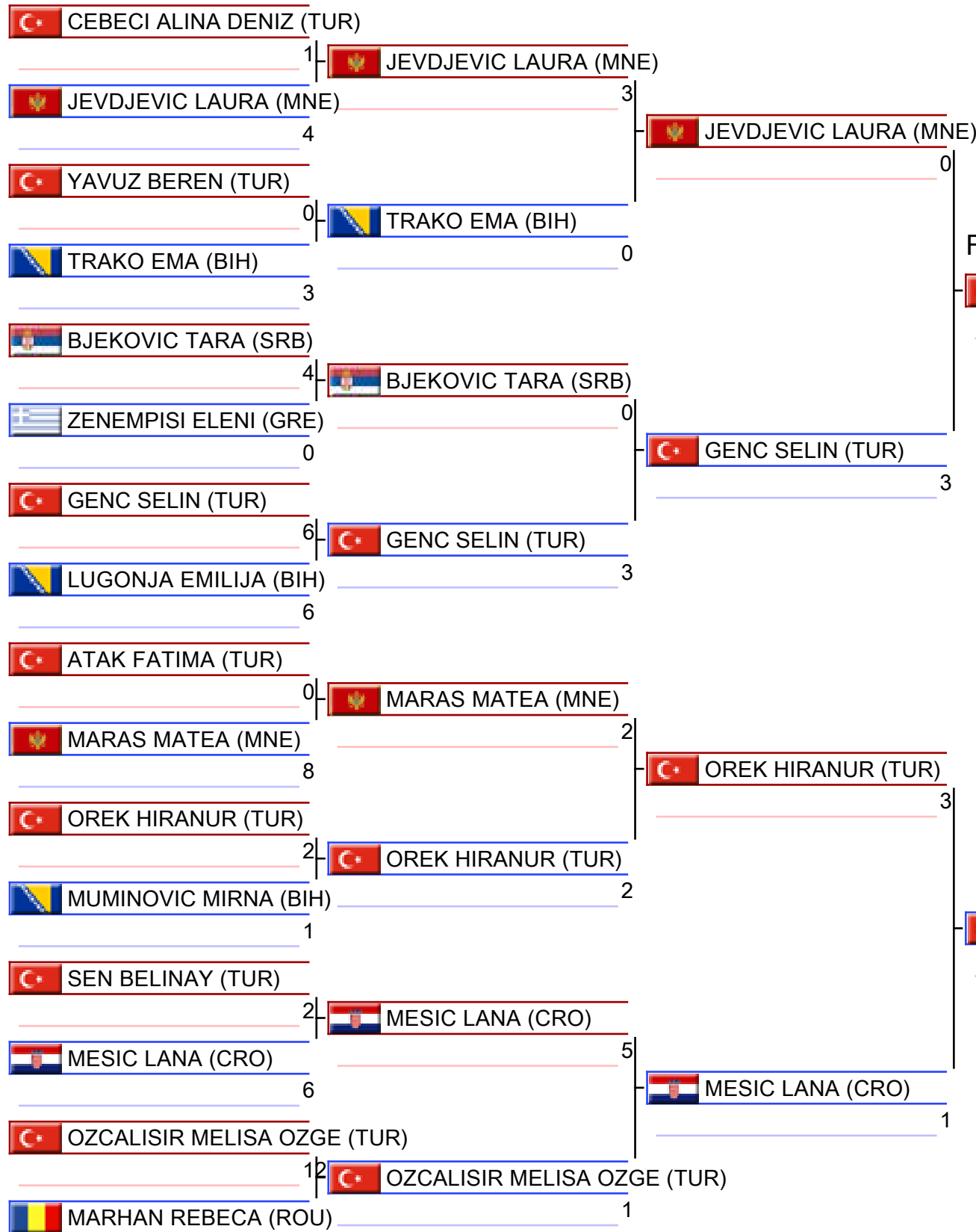

1. OREK HIRANUR (TUR)
2. GENC SELIN (TUR)
3. JEVDJEVIC LAURA (MNE)
3. MARAS MATEA (MNE)
5. LUGONJA EMILIJA (BIH)
5. MESIC LANA (CRO)
7. BJEKOVIC TARA (SRB)
7. MUMINOVIC MIRNA (BIH)

Referees:			

10 Yrs Kumite Female -40 kg

30th Balkan Karate Championships for Children 2026 - Istanbul

2026-05-31

Tatami
4 11:00

Pool
1

(c)sportdata GmbH & Co KG 2000-2026 (2026-05-31 14:44) v 12.2.0 build 1 (2026-05-24 19:07 CET) License: Lazar Piper SRB (expire 2027-01-23)

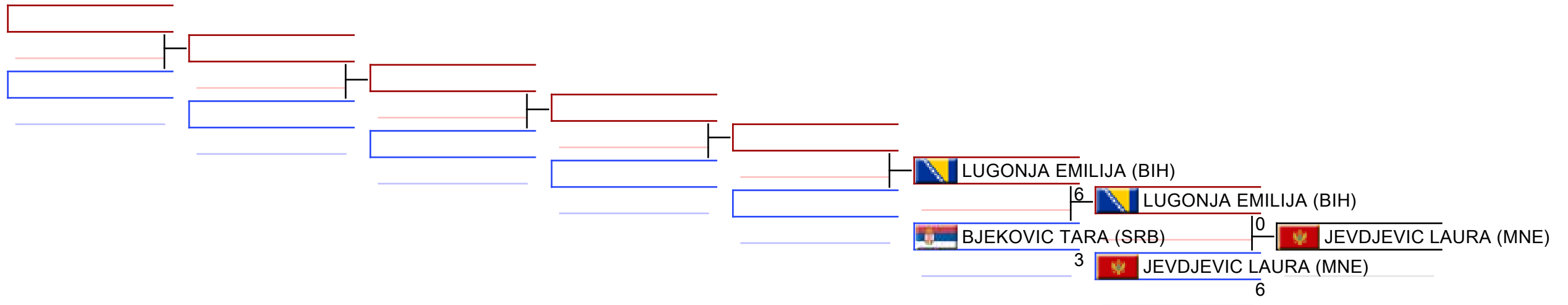

REPECHAGE: (1)

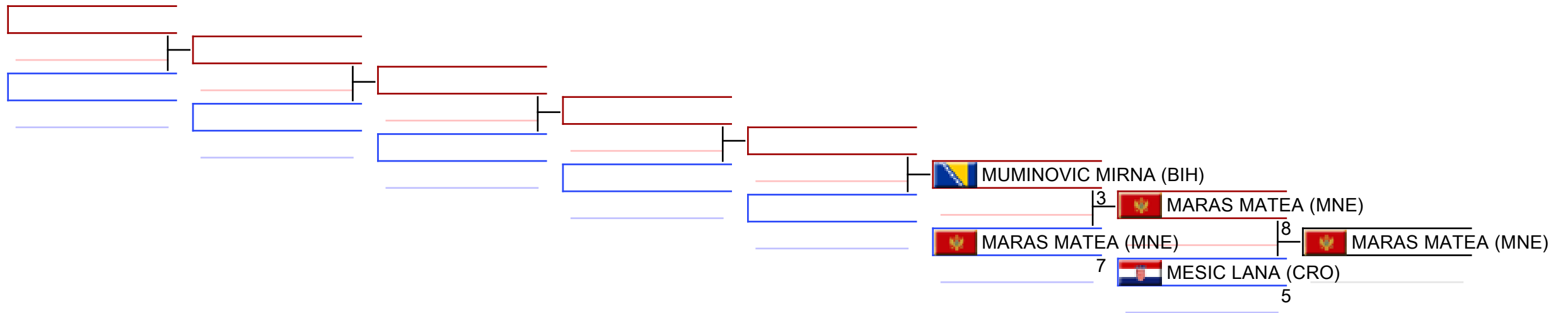

Referees:							
-----------	--	--	--	--	--	--	--

10 Yrs Kumite Female 40+ kg

30th Balkan Karate Championships for Children 2026 - Istanbul, Basaksehir Spor Hall, Kayabaşı, TINAZTEPE CADDESİ NO:6, 34494 Başakşehir, İstanbul, TUR2026-05-29

Tatami

1 12:55

Pool

1/1

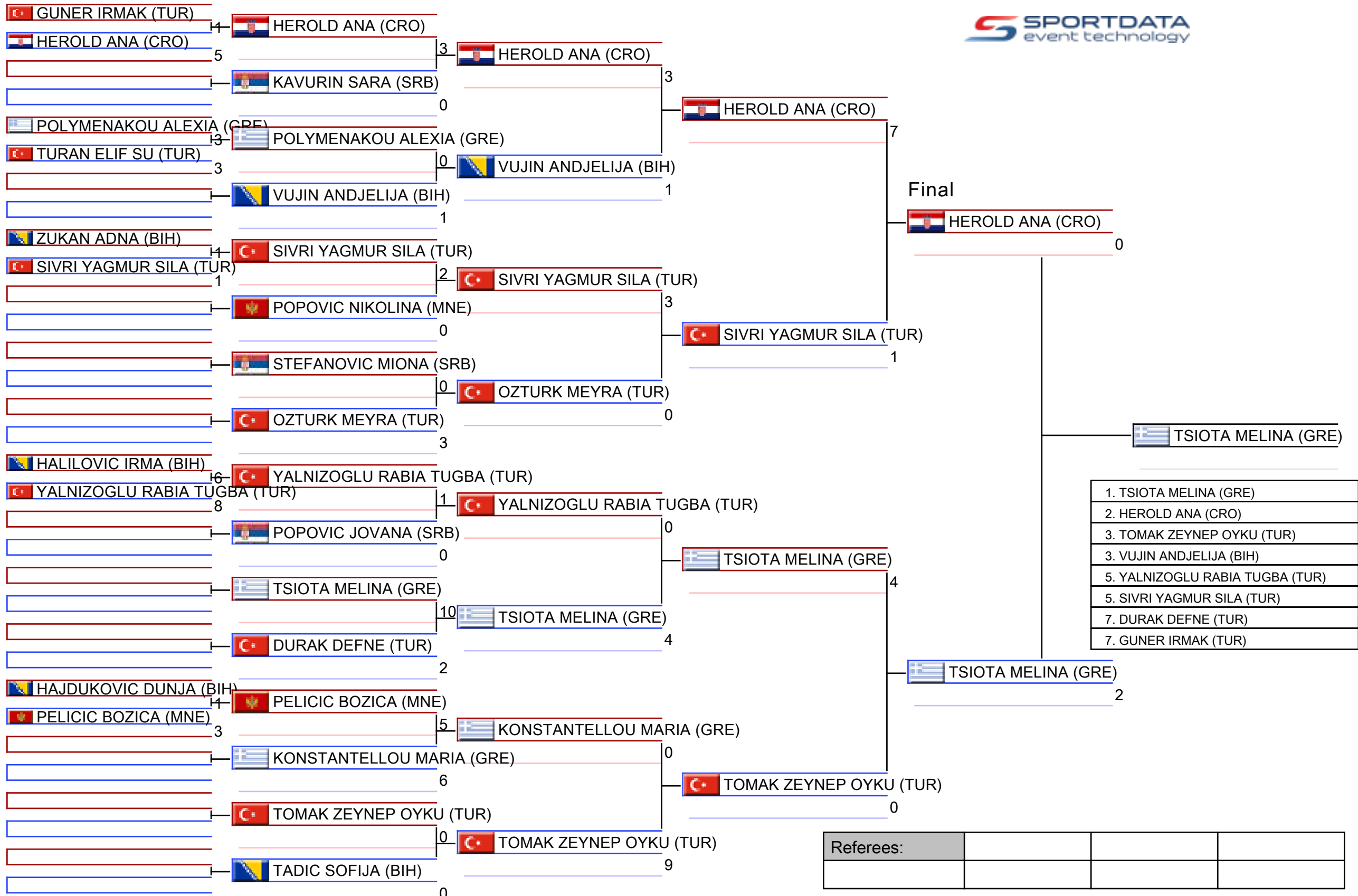

Referees:			

10 Yrs Kumite Female 40+ kg

30th Balkan Karate Championships for Children 2026 - Istanbul

2026-05-29

Tatami
1 14:00

Pool
1

(c)sportdata GmbH & Co KG 2000-2026 (2026-05-31 14:44) v 12.2.0 build 1 (2026-05-24 19:07 CET) License: Lazar Piper SRB (expire 2027-01-23)

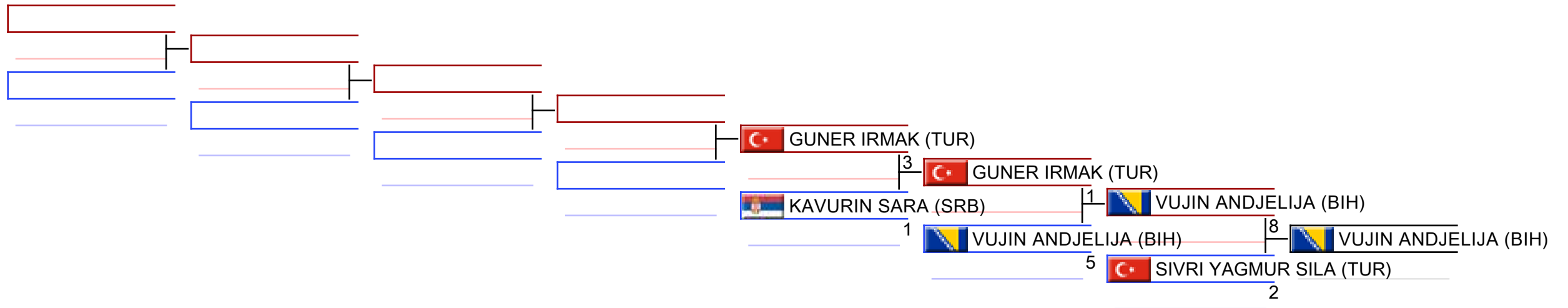

REPECHAGE: (1)

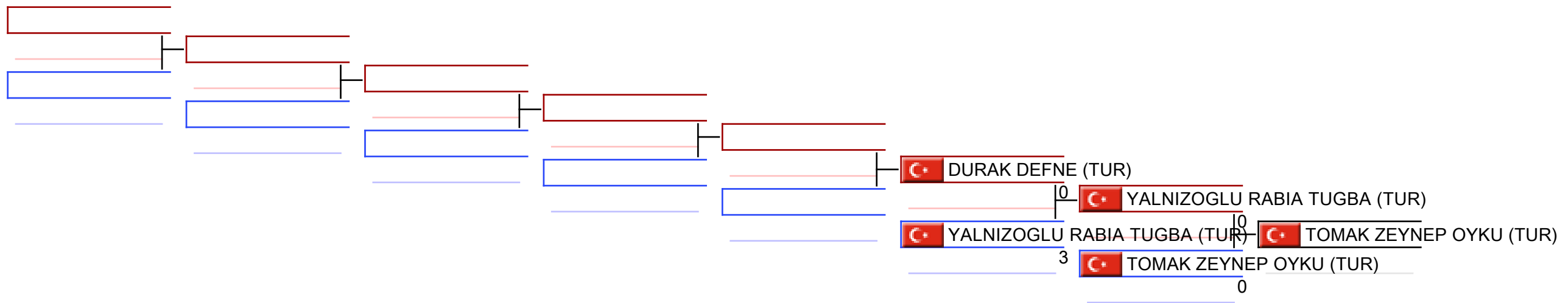

Referees:							
-----------	--	--	--	--	--	--	--

10 Yrs Kumite Male -30 kg

30th Balkan Karate Championships for Children 2026 - Istanbul, Basaksehir Spor Hall, Kayabaşı, TINAZTEPE CADDESİ NO:6, 34494 Başakşehir, İstanbul, TUR2026-05-30

Tatami
6 11:45

Pool
1/1

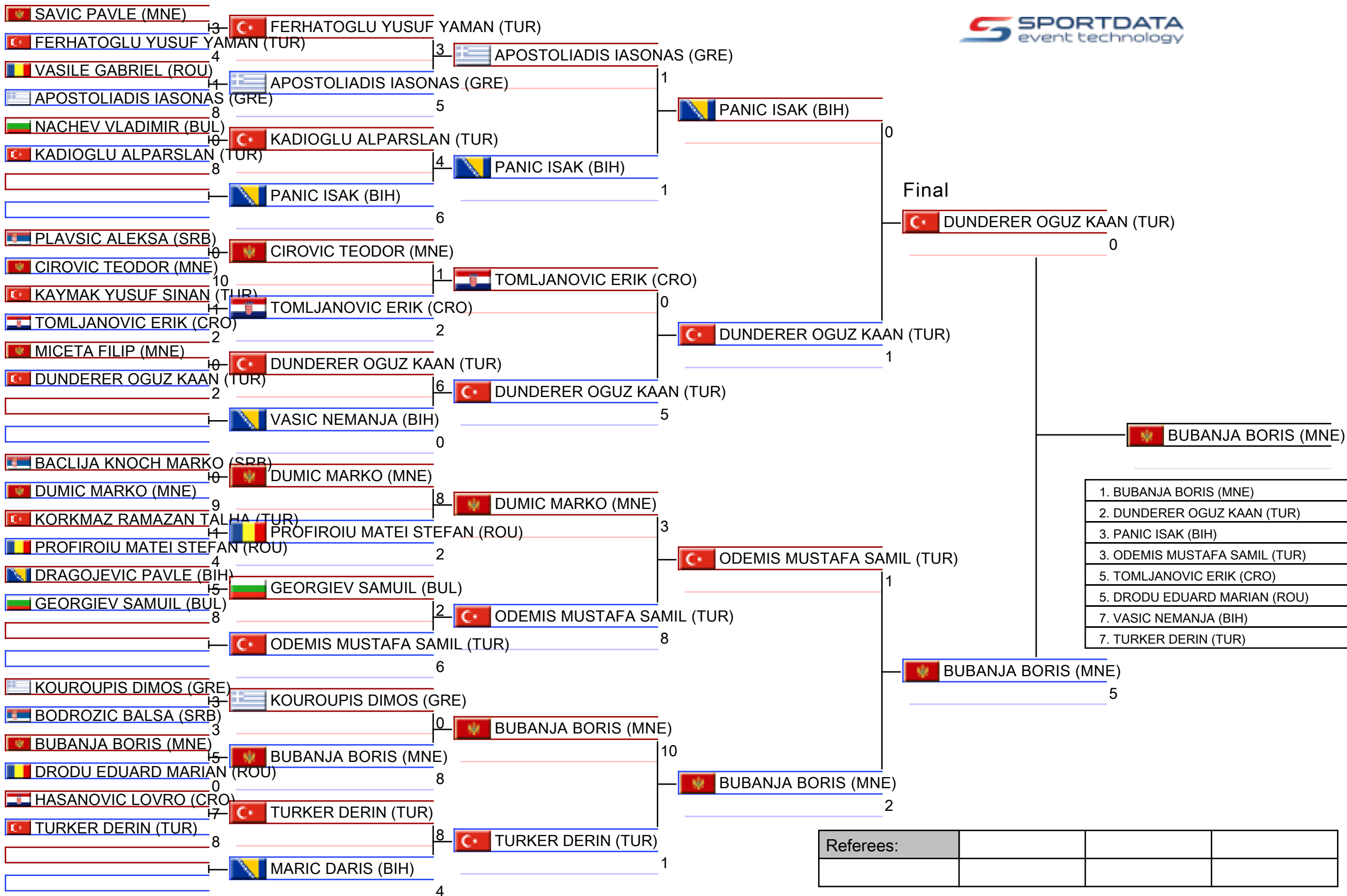

Referees:			

10 Yrs Kumite Male -30 kg

30th Balkan Karate Championships for Children 2026 - Istanbul

2026-05-30

Tatami
6 13:15

Pool
1

(c)sportdata GmbH & Co KG 2000-2026 (2026-05-31 14:44) v 12.2.0 build 1 (2026-05-24 19:07 CET) License: Lazar Piper SRB (expire 2027-01-23)

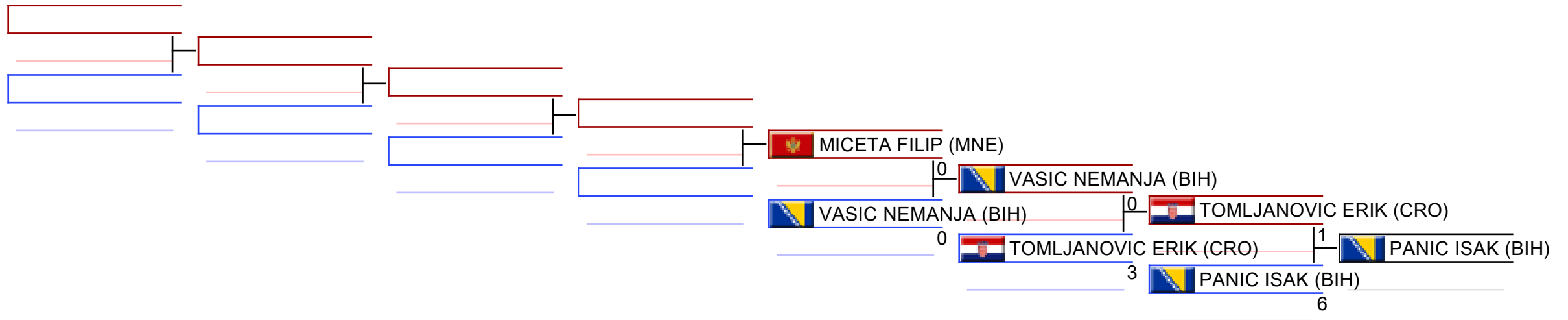

REPECHAGE: (1)

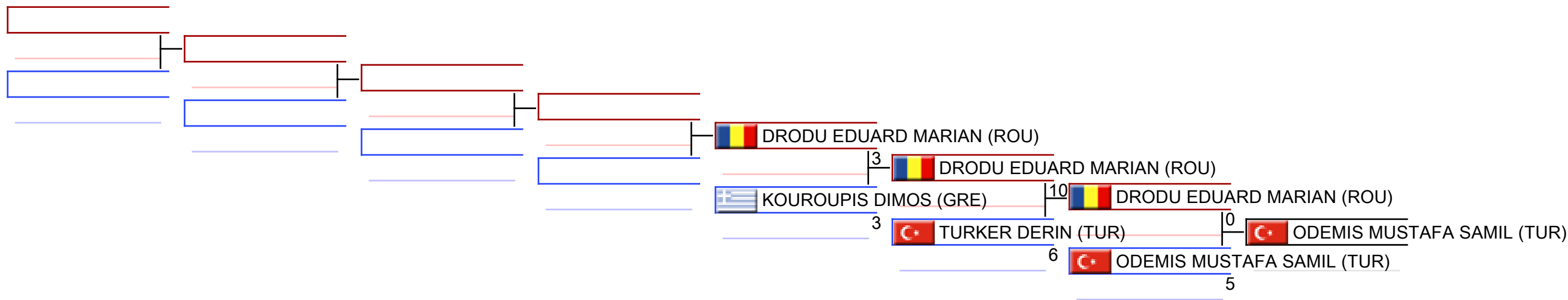

Referees:							
-----------	--	--	--	--	--	--	--

10 Yrs Kumite Male -35 kg

30th Balkan Karate Championships for Children 2026 - Istanbul, Basaksehir Spor Hall, Kayabaşı, TINAZTEPE CADDESİ NO:6, 34494 Başakşehir, İstanbul, TUR2026-05-30

Tatami

6 14:10

Pool

1/1

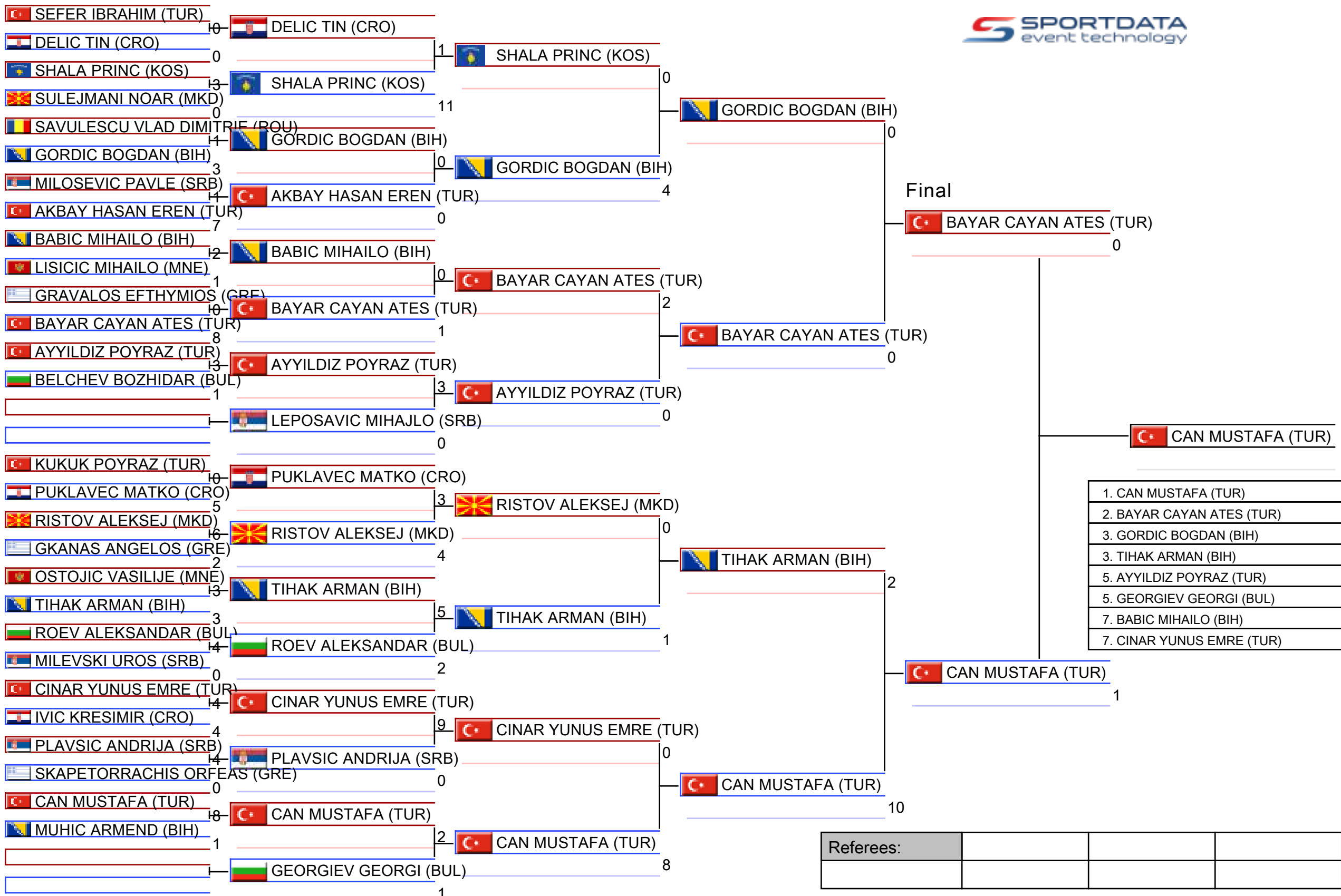

Referees:			

10 Yrs Kumite Male -35 kg

30th Balkan Karate Championships for Children 2026 - Istanbul

2026-05-30

Tatami
6 15:50

Pool
1

(c)sportdata GmbH & Co KG 2000-2026 (2026-05-31 14:44) v 12.2.0 build 1 (2026-05-24 19:07 CET) License: Lazar Piper SRB (expire 2027-01-23)

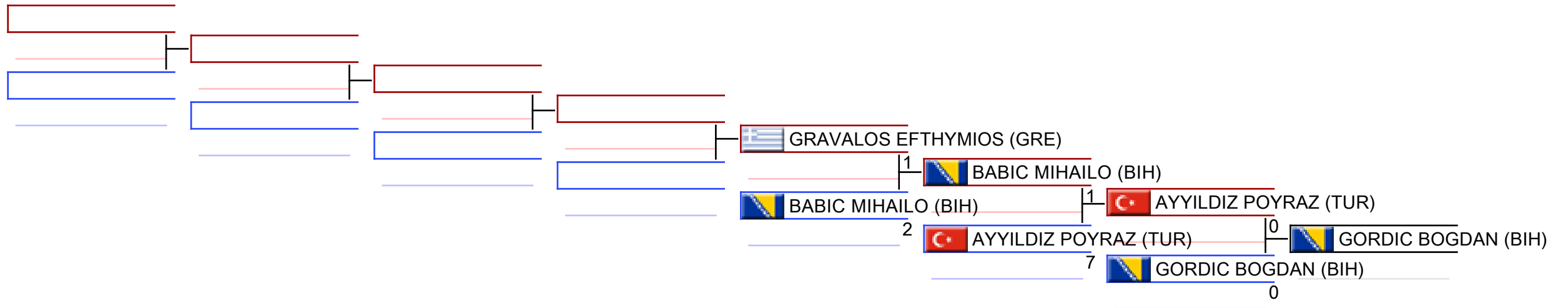

REPECHAGE: (1)

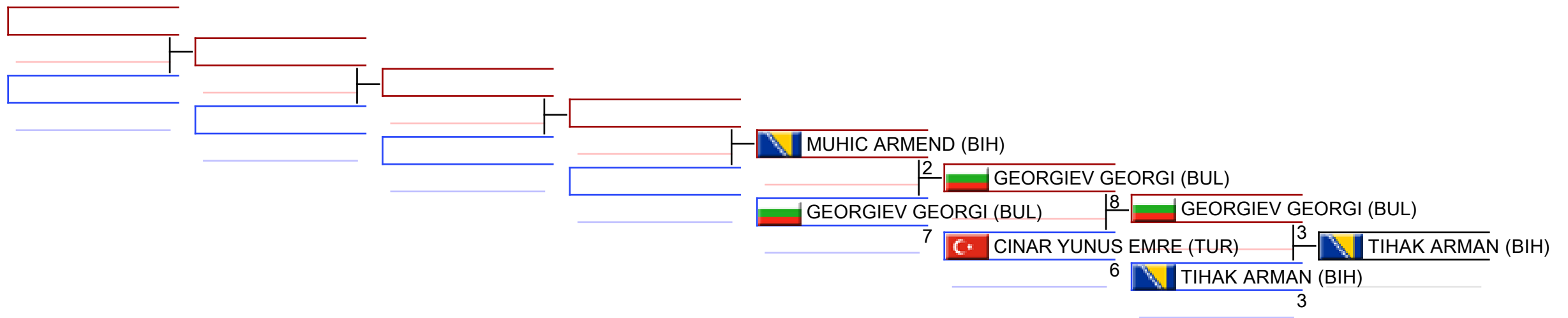

Referees:							
-----------	--	--	--	--	--	--	--

10 Yrs Kumite Male -40 kg

30th Balkan Karate Championships for Children 2026 - Istanbul, Basaksehir Spor Hall, Kayabaşı, TINAZTEPE CADDESİ NO:6, 34494 Başakşehir, İstanbul, TUR2026-05-31

Tatami

2 13:00

Pool

1/1

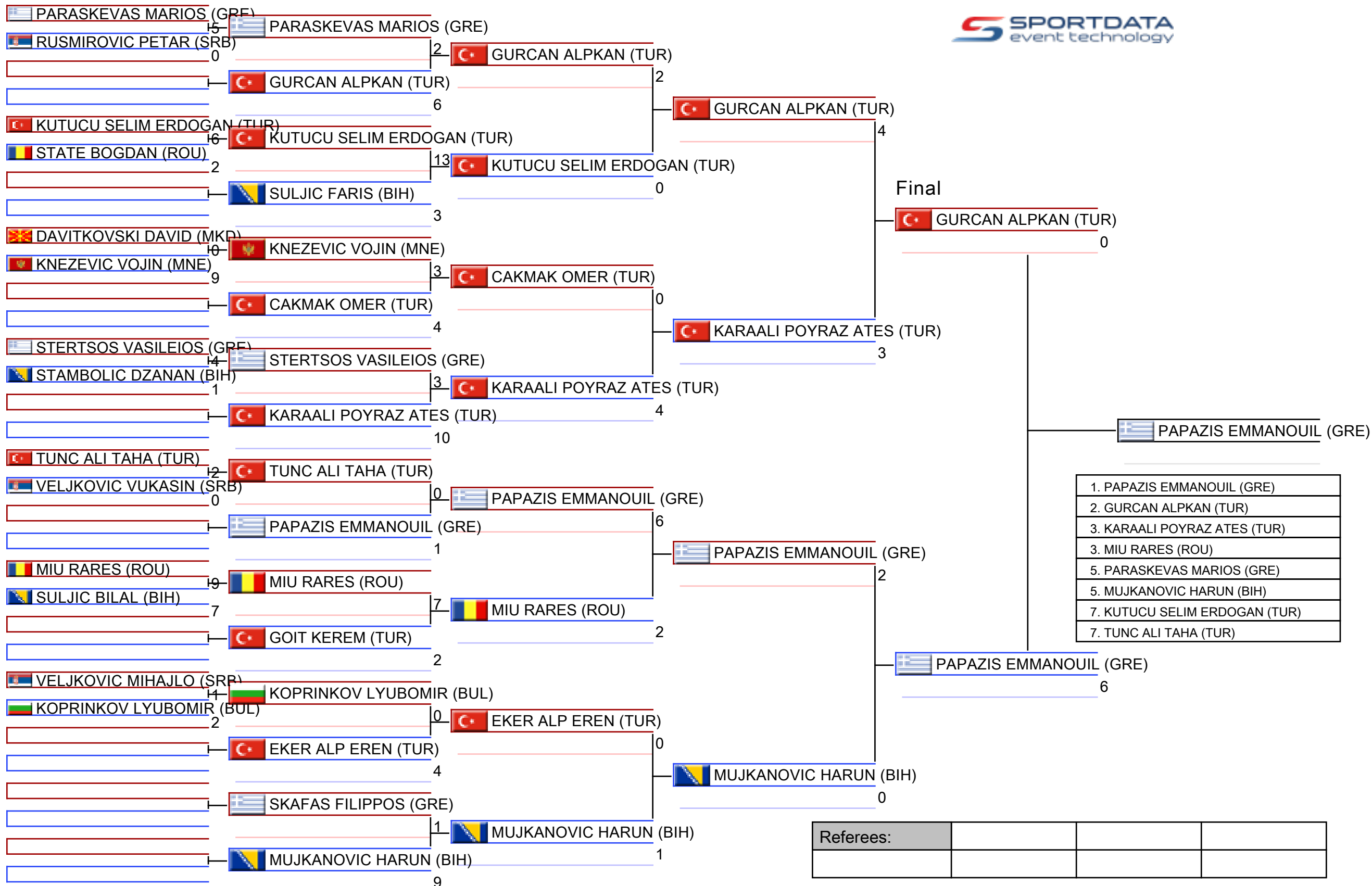

Referees:			

10 Yrs Kumite Male -40 kg

30th Balkan Karate Championships for Children 2026 - Istanbul

(c)sportdata GmbH & Co KG 2000-2026 (2026-05-31 14:44) v 12.2.0 build 1 (2026-05-24 19:07 CET) License: Lazar Piper SRB (expire 2027-01-23)

2026-05-31

Tatami
2 14:15

Pool
1

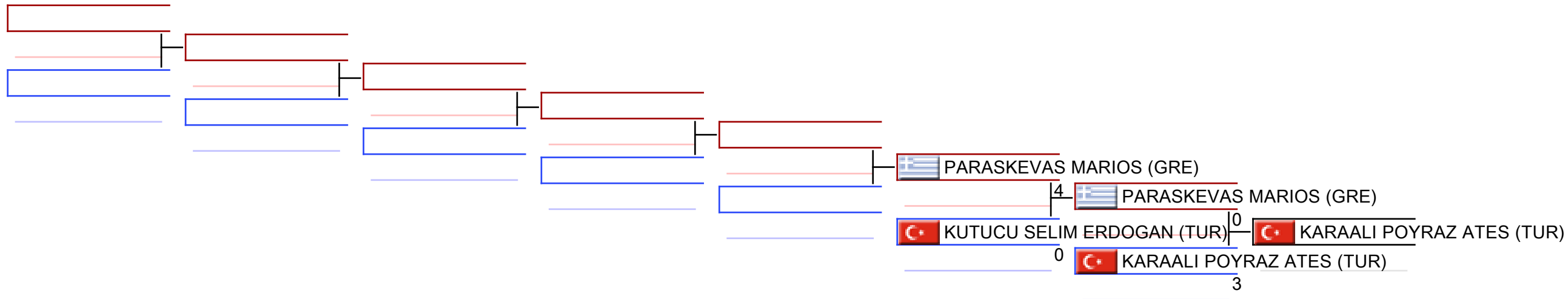

REPECHAGE: (1)

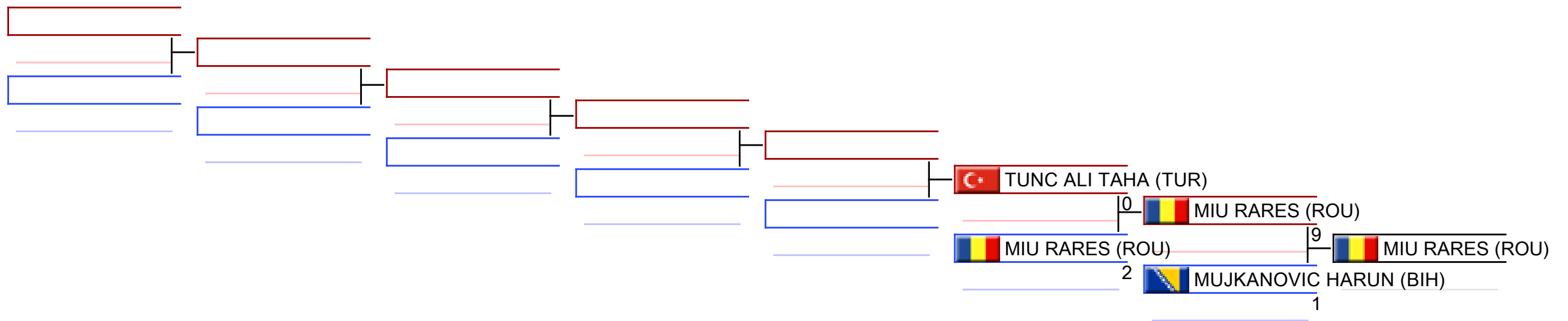

Referees:							
-----------	--	--	--	--	--	--	--

10 Yrs Kumite Male -45 kg

30th Balkan Karate Championships for Children 2026 - Istanbul, Basaksehir Spor Hall, Kayabaşı, TINAZTEPE CADDESİ NO:6, 34494 Başakşehir, İstanbul, TUR2026-05-30

Tatami

4 13:15

Pool

1/1

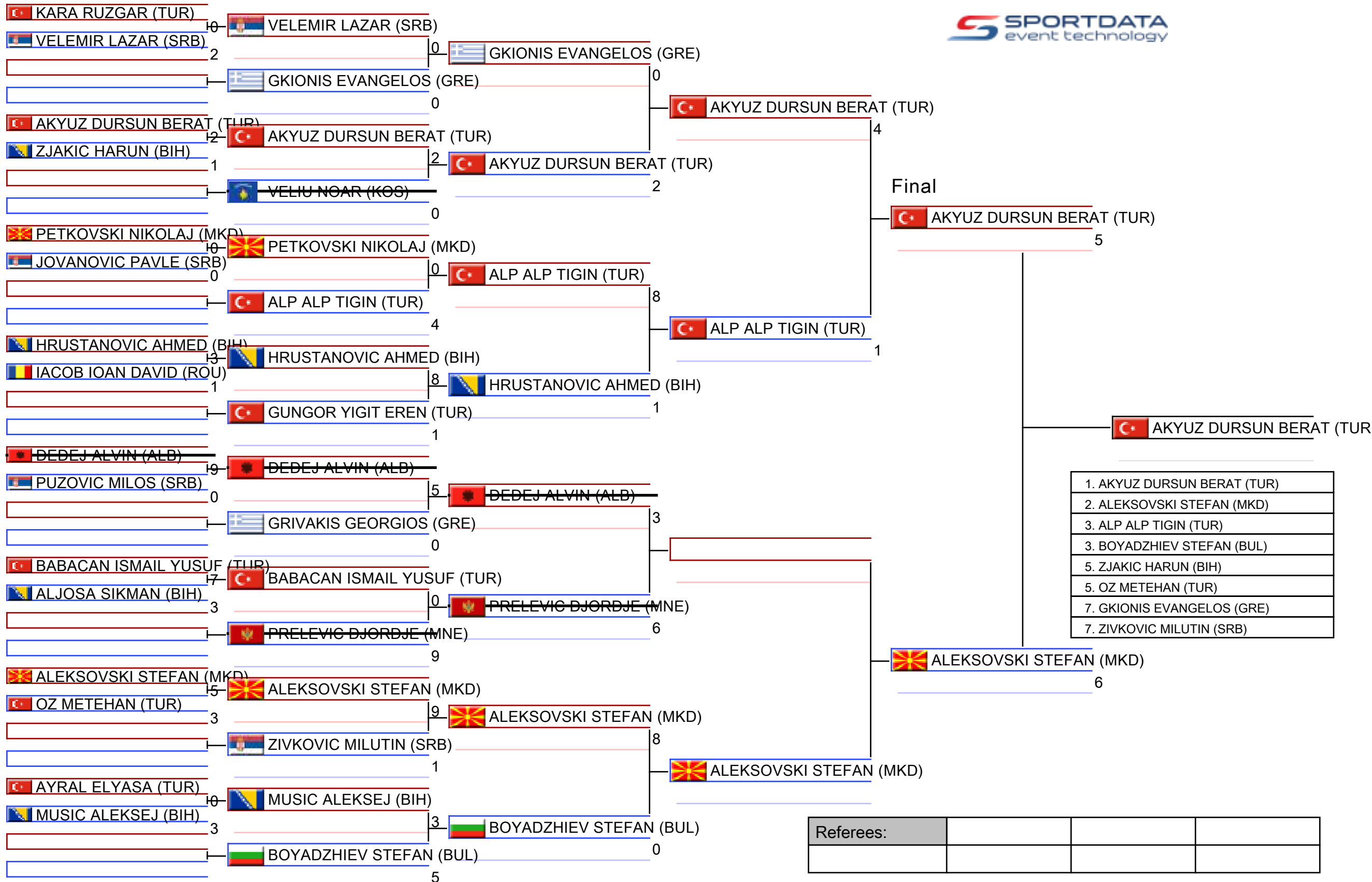

10 Yrs Kumite Male -45 kg

30th Balkan Karate Championships for Children 2026 - Istanbul

2026-05-30

Tatami
4 15:05

Pool
1

(c)sportdata GmbH & Co KG 2000-2026 (2026-05-31 14:44) v 12.2.0 build 1 (2026-05-24 19:07 CET) License: Lazar Piper SRB (expire 2027-01-23)

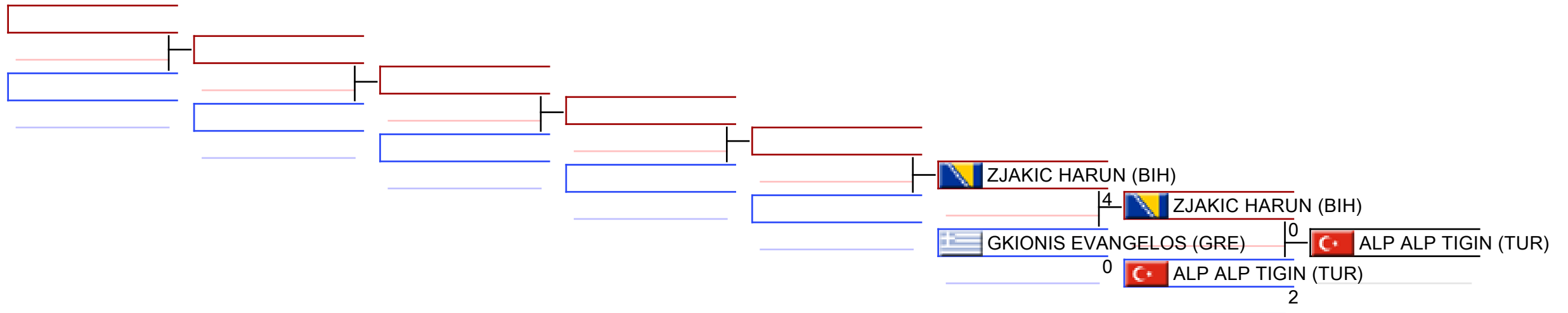

REPECHAGE: (1)

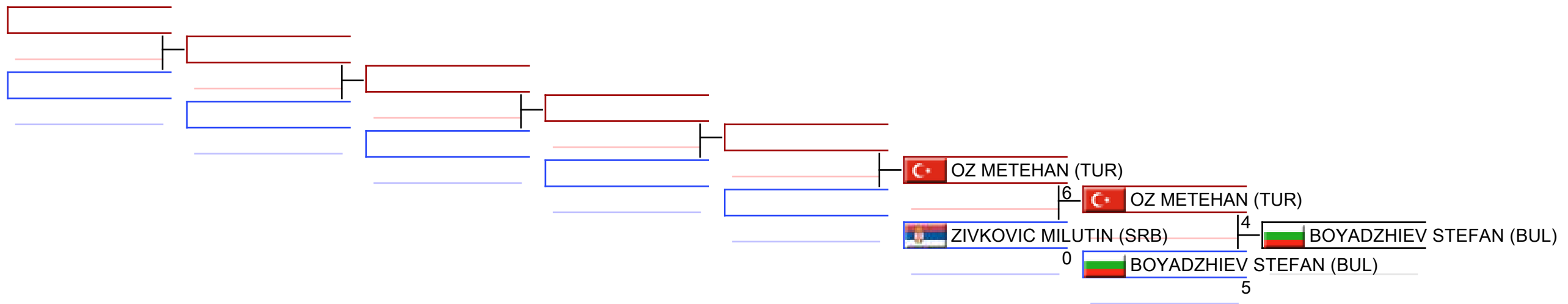

Referees:							
-----------	--	--	--	--	--	--	--

10 Yrs Kumite Male 45+ kg

30th Balkan Karate Championships for Children 2026 - Istanbul, Basaksehir Spor Hall, Kayabaşı, TINAZTEPE CADDESİ NO:6, 34494 Başakşehir, İstanbul, TUR2026-05-30

Tatami

5 12:10

Pool

1/1

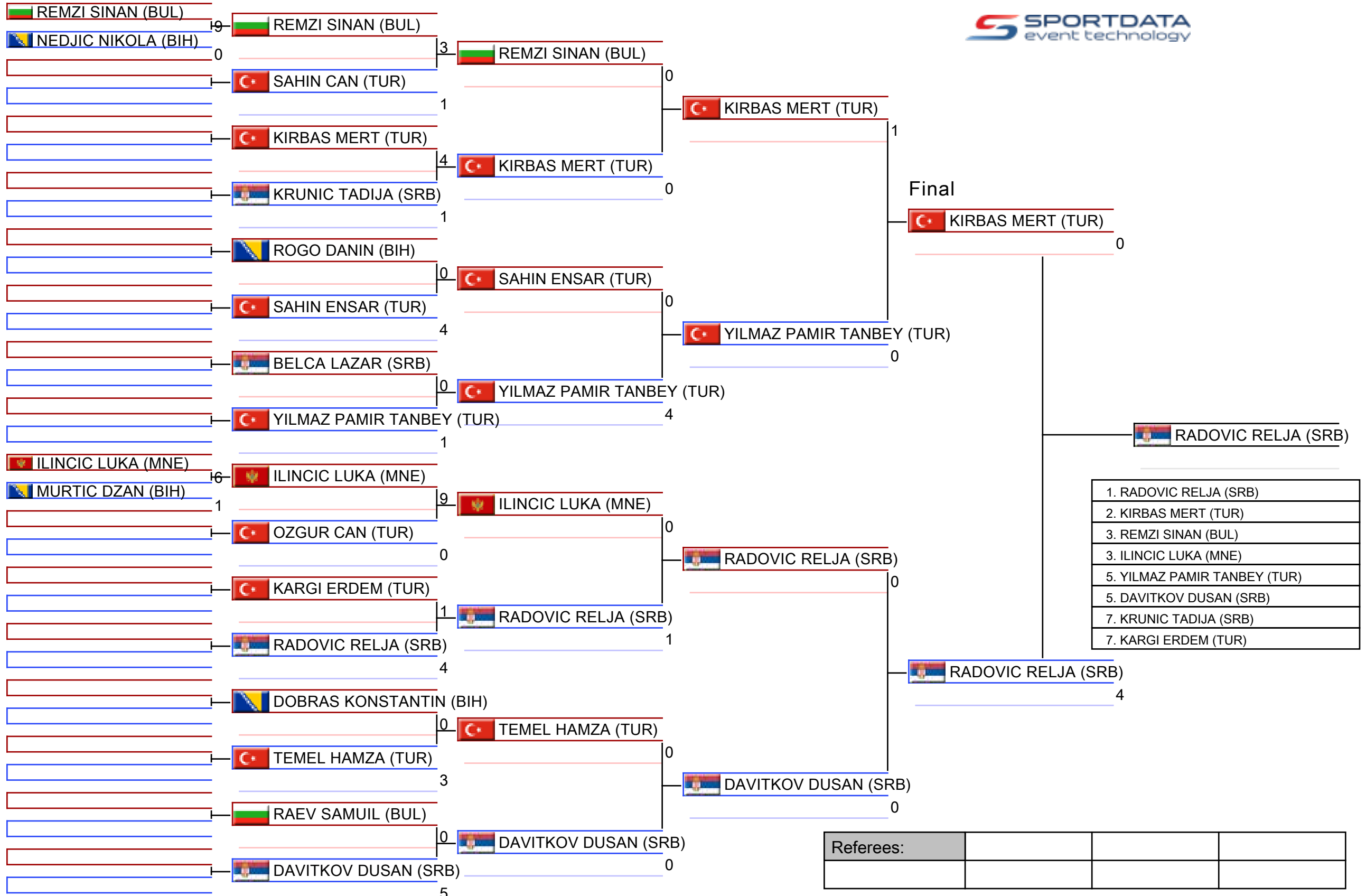

Referees:			

10 Yrs Kumite Male 45+ kg

30th Balkan Karate Championships for Children 2026 - Istanbul

2026-05-30

Tatami
5 13:05

Pool
1

(c)sportdata GmbH & Co KG 2000-2026 (2026-05-31 14:44) v 12.2.0 build 1 (2026-05-24 19:07 CET) License: Lazar Piper SRB (expire 2027-01-23)

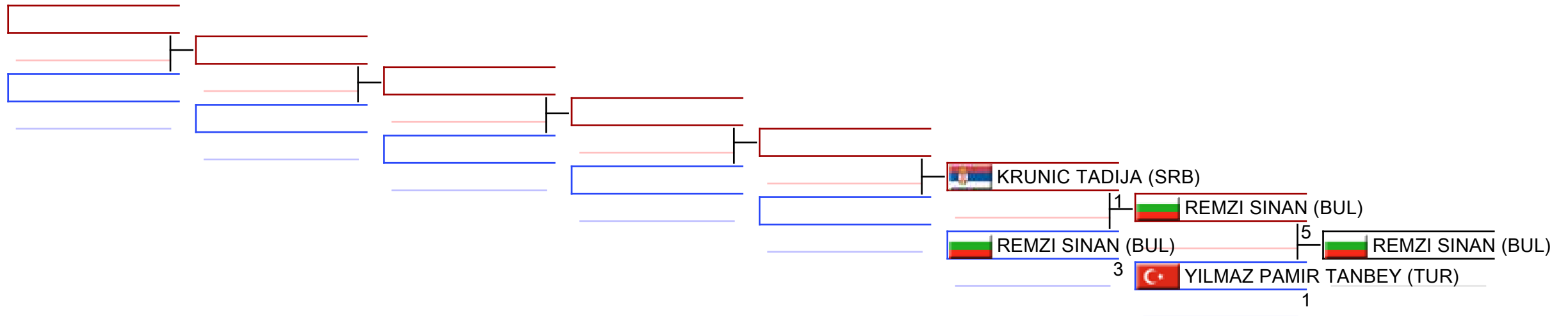

REPECHAGE: (1)

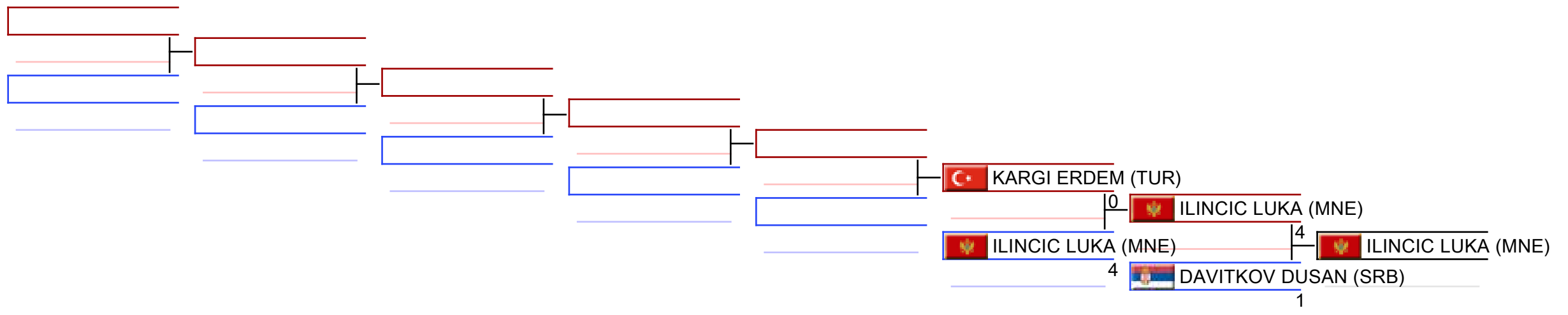

Referees:							
-----------	--	--	--	--	--	--	--

11 Yrs Kata Individual Female

30th Balkan Karate Championships for Children 2026 - Istanbul, Basaksehir Spor Hall, Kayabaşı, TINAZTEPE CADDESİ NO:6, 34494 Başakşehir, İstanbul, TUR2026-05-30

Tatami

3 09:00

Pool

1/2

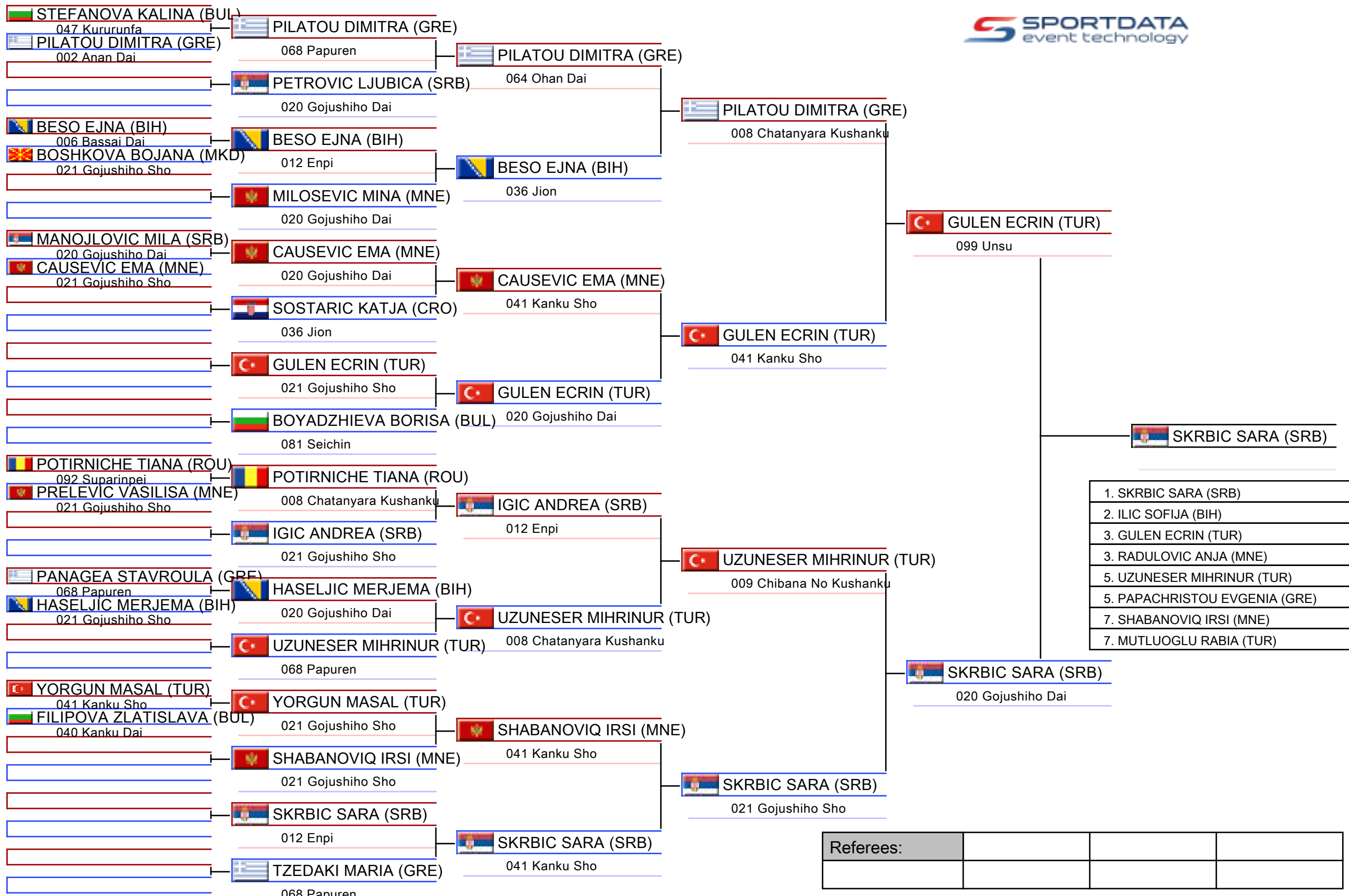

11 Yrs Kata Individual Female

30th Balkan Karate Championships for Children 2026 - Istanbul, Basaksehir Spor Hall, Kayabaşı, TINAZTEPE CADDESİ NO:6, 34494 Başakşehir, İstanbul, TUR2026-05-30

Tatami

4 09:00

Pool

2/2

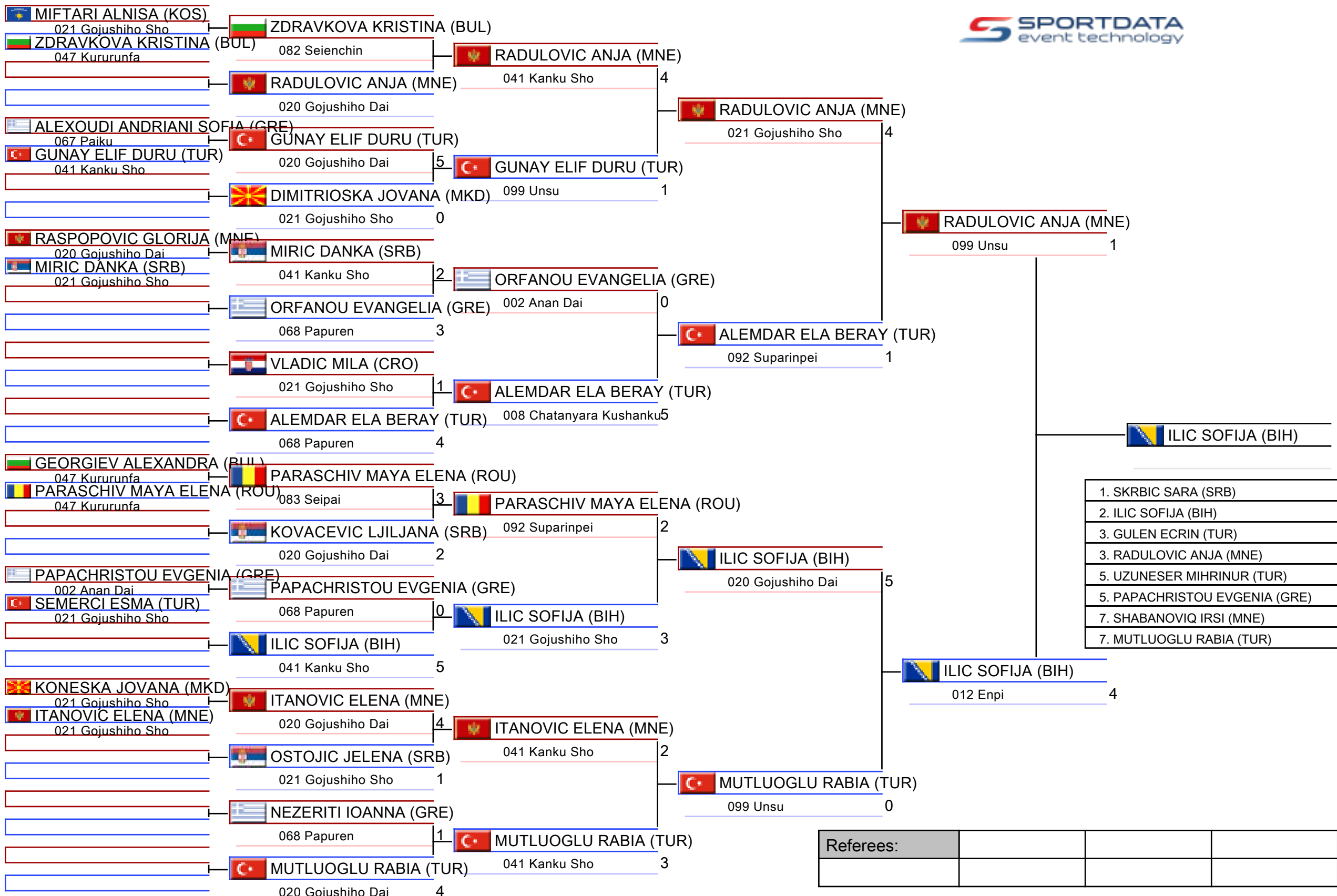

1. SKRBIC SARA (SRB)
2. ILIC SOFIJA (BIH)
3. GULEN ECRIN (TUR)
3. RADULOVIC ANJA (MNE)
5. UZUNESER MIHRINUR (TUR)
5. PACHRISTOU EVGENIA (GRE)
7. SHABANOVIQ IRSI (MNE)
7. MUTLUOGLU RABIA (TUR)

Referees:			

Pool winner-11 Yrs Kata Individual Female

30th Balkan Karate Championships for Children 2026 - Istanbul, Basaksehir Spor Hall, Kayabaşı, TINAZTEPE CADDESİ NO:6, 34494 Başakşehir, İstanbul, TUR

Tatami

Pool
1/1

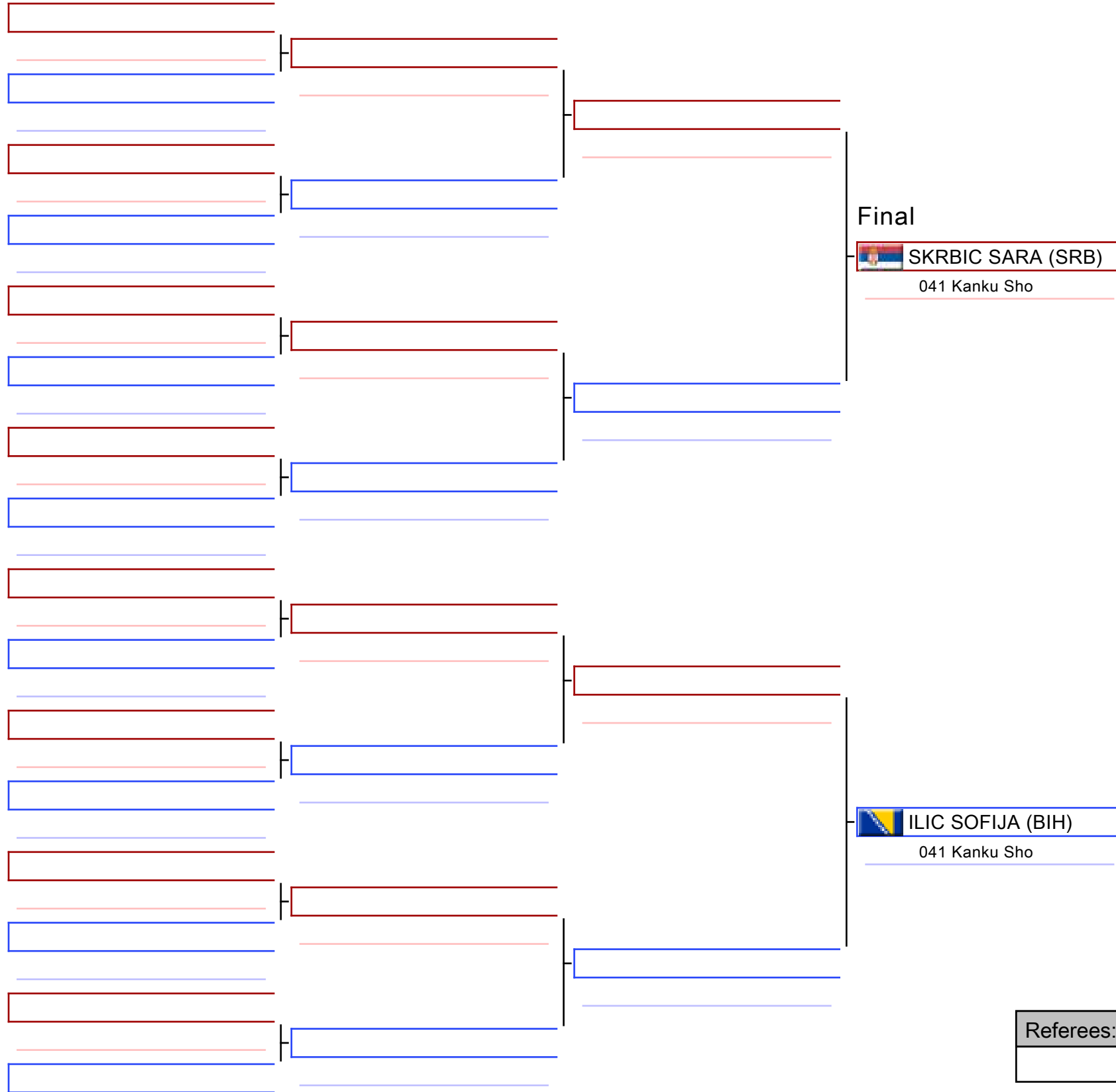

Final

 SKRBIC SARA (SRB)
041 Kanku Sho

 SKRBIC SARA (SRB)

 ILIC SOFIJA (BIH)
041 Kanku Sho

1. SKRBIC SARA (SRB)
2. ILIC SOFIJA (BIH)
3. GULEN ECRIN (TUR)
3. RADULOVIC ANJA (MNE)
5. UZUNESER MIHRINUR (TUR)
5. PAPACHRISTOU EVGENIA (GRE)
7. SHABANOVIQ IRSI (MNE)
7. MUTLUOGLU RABIA (TUR)

Referees:			

11 Yrs Kata Individual Female

30th Balkan Karate Championships for Children 2026 - Istanbul

2026-05-30

Tatami
3 12:25

Pool
1,2

(c)sportdata GmbH & Co KG 2000-2026 (2026-05-31 14:44) v 12.2.0 build 1 (2026-05-24 19:07 CET) License: Lazar Piper SRB (expire 2027-01-23)

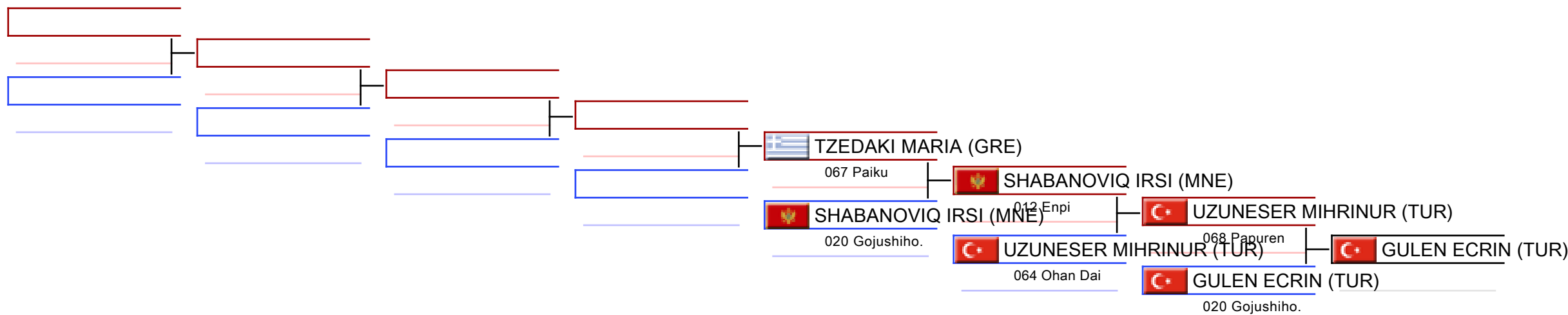

REPECHAGE: (1,2)

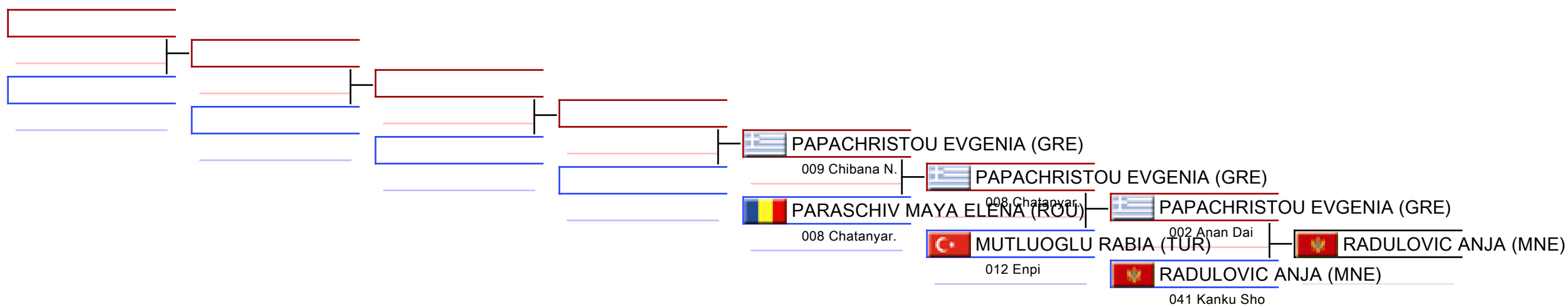

Referees:							
-----------	--	--	--	--	--	--	--

11 Yrs Kata Individual Male

30th Balkan Karate Championships for Children 2026 - Istanbul, Basaksehir Spor Hall, Kayabaşı, TINAZTEPE CADDESİ NO:6, 34494 Başakşehir, İstanbul, TUR2026-05-29

Tatami

3 09:00

Pool

1/2

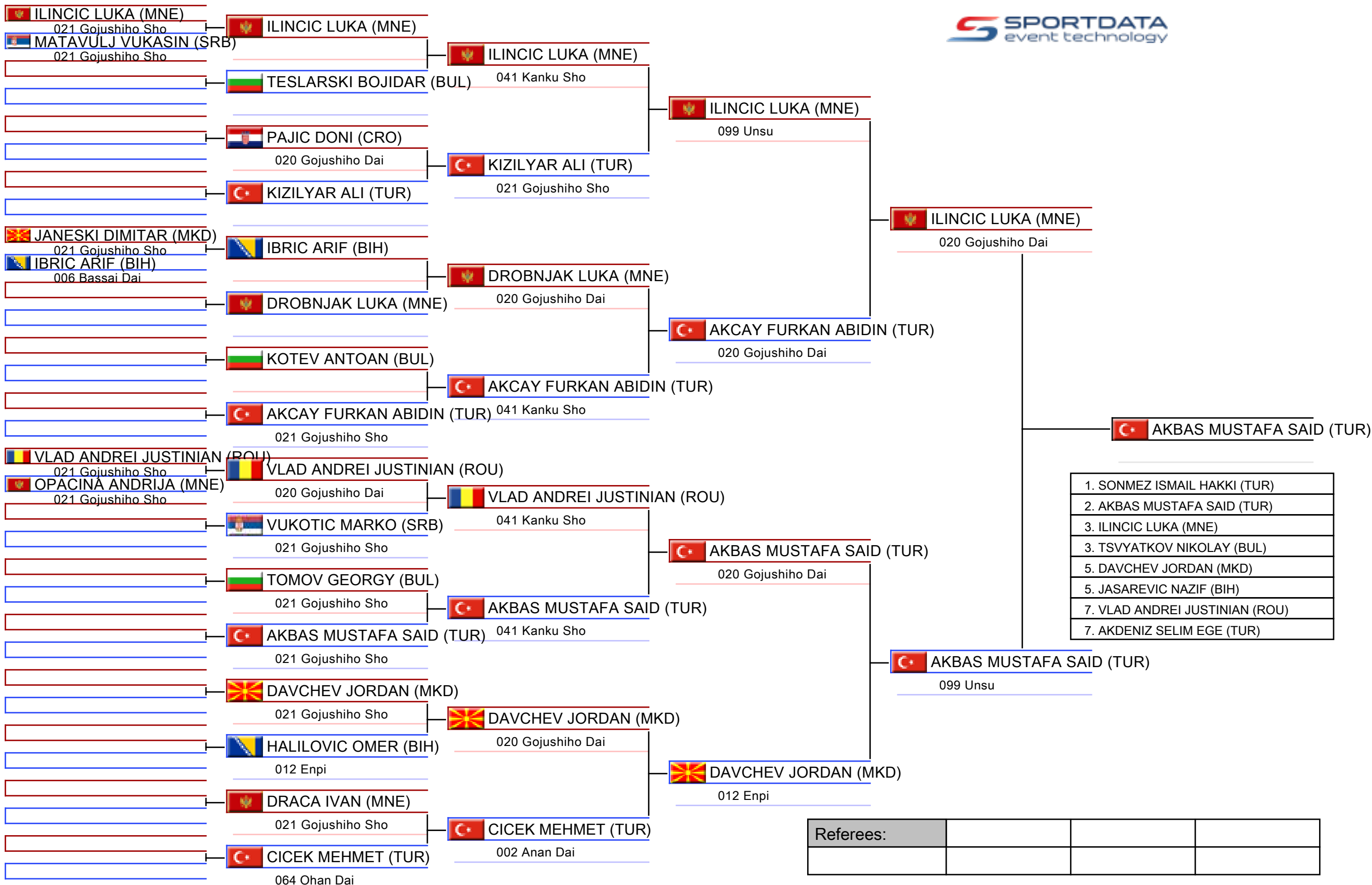

11 Yrs Kata Individual Male

30th Balkan Karate Championships for Children 2026 - Istanbul, Basaksehir Spor Hall, Kayabaşı, TINAZTEPE CADDESİ NO:6, 34494 Başakşehir, İstanbul, TUR2026-05-29

Tatami

3 10:30

Pool

2/2

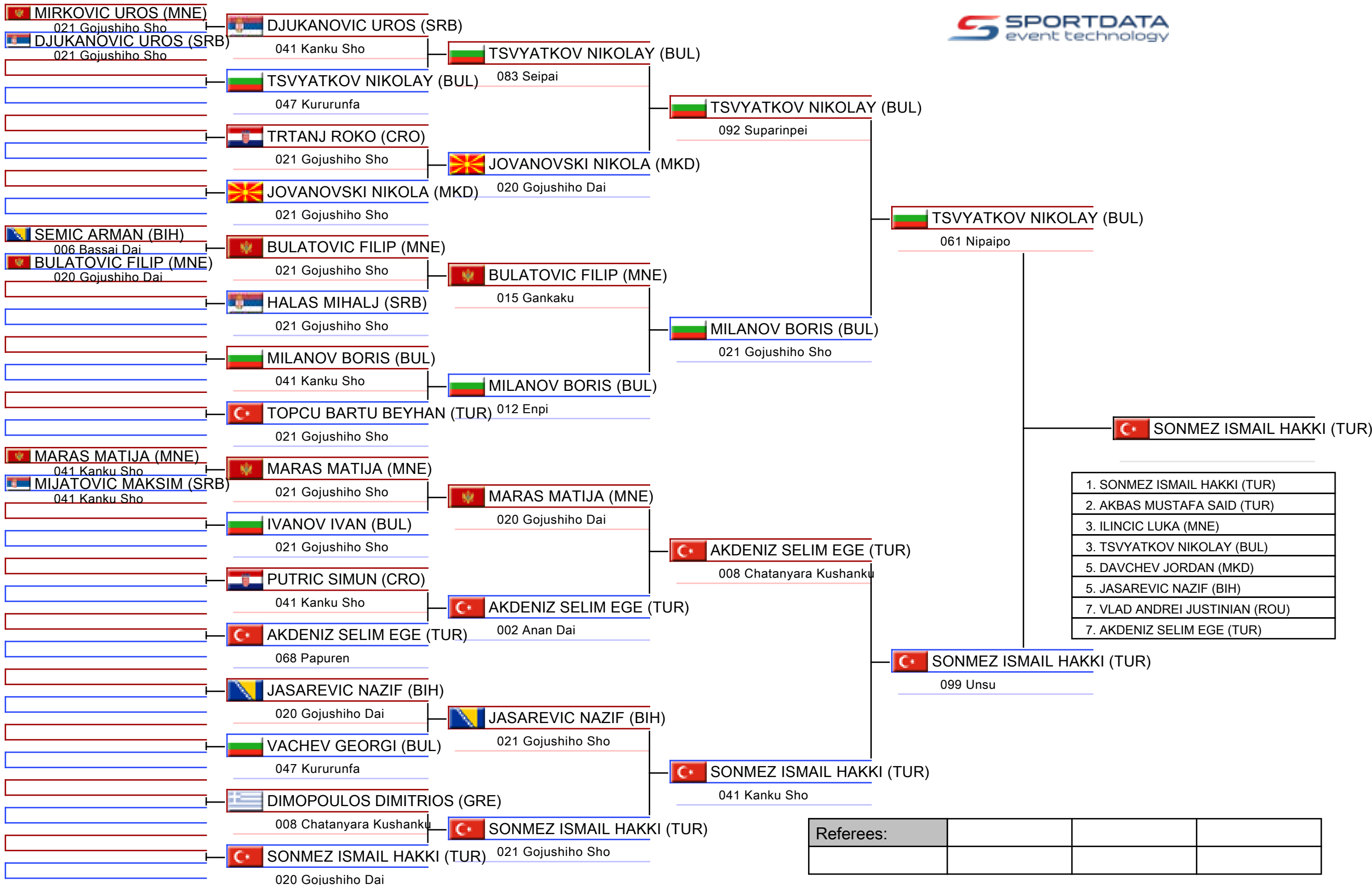

Pool winner-11 Yrs Kata Individual Male

30th Balkan Karate Championships for Children 2026 - Istanbul, Basaksehir Spor Hall, Kayabaşı, TINAZTEPE CADDESİ NO:6, 34494 Başakşehir, İstanbul, TUR

Tatami

Pool
1/1



Final

AKBAS MUSTAFA SAID (TUR)

020 Gojushiho Dai

SONMEZ ISMAIL HAKKI (TUR)

SONMEZ ISMAIL HAKKI (TUR)

041 Kanku Sho

1. SONMEZ ISMAIL HAKKI (TUR)
2. AKBAS MUSTAFA SAID (TUR)
3. ILINCIC LUKA (MNE)
3. TSVYATKOV NIKOLAY (BUL)
5. DAVCHEV JORDAN (MKD)
5. JASAREVIC NAZIF (BIH)
7. VLAD ANDREI JUSTINIAN (ROU)
7. AKDENIZ SELIM EGE (TUR)

Referees:			

11 Yrs Kata Individual Male

30th Balkan Karate Championships for Children 2026 - Istanbul

2026-05-29

Tatami

3 12:00

Pool

1,2

(c)sportdata GmbH & Co KG 2000-2026 (2026-05-31 14:44) v 12.2.0 build 1 (2026-05-24 19:07 CET) License: Lazar Piper SRB (expire 2027-01-23)

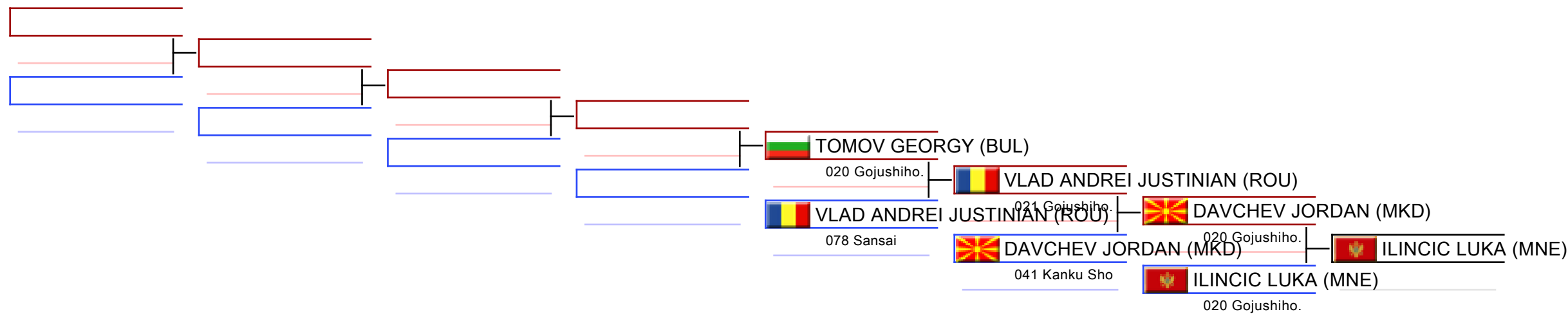

REPECHAGE: (1,2)

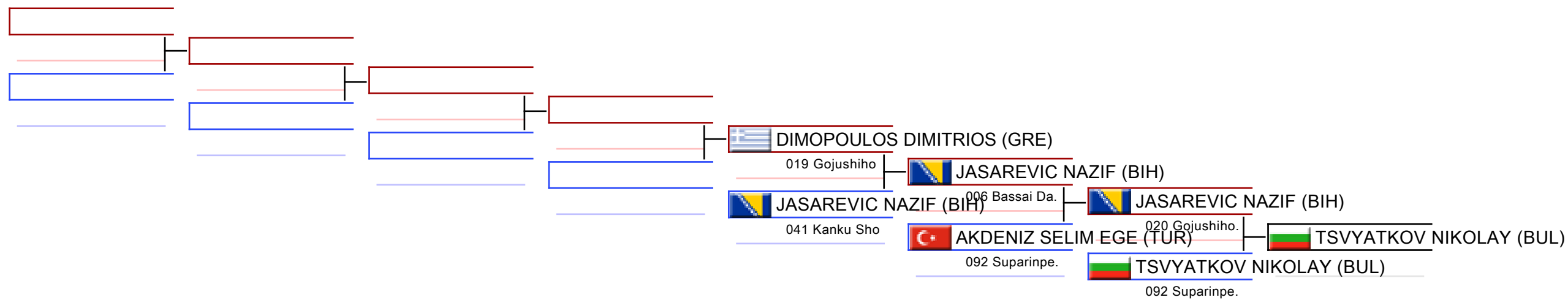

Referees:							
-----------	--	--	--	--	--	--	--

11 Yrs Kumite Female -32 kg

30th Balkan Karate Championships for Children 2026 - Istanbul, Basaksehir Spor Hall, Kayabaşı, TINAZTEPE CADDESİ NO:6, 34494 Başakşehir, İstanbul, TUR2026-05-29

Tatami

2 12:55

Pool

1/1

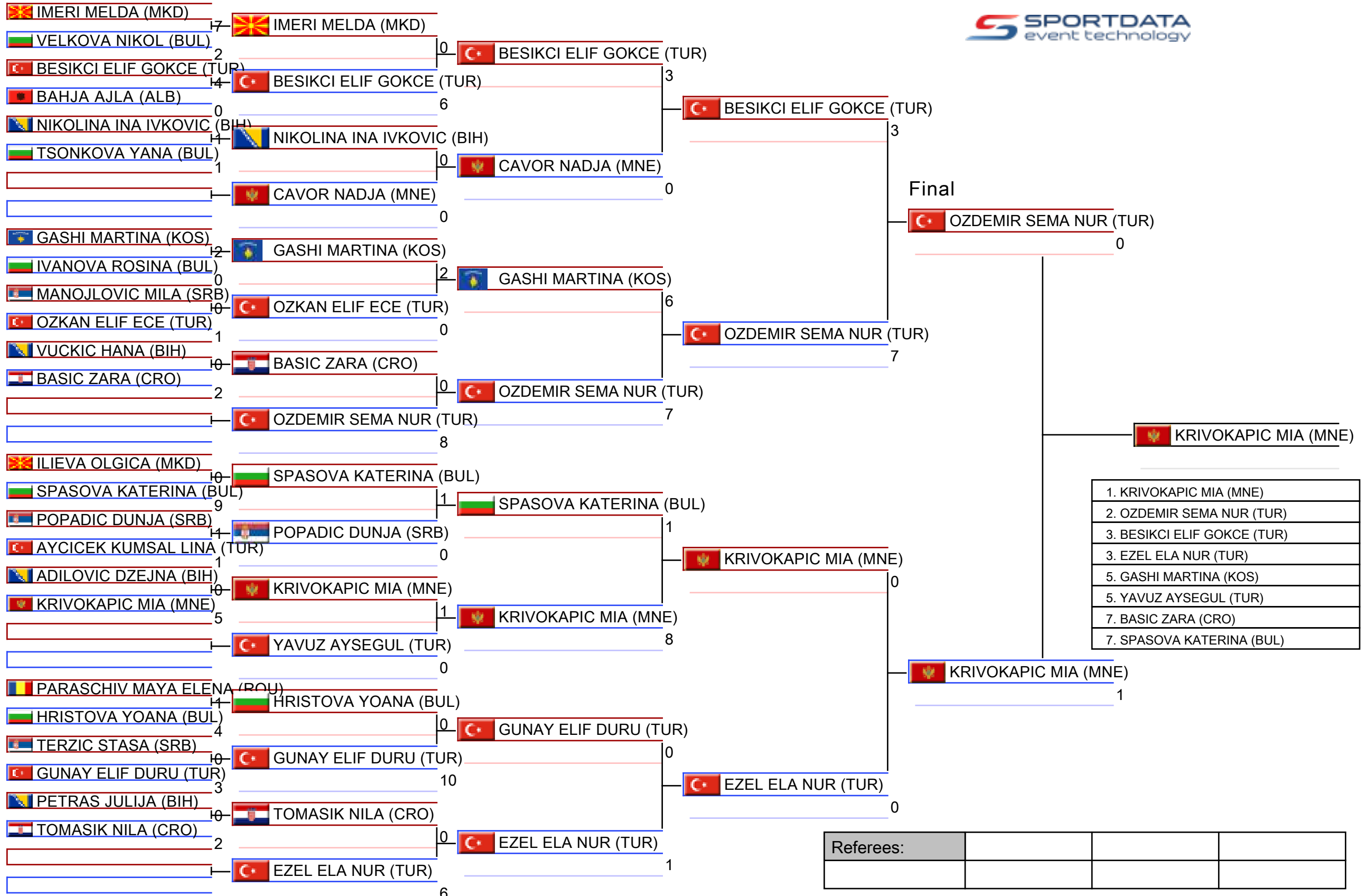

Referees:			

11 Yrs Kumite Female -32 kg

30th Balkan Karate Championships for Children 2026 - Istanbul

2026-05-29

Tatami
2 14:25

Pool
1

(c)sportdata GmbH & Co KG 2000-2026 (2026-05-31 14:44) v 12.2.0 build 1 (2026-05-24 19:07 CET) License: Lazar Piper SRB (expire 2027-01-23)

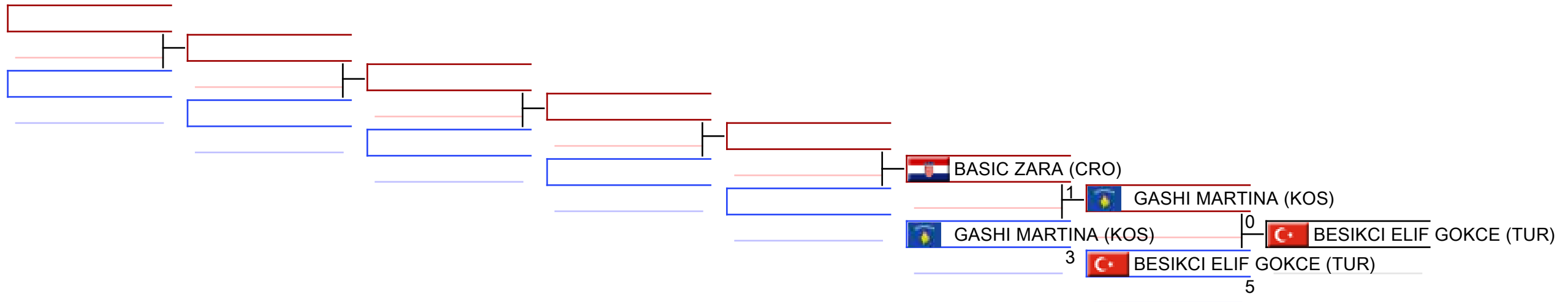

REPECHAGE: (1)

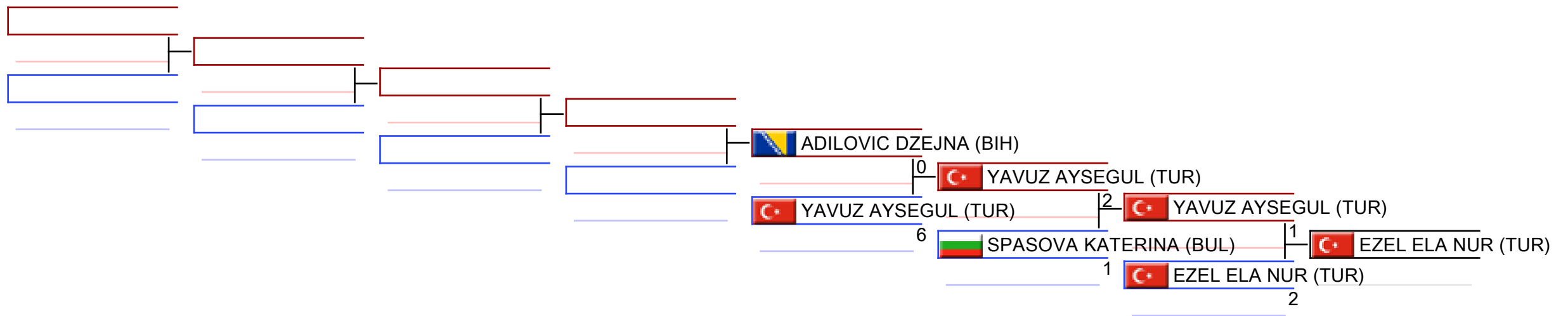

Referees:							
-----------	--	--	--	--	--	--	--

11 Yrs Kumite Female -36 kg

30th Balkan Karate Championships for Children 2026 - Istanbul, Basaksehir Spor Hall, Kayabaşı, TINAZTEPE CADDESİ NO:6, 34494 Başakşehir, İstanbul, TUR2026-05-31

Tatami

3 10:25

Pool

1/1

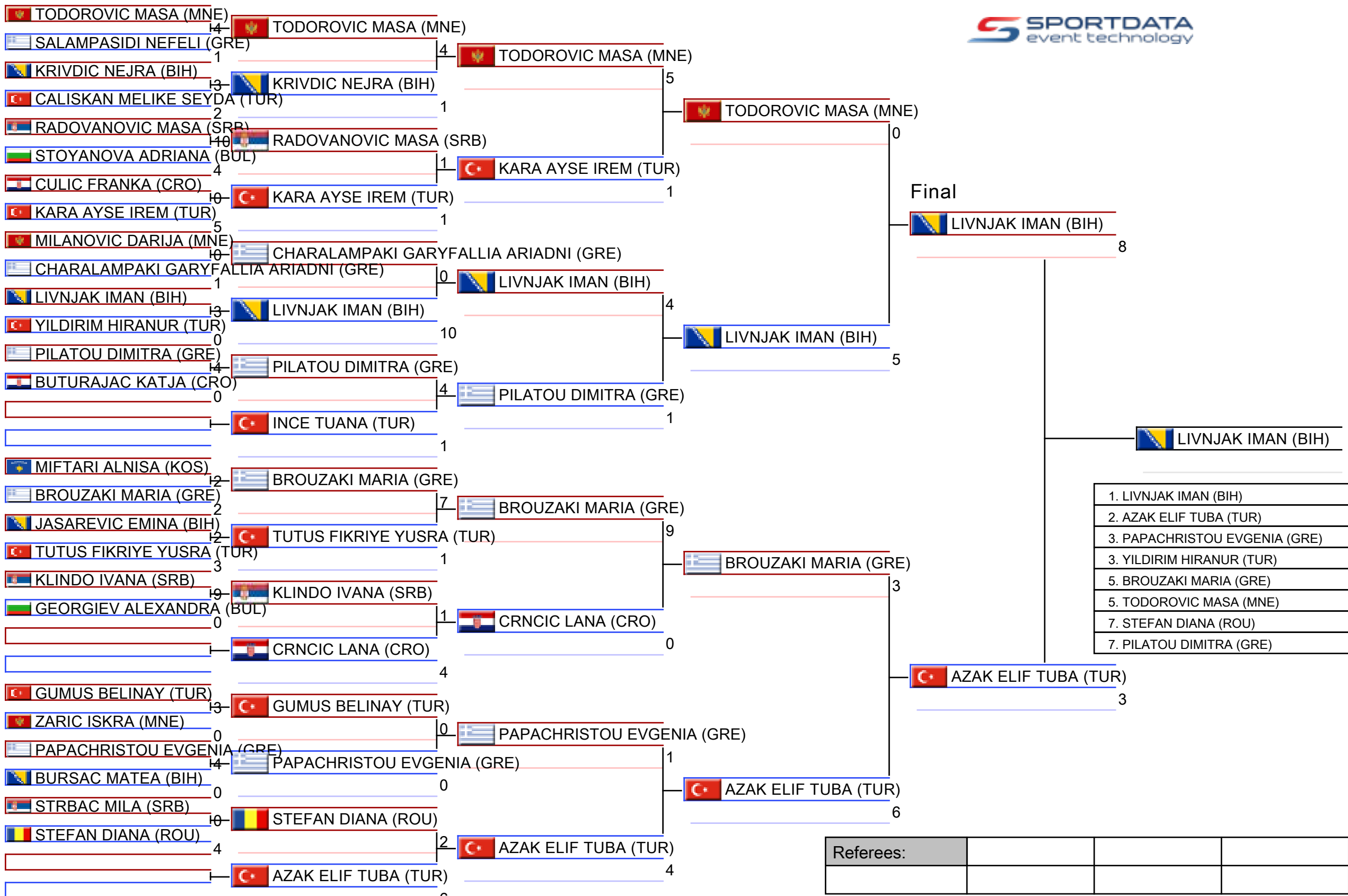

11 Yrs Kumite Female -36 kg

30th Balkan Karate Championships for Children 2026 - Istanbul

2026-05-31

Tatami
3 12:25

Pool
1

(c)sportdata GmbH & Co KG 2000-2026 (2026-05-31 14:44) v 12.2.0 build 1 (2026-05-24 19:07 CET) License: Lazar Piper SRB (expire 2027-01-23)

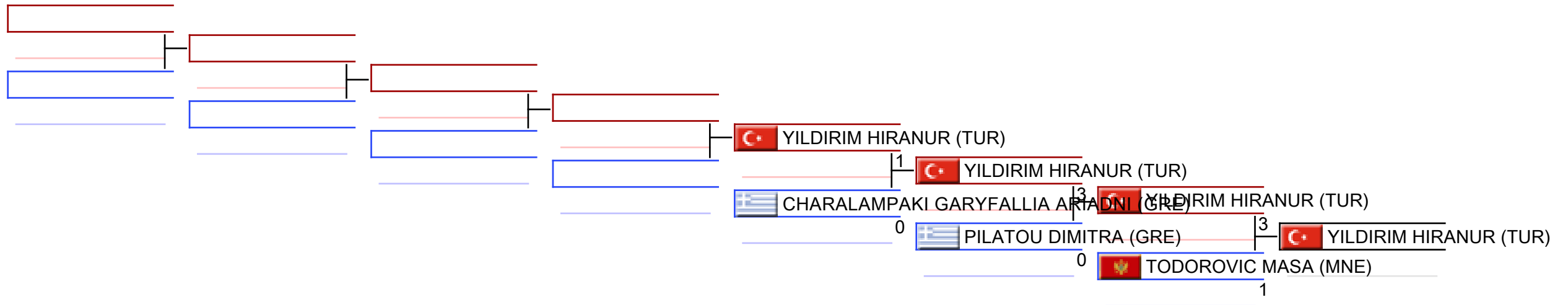

REPECHAGE: (1)

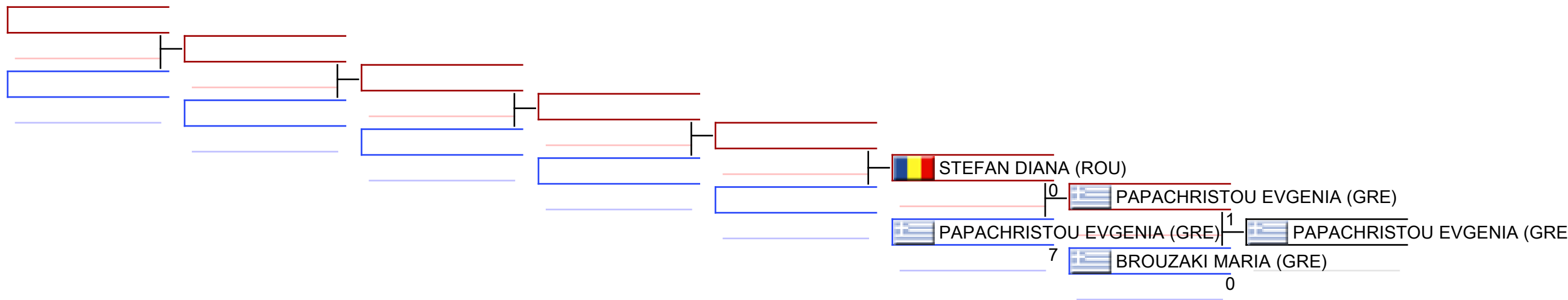

Referees:							
-----------	--	--	--	--	--	--	--

11 Yrs Kumite Female -40 kg

30th Balkan Karate Championships for Children 2026 - Istanbul, Basaksehir Spor Hall, Kayabaşı, TINAZTEPE CADDESİ NO:6, 34494 Başakşehir, İstanbul, TUR2026-05-29

Tatami

4 12:30

Pool

1/2

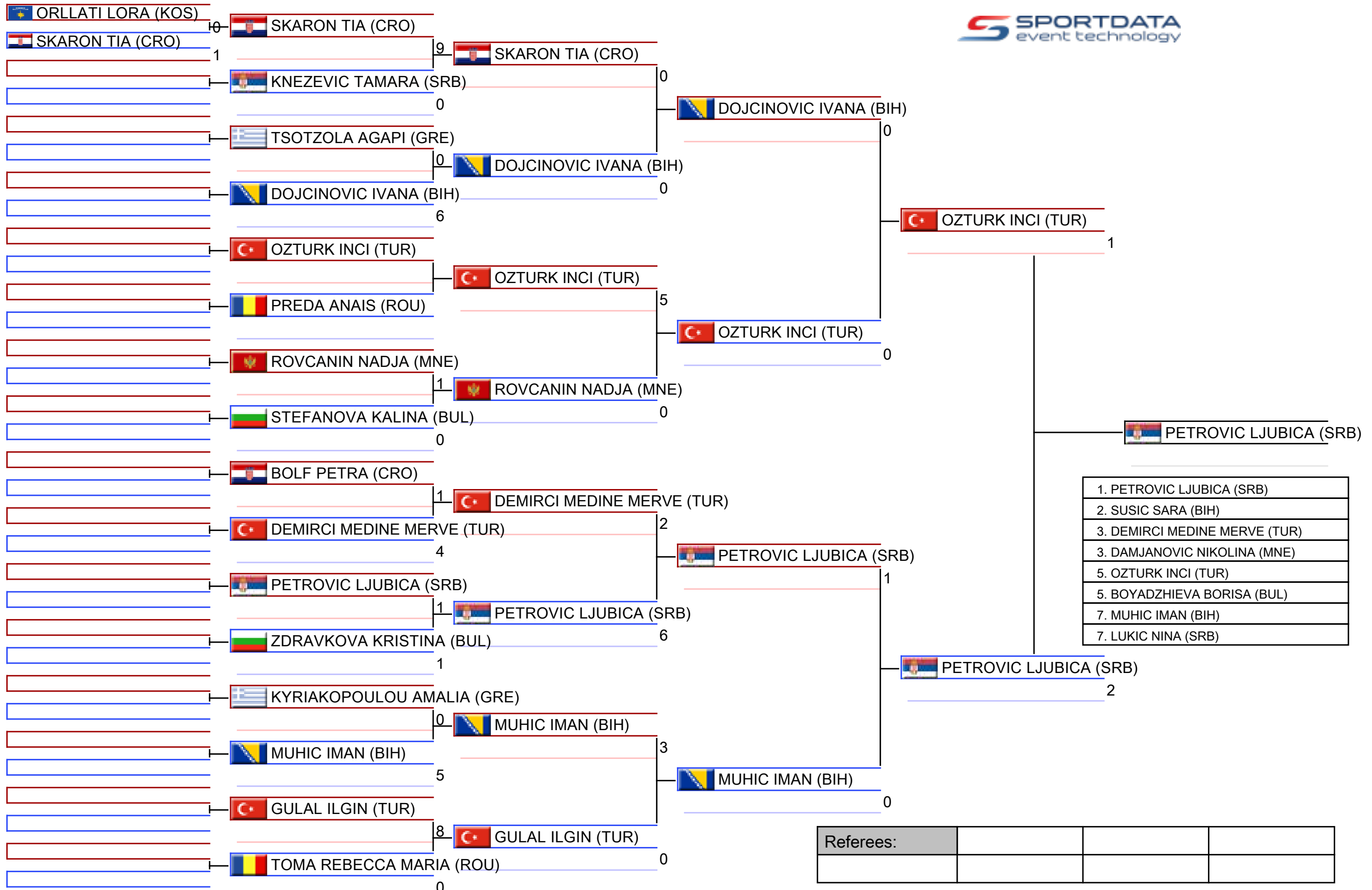

11 Yrs Kumite Female -40 kg

30th Balkan Karate Championships for Children 2026 - Istanbul, Basaksehir Spor Hall, Kayabaşı, TINAZTEPE CADDESİ NO:6, 34494 Başakşehir, İstanbul, TUR2026-05-29

Tatami

4 13:25

Pool

2/2

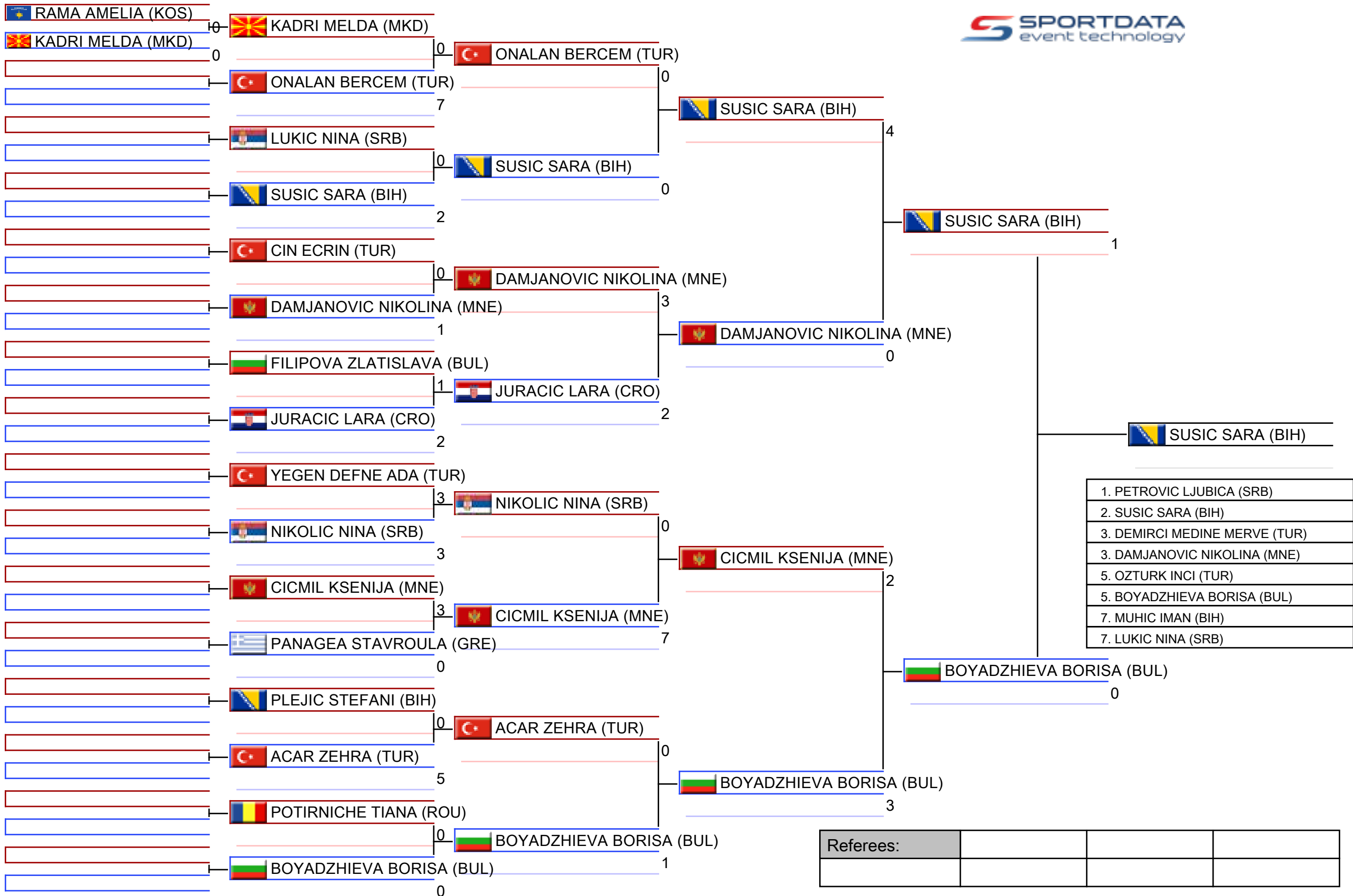

Referees:			

Pool winner-11 Yrs Kumite Female -40 kg

30th Balkan Karate Championships for Children 2026 - Istanbul, Basaksehir Spor Hall, Kayabaşı, TINAZTEPE CADDESİ NO:6, 34494 Başakşehir, İstanbul, TUR

Tatami

Pool

1/1

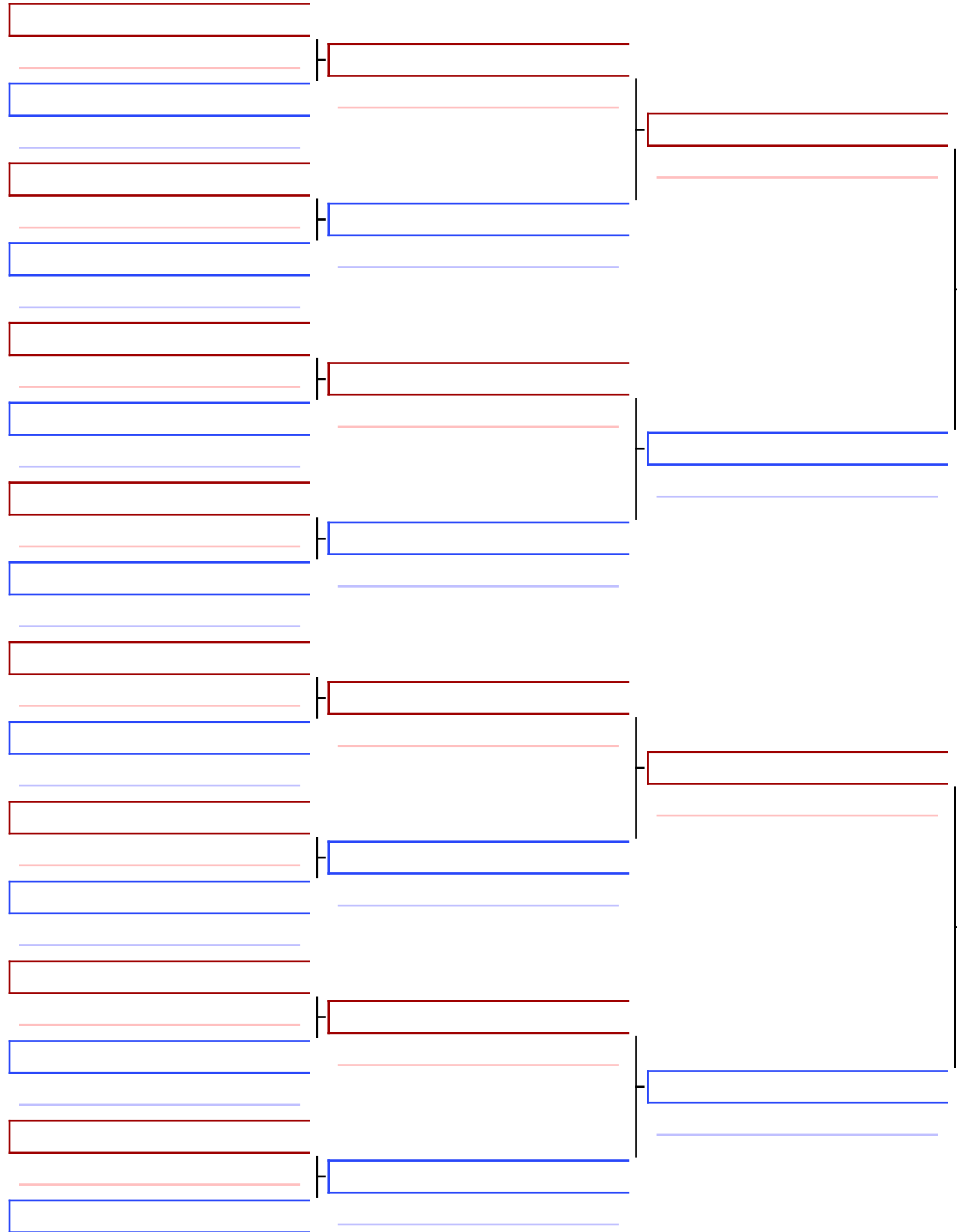

Final

PETROVIC LJUBICA (SRB)

4

PETROVIC LJUBICA (SRB)

SUSIC SARA (BIH)

1

- | |
|-------------------------------|
| 1. PETROVIC LJUBICA (SRB) |
| 2. SUSIC SARA (BIH) |
| 3. DEMIRCI MEDINE MERVE (TUR) |
| 3. DAMJANOVIC NIKOLINA (MNE) |
| 5. OZTURK INCI (TUR) |
| 5. BOYADZHIEVA BORISA (BUL) |
| 7. MUHIC IMAN (BIH) |
| 7. LUKIC NINA (SRB) |

Referees:			

11 Yrs Kumite Female -40 kg

30th Balkan Karate Championships for Children 2026 - Istanbul

2026-05-29

Tatami
4 14:20

Pool
1,2

(c)sportdata GmbH & Co KG 2000-2026 (2026-05-31 14:44) v 12.2.0 build 1 (2026-05-24 19:07 CET) License: Lazar Piper SRB (expire 2027-01-23)

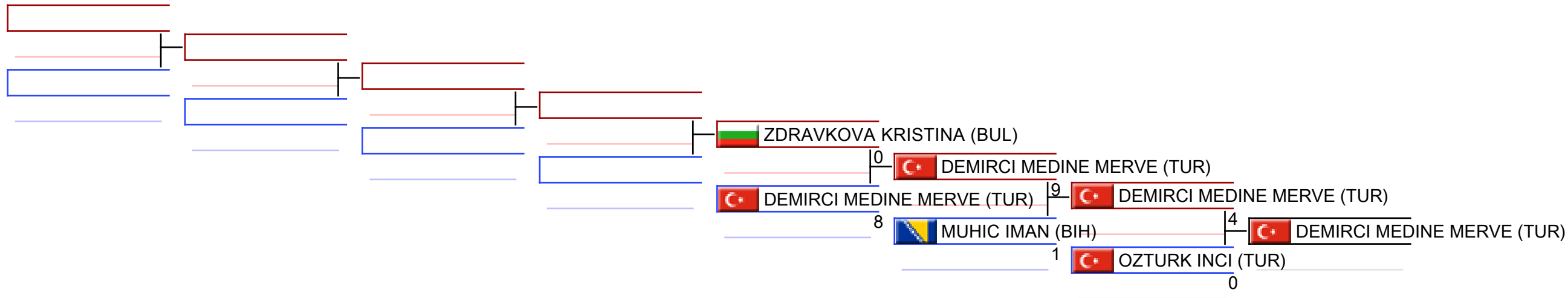

REPECHAGE: (1,2)

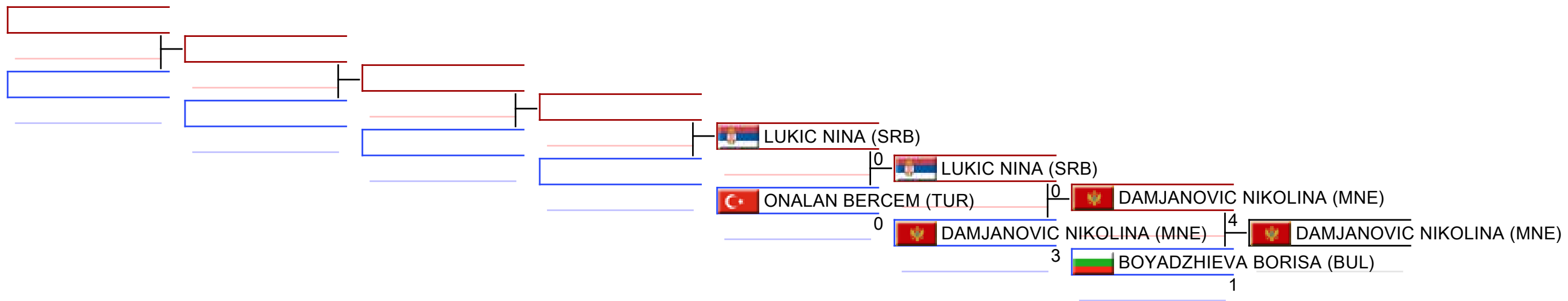

Referees:							
-----------	--	--	--	--	--	--	--

11 Yrs Kumite Female -44 kg

30th Balkan Karate Championships for Children 2026 - Istanbul, Basaksehir Spor Hall, Kayabaşı, TINAZTEPE CADDESİ NO:6, 34494 Başakşehir, İstanbul, TUR2026-05-31

Tatami

3 12:55

Pool

1/1

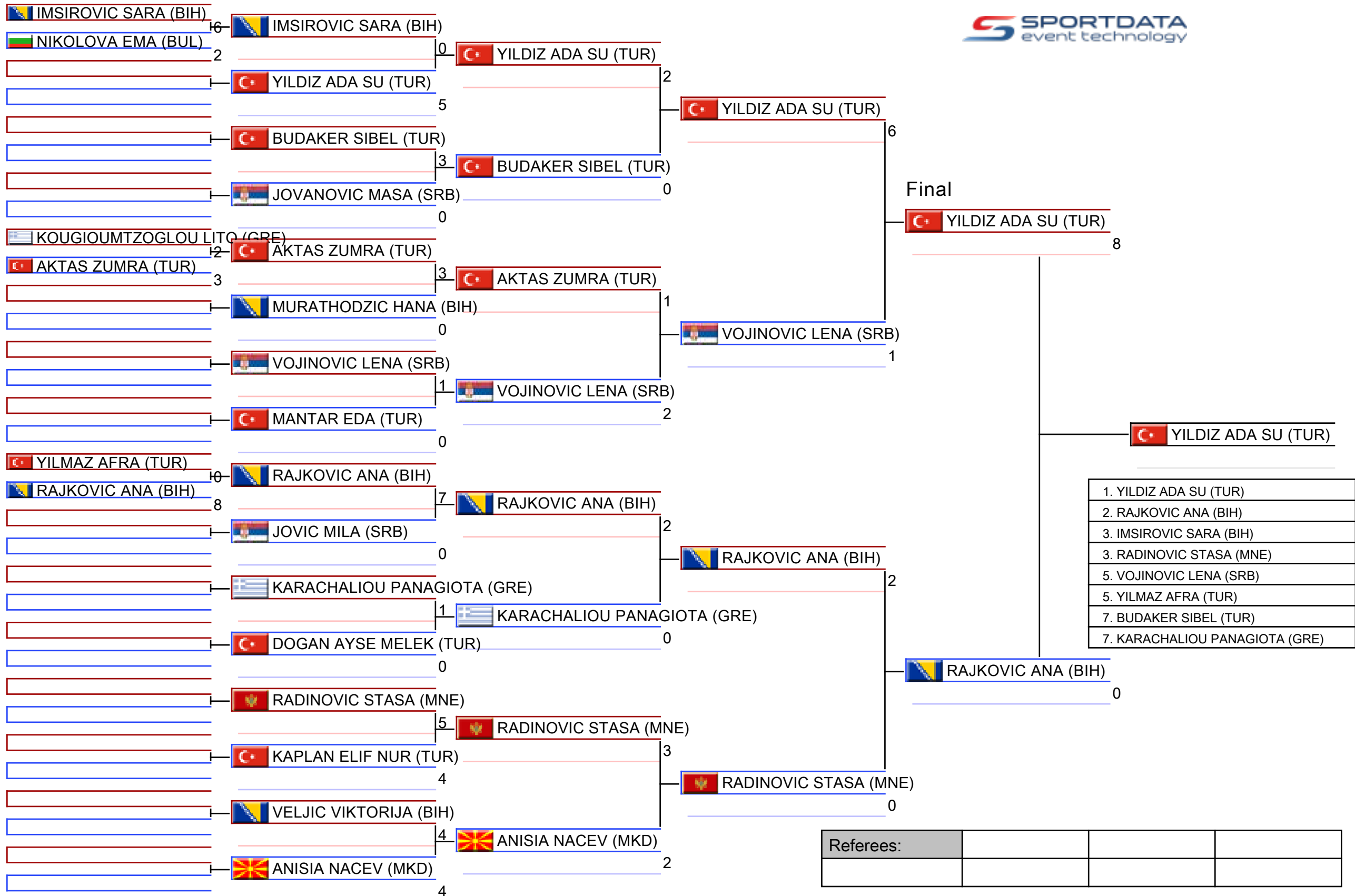

11 Yrs Kumite Female -44 kg

30th Balkan Karate Championships for Children 2026 - Istanbul

2026-05-31

Tatami
3 13:55

Pool
1

(c)sportdata GmbH & Co KG 2000-2026 (2026-05-31 14:44) v 12.2.0 build 1 (2026-05-24 19:07 CET) License: Lazar Piper SRB (expire 2027-01-23)

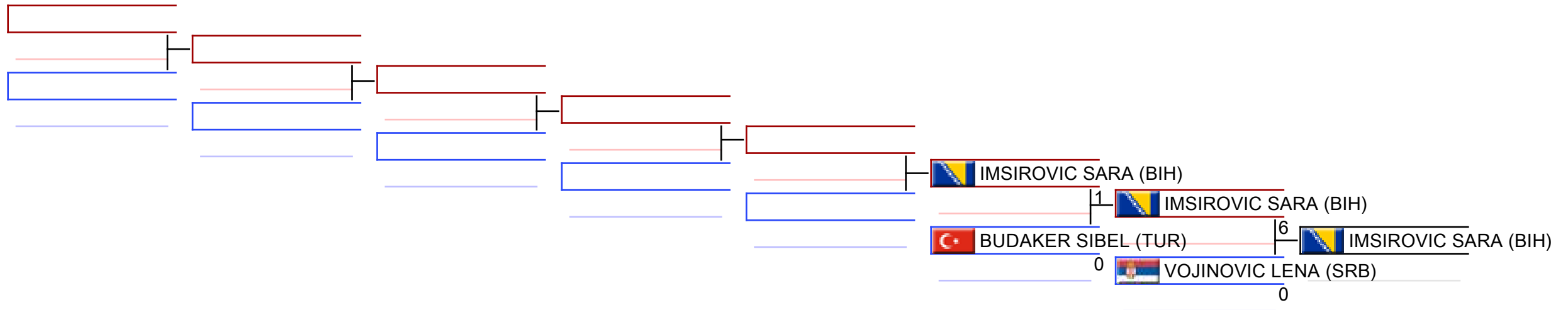

REPECHAGE: (1)

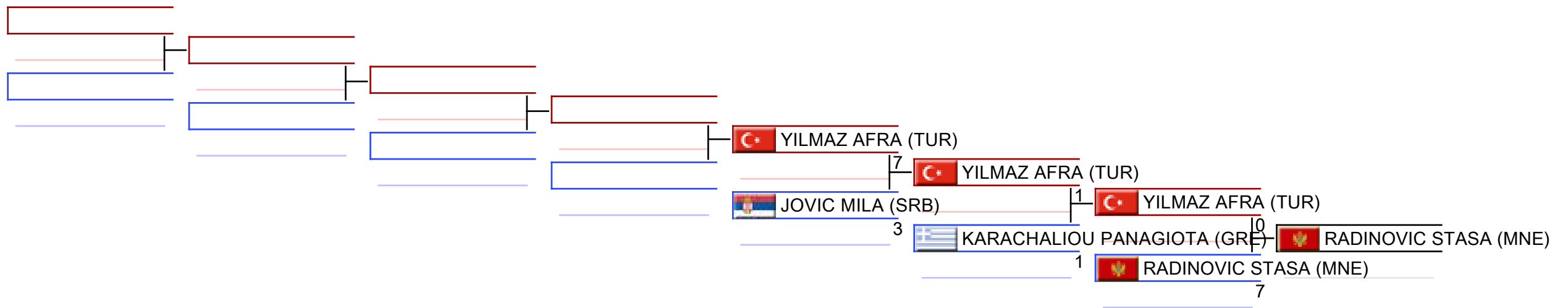

Referees:							
-----------	--	--	--	--	--	--	--

11 Yrs Kumite Female 44+ kg

30th Balkan Karate Championships for Children 2026 - Istanbul, Basaksehir Spor Hall, Kayabaşı, TINAZTEPE CADDESİ NO:6, 34494 Başakşehir, İstanbul, TUR2026-05-29

Tatami
4 15:45

Pool
1/1

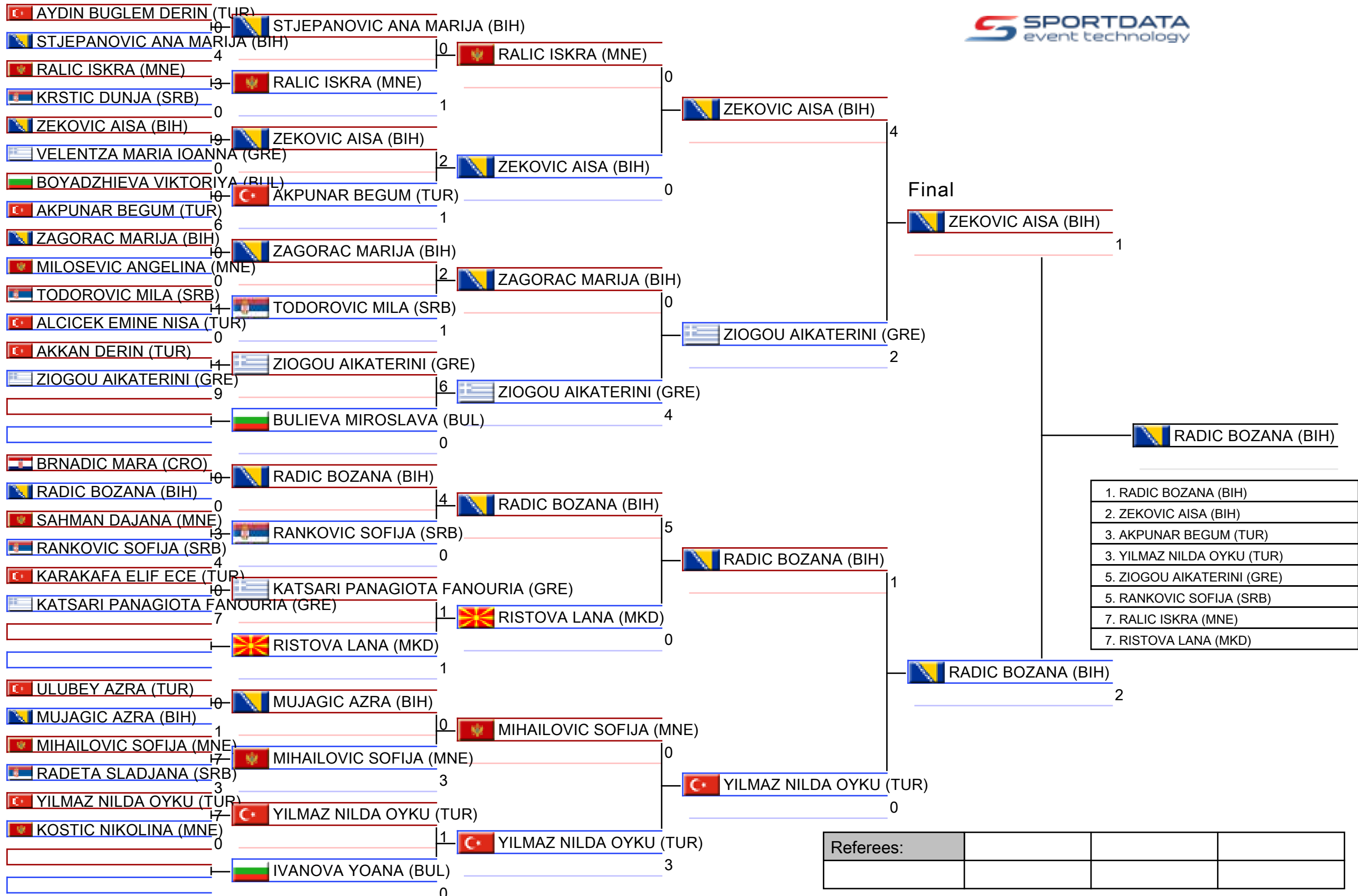

Referees:			

11 Yrs Kumite Female 44+ kg

30th Balkan Karate Championships for Children 2026 - Istanbul

2026-05-29

Tatami
4 17:20

Pool
1

(c)sportdata GmbH & Co KG 2000-2026 (2026-05-31 14:44) v 12.2.0 build 1 (2026-05-24 19:07 CET) License: Lazar Piper SRB (expire 2027-01-23)

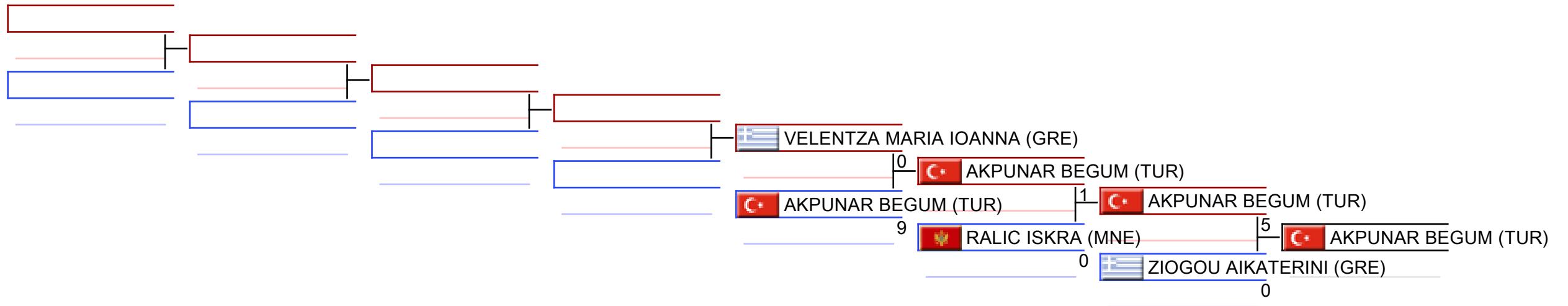

REPECHAGE: (1)

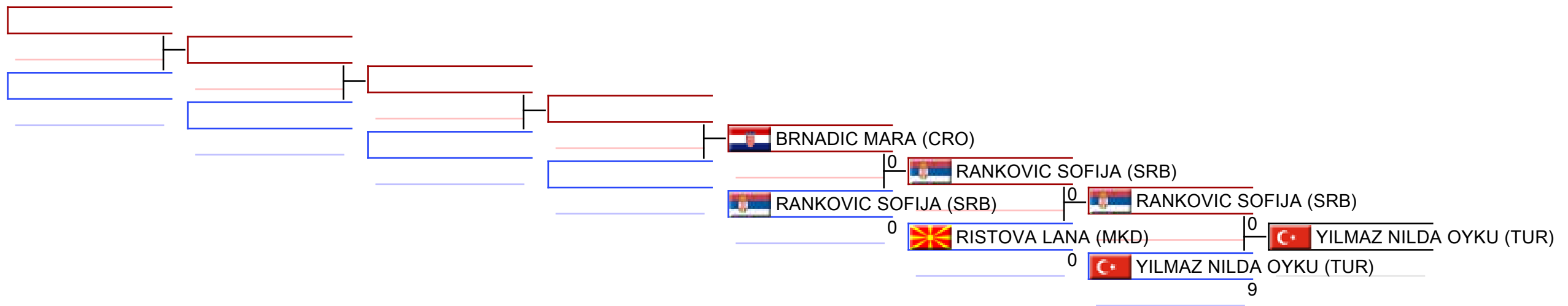

Referees:							
-----------	--	--	--	--	--	--	--

11 Yrs Kumite Male -35 kg

30th Balkan Karate Championships for Children 2026 - Istanbul, Basaksehir Spor Hall, Kayabaşı, TINAZTEPE CADDESİ NO:6, 34494 Başakşehir, İstanbul, TUR2026-05-30

Tatami

5 14:00

Pool

1/2

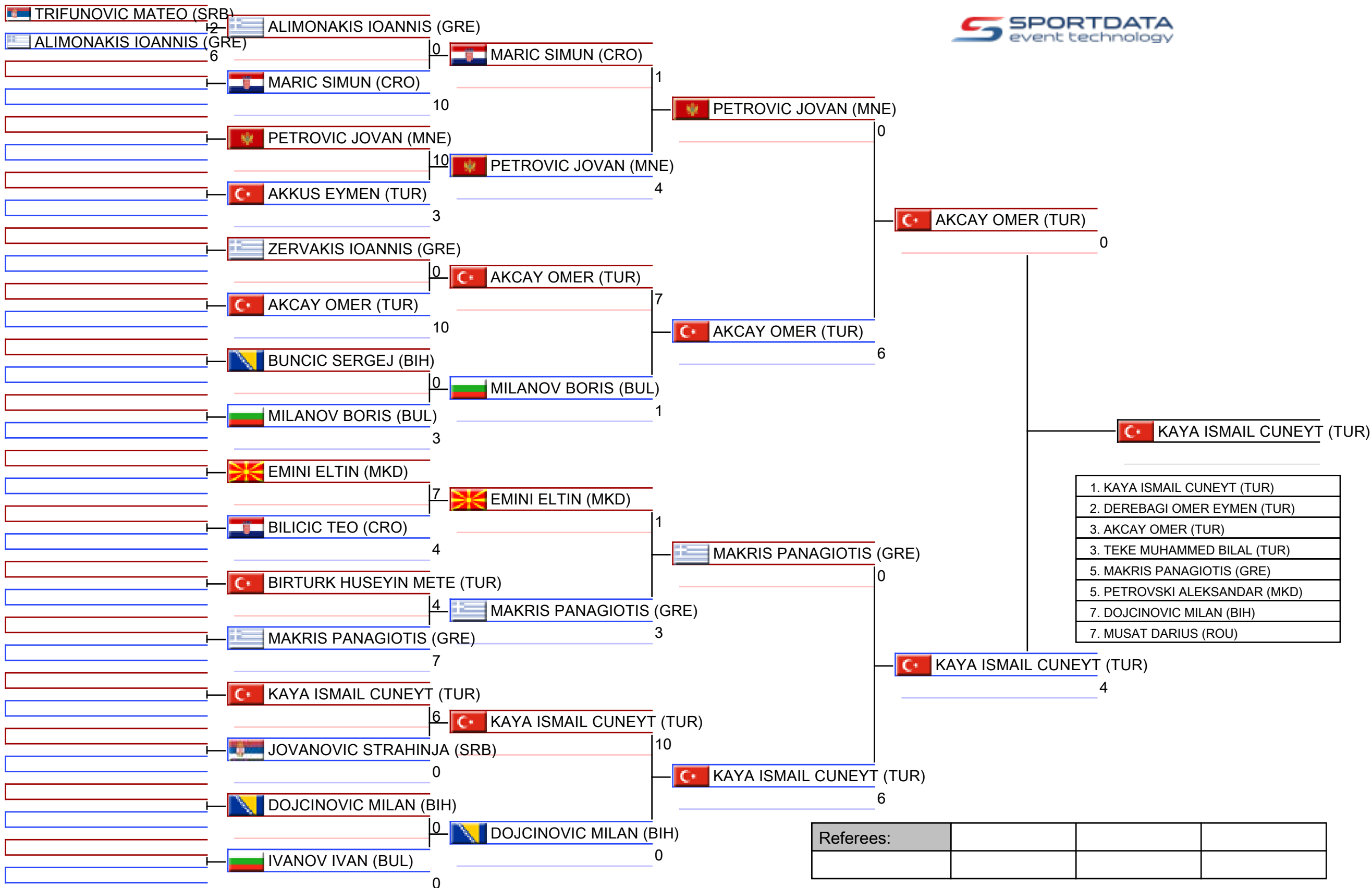

11 Yrs Kumite Male -35 kg

30th Balkan Karate Championships for Children 2026 - Istanbul, Basaksehir Spor Hall, Kayabaşı, TINAZTEPE CADDESİ NO:6, 34494 Başakşehir, İstanbul, TUR2026-05-30

Tatami

5 14:55

Pool

2/2

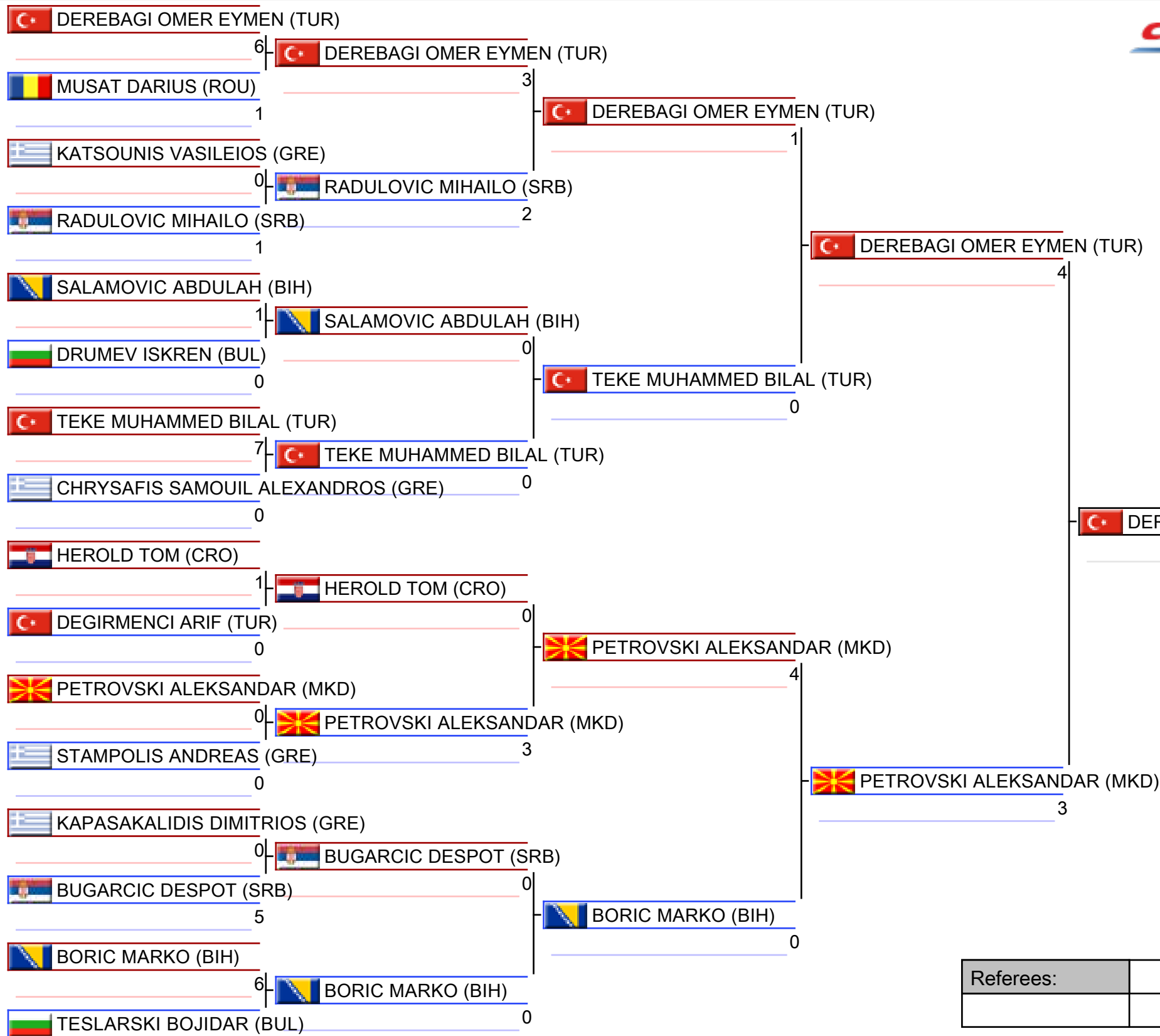

1. KAYA ISMAIL CUNEYT (TUR)
2. DEREBAGI OMER EYMEN (TUR)
3. AKCAY OMER (TUR)
3. TEKE MUHAMMED BILAL (TUR)
5. MAKRIS PANAGIOTIS (GRE)
5. PETROVSKI ALEKSANDAR (MKD)
7. DOJCINOVIC MILAN (BIH)
7. MUSAT DARIUS (ROU)

Referees:			

Pool winner-11 Yrs Kumite Male -35 kg

30th Balkan Karate Championships for Children 2026 - Istanbul, Basaksehir Spor Hall, Kayabaşı, TINAZTEPE CADDESİ NO:6, 34494 Başakşehir, İstanbul, TUR

Tatami

Pool
1/1



Final

KAYA ISMAIL CUNEYT (TUR)

0

KAYA ISMAIL CUNEYT (TUR)

DEREBAGI OMER EYMEN (TUR)

0

1. KAYA ISMAIL CUNEYT (TUR)
2. DEREBAGI OMER EYMEN (TUR)
3. AKCAY OMER (TUR)
3. TEKE MUHAMMED BILAL (TUR)
5. MAKRIS PANAGIOTIS (GRE)
5. PETROVSKI ALEKSANDAR (MKD)
7. DOJCINOVIC MILAN (BIH)
7. MUSAT DARIUS (ROU)

Referees:			

11 Yrs Kumite Male -35 kg

30th Balkan Karate Championships for Children 2026 - Istanbul

2026-05-30

Tatami
5 15:50

Pool
1,2

(c)sportdata GmbH & Co KG 2000-2026 (2026-05-31 14:44) v 12.2.0 build 1 (2026-05-24 19:07 CET) License: Lazar Piper SRB (expire 2027-01-23)

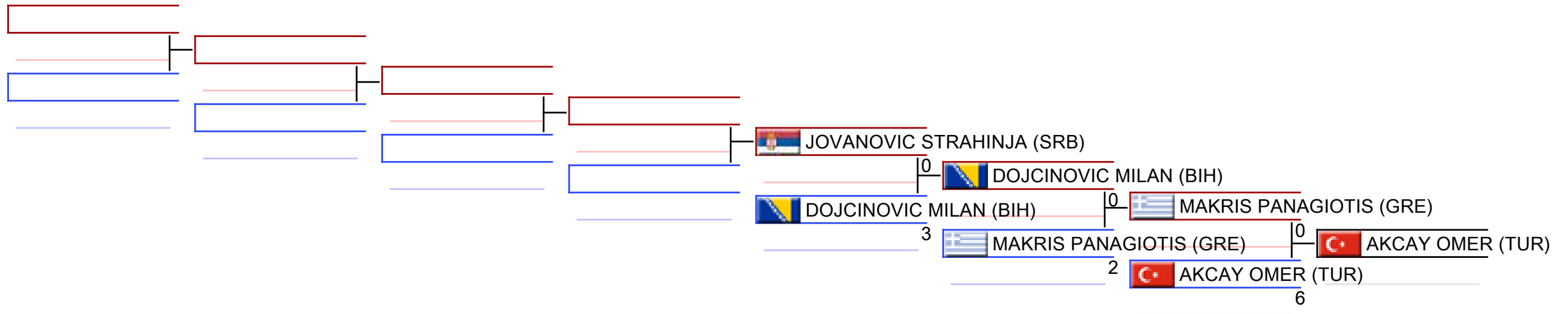

REPECHAGE: (1,2)

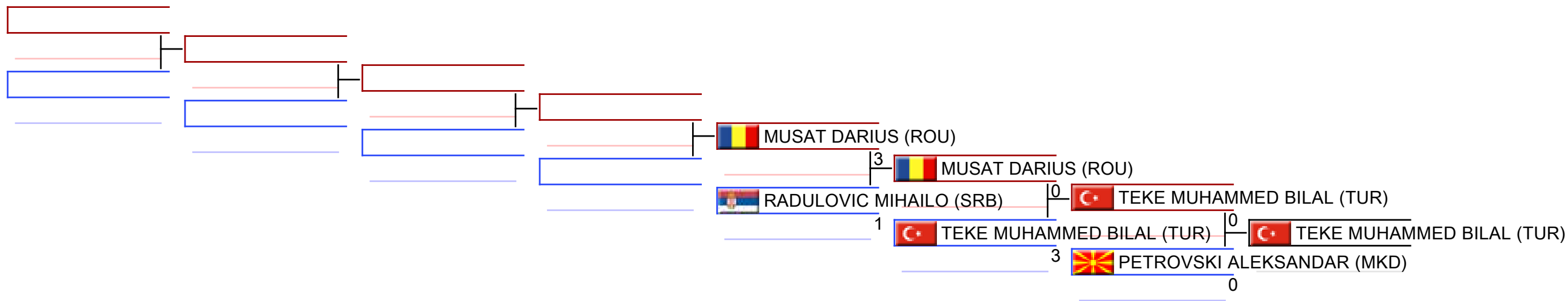

Referees:							
-----------	--	--	--	--	--	--	--

11 Yrs Kumite Male -40 kg

30th Balkan Karate Championships for Children 2026 - Istanbul, Basaksehir Spor Hall, Kayabaşı, TINAZTEPE CADDESİ NO:6, 34494 Başakşehir, İstanbul, TUR2026-05-30

Tatami

6 16:20

Pool

1/2

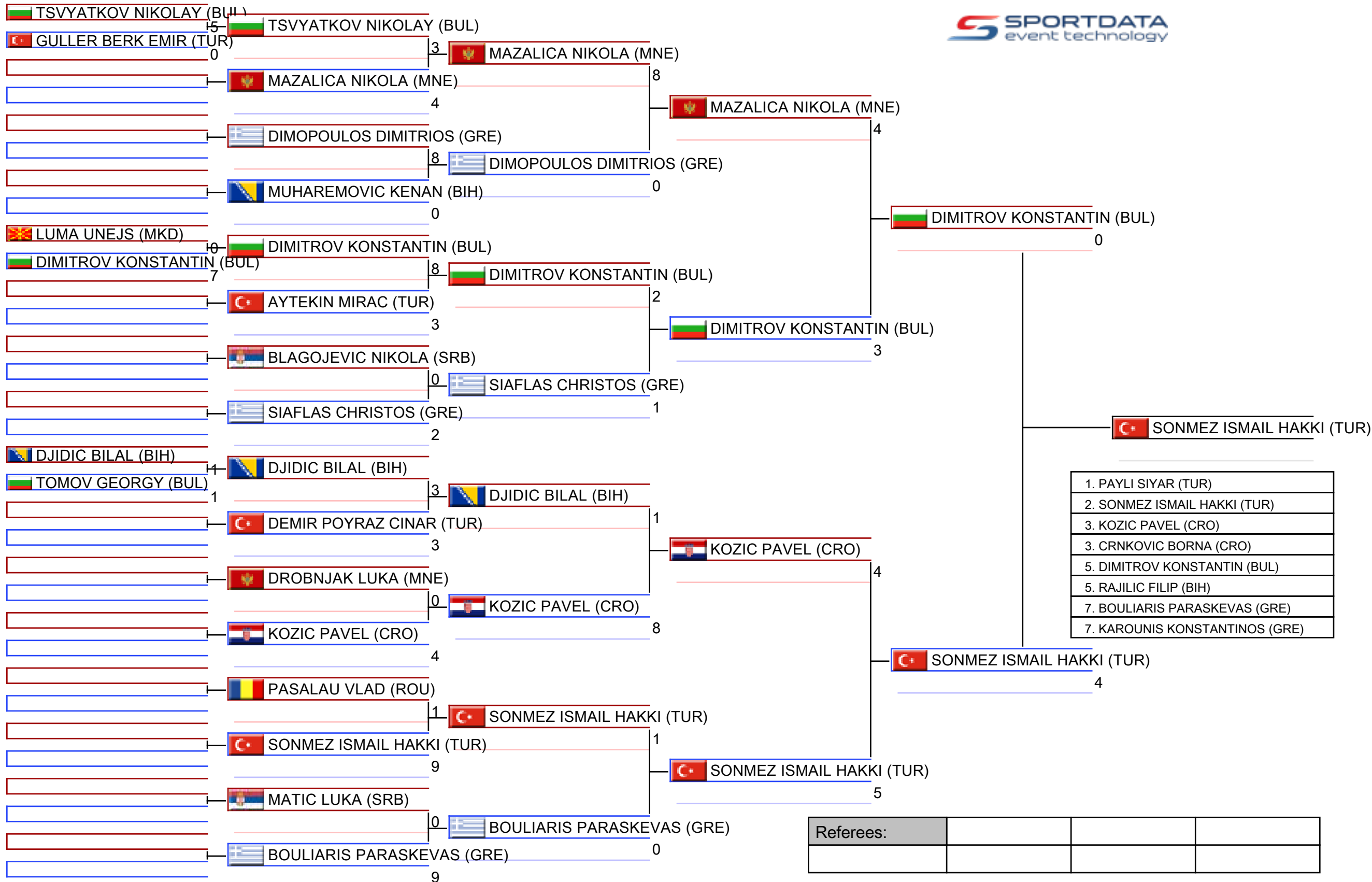

11 Yrs Kumite Male -40 kg

30th Balkan Karate Championships for Children 2026 - Istanbul, Basaksehir Spor Hall, Kayabaşı, TINAZTEPE CADDESİ NO:6, 34494 Başakşehir, İstanbul, TUR2026-05-30

Tatami
6 17:25

Pool
2/2

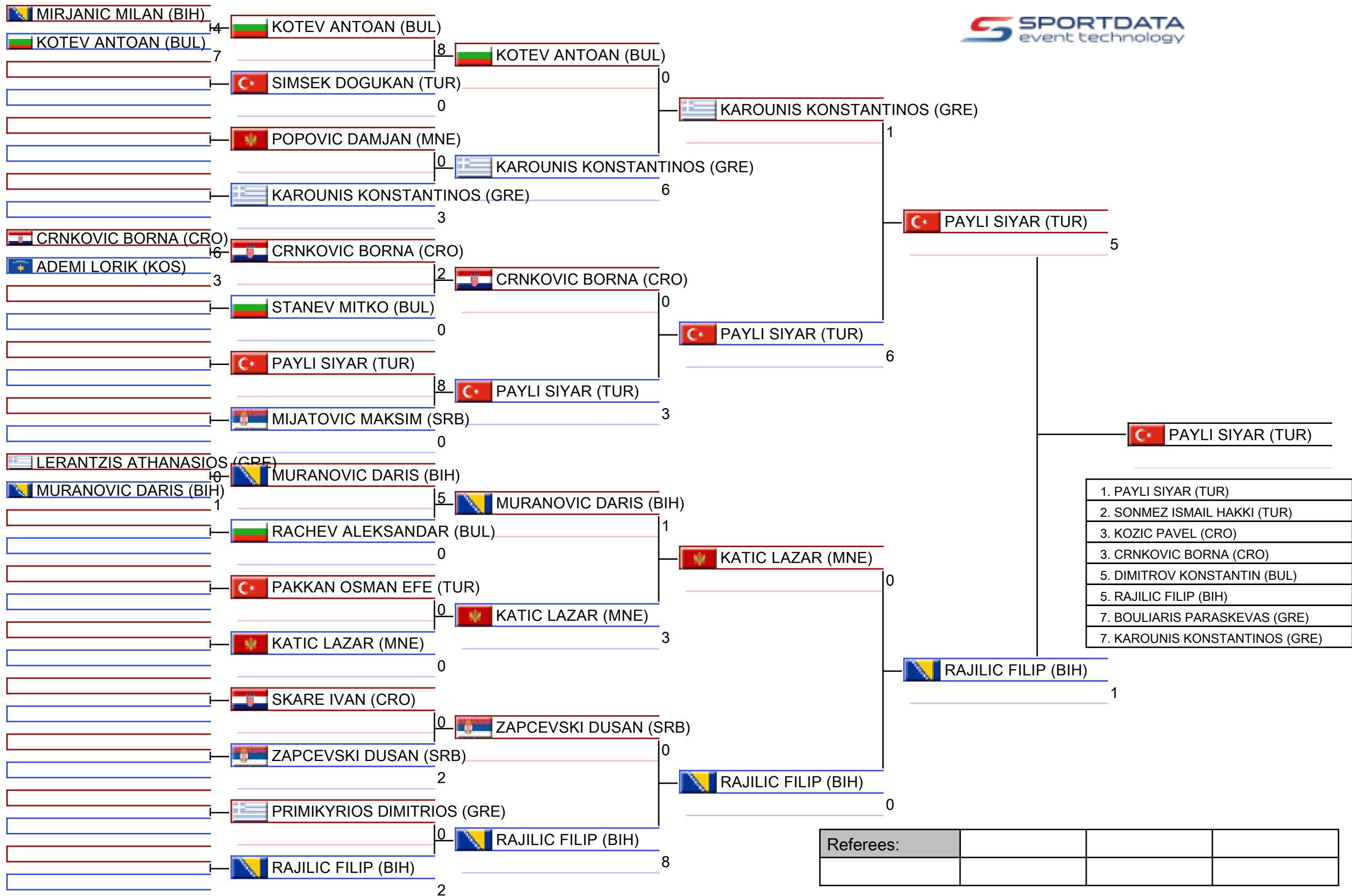

Pool winner-11 Yrs Kumite Male -40 kg

30th Balkan Karate Championships for Children 2026 - Istanbul, Basaksehir Spor Hall, Kayabaşı, TINAZTEPE CADDESİ NO:6, 34494 Başakşehir, İstanbul, TUR

Tatami

Pool
1/1

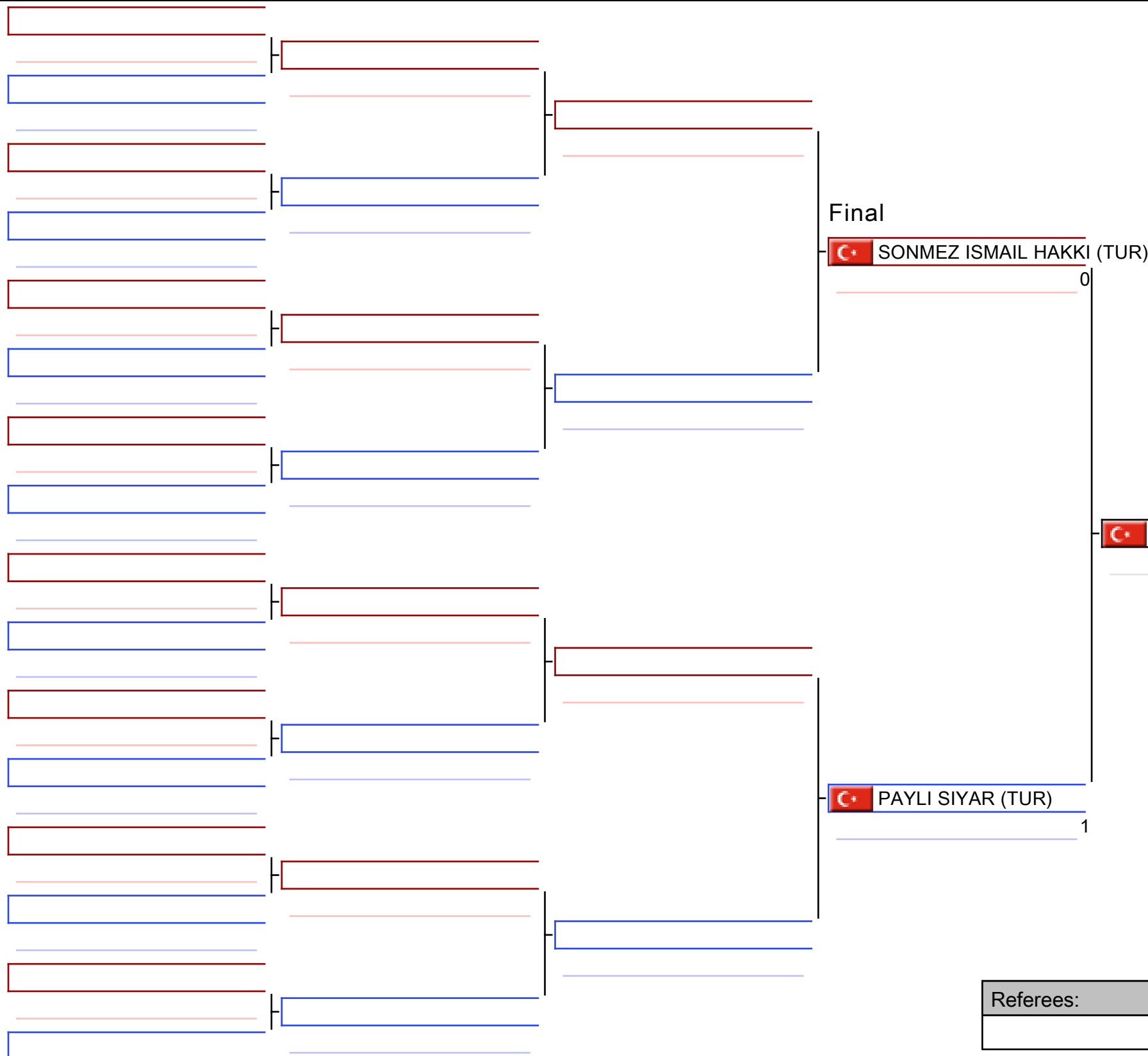

1. PAYLI SIYAR (TUR)
2. SONMEZ ISMAIL HAKKI (TUR)
3. KOZIC PAVEL (CRO)
3. CRNKOVIC BORNA (CRO)
5. DIMITROV KONSTANTIN (BUL)
5. RAJILIC FILIP (BIH)
7. BOULIARIS PARASKEVAS (GRE)
7. KAROUNIS KONSTANTINOS (GRE)

Referees:			

11 Yrs Kumite Male -40 kg

30th Balkan Karate Championships for Children 2026 - Istanbul

2026-05-30

Tatami
6 18:30

Pool
1

(c)sportdata GmbH & Co KG 2000-2026 (2026-05-31 14:44) v 12.2.0 build 1 (2026-05-24 19:07 CET) License: Lazar Piper SRB (expire 2027-01-23)

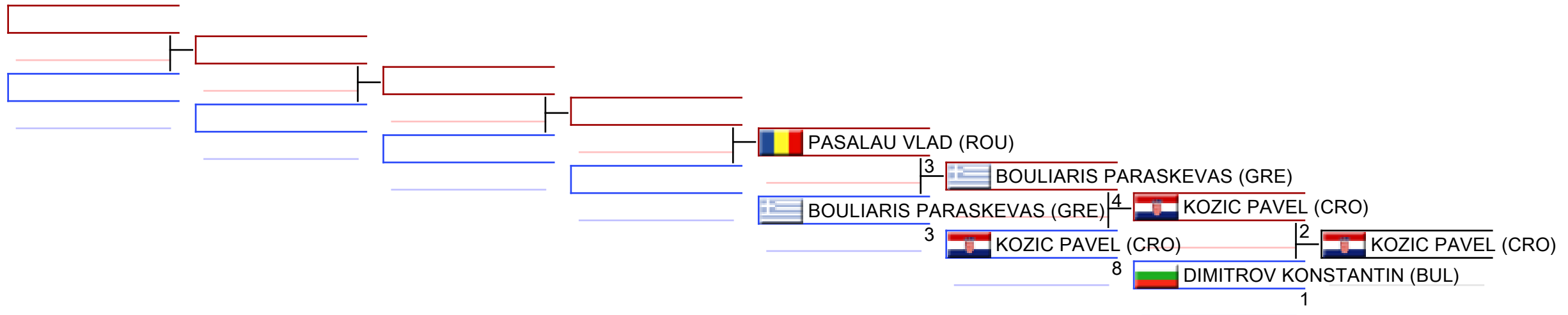

REPECHAGE: (1)

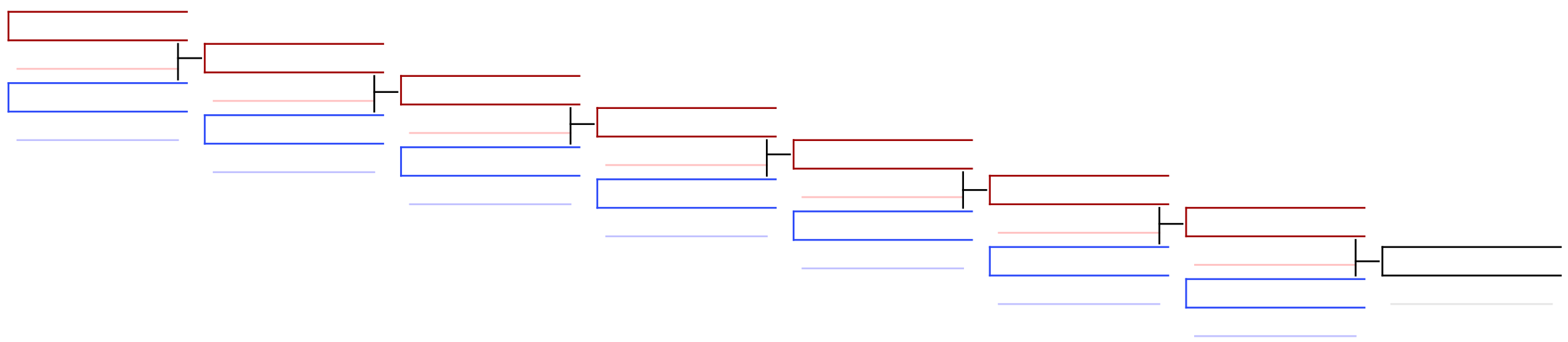

Referees:							
-----------	--	--	--	--	--	--	--

11 Yrs Kumite Male -40 kg

30th Balkan Karate Championships for Children 2026 - Istanbul

2026-05-30

Tatami
6 18:45

Pool
2

(c)sportdata GmbH & Co KG 2000-2026 (2026-05-31 14:44) v 12.2.0 build 1 (2026-05-24 19:07 CET) License: Lazar Piper SRB (expire 2027-01-23)

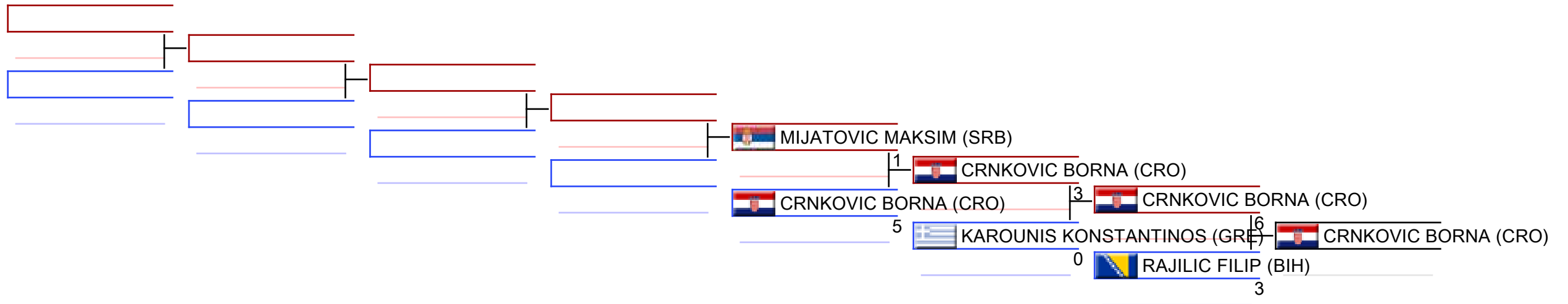

REPECHAGE: (2)

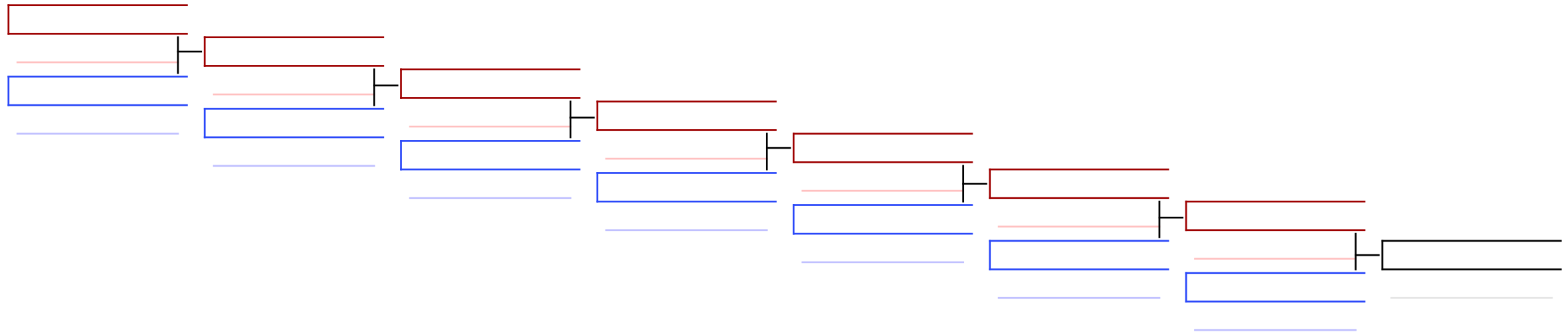

Referees:							
-----------	--	--	--	--	--	--	--

11 Yrs Kumite Male -45 kg

30th Balkan Karate Championships for Children 2026 - Istanbul, Basaksehir Spor Hall, Kayabaşı, TINAZTEPE CADDESİ NO:6, 34494 Başakşehir, İstanbul, TUR2026-05-31

Tatami
5 10:05

Pool
1/1

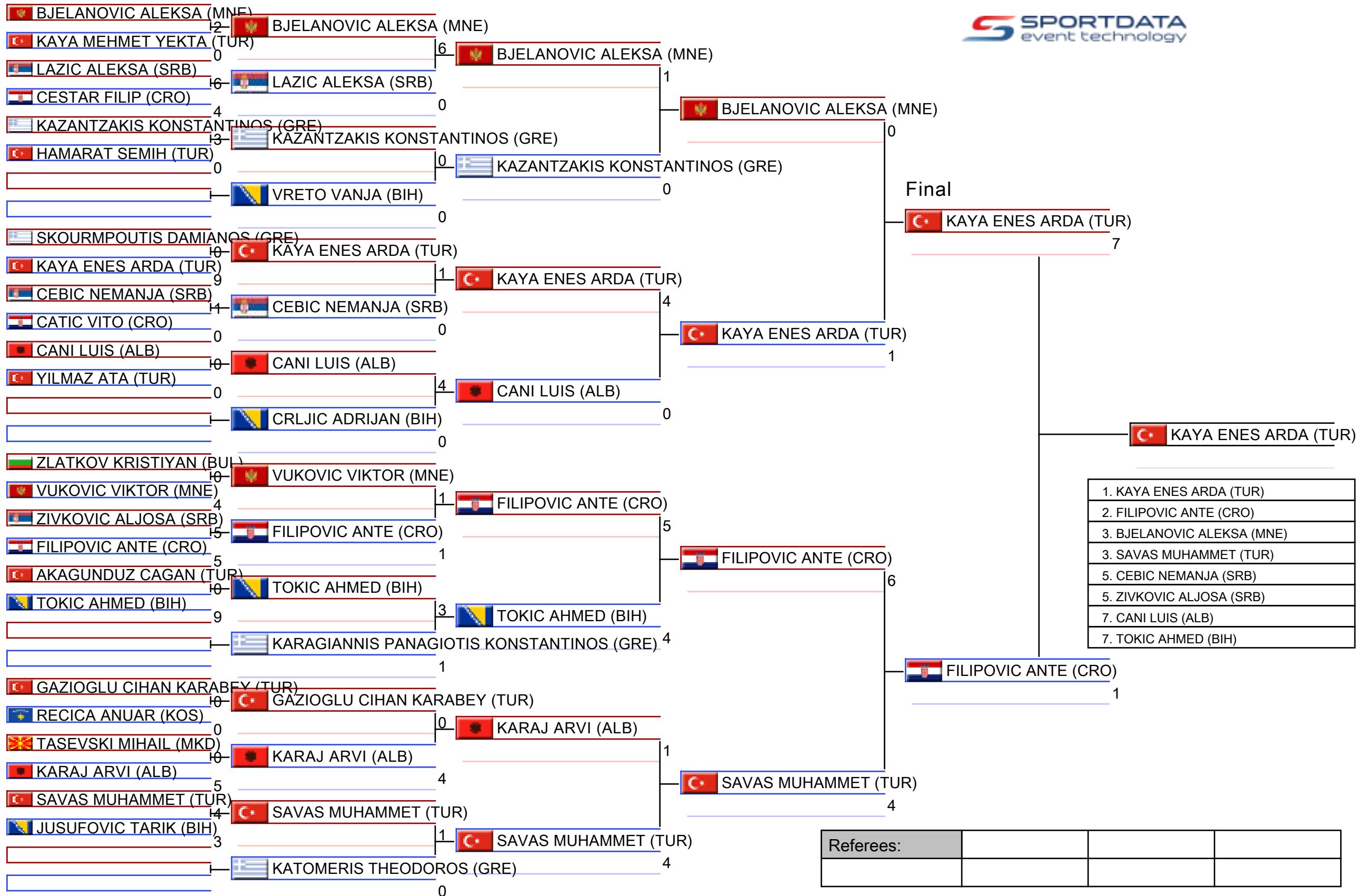

11 Yrs Kumite Male -45 kg

30th Balkan Karate Championships for Children 2026 - Istanbul

2026-05-31

Tatami
5 11:35

Pool
1

(c)sportdata GmbH & Co KG 2000-2026 (2026-05-31 14:44) v 12.2.0 build 1 (2026-05-24 19:07 CET) License: Lazar Piper SRB (expire 2027-01-23)

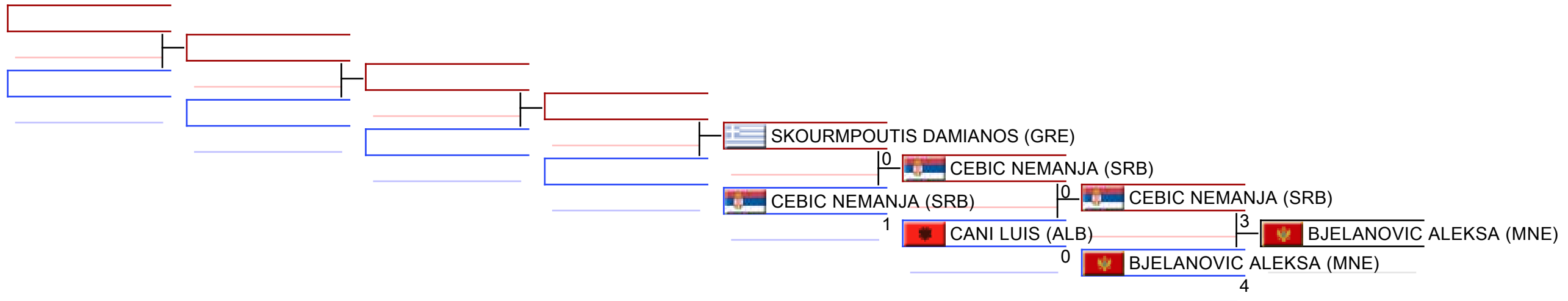

REPECHAGE: (1)

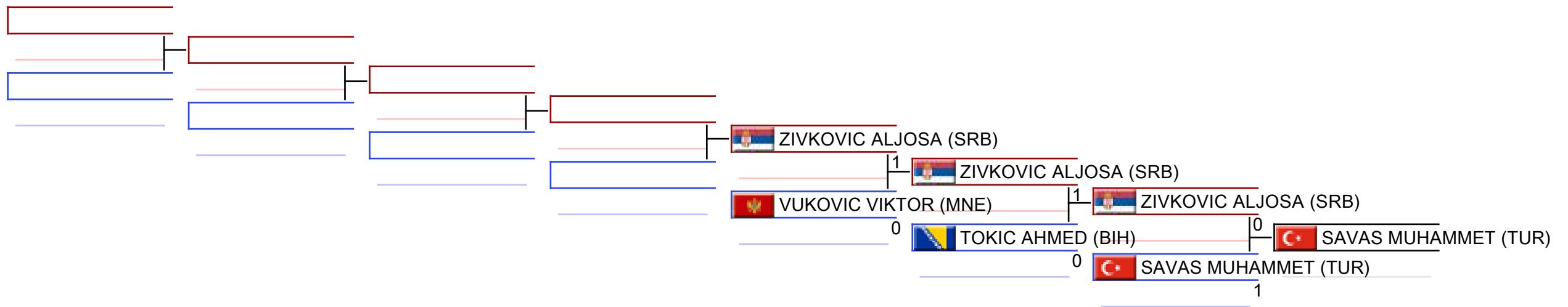

Referees:							
-----------	--	--	--	--	--	--	--

11 Yrs Kumite Male -50 kg

30th Balkan Karate Championships for Children 2026 - Istanbul, Basaksehir Spor Hall, Kayabaşı, TINAZTEPE CADDESİ NO:6, 34494 Başakşehir, İstanbul, TUR2026-05-30

Tatami

4 15:35

Pool

1/1

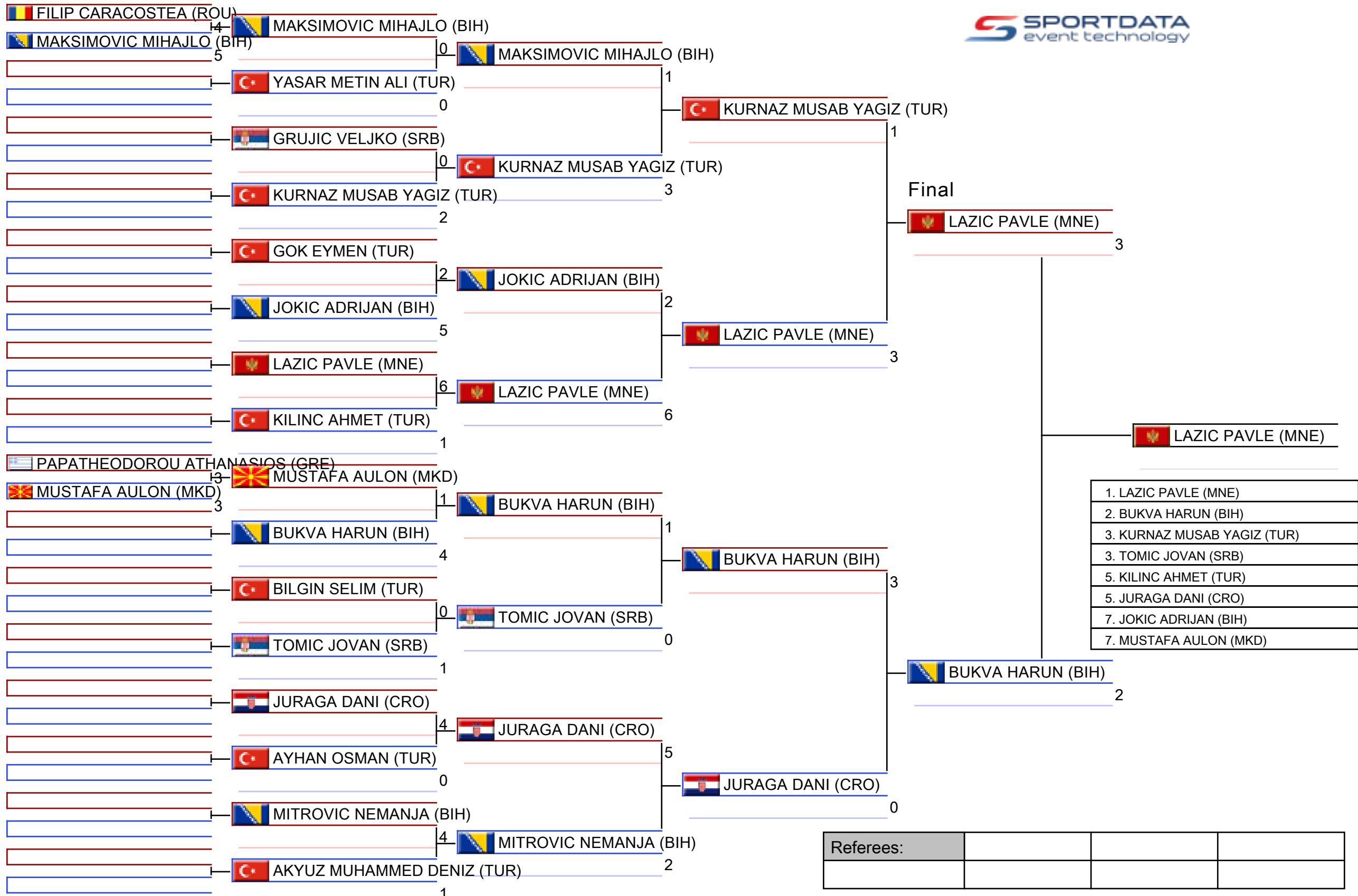

11 Yrs Kumite Male -50 kg

30th Balkan Karate Championships for Children 2026 - Istanbul

2026-05-30

Tatami
4 16:30

Pool
1

(c)sportdata GmbH & Co KG 2000-2026 (2026-05-31 14:44) v 12.2.0 build 1 (2026-05-24 19:07 CET) License: Lazar Piper SRB (expire 2027-01-23)

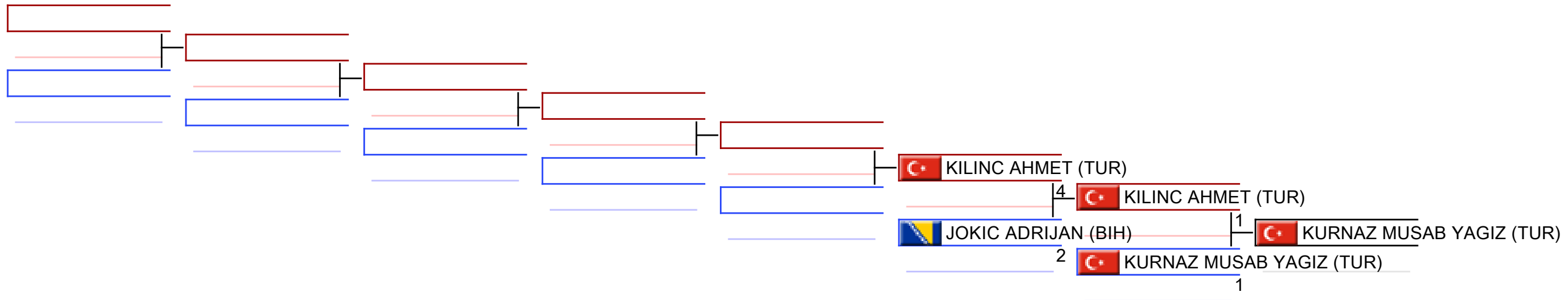

REPECHAGE: (1)

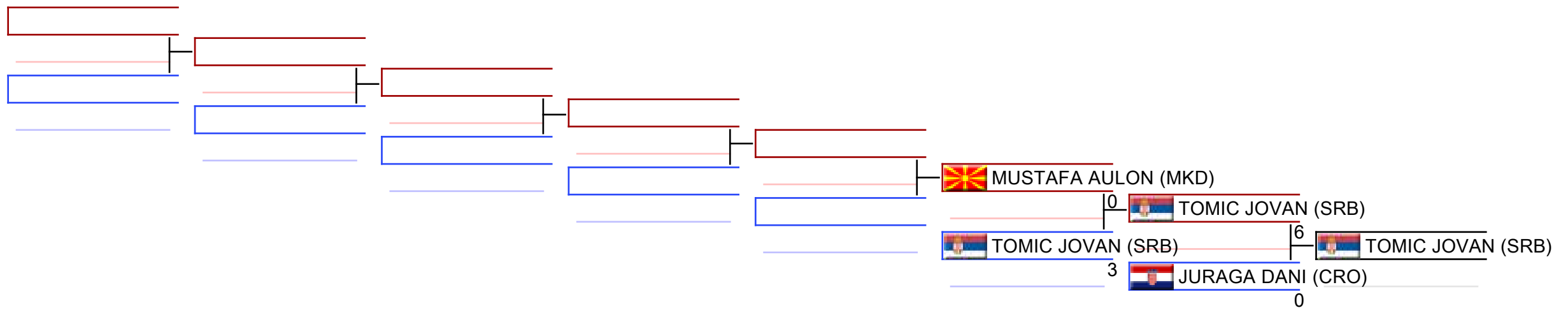

Referees:							
-----------	--	--	--	--	--	--	--

11 Yrs Kumite Male 50+ kg

30th Balkan Karate Championships for Children 2026 - Istanbul, Basaksehir Spor Hall, Kayabaşı, TINAZTEPE CADDESİ NO:6, 34494 Başakşehir, İstanbul, TUR2026-05-30

Tatami
1 13:35

Pool
1/1

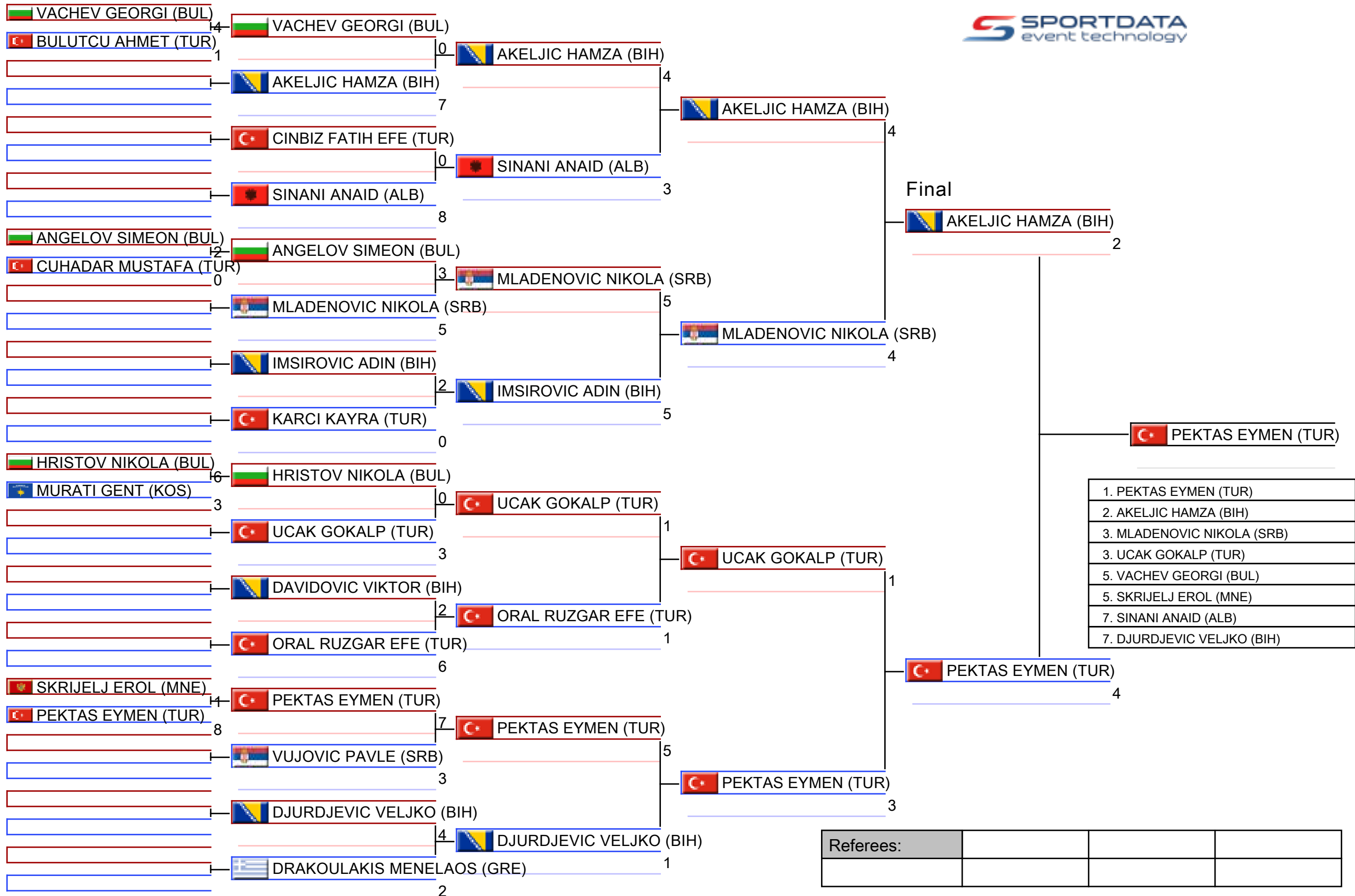

11 Yrs Kumite Male 50+ kg

30th Balkan Karate Championships for Children 2026 - Istanbul

2026-05-30

Tatami
1 14:40

Pool
1

(c)sportdata GmbH & Co KG 2000-2026 (2026-05-31 14:44) v 12.2.0 build 1 (2026-05-24 19:07 CET) License: Lazar Piper SRB (expire 2027-01-23)

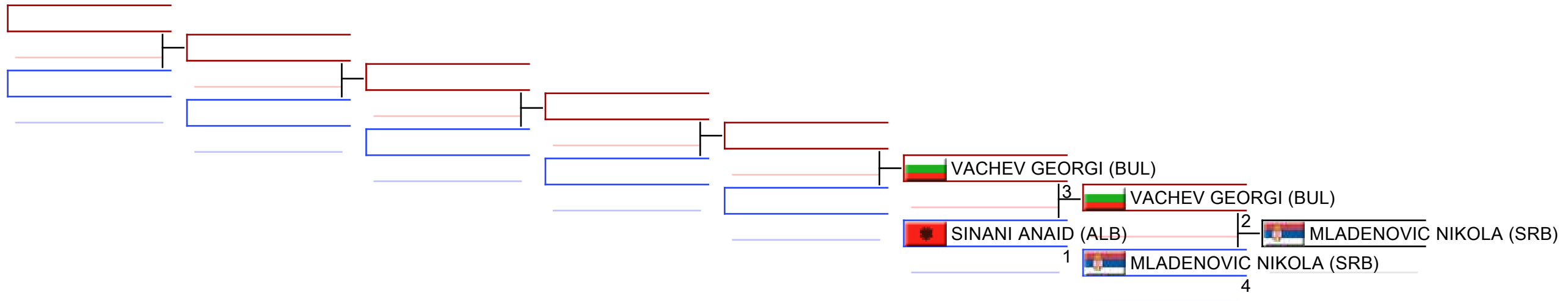

REPECHAGE: (1)

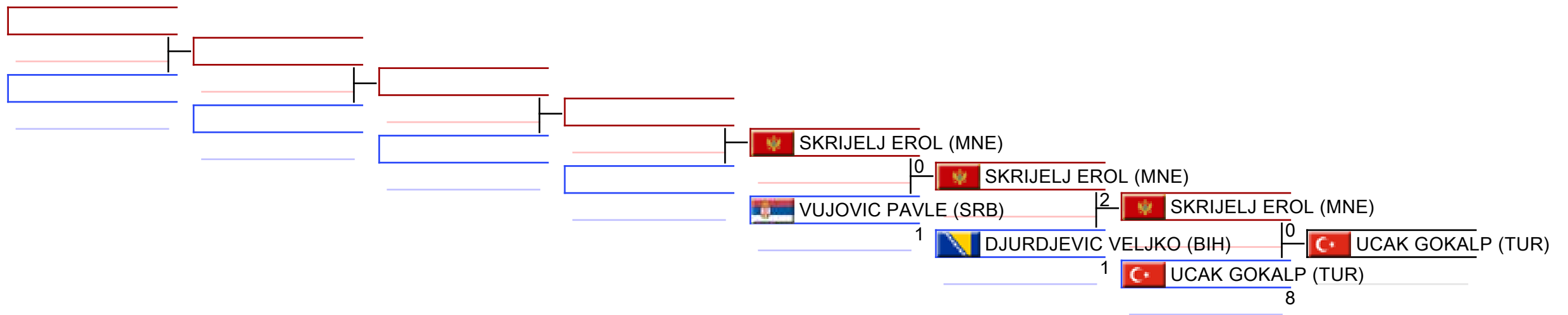

Referees:							
-----------	--	--	--	--	--	--	--

12-13 Yrs Kata Team Female

30th Balkan Karate Championships for Children 2026 - Istanbul, Basaksehir Spor Hall, Kayabaşı, TINAZTEPE CADDESİ NO:6, 34494 Başakşehir, İstanbul, TUR2026-05-31

Tatami

5 09:00

Pool

1/1

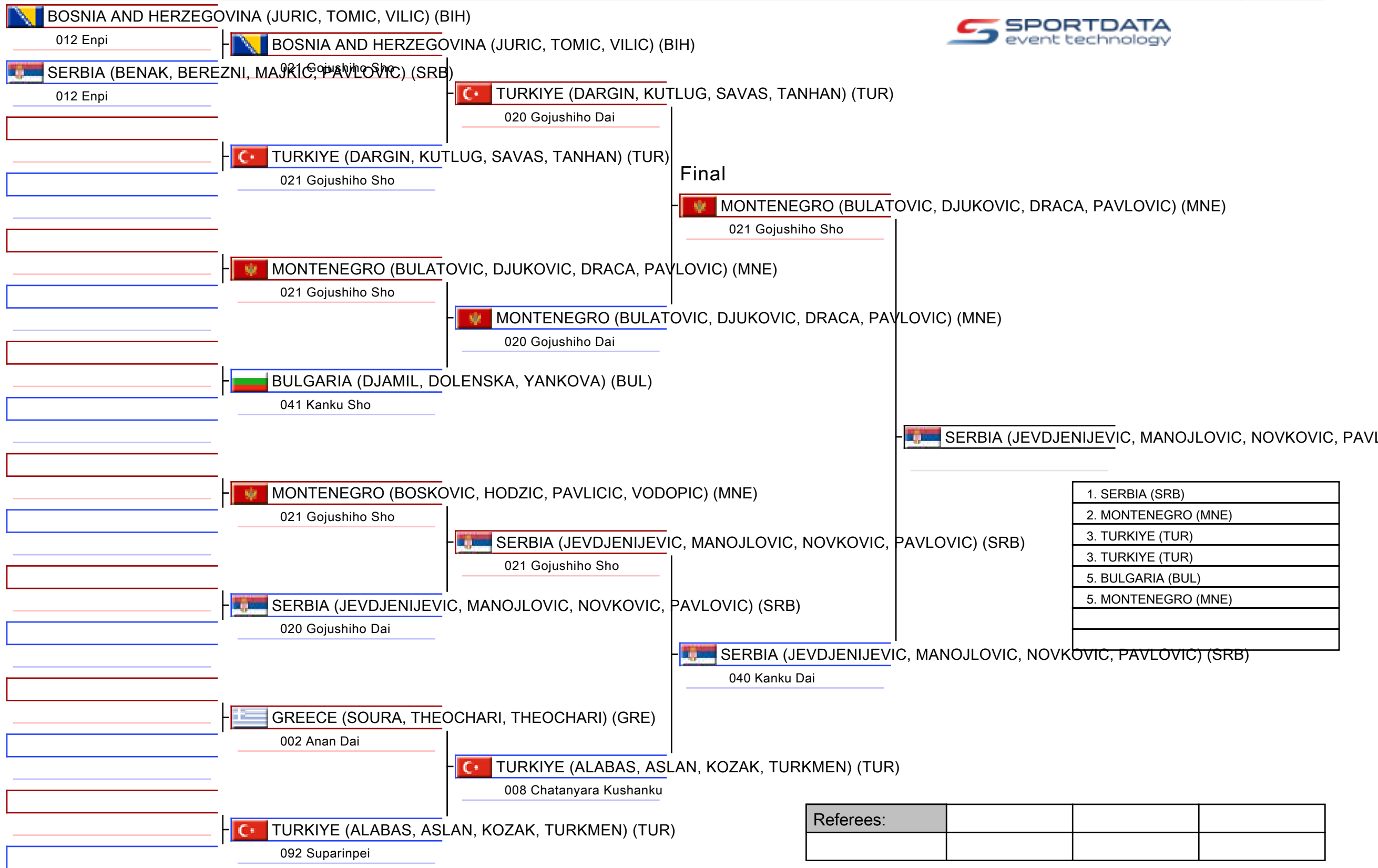

12-13 Yrs Kata Team Female

30th Balkan Karate Championships for Children 2026 - Istanbul

2026-05-31

Tatami
5 09:35

Pool
1

(c)sportdata GmbH & Co KG 2000-2026 (2026-05-31 14:44) v 12.2.0 build 1 (2026-05-24 19:07 CET) License: Lazar Piper SRB (expire 2027-01-23)

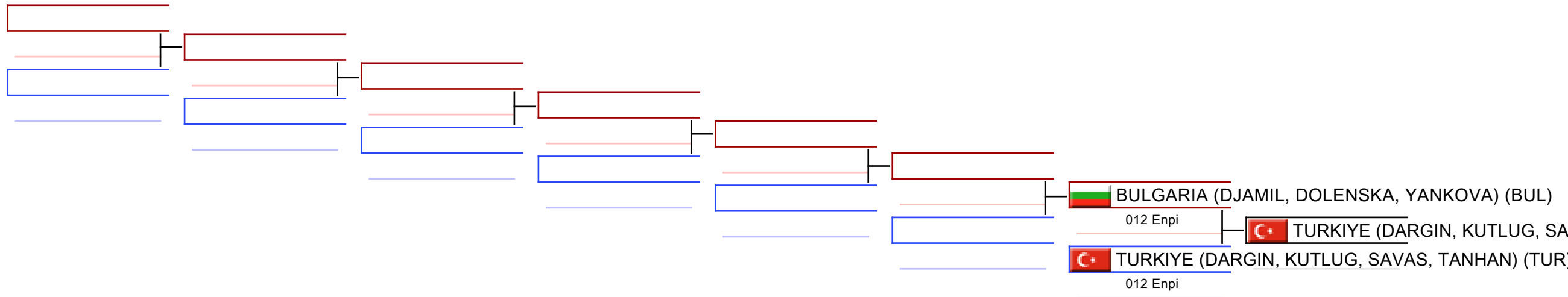

REPECHAGE: (1)

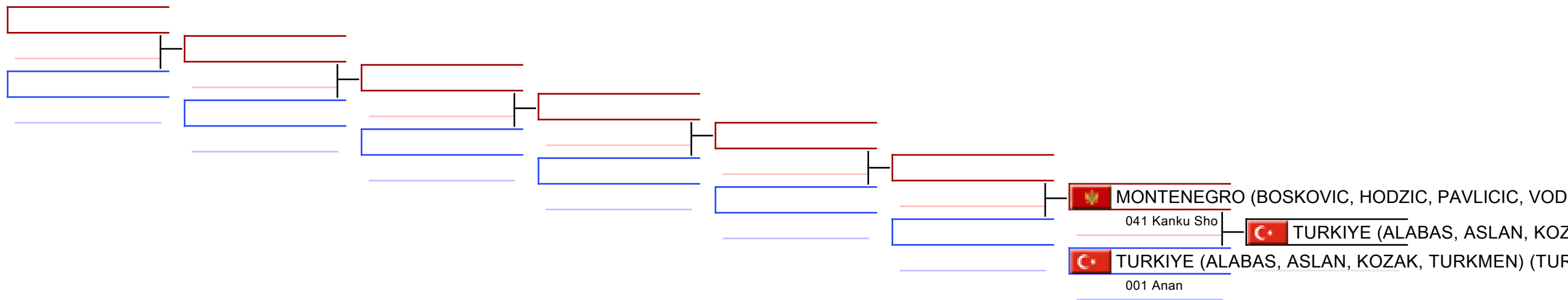

Referees:							
-----------	--	--	--	--	--	--	--

12-13 Yrs Kata Team Male

30th Balkan Karate Championships for Children 2026 - Istanbul, Basaksehir Spor Hall, Kayabaşı, TINAZTEPE CADDESİ NO:6, 34494 Başakşehir, İstanbul, TUR2026-05-31

Tatami

6 09:00

Pool

1/1

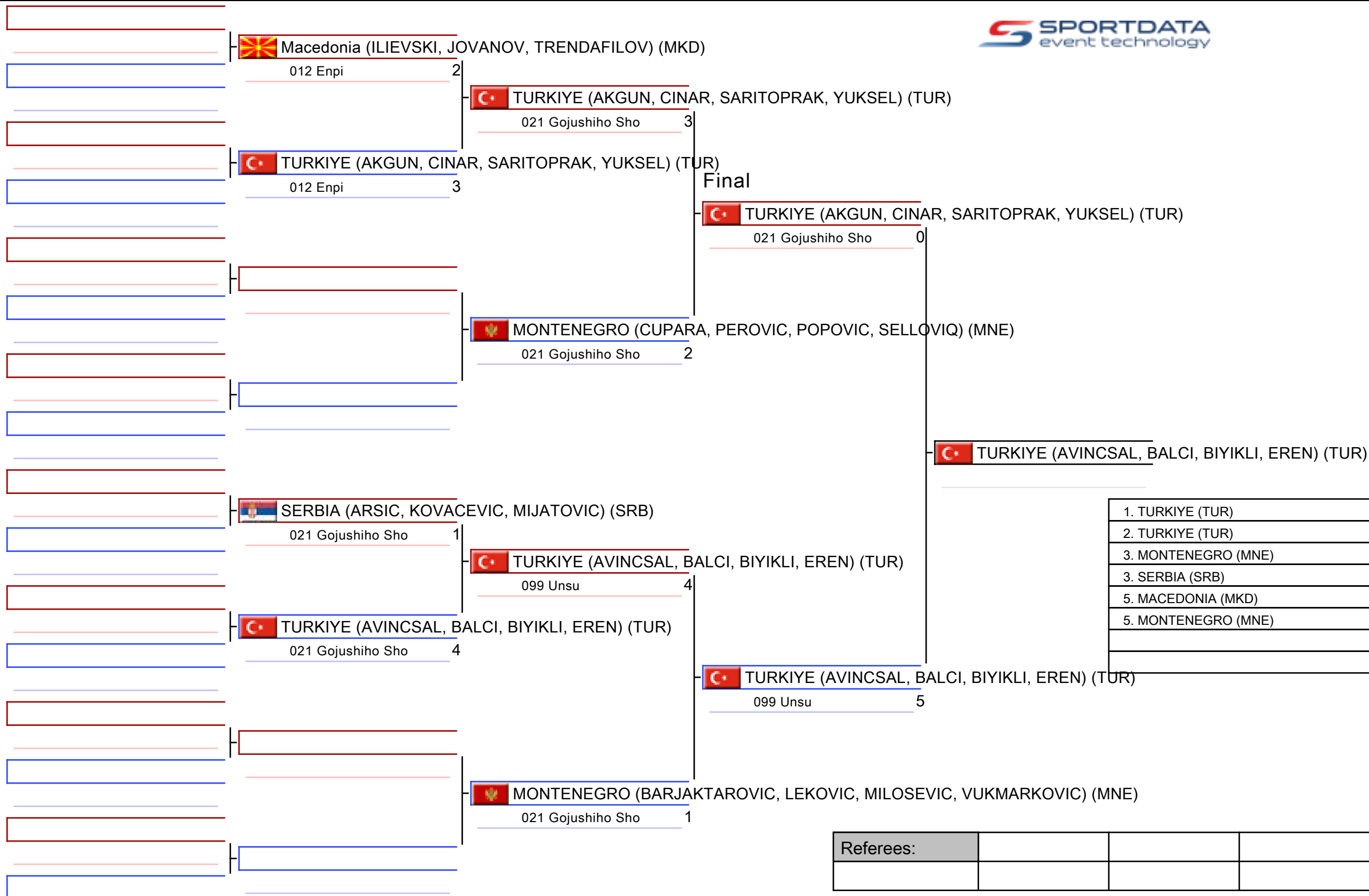

1. TURKIYE (TUR)
2. TURKIYE (TUR)
3. MONTENEGRO (MNE)
3. SERBIA (SRB)
5. MACEDONIA (MKD)
5. MONTENEGRO (MNE)

Referees:			

12-13 Yrs Kata Team Male

30th Balkan Karate Championships for Children 2026 - Istanbul

2026-05-31

Tatami
6 09:20

Pool
1

(c)sportdata GmbH & Co KG 2000-2026 (2026-05-31 14:44) v 12.2.0 build 1 (2026-05-24 19:07 CET) License: Lazar Piper SRB (expire 2027-01-23)

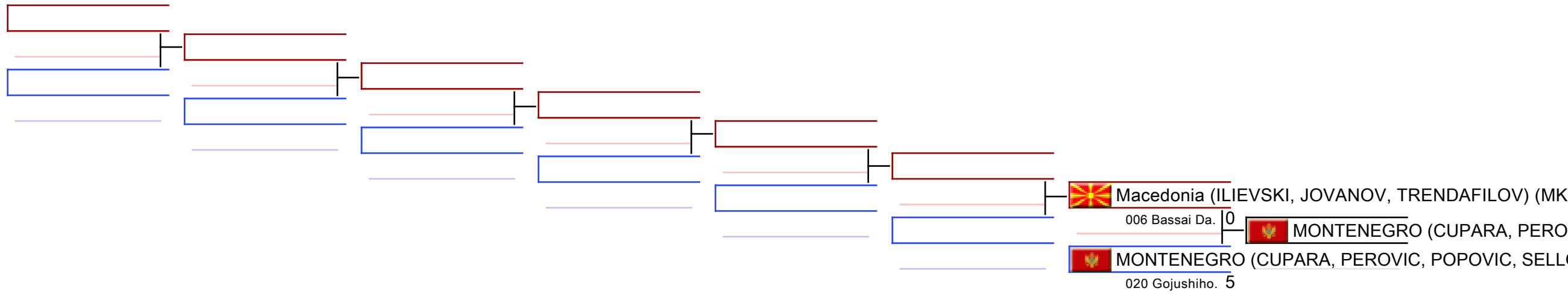

REPECHAGE: (1)

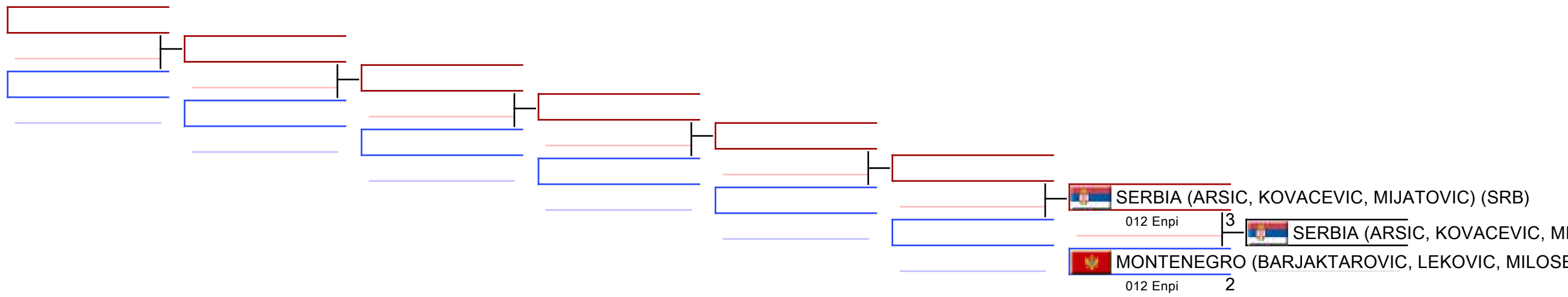

Referees:							
-----------	--	--	--	--	--	--	--

12 Yrs Kata Individual Female

30th Balkan Karate Championships for Children 2026 - Istanbul, Basaksehir Spor Hall, Kayabaşı, TINAZTEPE CADDESİ NO:6, 34494 Başakşehir, İstanbul, TUR2026-05-30

Tatami

1 10:50

Pool

1/2

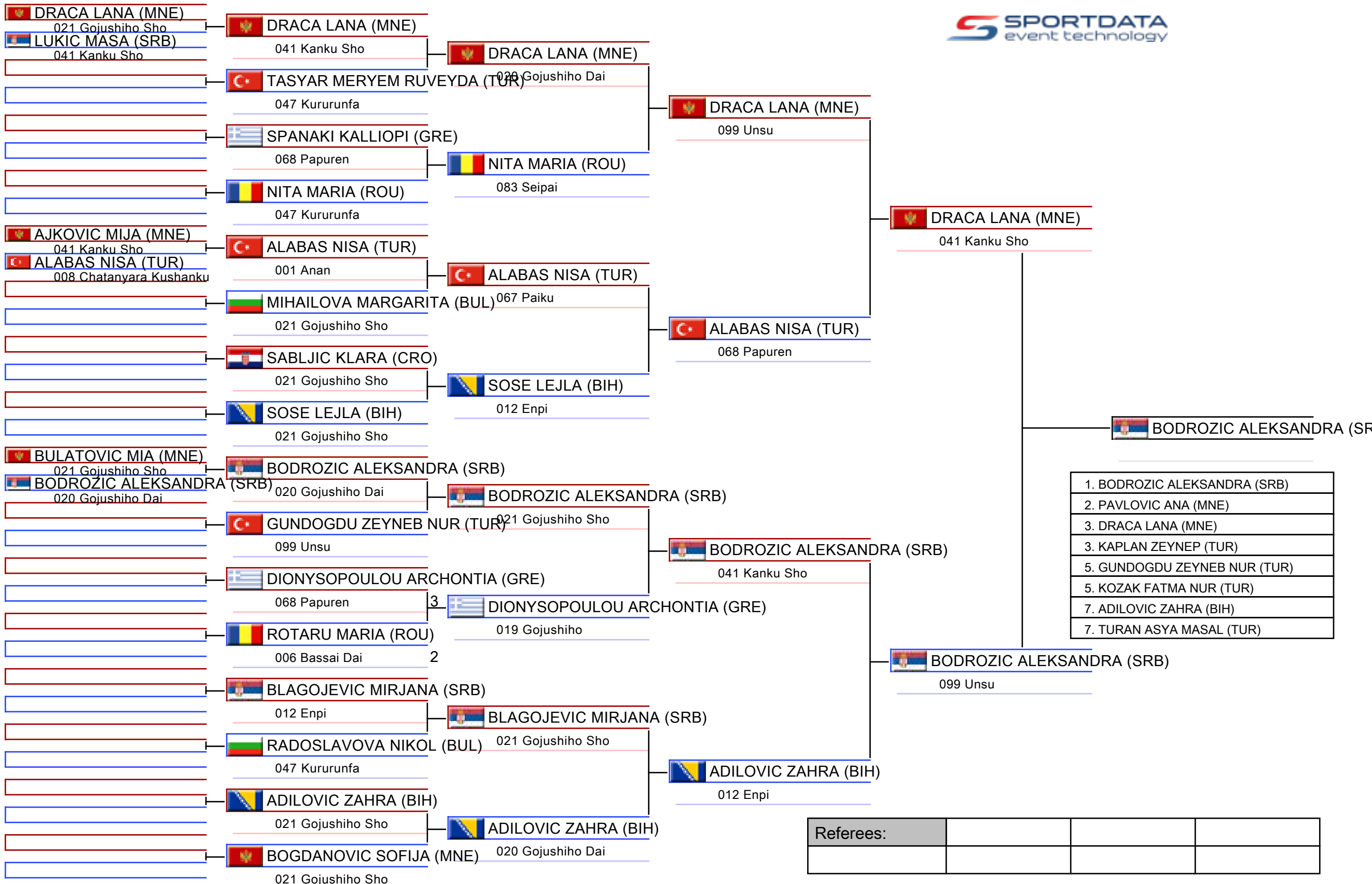

Referees:			

Pool winner-12 Yrs Kata Individual Female

30th Balkan Karate Championships for Children 2026 - Istanbul, Basaksehir Spor Hall, Kayabaşı, TINAZTEPE CADDESİ NO:6, 34494 Başakşehir, İstanbul, TUR

Tatami

Pool

1/1

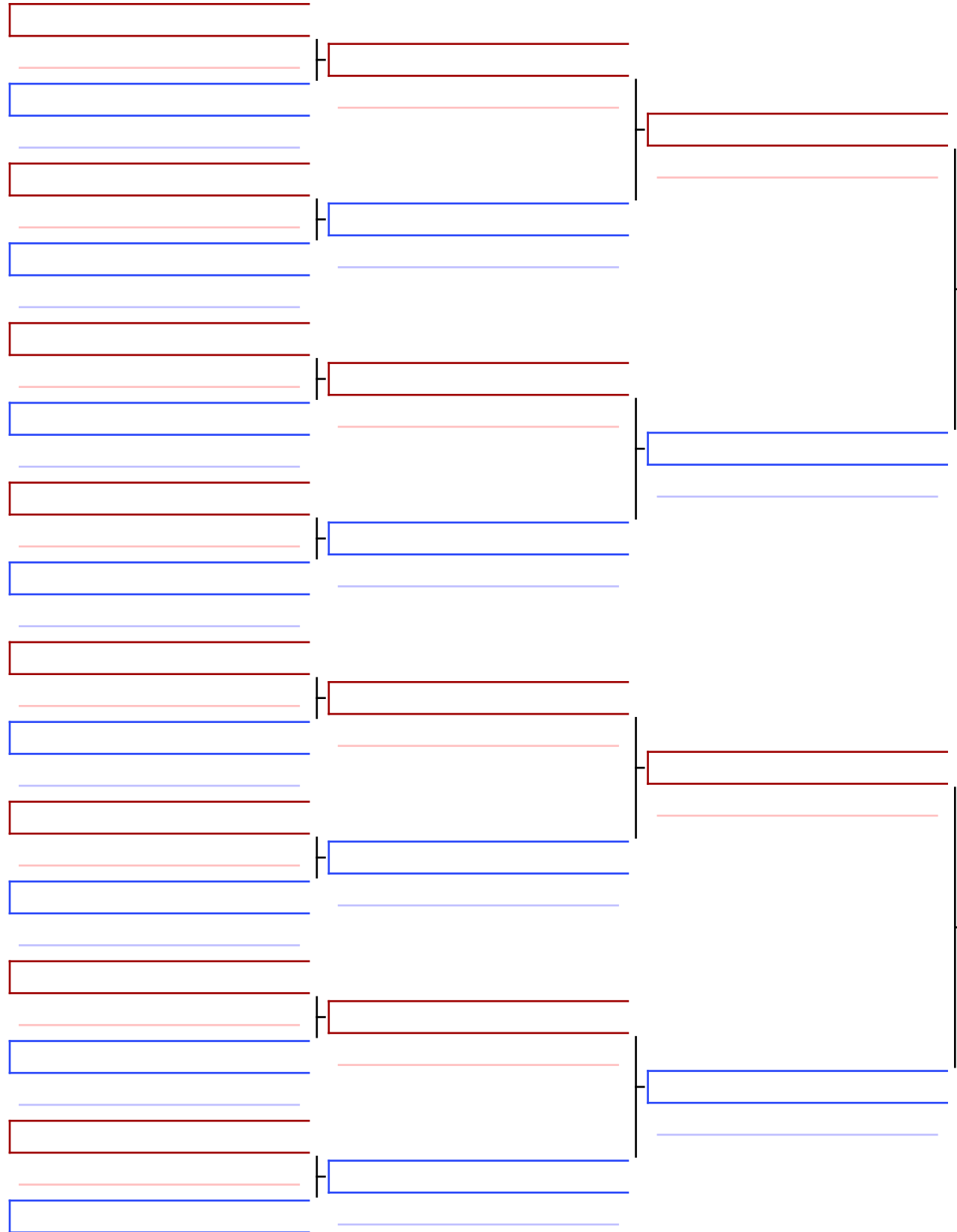

Final

 **BODROZIC ALEKSANDRA (SRB)**

041 Kanku Sho 3

 **BODROZIC ALEKSANDRA (SRB)**

 **PAVLOVIC ANA (MNE)**

021 Gojushiho Sho 2

- | |
|------------------------------|
| 1. BODROZIC ALEKSANDRA (SRB) |
| 2. PAVLOVIC ANA (MNE) |
| 3. DRACA LANA (MNE) |
| 3. KAPLAN ZEYNEP (TUR) |
| 5. GUNDOGDU ZEYNEB NUR (TUR) |
| 5. KOZAK FATMA NUR (TUR) |
| 7. ADILOVIC ZAHRA (BIH) |
| 7. TURAN ASYA MASAL (TUR) |

Referees:

12 Yrs Kata Individual Female

30th Balkan Karate Championships for Children 2026 - Istanbul

2026-05-30

Tatami
2 12:20

Pool
1,2

(c)sportdata GmbH & Co KG 2000-2026 (2026-05-31 14:44) v 12.2.0 build 1 (2026-05-24 19:07 CET) License: Lazar Piper SRB (expire 2027-01-23)

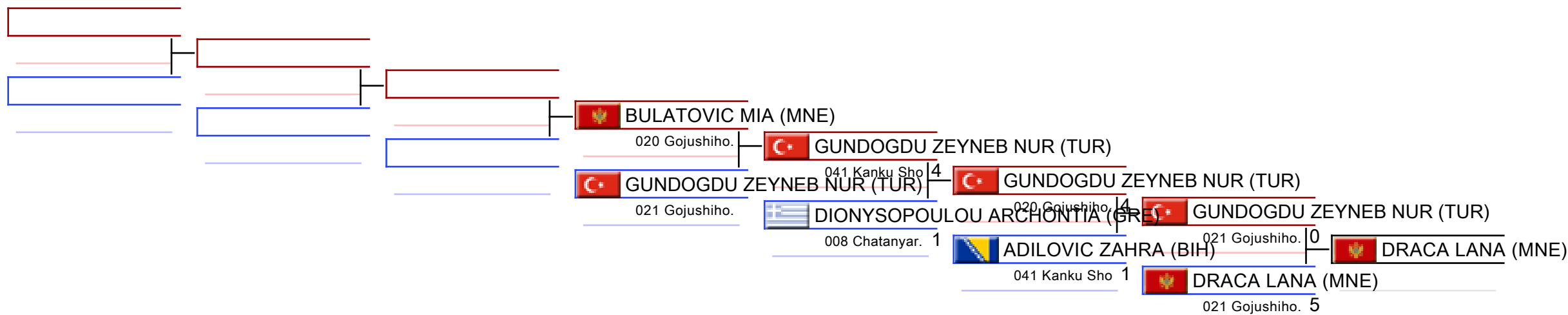

REPECHAGE: (1,2)

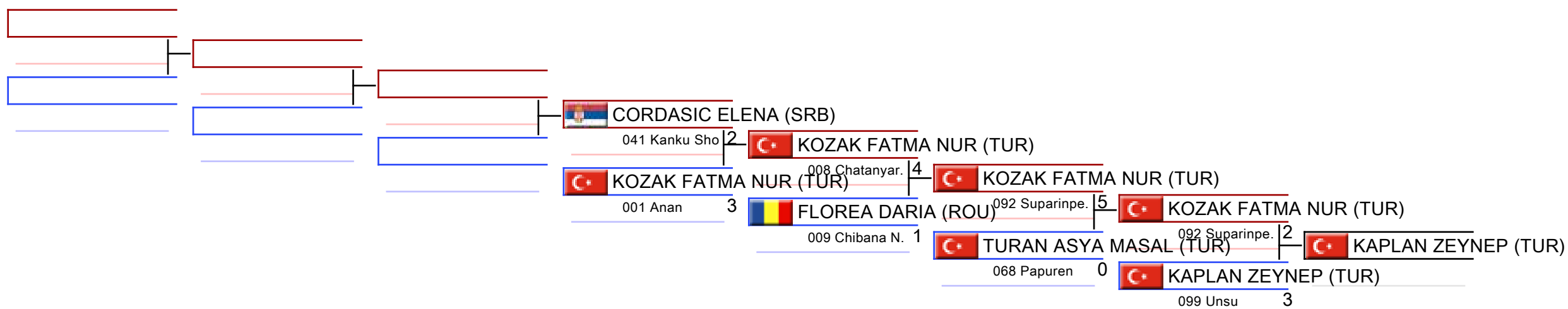

Referees:							
-----------	--	--	--	--	--	--	--

12 Yrs Kata Individual Male

30th Balkan Karate Championships for Children 2026 - Istanbul, Basaksehir Spor Hall, Kayabaşı, TINAZTEPE CADDESİ NO:6, 34494 Başakşehir, İstanbul, TUR2026-05-29

Tatami

2 09:00

Pool

1/2

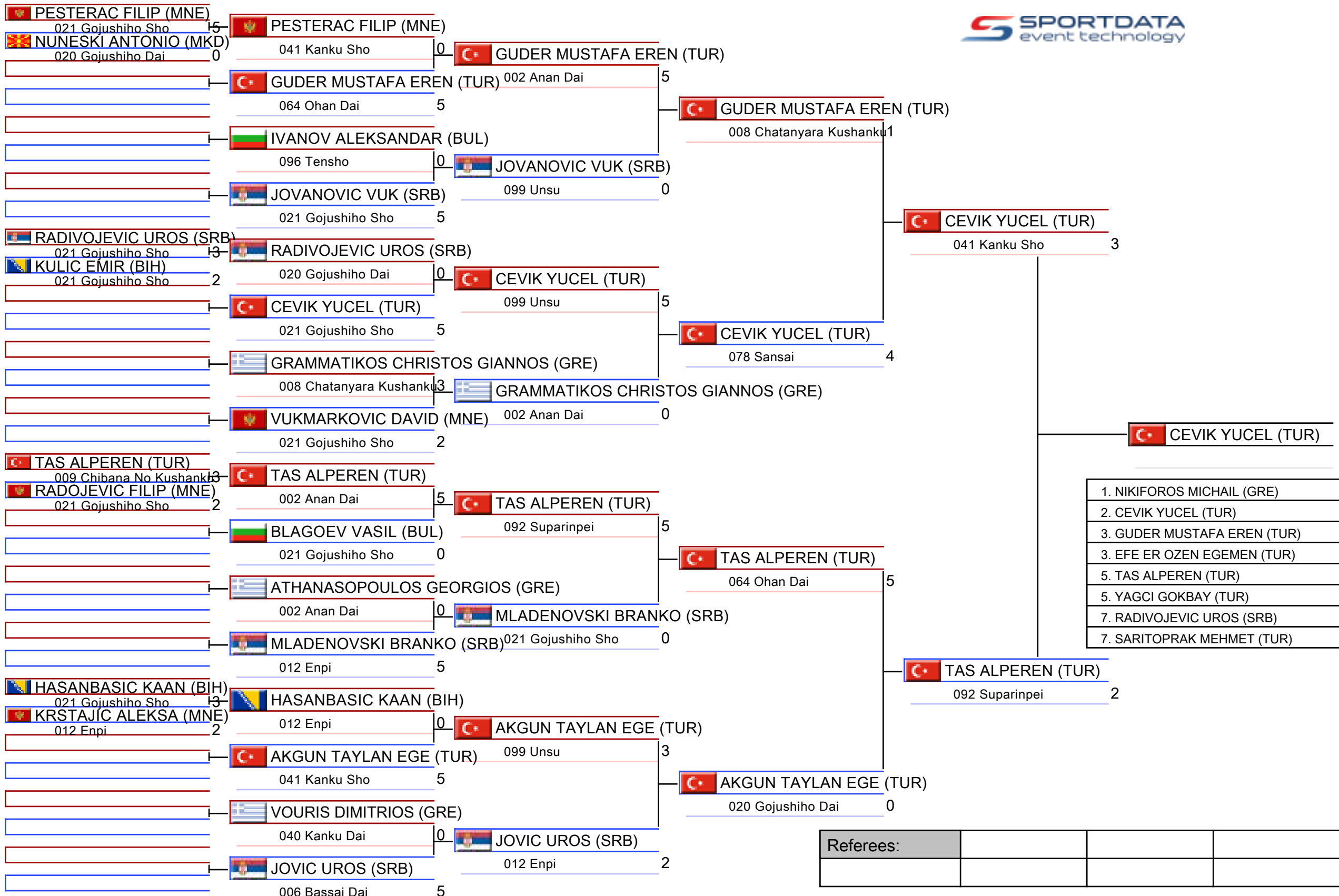

- | |
|-----------------------------|
| 1. NIKIFOROS MICHAEL (GRE) |
| 2. CEVIK YUCEL (TUR) |
| 3. GUDER MUSTAFA EREN (TUR) |
| 3. EFE ER OZEN EGEMEN (TUR) |
| 5. TAS ALPEREN (TUR) |
| 5. YAGCI GOKBAY (TUR) |
| 7. RADIVOJEVIC UROS (SRB) |
| 7. SARITOPRAK MEHMET (TUR) |

Pool winner-12 Yrs Kata Individual Male

30th Balkan Karate Championships for Children 2026 - Istanbul, Basaksehir Spor Hall, Kayabaşı, TINAZTEPE CADDESİ NO:6, 34494 Başakşehir, İstanbul, TUR

Tatami

Pool

1/1

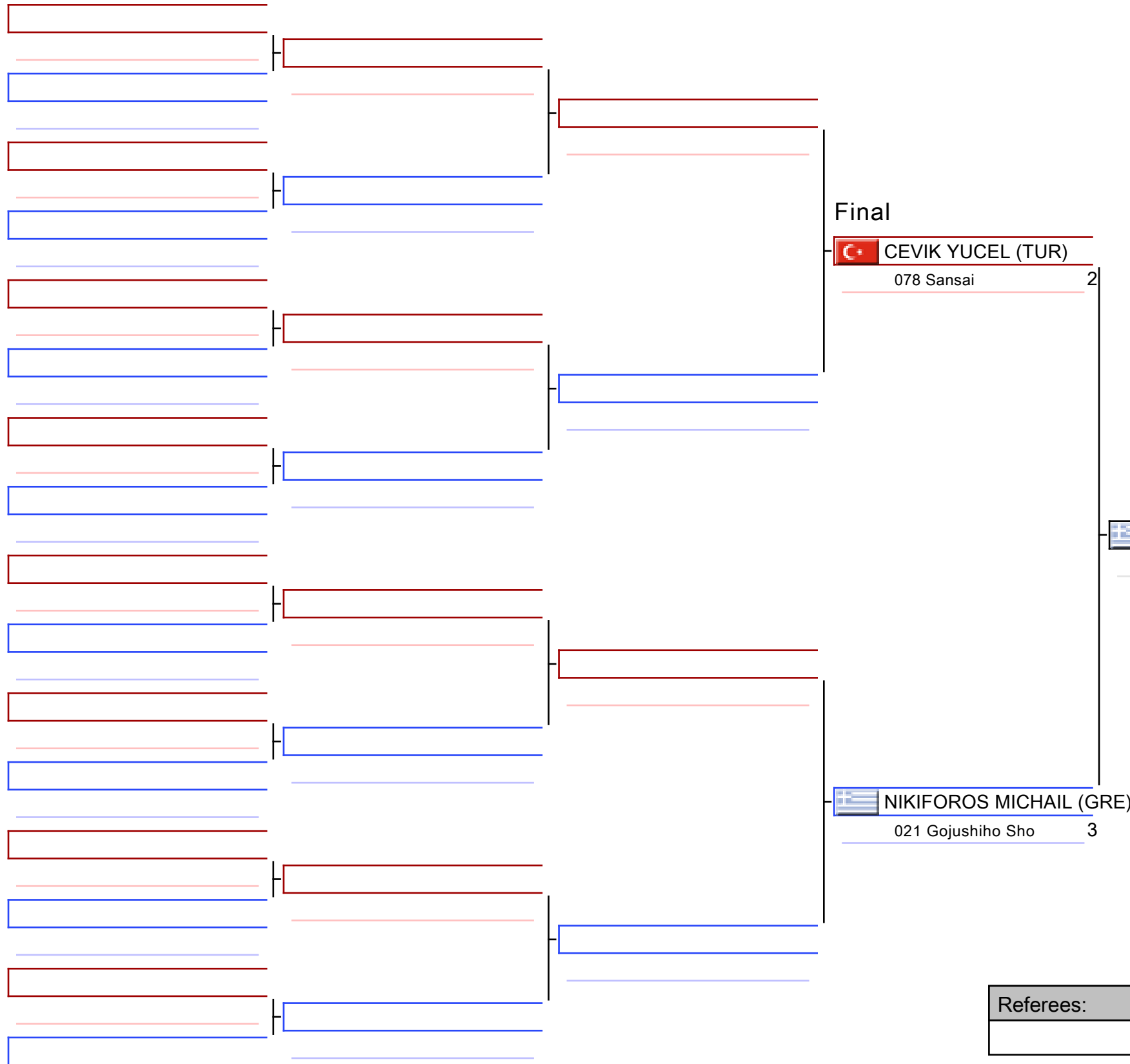

NIKIFOROS MICHAIL (GRE)

1. NIKIFOROS MICHAIL (GRE)
2. CEVIK YUCEL (TUR)
3. GUDER MUSTAFA EREN (TUR)
3. EFE ER OZEN EGEMEN (TUR)
5. TAS ALPEREN (TUR)
5. YAGCI GOKBAY (TUR)
7. RADIVOJEVIC UROS (SRB)
7. SARITOPRAK MEHMET (TUR)

Referees:			

12 Yrs Kata Individual Male

30th Balkan Karate Championships for Children 2026 - Istanbul

2026-05-29

Tatami
2 12:05

Pool
1,2

(c)sportdata GmbH & Co KG 2000-2026 (2026-05-31 14:44) v 12.2.0 build 1 (2026-05-24 19:07 CET) License: Lazar Piper SRB (expire 2027-01-23)

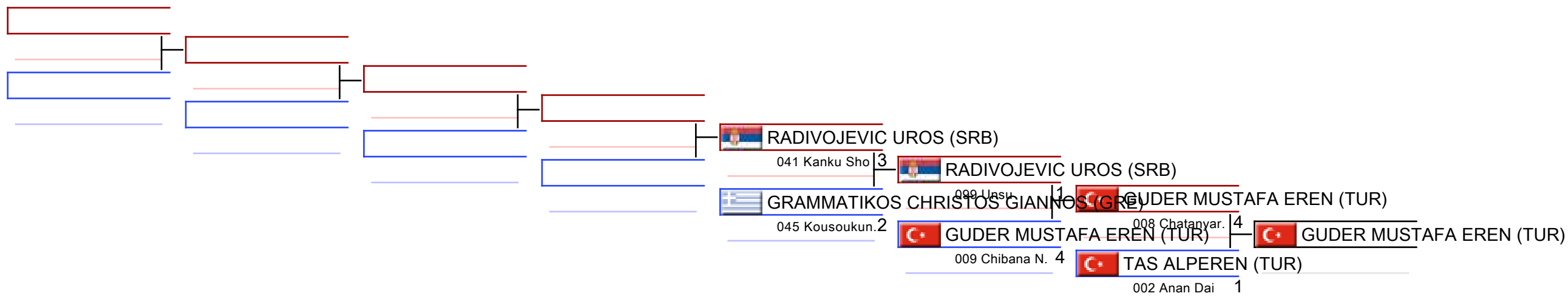

REPECHAGE: (1,2)

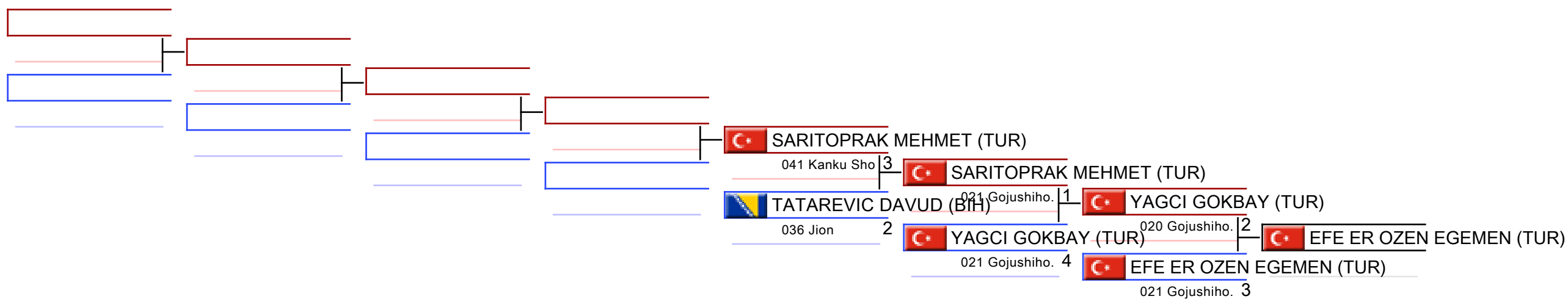

Referees:							
-----------	--	--	--	--	--	--	--

12 Yrs Kumite Female -35 kg

30th Balkan Karate Championships for Children 2026 - Istanbul, Basaksehir Spor Hall, Kayabaşı, TINAZTEPE CADDESİ NO:6, 34494 Başakşehir, İstanbul, TUR2026-05-29

Tatami

5 12:40

Pool

1/1

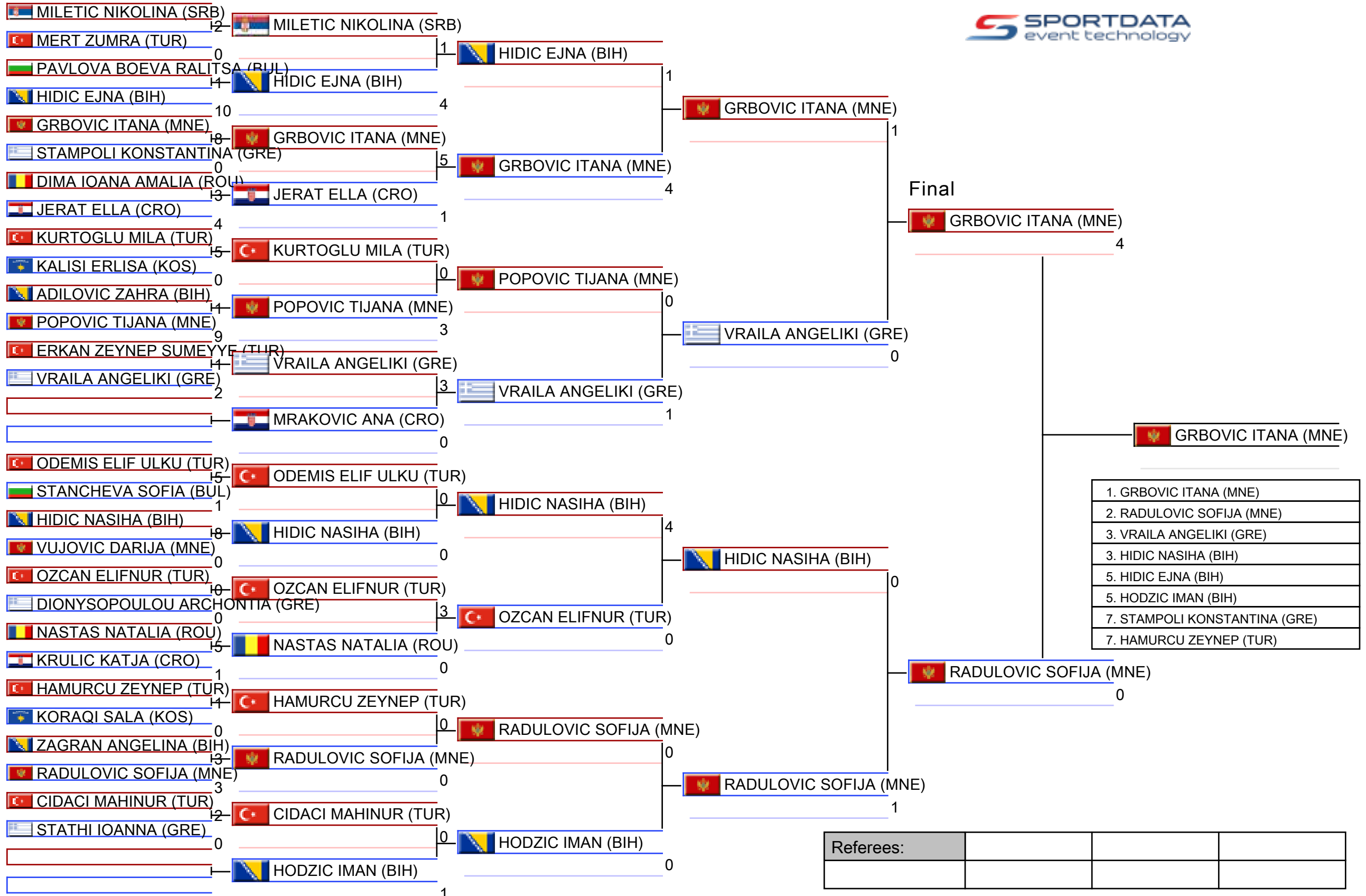

Referees:			

12 Yrs Kumite Female -35 kg

30th Balkan Karate Championships for Children 2026 - Istanbul

2026-05-29

Tatami
5 14:20

Pool
1

(c)sportdata GmbH & Co KG 2000-2026 (2026-05-31 14:44) v 12.2.0 build 1 (2026-05-24 19:07 CET) License: Lazar Piper SRB (expire 2027-01-23)

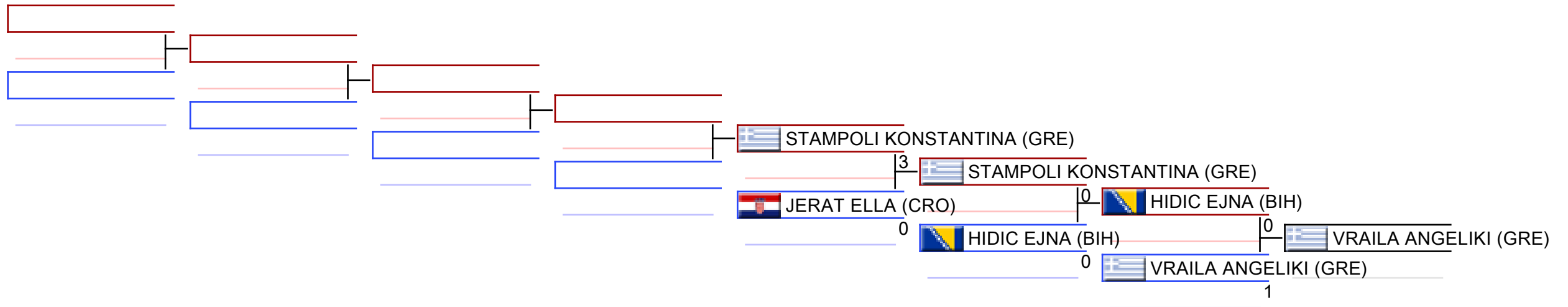

REPECHAGE: (1)

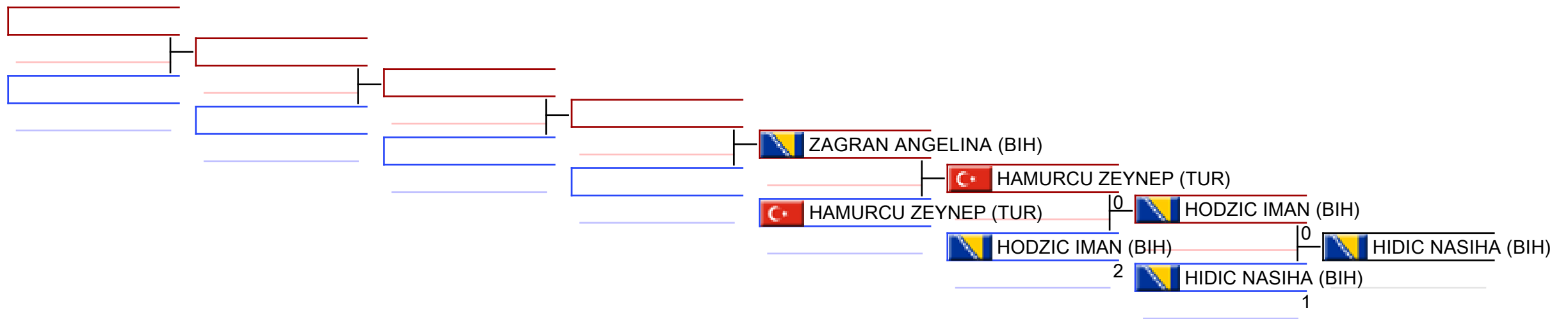

Referees:							
-----------	--	--	--	--	--	--	--

12 Yrs Kumite Female -40 kg

30th Balkan Karate Championships for Children 2026 - Istanbul, Basaksehir Spor Hall, Kayabaşı, TINAZTEPE CADDESİ NO:6, 34494 Başakşehir, İstanbul, TUR2026-05-31

Tatami

4 11:25

Pool

1/2

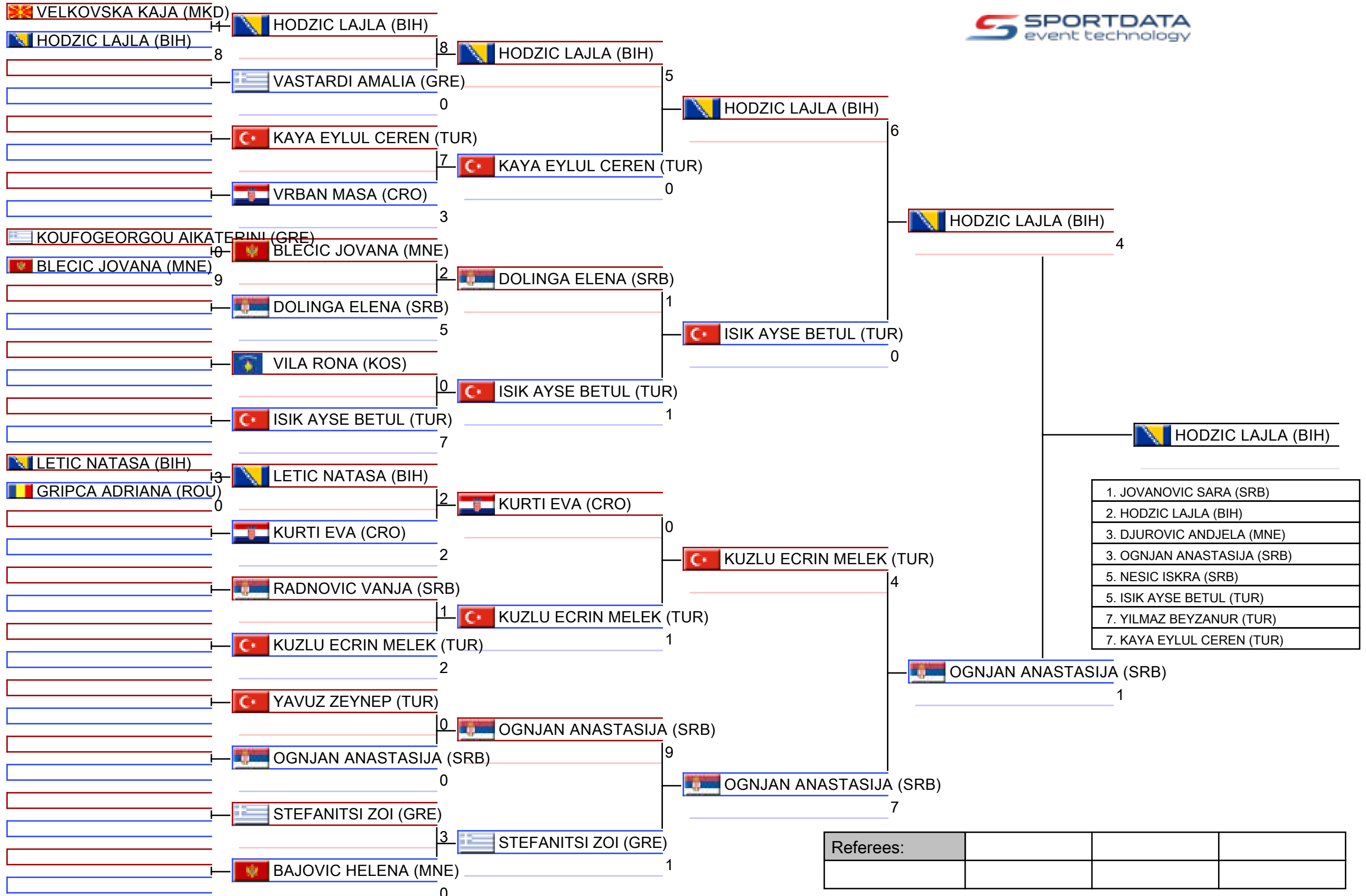

Referees:			

12 Yrs Kumite Female -40 kg

30th Balkan Karate Championships for Children 2026 - Istanbul, Basaksehir Spor Hall, Kayabaşı, TINAZTEPE CADDESİ NO:6, 34494 Başakşehir, İstanbul, TUR2026-05-31

Tatami

4 12:55

Pool

2/2

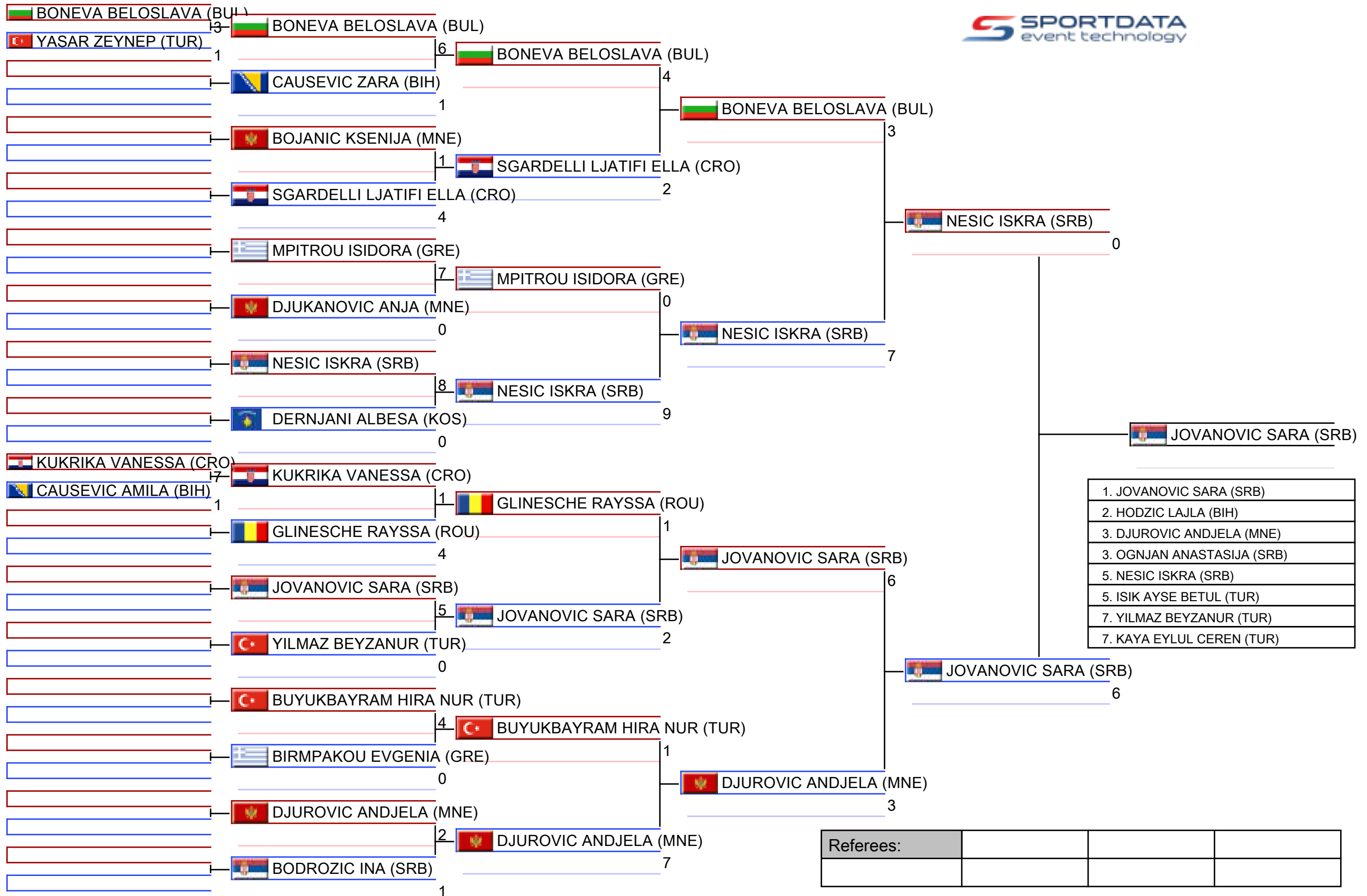

Pool winner-12 Yrs Kumite Female -40 kg

30th Balkan Karate Championships for Children 2026 - Istanbul, Basaksehir Spor Hall, Kayabaşı, TINAZTEPE CADDESİ NO:6, 34494 Başakşehir, İstanbul, TUR

Tatami

Pool

1/1

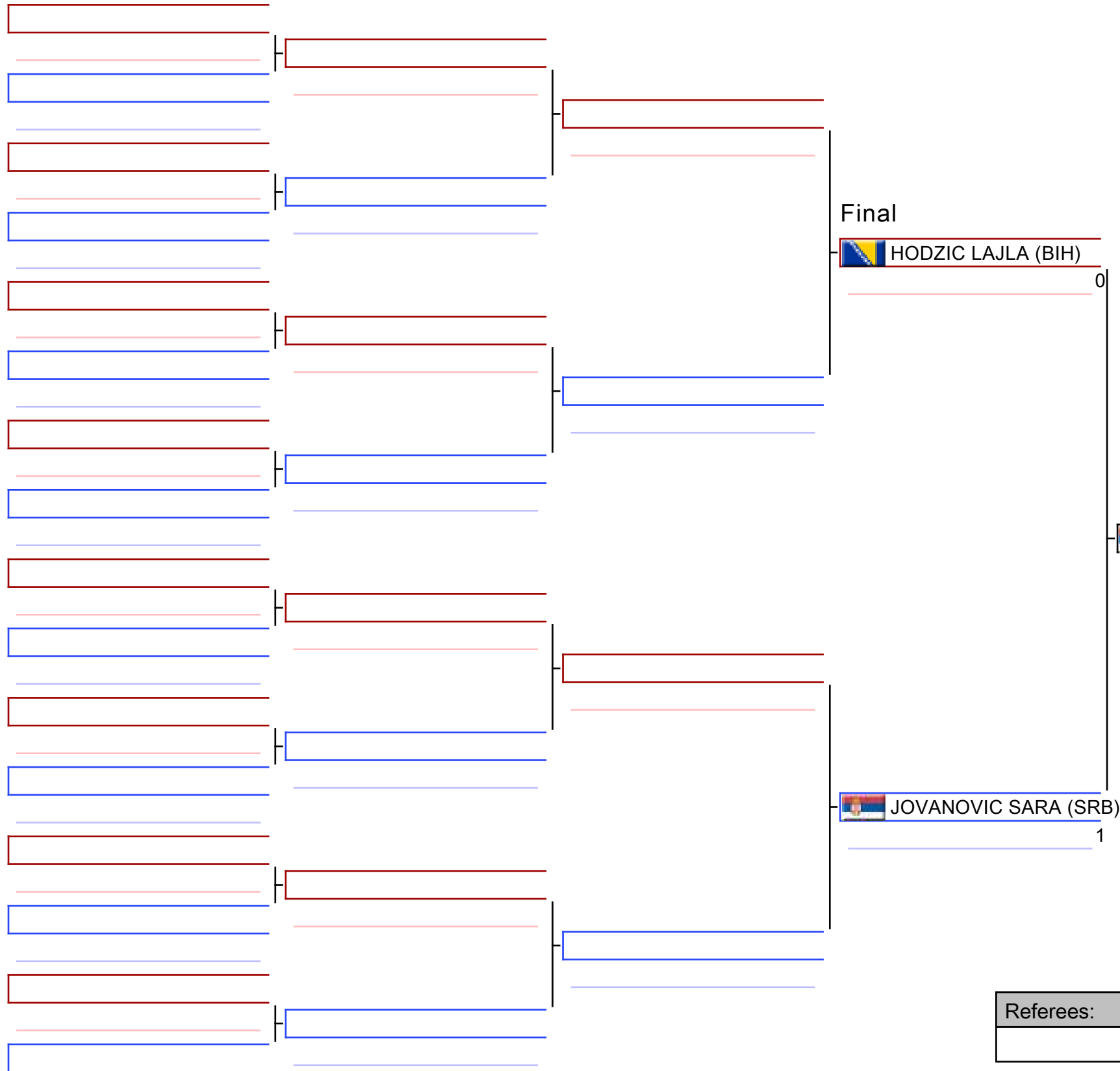

JOVANOVIC SARA (SRB)

1. JOVANOVIC SARA (SRB)
2. HODZIC LAJLA (BIH)
3. DJUROVIC ANDJELA (MNE)
3. OGNJAN ANASTASIJA (SRB)
5. NESIC ISKRA (SRB)
5. ISIK AYSE BETUL (TUR)
7. YILMAZ BEYZANUR (TUR)
7. KAYA EYLUL CEREN (TUR)

Referees:			

12 Yrs Kumite Female -40 kg

30th Balkan Karate Championships for Children 2026 - Istanbul

2026-05-31

Tatami
4 13:55

Pool
2,1

(c)sportdata GmbH & Co KG 2000-2026 (2026-05-31 14:44) v 12.2.0 build 1 (2026-05-24 19:07 CET) License: Lazar Piper SRB (expire 2027-01-23)

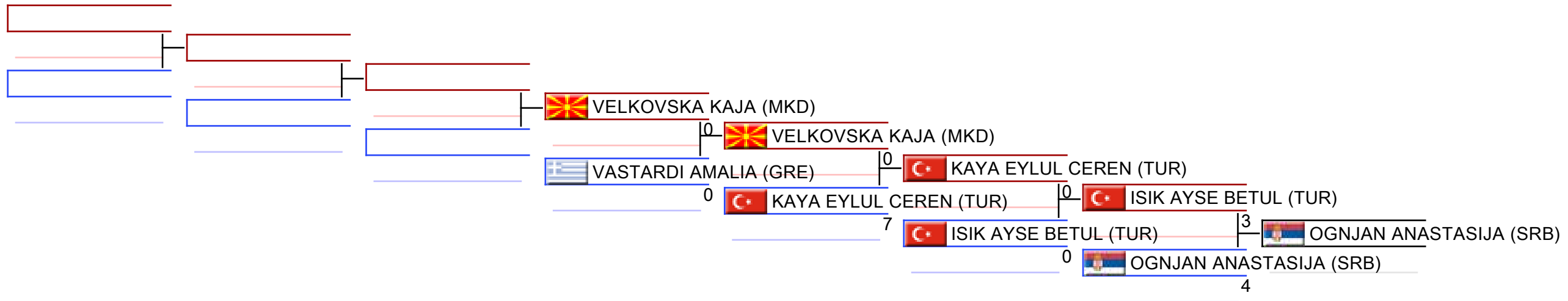

REPECHAGE: (2,1)

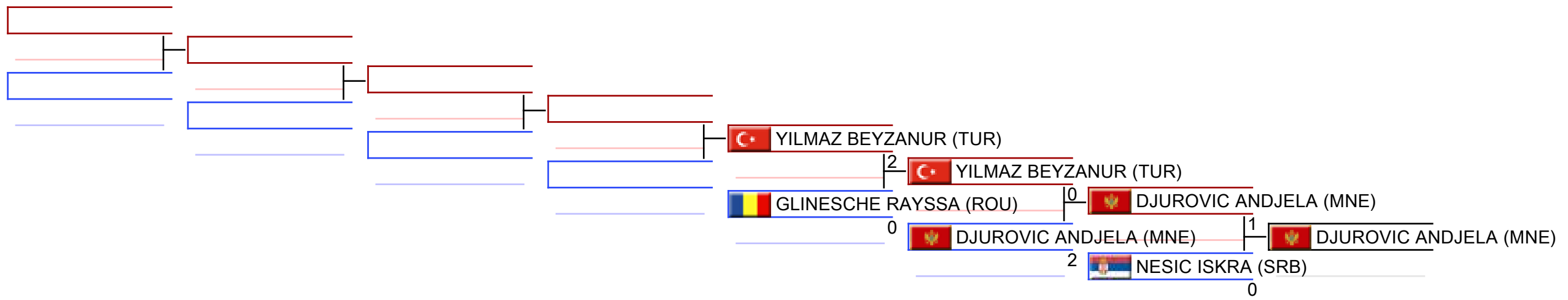

Referees:							
-----------	--	--	--	--	--	--	--

12 Yrs Kumite Female -45 kg

30th Balkan Karate Championships for Children 2026 - Istanbul, Basaksehir Spor Hall, Kayabaşı, TINAZTEPE CADDESİ NO:6, 34494 Başakşehir, İstanbul, TUR2026-05-29

Tatami

6 11:40

Pool

1/2

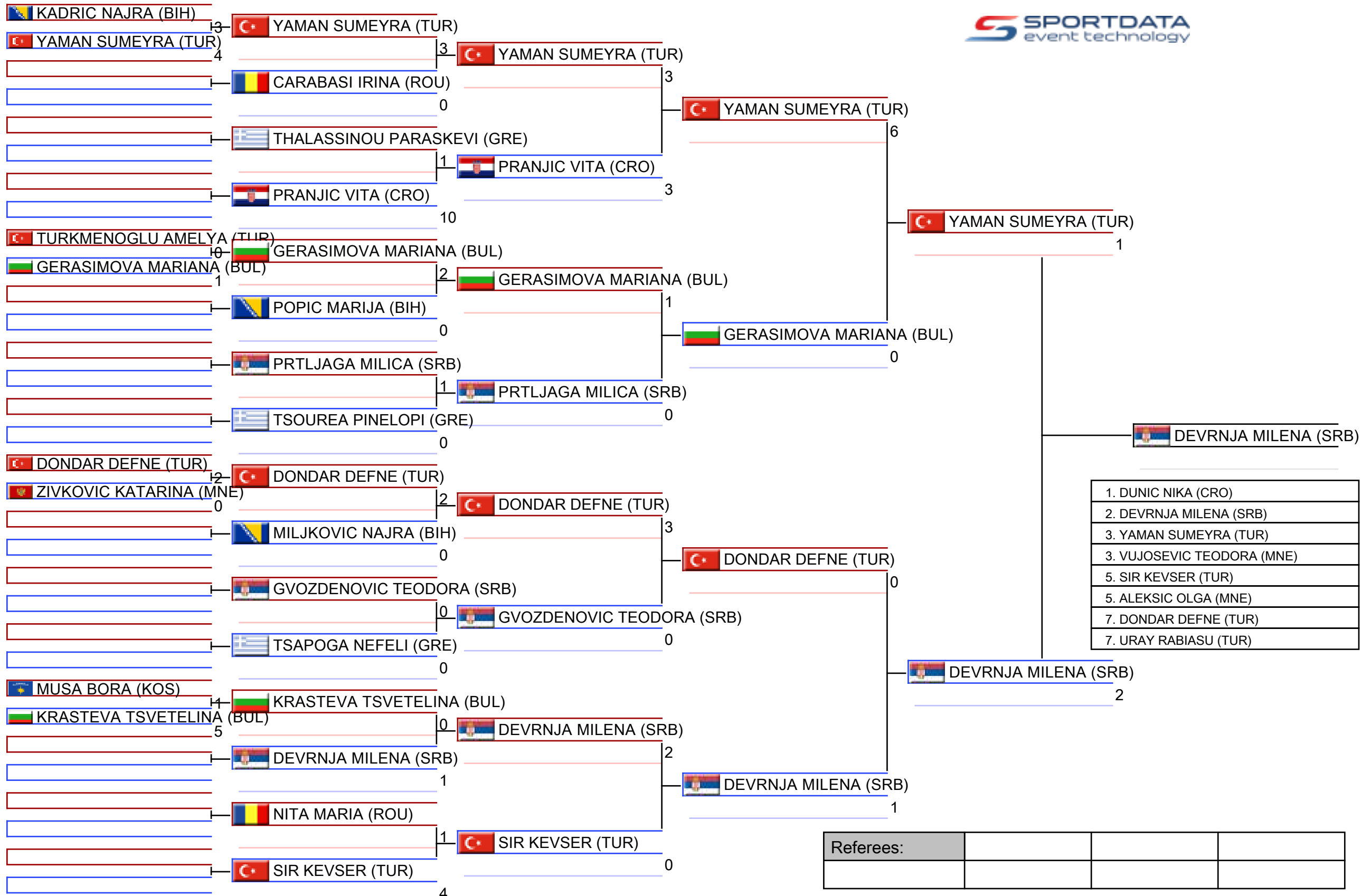

12 Yrs Kumite Female -45 kg

30th Balkan Karate Championships for Children 2026 - Istanbul, Basaksehir Spor Hall, Kayabaşı, TINAZTEPE CADDESİ NO:6, 34494 Başakşehir, İstanbul, TUR2026-05-29

Tatami
6 12:45

Pool
2/2

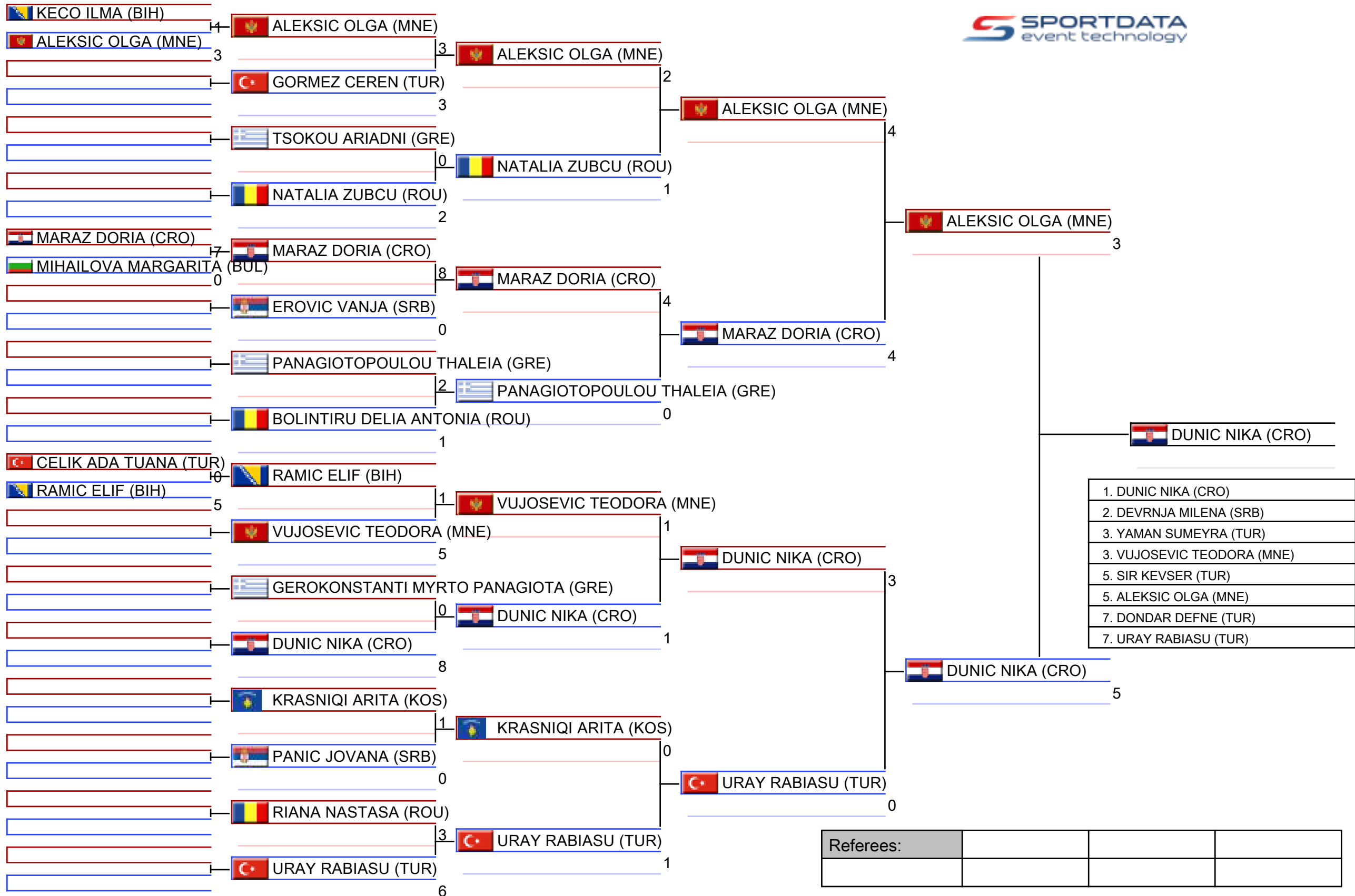

Referees:			

Pool winner-12 Yrs Kumite Female -45 kg

30th Balkan Karate Championships for Children 2026 - Istanbul, Basaksehir Spor Hall, Kayabaşı, TINAZTEPE CADDESİ NO:6, 34494 Başakşehir, İstanbul, TUR

Tatami

Pool

1/1

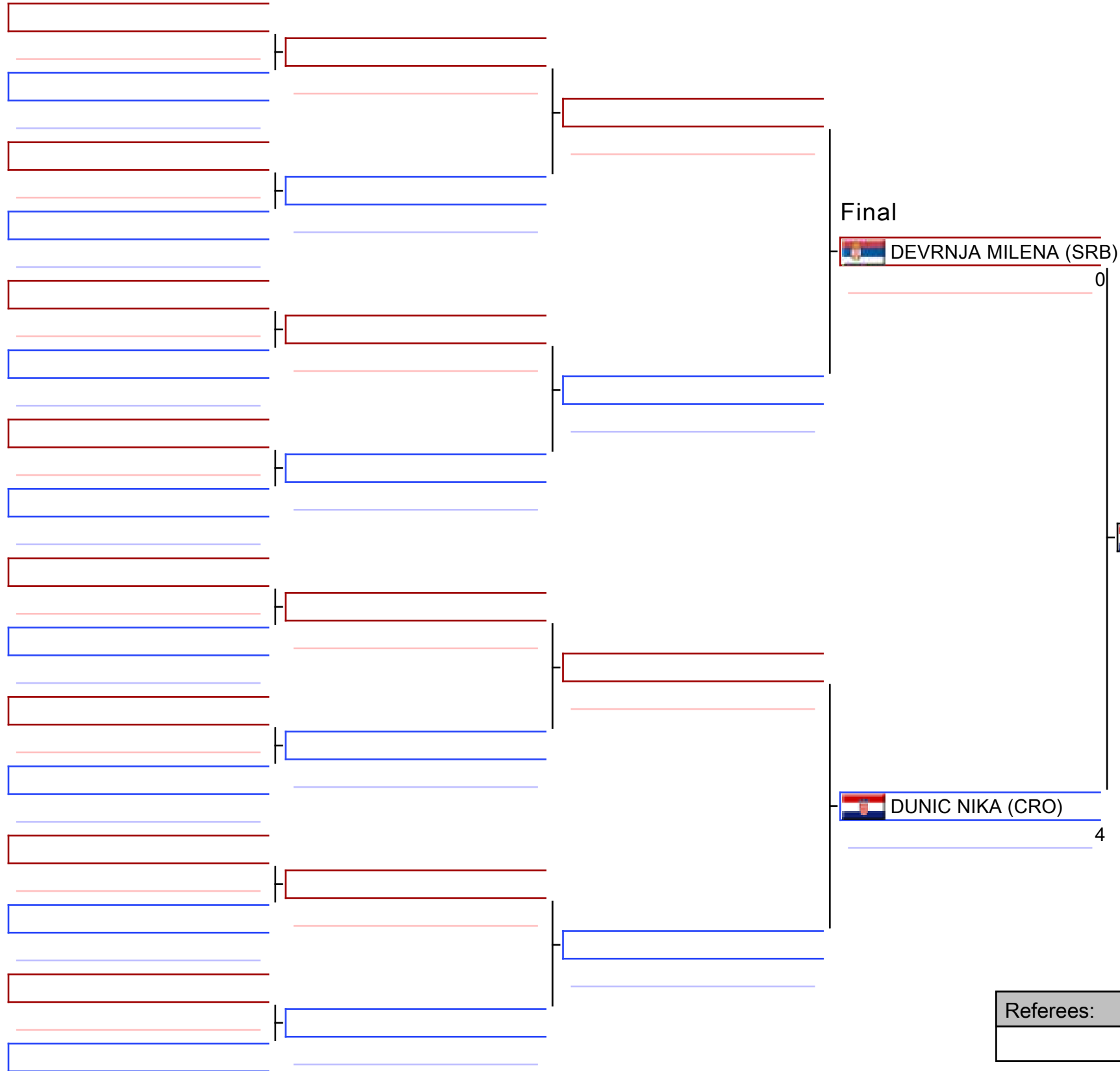

1. DUNIC NIKA (CRO)
2. DEVRNJA MILENA (SRB)
3. YAMAN SUMEYRA (TUR)
3. VUJOSEVIC TEODORA (MNE)
5. SIR KEVSER (TUR)
5. ALEKSIC OLGA (MNE)
7. DONDAR DEFNE (TUR)
7. URAY RABIASU (TUR)

Referees:			

12 Yrs Kumite Female -45 kg

30th Balkan Karate Championships for Children 2026 - Istanbul

2026-05-29

Tatami
6 13:50

Pool
1,2

(c)sportdata GmbH & Co KG 2000-2026 (2026-05-31 14:44) v 12.2.0 build 1 (2026-05-24 19:07 CET) License: Lazar Piper SRB (expire 2027-01-23)

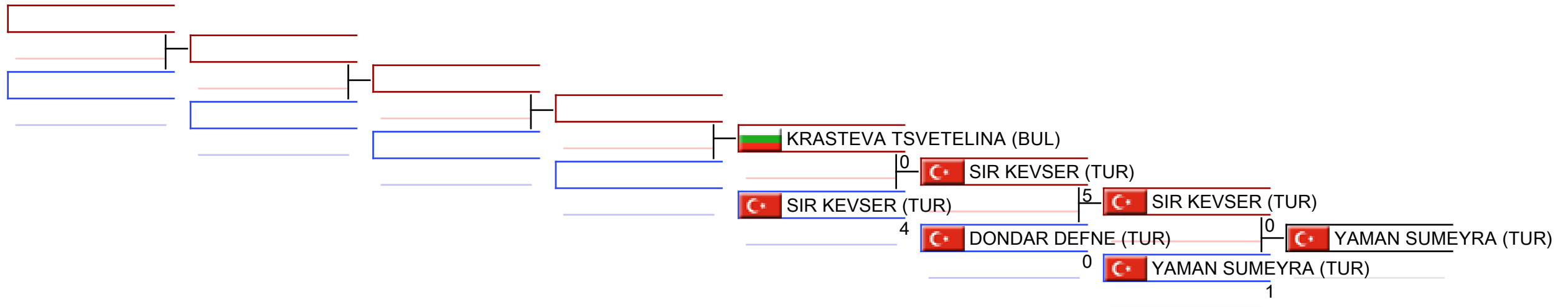

REPECHAGE: (1,2)

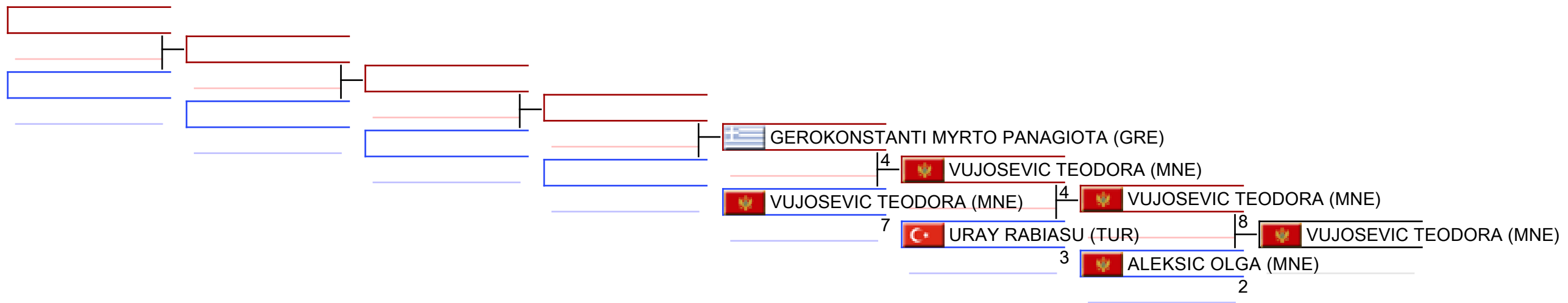

Referees:							
-----------	--	--	--	--	--	--	--

12 Yrs Kumite Female -50 kg

30th Balkan Karate Championships for Children 2026 - Istanbul, Basaksehir Spor Hall, Kayabaşı, TINAZTEPE CADDESİ NO:6, 34494 Başakşehir, İstanbul, TUR2026-05-31

Tatami

1 12:25

Pool

1/1

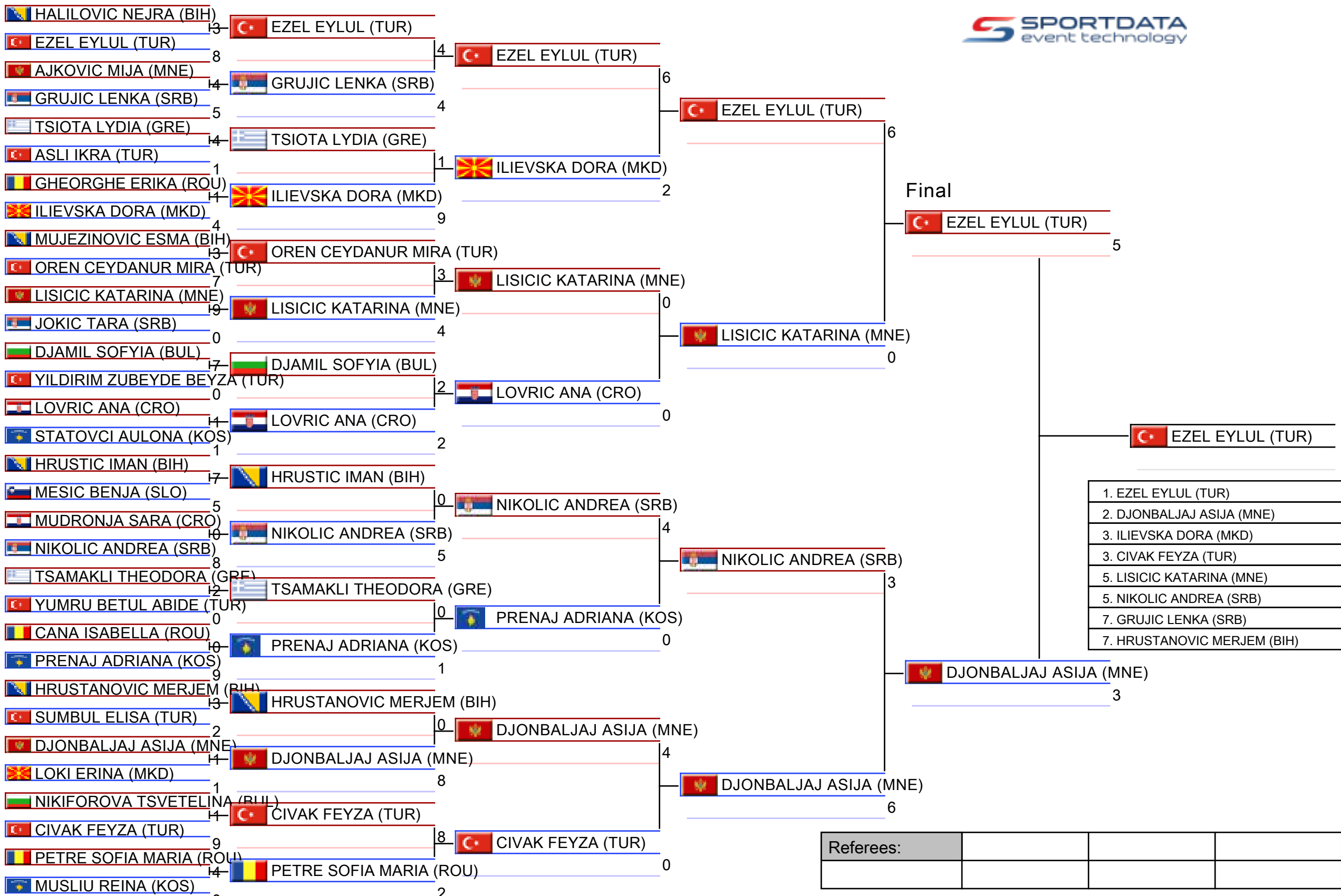

Referees:			

12 Yrs Kumite Female -50 kg

30th Balkan Karate Championships for Children 2026 - Istanbul

2026-05-31

Tatami
1 14:10

Pool
1

(c)sportdata GmbH & Co KG 2000-2026 (2026-05-31 14:44) v 12.2.0 build 1 (2026-05-24 19:07 CET) License: Lazar Piper SRB (expire 2027-01-23)

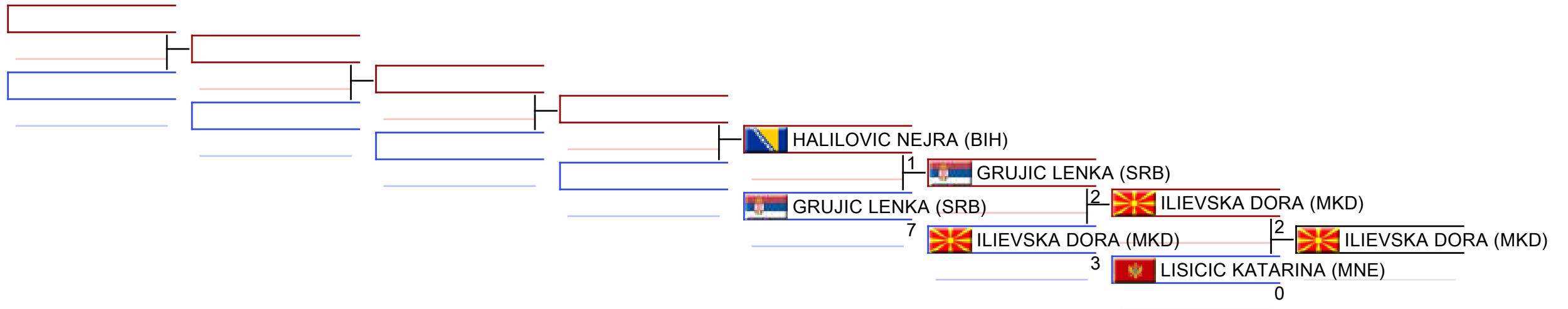

REPECHAGE: (1)

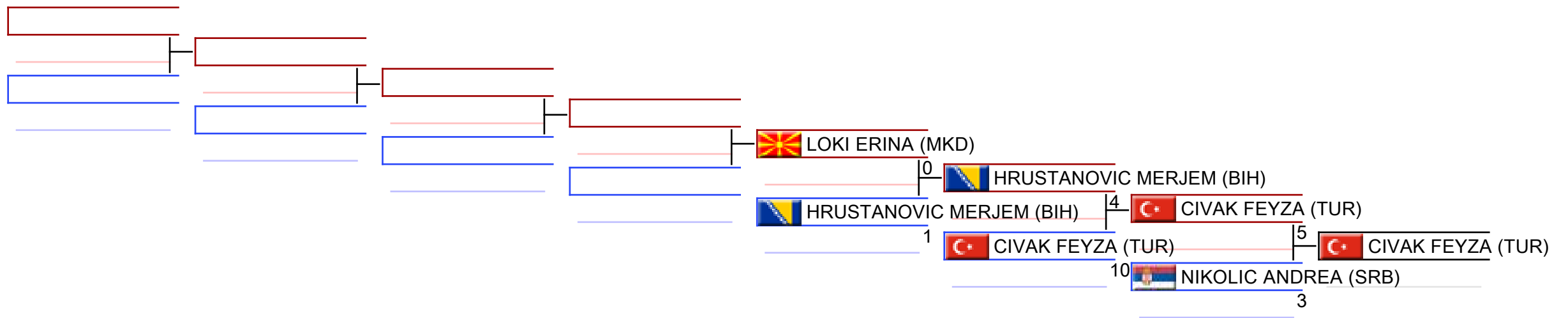

Referees:							
-----------	--	--	--	--	--	--	--

12 Yrs Kumite Female 50+ kg

30th Balkan Karate Championships for Children 2026 - Istanbul, Basaksehir Spor Hall, Kayabaşı, TINAZTEPE CADDESİ NO:6, 34494 Başakşehir, İstanbul, TUR2026-05-29

Tatami

5 15:45

Pool

1/1

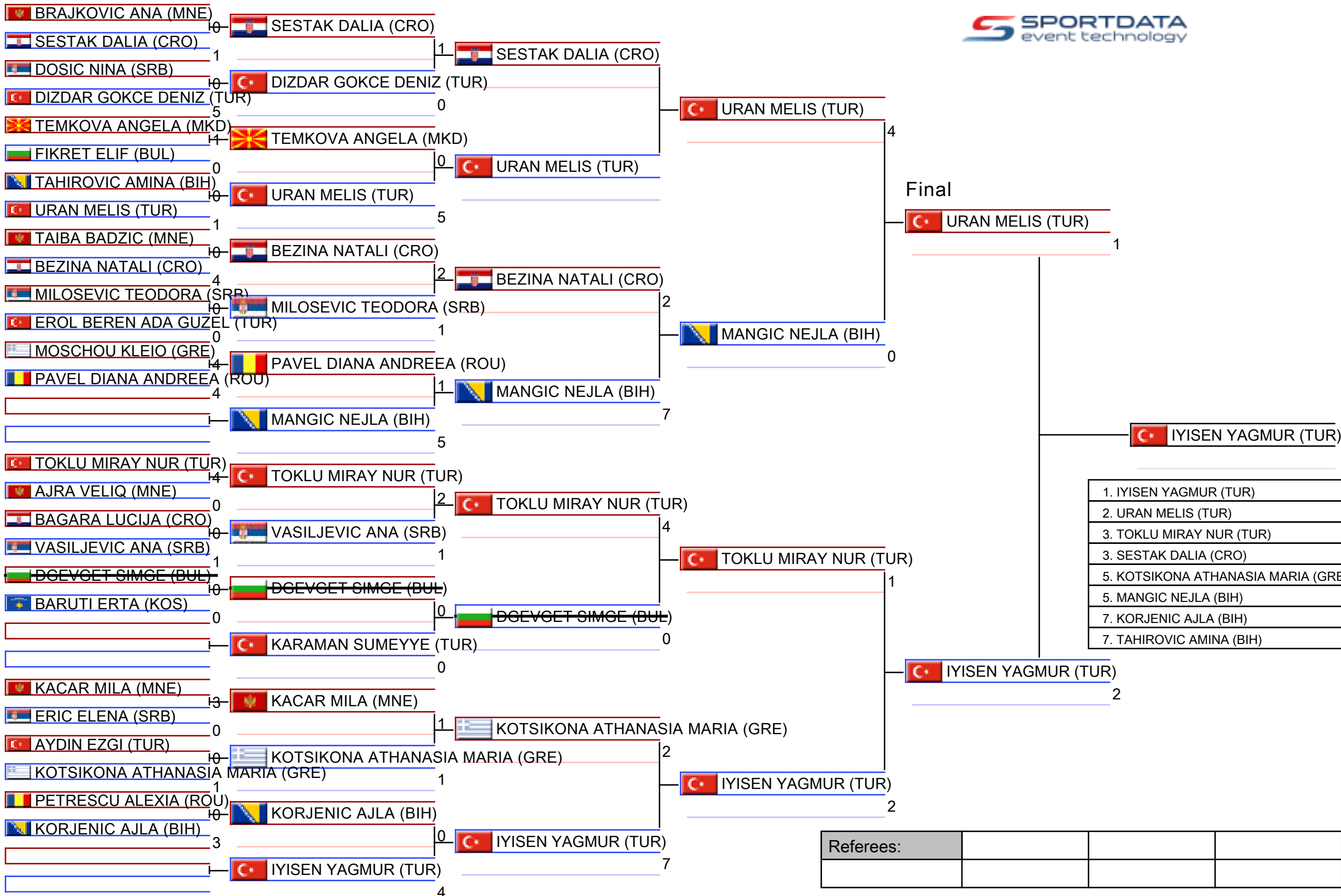

12 Yrs Kumite Female 50+ kg

30th Balkan Karate Championships for Children 2026 - Istanbul

2026-05-29

Tatami
5 17:10

Pool
1

(c)sportdata GmbH & Co KG 2000-2026 (2026-05-31 14:44) v 12.2.0 build 1 (2026-05-24 19:07 CET) License: Lazar Piper SRB (expire 2027-01-23)

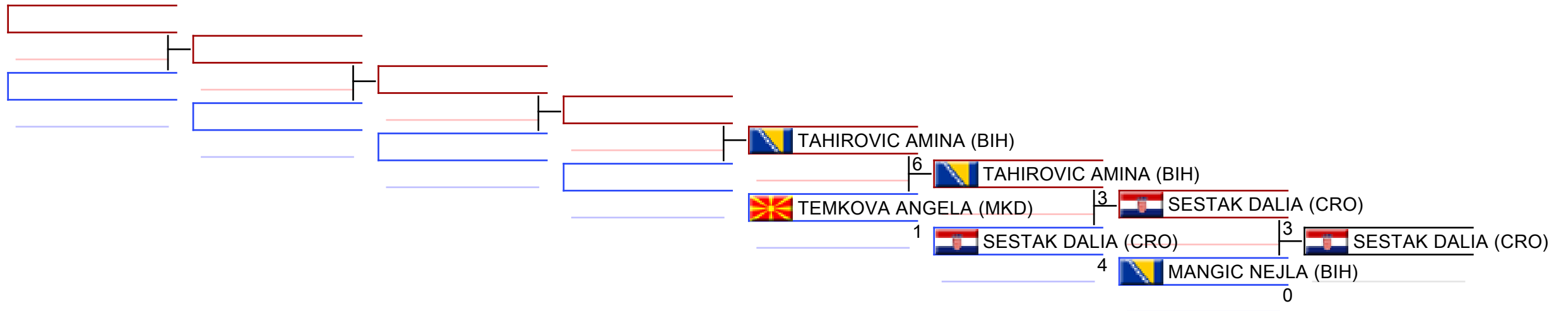

REPECHAGE: (1)

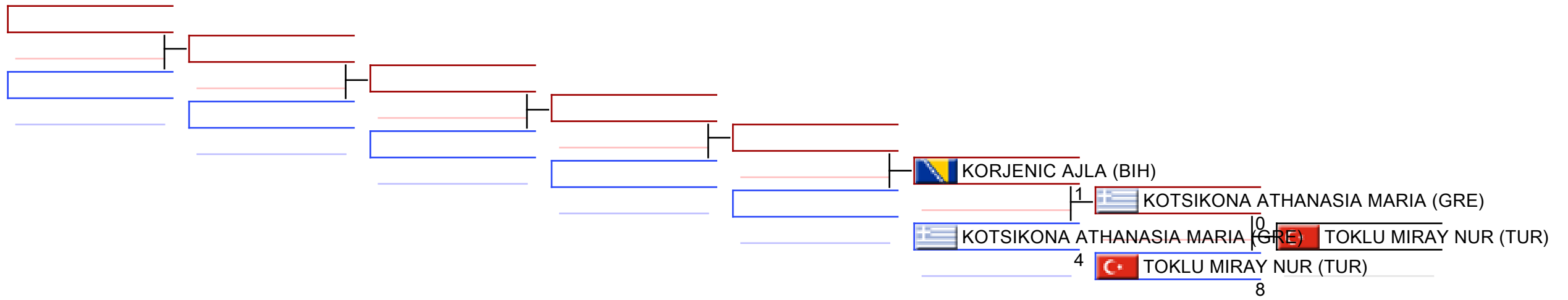

Referees:							
-----------	--	--	--	--	--	--	--

12 Yrs Kumite Male -37 kg

30th Balkan Karate Championships for Children 2026 - Istanbul, Basaksehir Spor Hall, Kayabaşı, TINAZTEPE CADDESİ NO:6, 34494 Başakşehir, İstanbul, TUR2026-05-30

Tatami

5 16:30

Pool

1/2

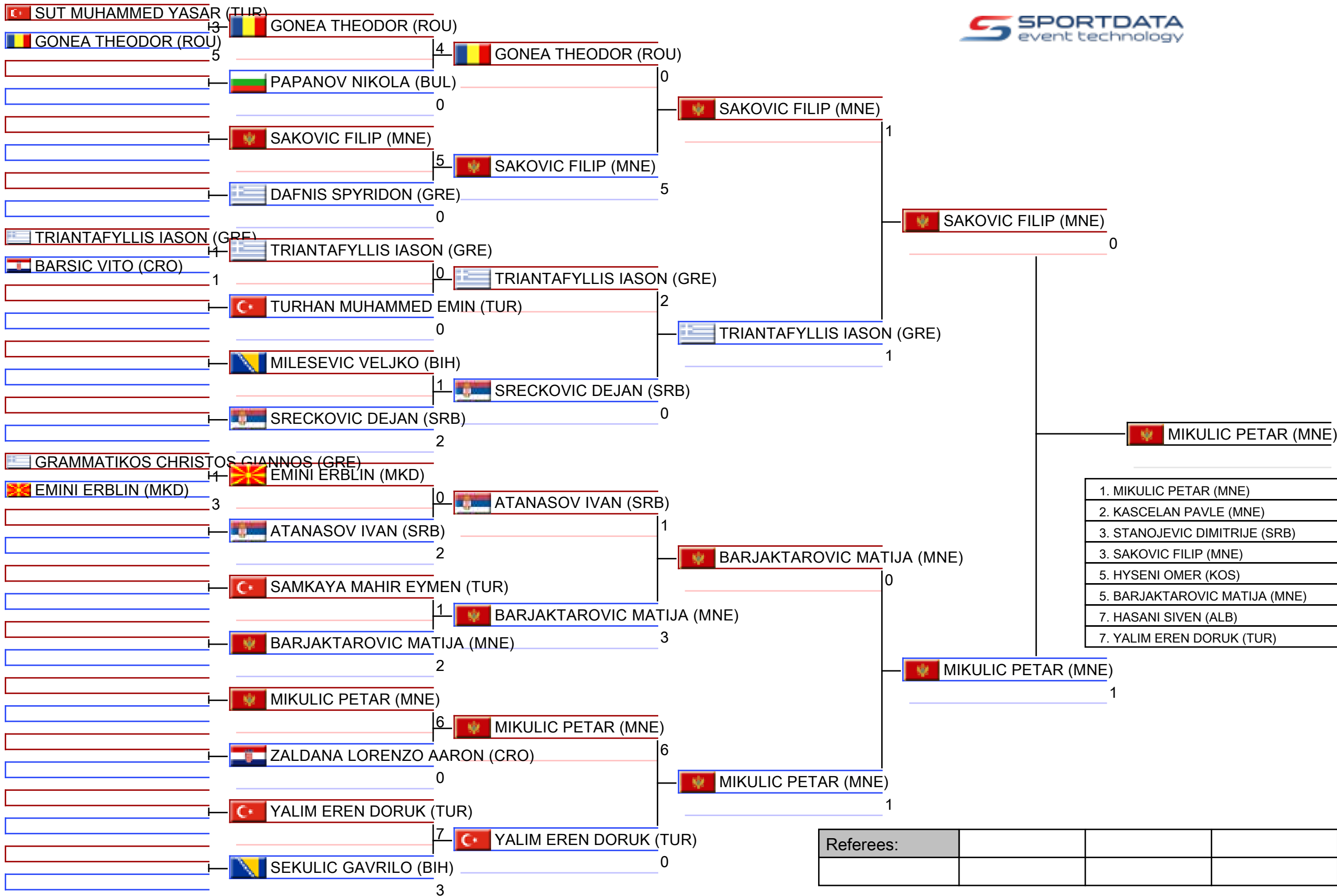

Referees:			

12 Yrs Kumite Male -37 kg

30th Balkan Karate Championships for Children 2026 - Istanbul, Basaksehir Spor Hall, Kayabaşı, TINAZTEPE CADDESİ NO:6, 34494 Başakşehir, İstanbul, TUR2026-05-30

Tatami

5 17:35

Pool

2/2

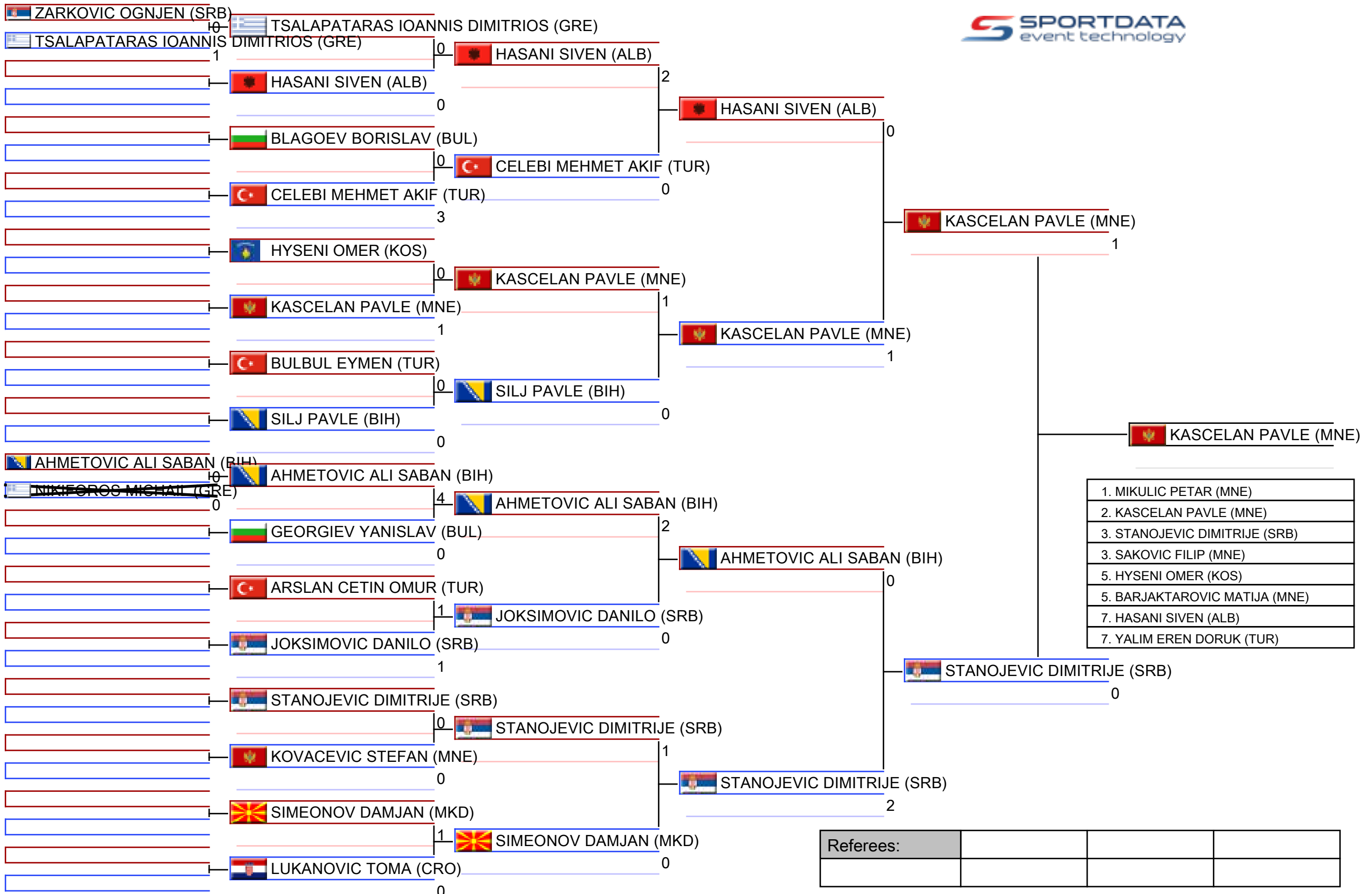

Referees:			

Pool winner-12 Yrs Kumite Male -37 kg

30th Balkan Karate Championships for Children 2026 - Istanbul, Basaksehir Spor Hall, Kayabaşı, TINAZTEPE CADDESİ NO:6, 34494 Başakşehir, İstanbul, TUR

Tatami

Pool

1/1

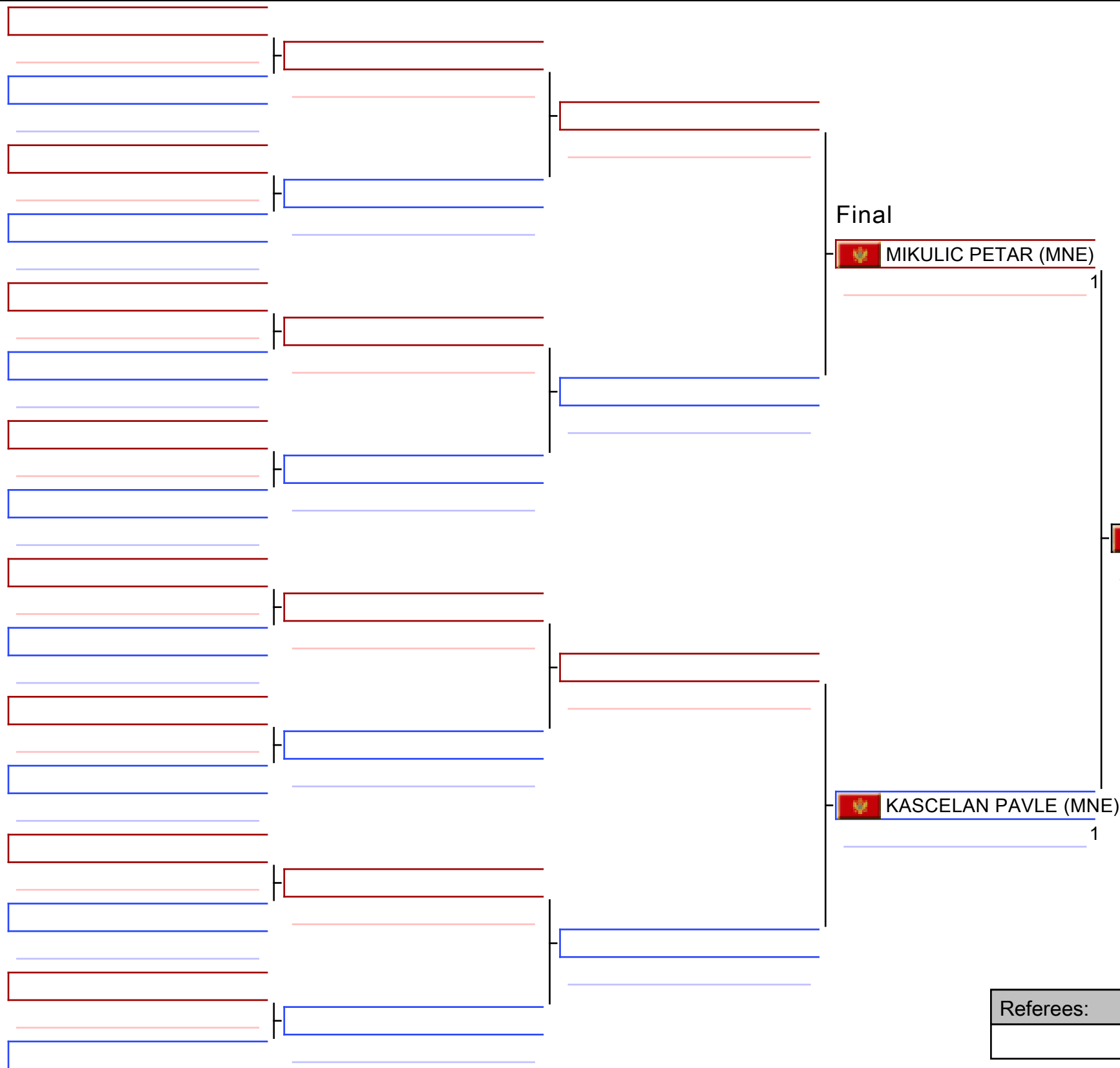

MIKULIC PETAR (MNE)

KASCELAN PAVLE (MNE)

1. MIKULIC PETAR (MNE)
2. KASCELAN PAVLE (MNE)
3. STANOJEVIC DIMITRIJE (SRB)
3. SAKOVIC FILIP (MNE)
5. HYSANI OMER (KOS)
5. BARJAKTAROVIC MATIJA (MNE)
7. HASANI SIVEN (ALB)
7. YALIM EREN DORUK (TUR)

Referees:			

12 Yrs Kumite Male -37 kg

30th Balkan Karate Championships for Children 2026 - Istanbul

2026-05-30

Tatami
5 18:35

Pool
1,2

(c)sportdata GmbH & Co KG 2000-2026 (2026-05-31 14:44) v 12.2.0 build 1 (2026-05-24 19:07 CET) License: Lazar Piper SRB (expire 2027-01-23)

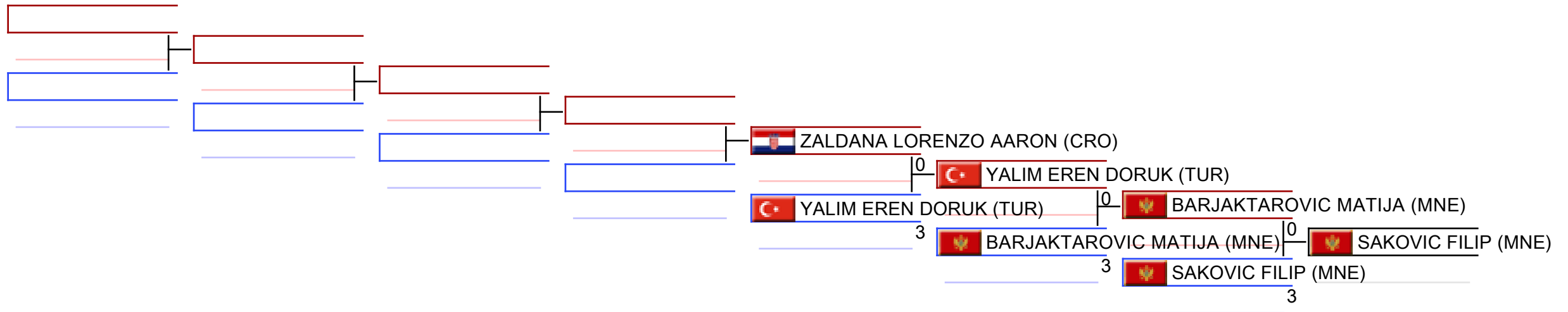

REPECHAGE: (1,2)

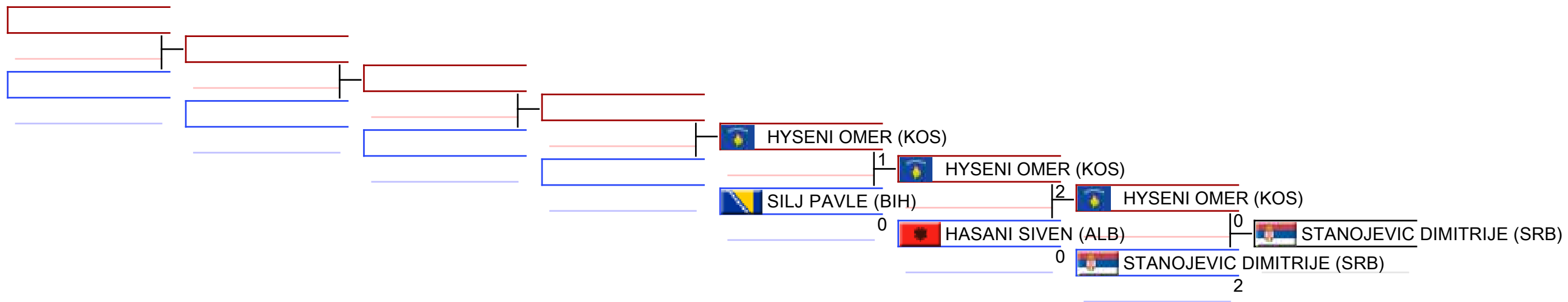

Referees:							
-----------	--	--	--	--	--	--	--

12 Yrs Kumite Male -42 kg

30th Balkan Karate Championships for Children 2026 - Istanbul, Basaksehir Spor Hall, Kayabaşı, TINAZTEPE CADDESİ NO:6, 34494 Başakşehir, İstanbul, TUR2026-05-30

Tatami

2 13:35

Pool

1/1

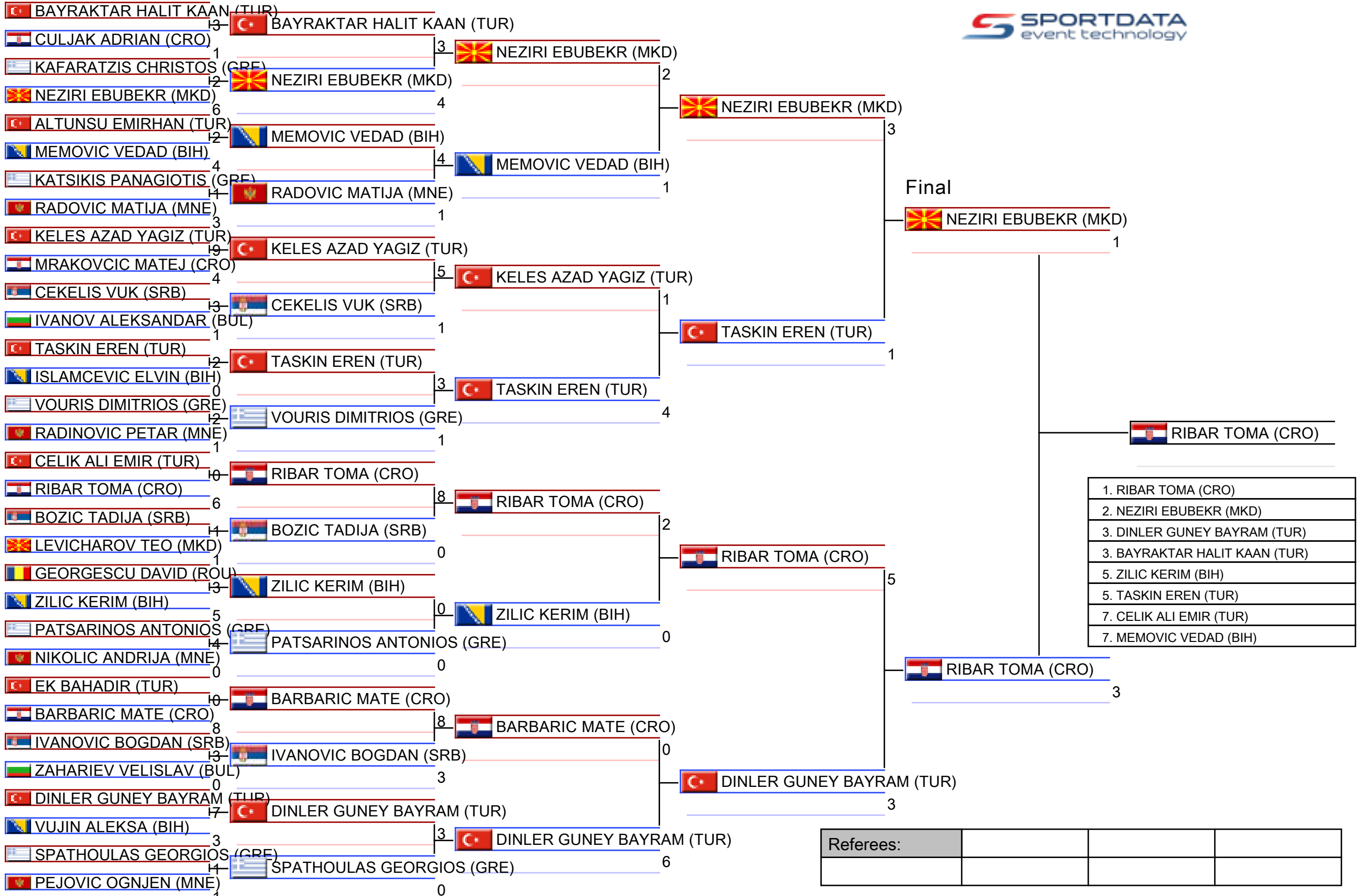

12 Yrs Kumite Male -42 kg

30th Balkan Karate Championships for Children 2026 - Istanbul

2026-05-30

Tatami
2 15:20

Pool
1

(c)sportdata GmbH & Co KG 2000-2026 (2026-05-31 14:44) v 12.2.0 build 1 (2026-05-24 19:07 CET) License: Lazar Piper SRB (expire 2027-01-23)

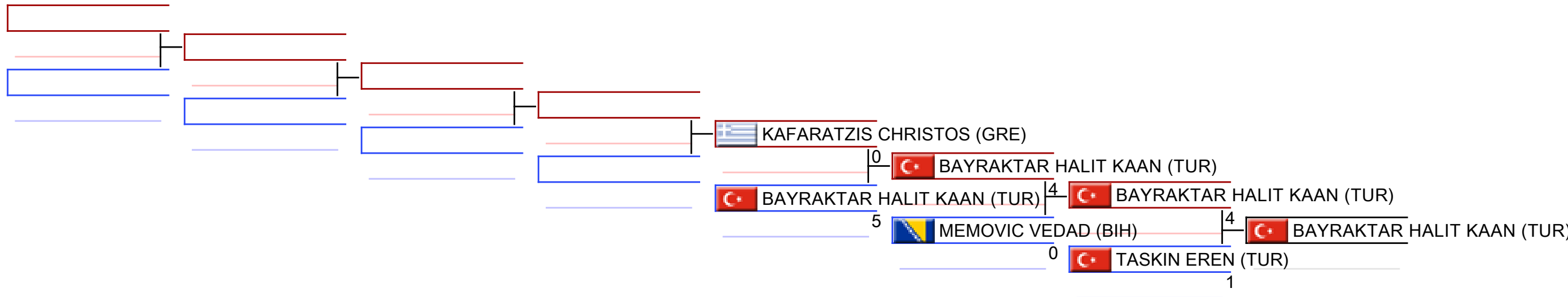

REPECHAGE: (1)

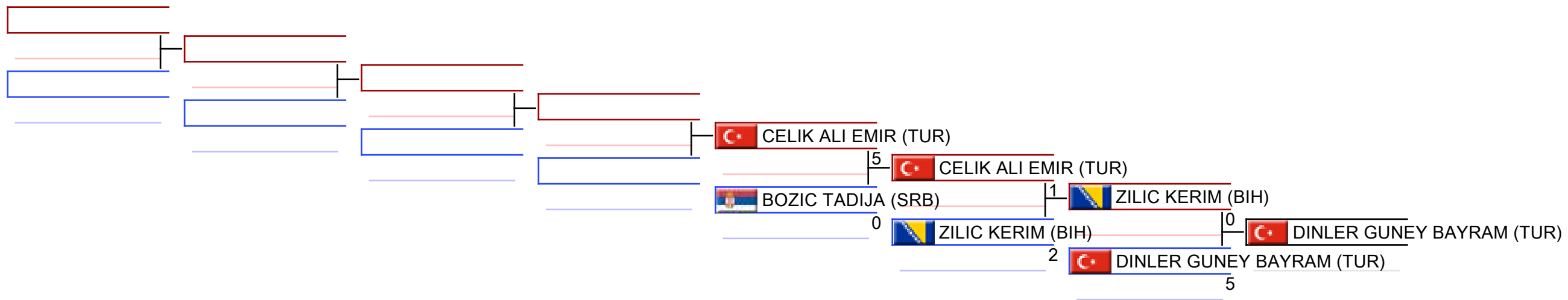

Referees:							
-----------	--	--	--	--	--	--	--

12 Yrs Kumite Male -47 kg

30th Balkan Karate Championships for Children 2026 - Istanbul, Basaksehir Spor Hall, Kayabaşı, TINAZTEPE CADDESİ NO:6, 34494 Başakşehir, İstanbul, TUR2026-05-31

Tatami

6 12:40

Pool

1/1

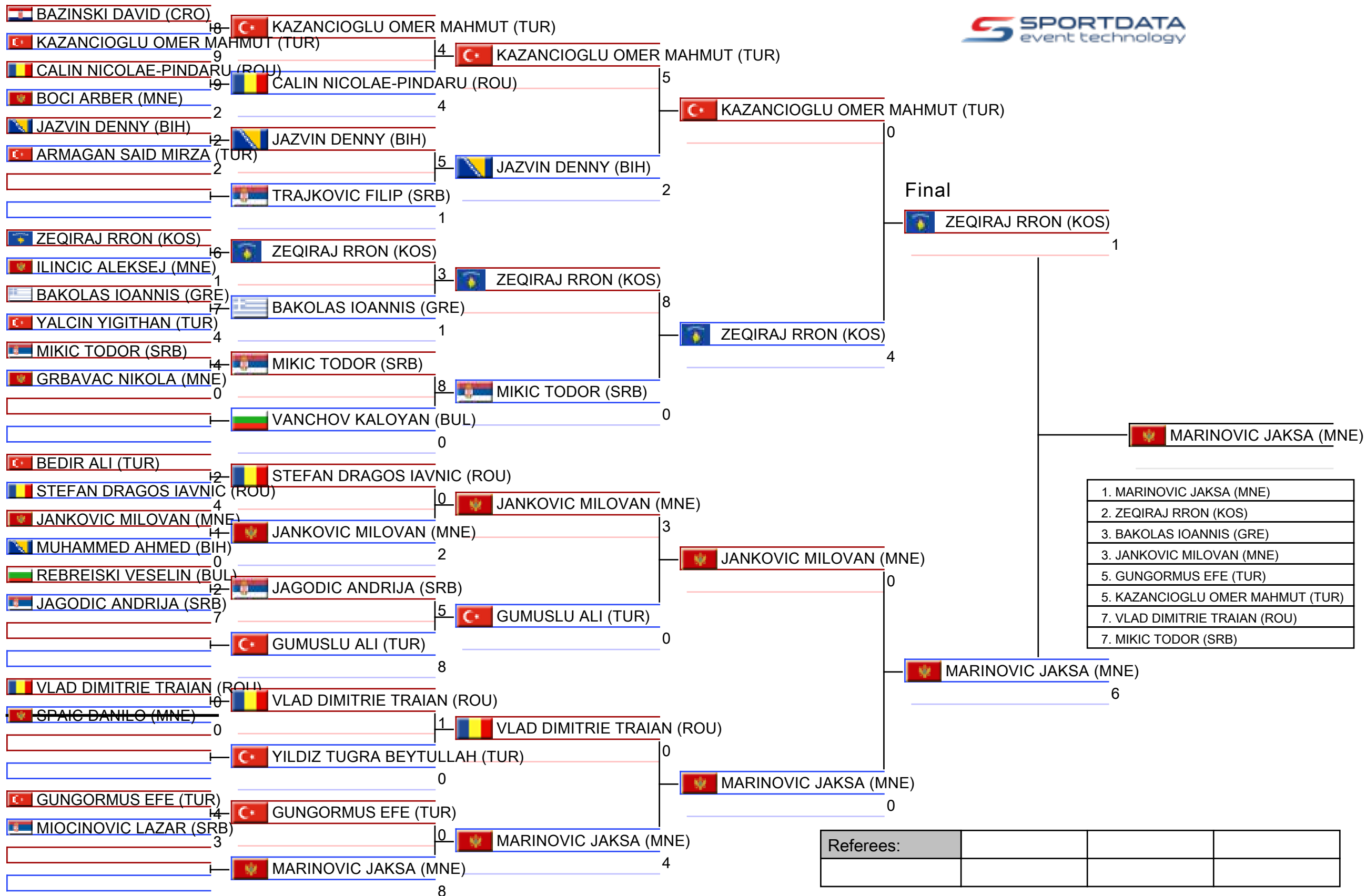

Referees:			

12 Yrs Kumite Male -47 kg

30th Balkan Karate Championships for Children 2026 - Istanbul

2026-05-31

Tatami
6 14:10

Pool
1

(c)sportdata GmbH & Co KG 2000-2026 (2026-05-31 14:44) v 12.2.0 build 1 (2026-05-24 19:07 CET) License: Lazar Piper SRB (expire 2027-01-23)

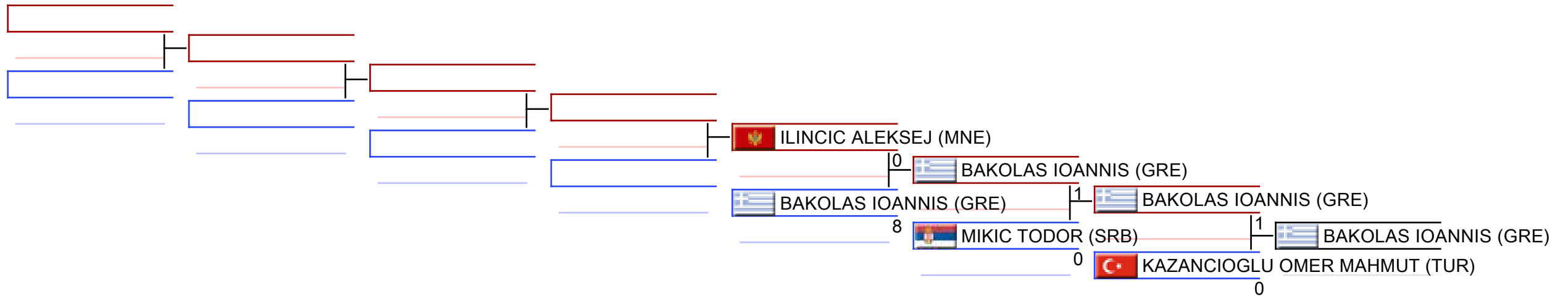

REPECHAGE: (1)

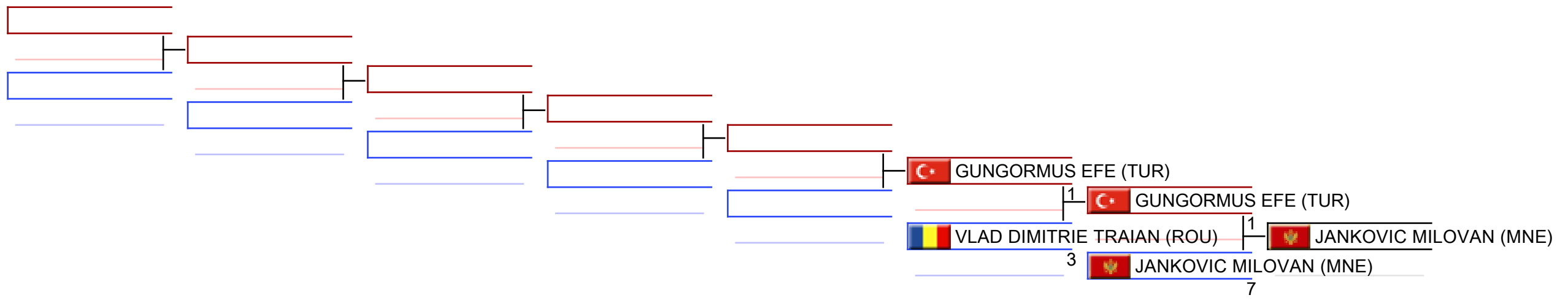

Referees:							
-----------	--	--	--	--	--	--	--

12 Yrs Kumite Male -52 kg

30th Balkan Karate Championships for Children 2026 - Istanbul, Basaksehir Spor Hall, Kayabaşı, TINAZTEPE CADDESİ NO:6, 34494 Başakşehir, İstanbul, TUR2026-05-30

Tatami

1 15:10

Pool

1/1

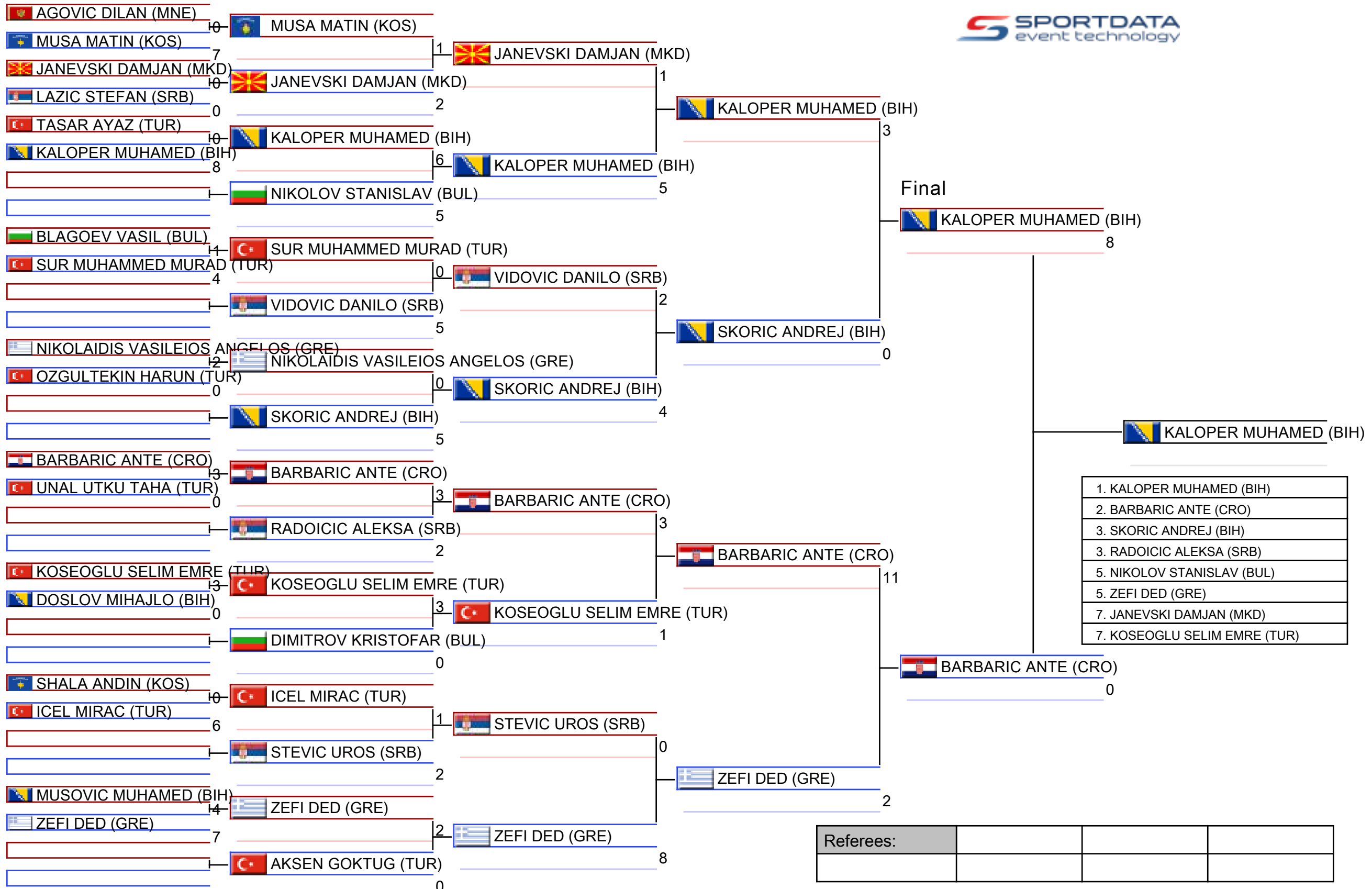

12 Yrs Kumite Male -52 kg

30th Balkan Karate Championships for Children 2026 - Istanbul

2026-05-30

Tatami
1 16:30

Pool
1

(c)sportdata GmbH & Co KG 2000-2026 (2026-05-31 14:44) v 12.2.0 build 1 (2026-05-24 19:07 CET) License: Lazar Piper SRB (expire 2027-01-23)

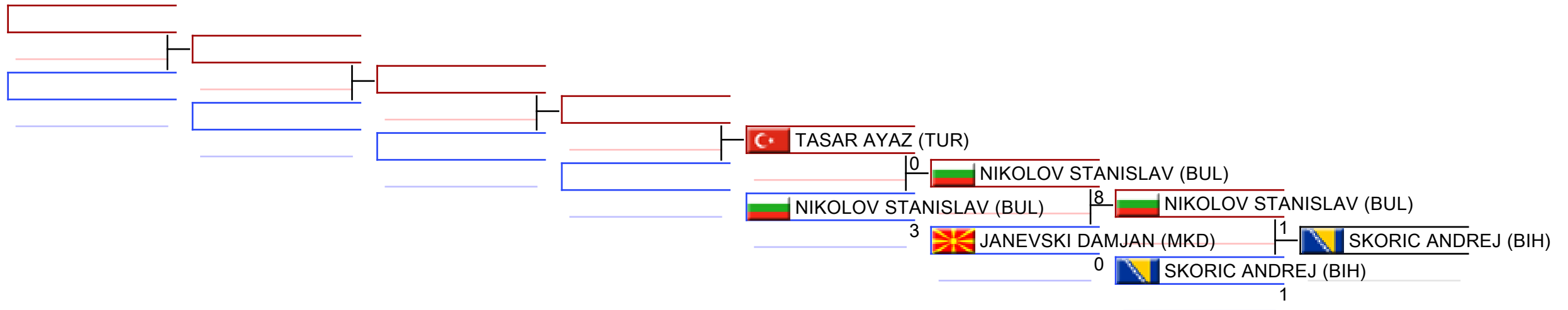

REPECHAGE: (1)

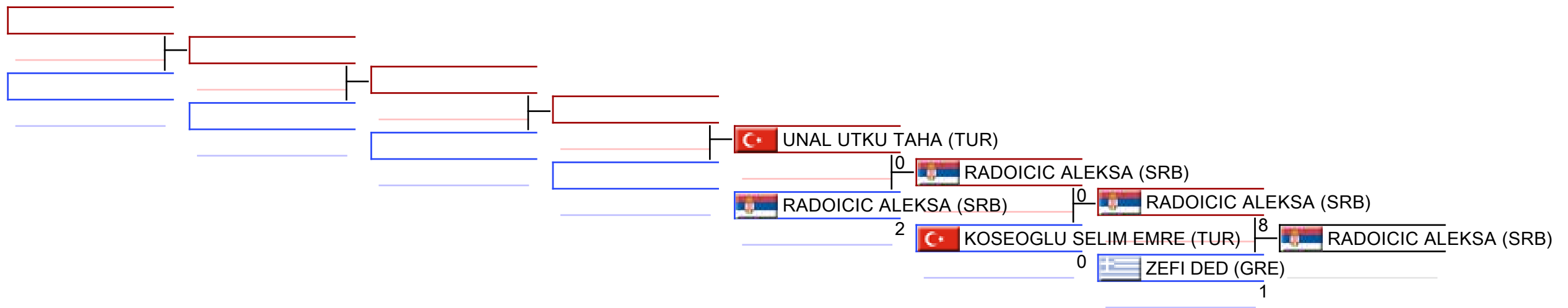

Referees:							
-----------	--	--	--	--	--	--	--

12 Yrs Kumite Male 52+ kg

30th Balkan Karate Championships for Children 2026 - Istanbul, Basaksehir Spor Hall, Kayabaşı, TINAZTEPE CADDESİ NO:6, 34494 Başakşehir, İstanbul, TUR2026-05-30

Tatami
3 13:15

Pool
1/2

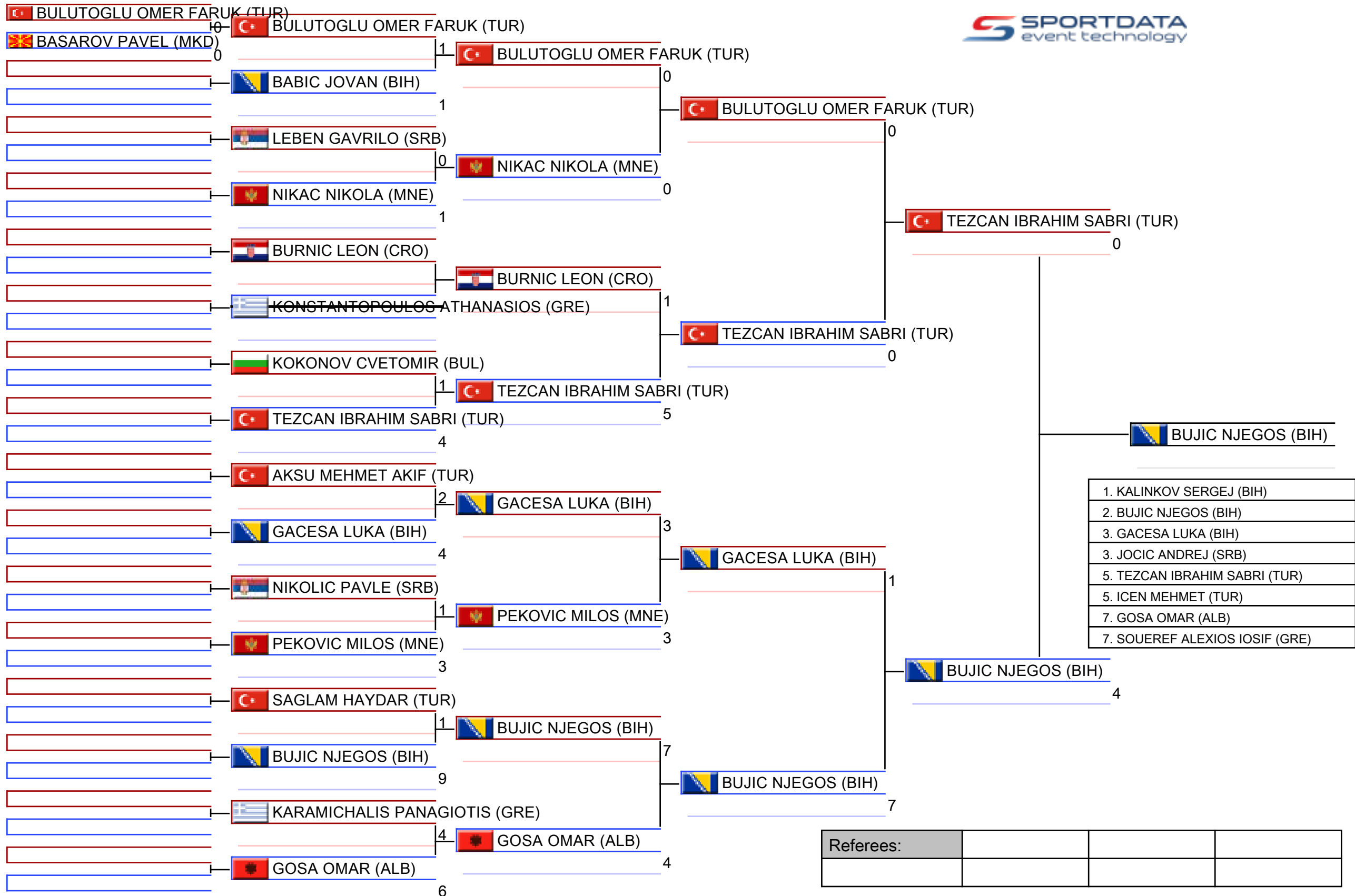

12 Yrs Kumite Male 52+ kg

30th Balkan Karate Championships for Children 2026 - Istanbul, Basaksehir Spor Hall, Kayabaşı, TINAZTEPE CADDESİ NO:6, 34494 Başakşehir, İstanbul, TUR2026-05-30

Tatami

3 14:40

Pool

2/2

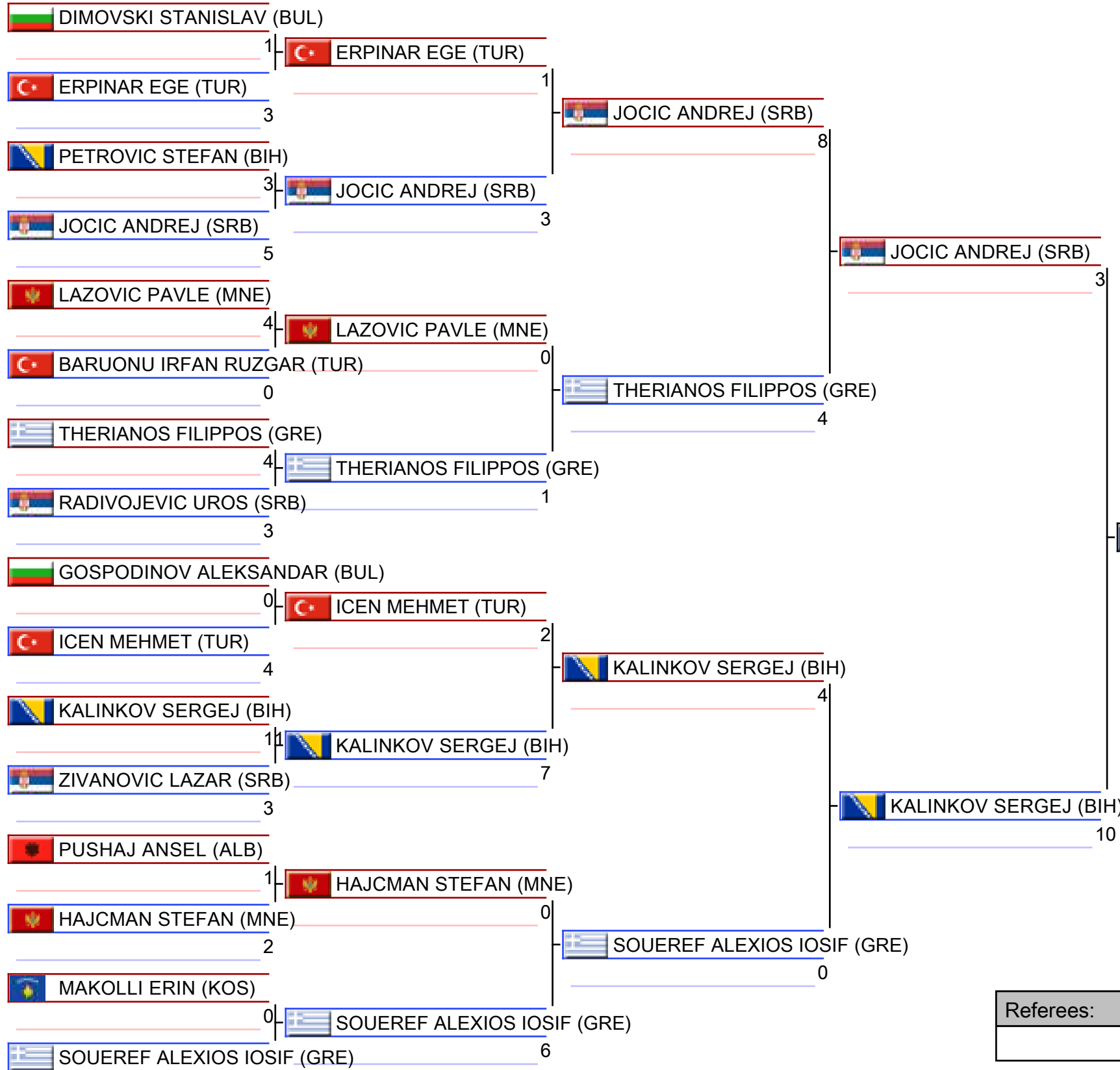

1. KALINKOV SERGEJ (BIH)
2. BUJIC NJEGOS (BIH)
3. GACESA LUKA (BIH)
3. JOCIC ANDREJ (SRB)
5. TEZCAN IBRAHIM SABRI (TUR)
5. ICEN MEHMET (TUR)
7. GOSA OMAR (ALB)
7. SOUEREF ALEXIOS IOSIF (GRE)

Referees:			

Pool winner-12 Yrs Kumite Male 52+ kg

30th Balkan Karate Championships for Children 2026 - Istanbul, Basaksehir Spor Hall, Kayabaşı, TINAZTEPE CADDESİ NO:6, 34494 Başakşehir, İstanbul, TUR

Tatami

Pool

1/1

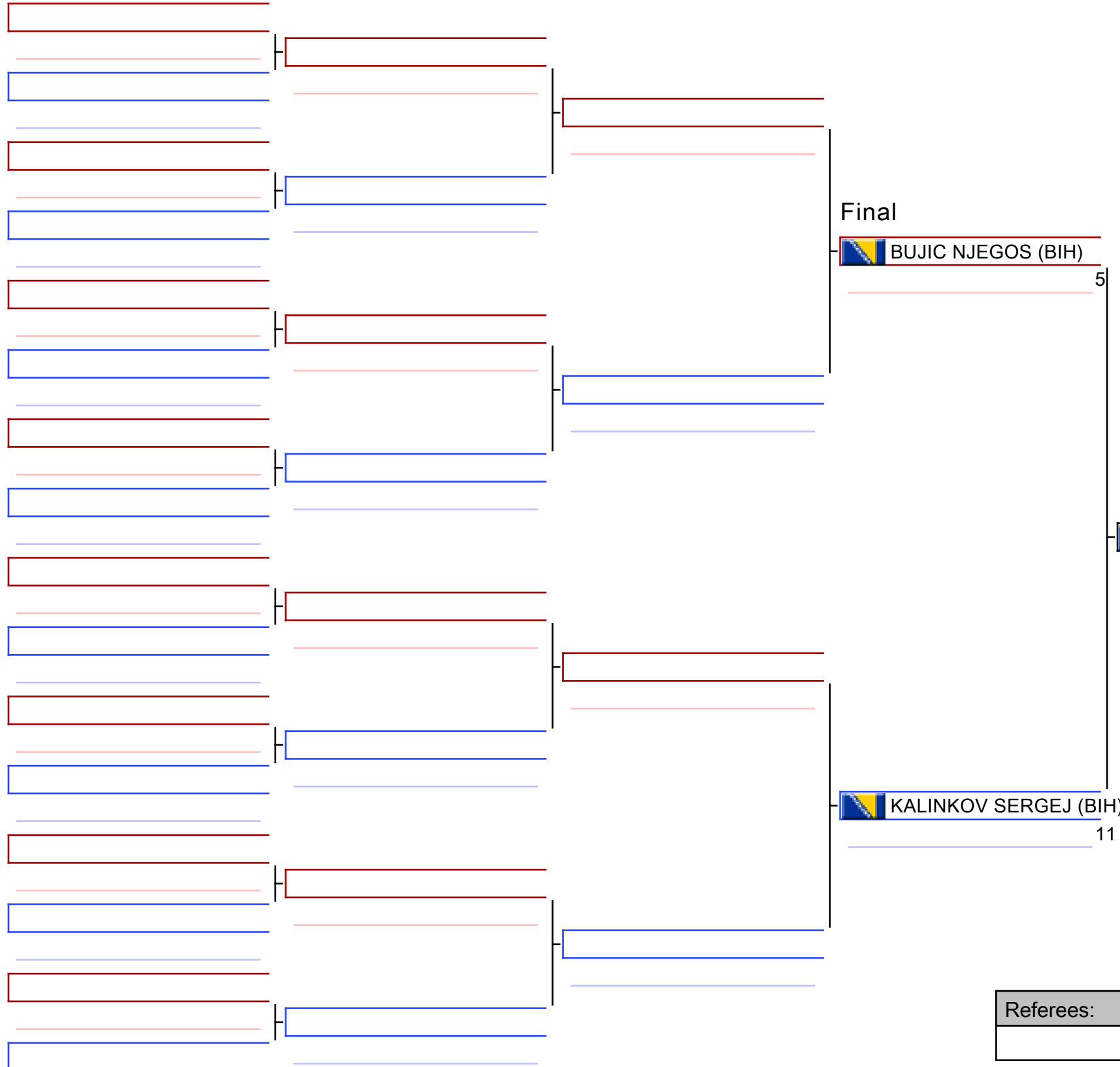

Final

BUJIC NJEGOS (BIH)
5

KALINKOV SERGEJ (BIH)

KALINKOV SERGEJ (BIH)
11

1. KALINKOV SERGEJ (BIH)
2. BUJIC NJEGOS (BIH)
3. GACESA LUKA (BIH)
3. JOCIC ANDREJ (SRB)
5. TEZCAN IBRAHIM SABRI (TUR)
5. ICEN MEHMET (TUR)
7. GOSA OMAR (ALB)
7. SOUEREFF ALEXIOS IOSIF (GRE)

Referees:			

12 Yrs Kumite Male 52+ kg

30th Balkan Karate Championships for Children 2026 - Istanbul

2026-05-30

Tatami
3 15:35

Pool
1,2

(c)sportdata GmbH & Co KG 2000-2026 (2026-05-31 14:44) v 12.2.0 build 1 (2026-05-24 19:07 CET) License: Lazar Piper SRB (expire 2027-01-23)

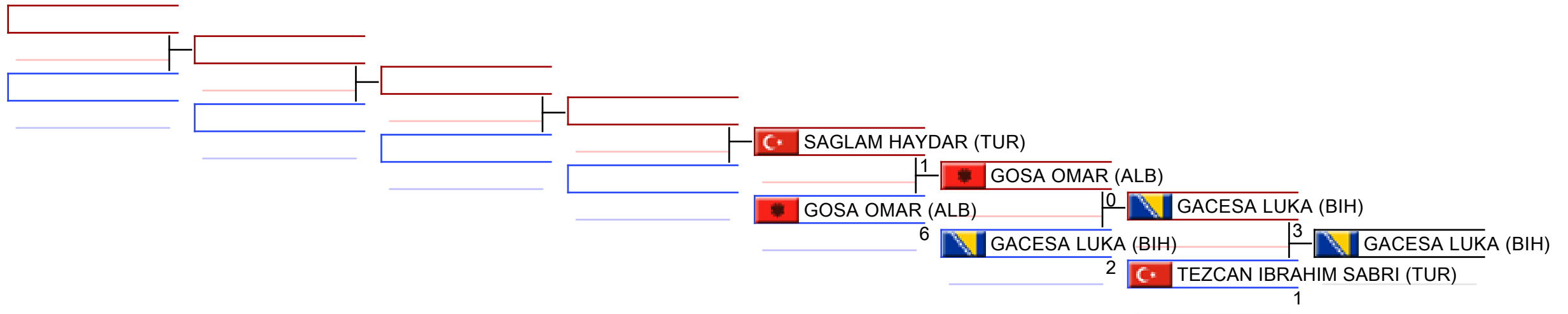

REPECHAGE: (1,2)

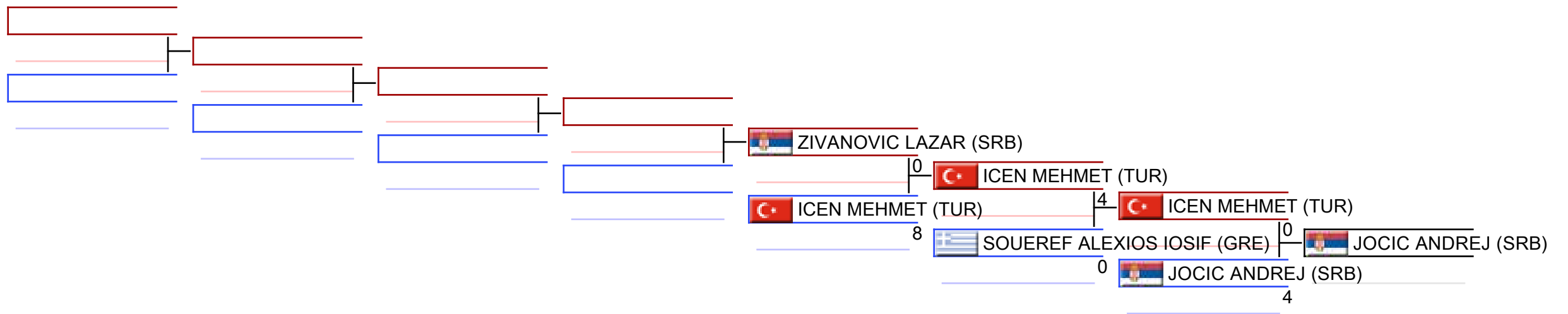

Referees:							
-----------	--	--	--	--	--	--	--

13 Yrs Kata Individual Female

30th Balkan Karate Championships for Children 2026 - Istanbul, Basaksehir Spor Hall, Kayabaşı, TINAZTEPE CADDESİ NO:6, 34494 Başakşehir, İstanbul, TUR2026-05-30

Tatami

1 09:00

Pool

1/2

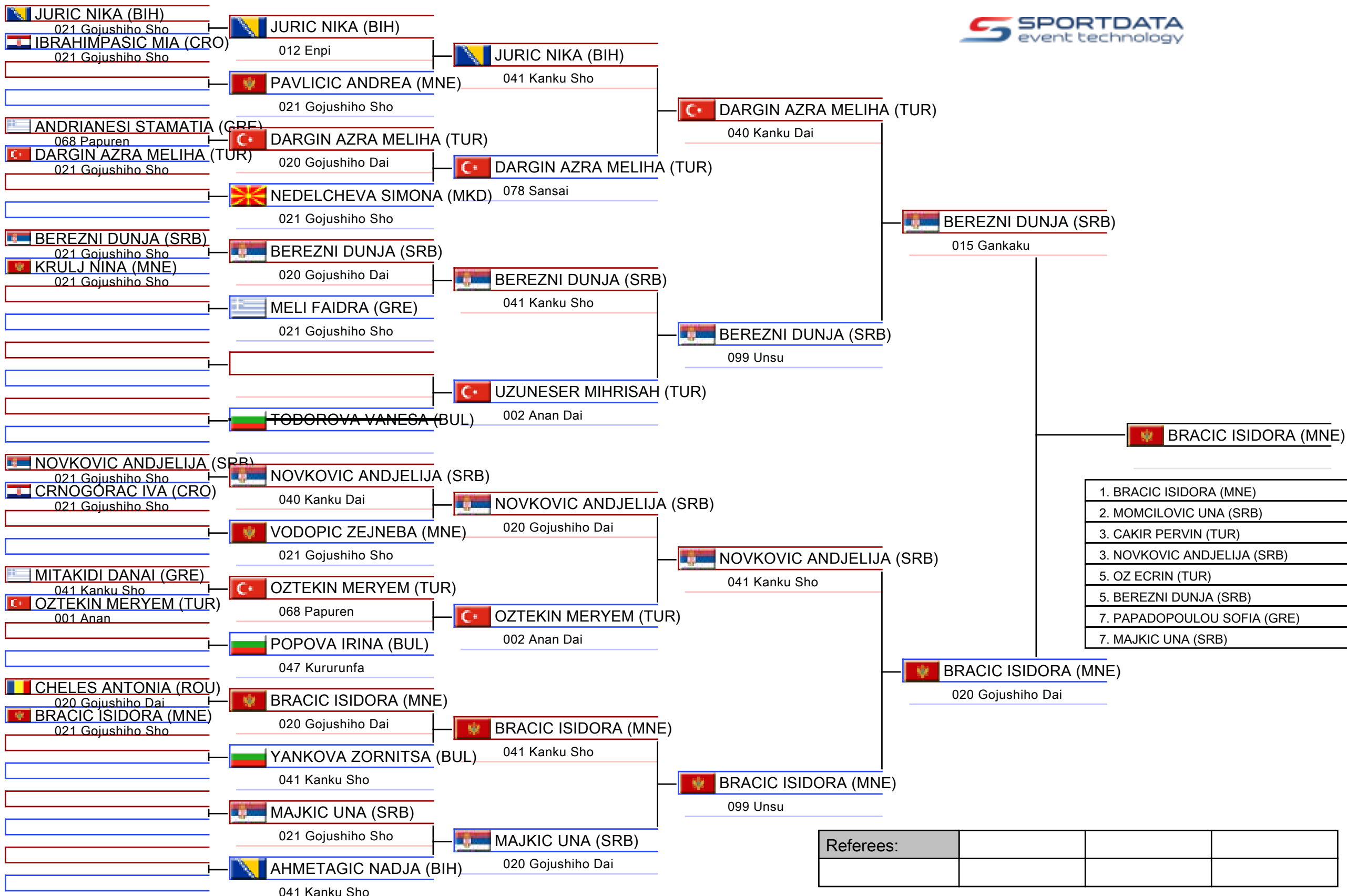

Referees:			

13 Yrs Kata Individual Female

30th Balkan Karate Championships for Children 2026 - Istanbul, Basaksehir Spor Hall, Kayabaşı, TINAZTEPE CADDESİ NO:6, 34494 Başakşehir, İstanbul, TUR2026-05-30

Tatami
2 09:00

Pool
2/2

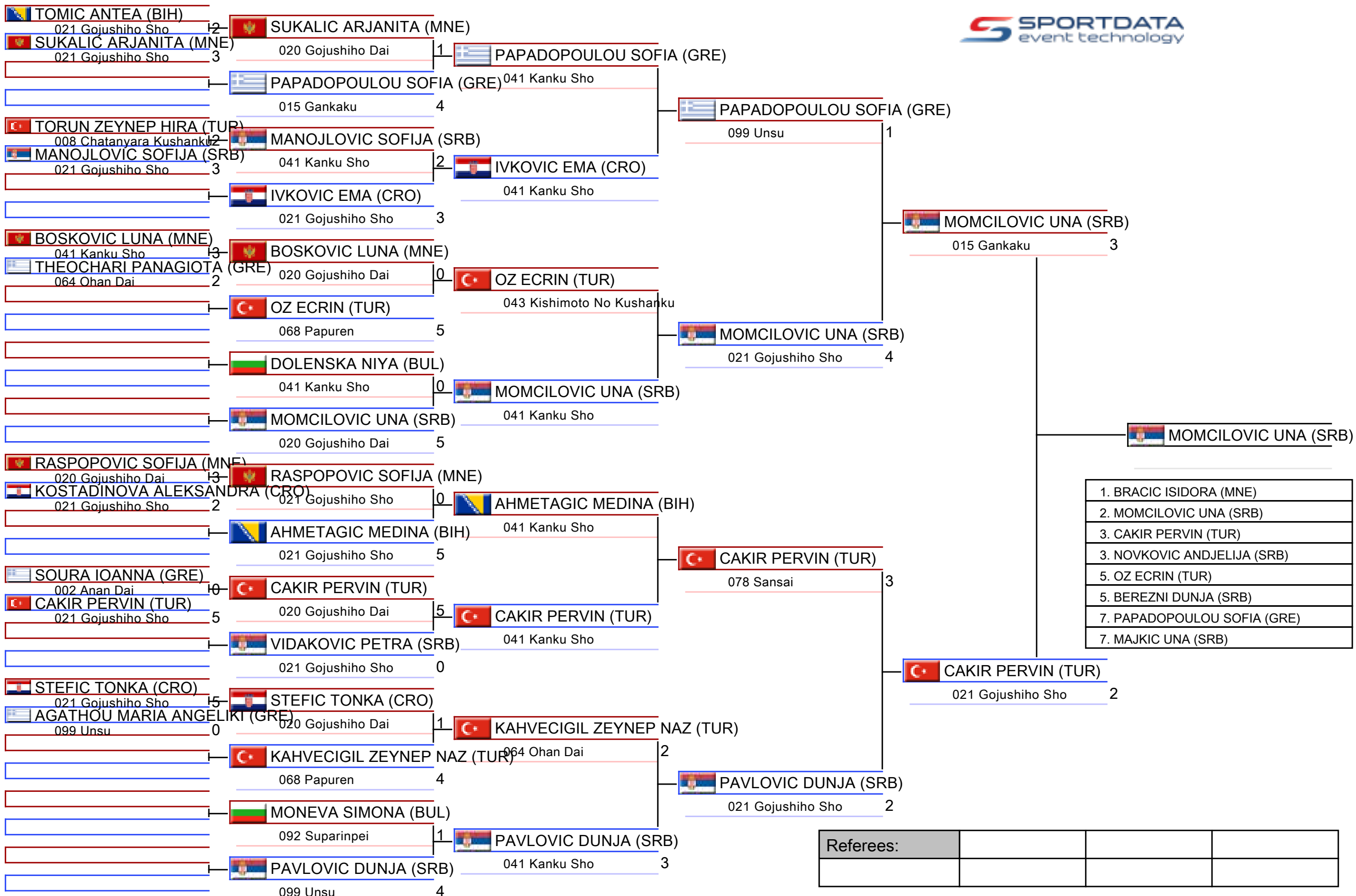

Referees:			

Pool winner-13 Yrs Kata Individual Female

30th Balkan Karate Championships for Children 2026 - Istanbul, Basaksehir Spor Hall, Kayabaşı, TINAZTEPE CADDESİ NO:6, 34494 Başakşehir, İstanbul, TUR

Tatami

Pool
1/1

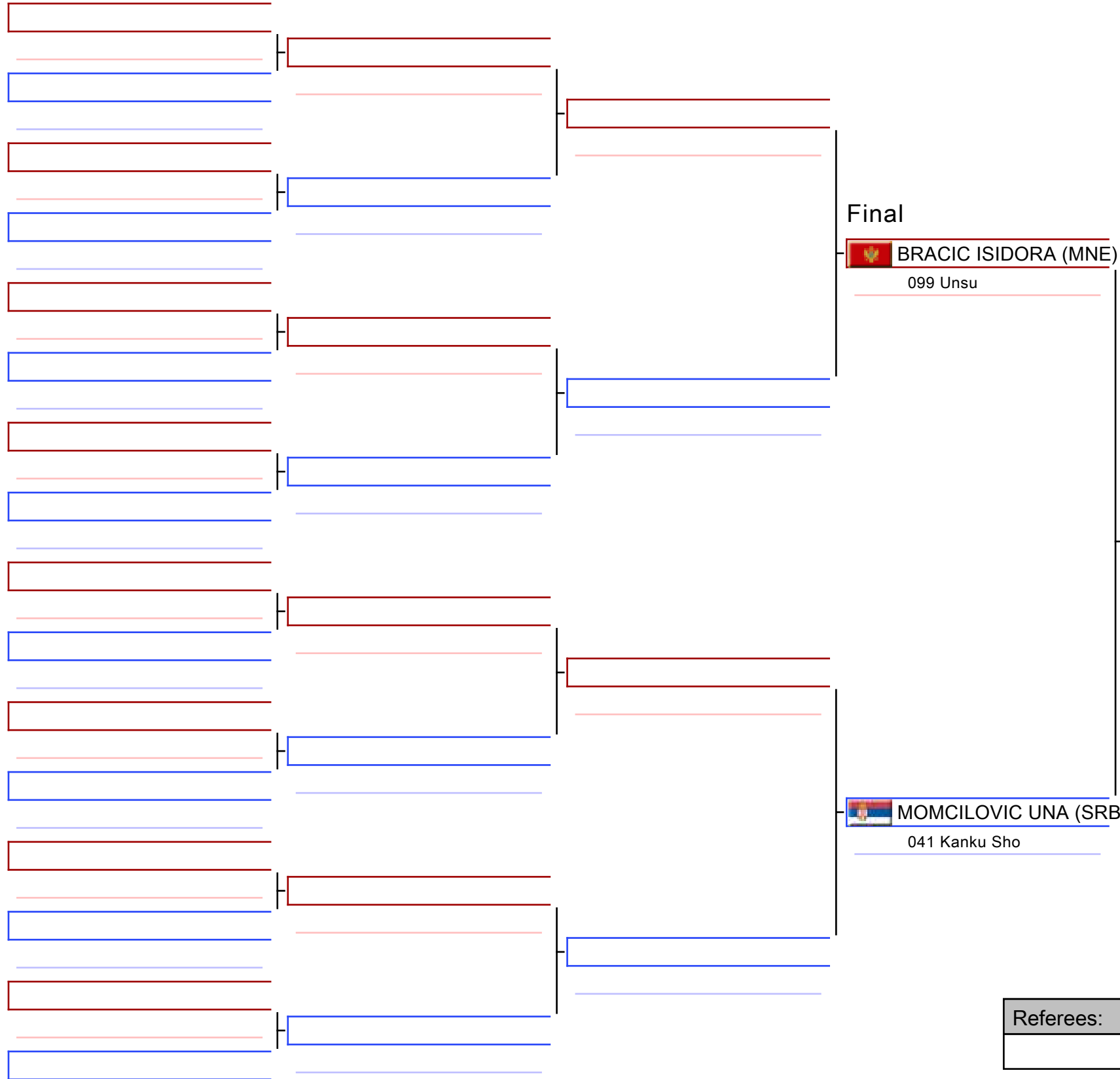

Final

BRACIC ISIDORA (MNE)
099 Unsu

BRACIC ISIDORA (MNE)

MOMCILOVIC UNA (SRB)
041 Kanku Sho

1. BRACIC ISIDORA (MNE)
2. MOMCILOVIC UNA (SRB)
3. CAKIR PERVIN (TUR)
3. NOVKOVIC ANDJELIJA (SRB)
5. OZ ECRIN (TUR)
5. BEREZNI DUNJA (SRB)
7. PAPADOPOULOU SOFIA (GRE)
7. MAJKIC UNA (SRB)

Referees:			

13 Yrs Kata Individual Female

30th Balkan Karate Championships for Children 2026 - Istanbul

2026-05-30

Tatami
1 12:20

Pool
1,2

(c)sportdata GmbH & Co KG 2000-2026 (2026-05-31 14:44) v 12.2.0 build 1 (2026-05-24 19:07 CET) License: Lazar Piper SRB (expire 2027-01-23)

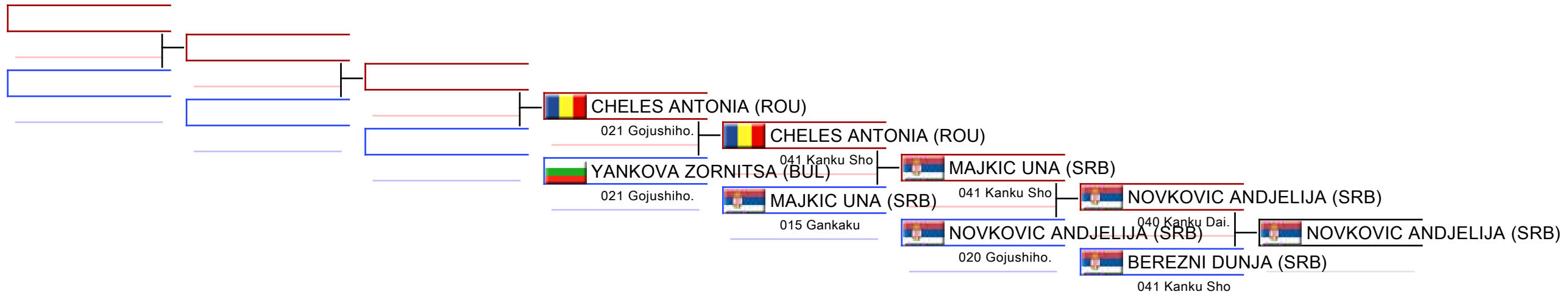

REPECHAGE: (1,2)

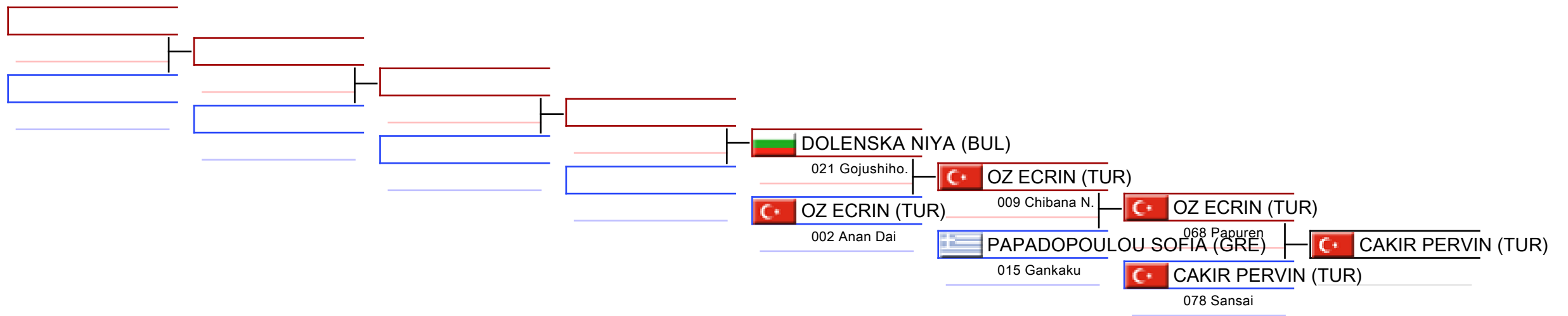

Referees:							
-----------	--	--	--	--	--	--	--

13 Yrs Kata Individual Male

30th Balkan Karate Championships for Children 2026 - Istanbul, Basaksehir Spor Hall, Kayabaşı, TINAZTEPE CADDESİ NO:6, 34494 Başakşehir, İstanbul, TUR2026-05-29

Tatami

1 09:00

Pool

1/2

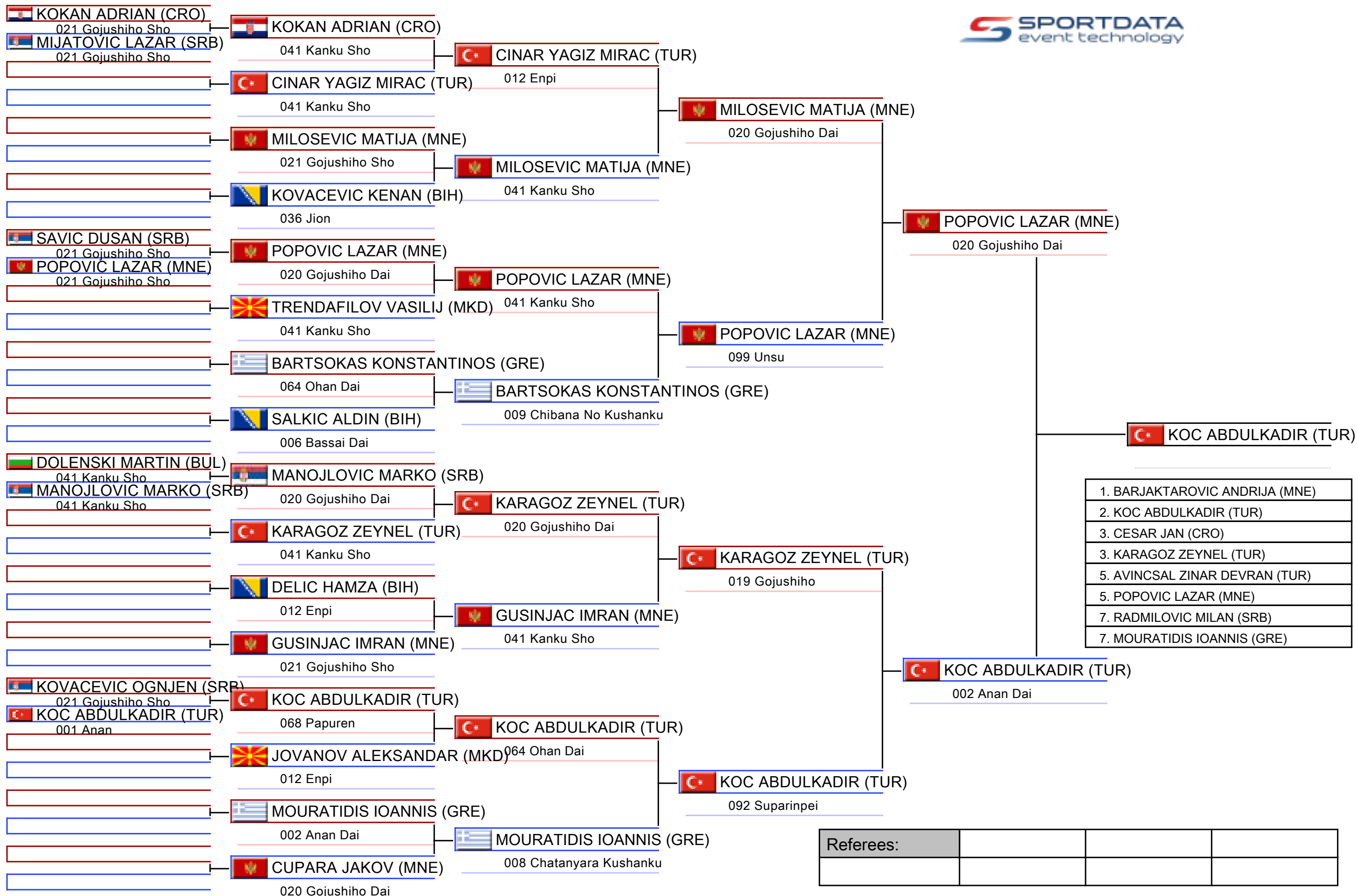

Referees:			

13 Yrs Kata Individual Male

30th Balkan Karate Championships for Children 2026 - Istanbul, Basaksehir Spor Hall, Kayabaşı, TINAZTEPE CADDESİ NO:6, 34494 Başakşehir, İstanbul, TUR2026-05-29

Tatami

1 10:35

Pool

2/2

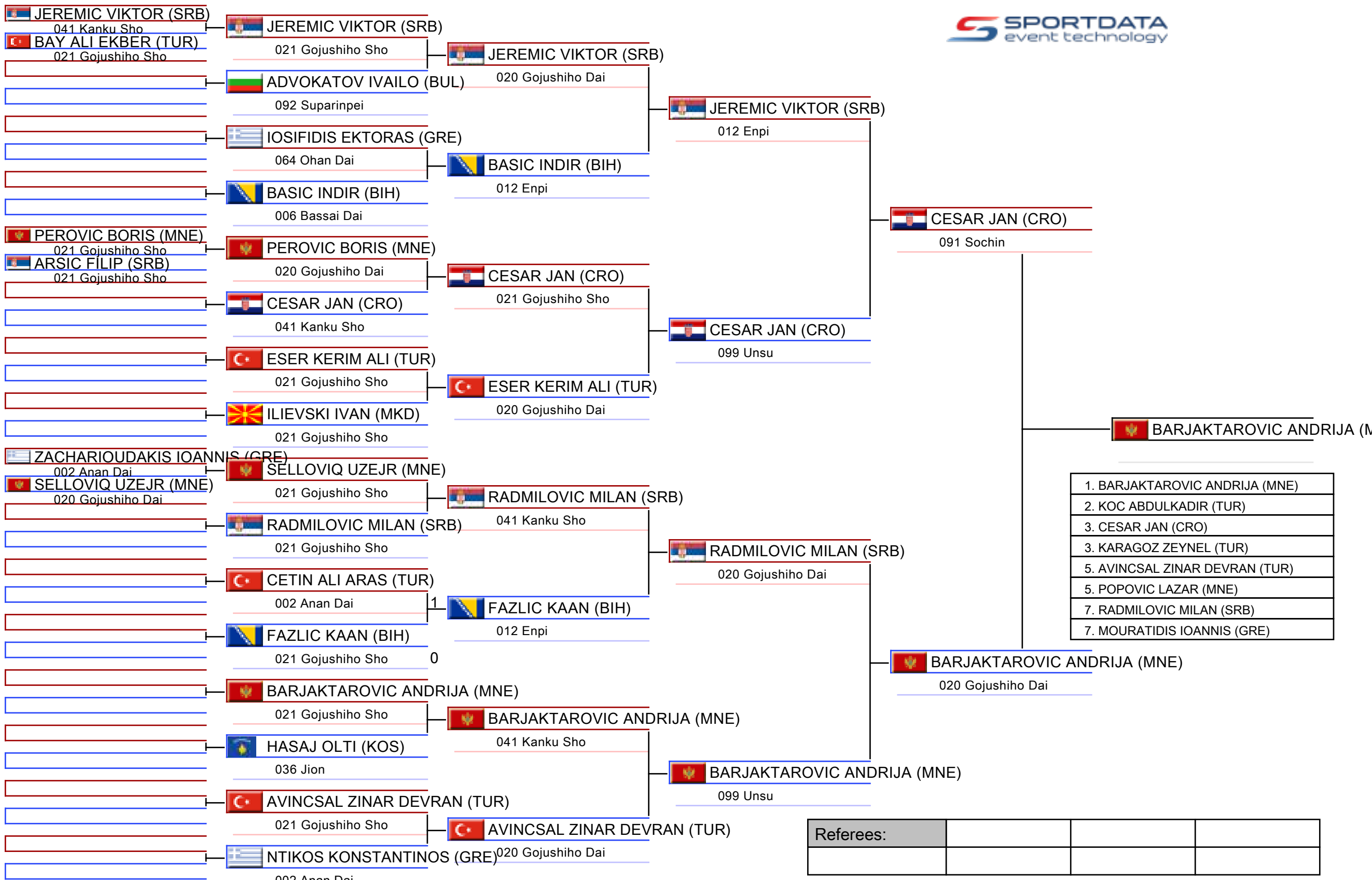

1. BARJAKTAROVIC ANDRIJA (MNE)
2. KOC ABDULKADIR (TUR)
3. CESAR JAN (CRO)
3. KARAGOZ ZEYNEL (TUR)
5. AVINCSAL ZINAR DEVRAN (TUR)
5. POPOVIC LAZAR (MNE)
7. RADMILOVIC MILAN (SRB)
7. MOURATIDIS IOANNIS (GRE)

Referees:			

Pool winner-13 Yrs Kata Individual Male

30th Balkan Karate Championships for Children 2026 - Istanbul, Basaksehir Spor Hall, Kayabaşı, TINAZTEPE CADDESİ NO:6, 34494 Başakşehir, İstanbul, TUR

Tatami

Pool
1/1



Final

 **KOC ABDULKADIR (TUR)**

092 Suparinpei

 **BARJAKTAROVIC ANDRIJA (MNE)**

 **BARJAKTAROVIC ANDRIJA (MNE)**

041 Kanku Sho

- | |
|--------------------------------|
| 1. BARJAKTAROVIC ANDRIJA (MNE) |
| 2. KOC ABDULKADIR (TUR) |
| 3. CESAR JAN (CRO) |
| 3. KARAGOZ ZEYNEL (TUR) |
| 5. AVINCSAL ZINAR DEVRAN (TUR) |
| 5. POPOVIC LAZAR (MNE) |
| 7. RADMILOVIC MILAN (SRB) |
| 7. MOURATIDIS IOANNIS (GRE) |

Referees:			

13 Yrs Kata Individual Male

30th Balkan Karate Championships for Children 2026 - Istanbul

2026-05-29

Tatami
1 12:05

Pool
1,2

(c)sportdata GmbH & Co KG 2000-2026 (2026-05-31 14:44) v 12.2.0 build 1 (2026-05-24 19:07 CET) License: Lazar Piper SRB (expire 2027-01-23)

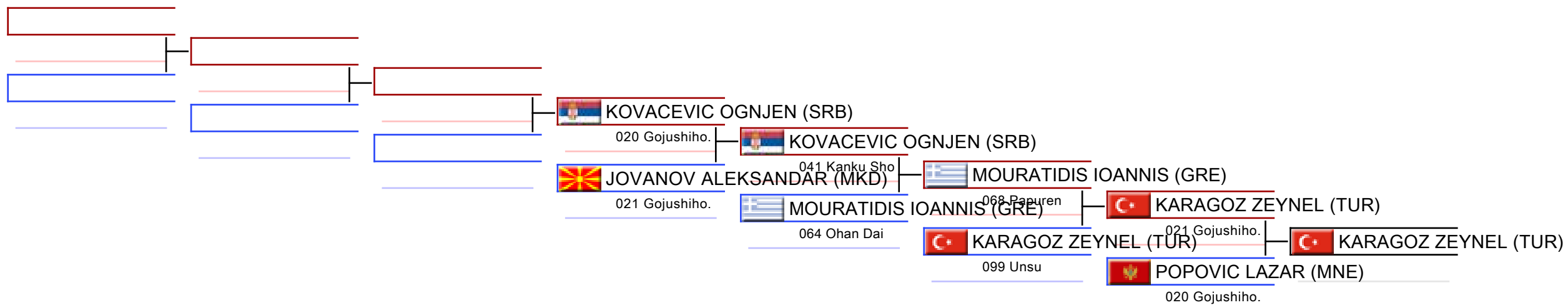

REPECHAGE: (1,2)

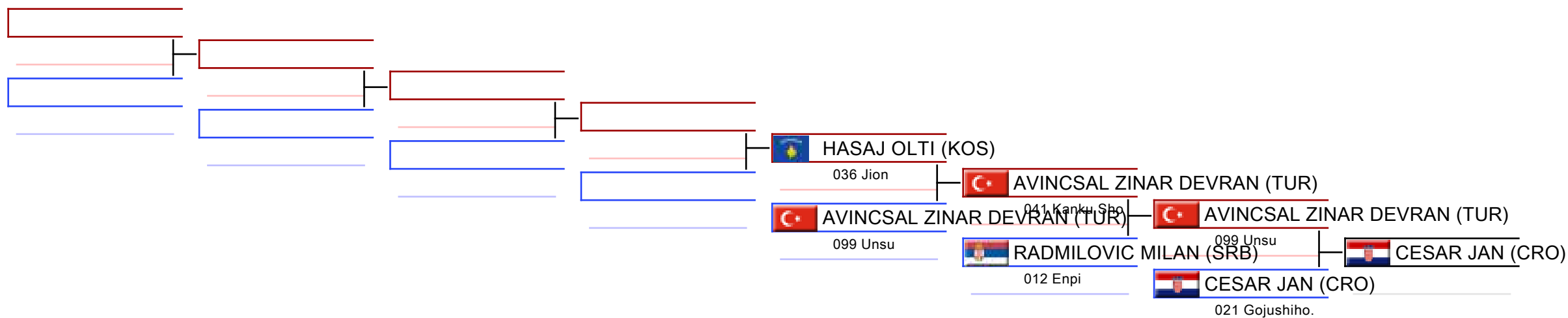

Referees:							
-----------	--	--	--	--	--	--	--

13 Yrs Kumite Female -39 kg

30th Balkan Karate Championships for Children 2026 - Istanbul, Basaksehir Spor Hall, Kayabaşı, TINAZTEPE CADDESİ NO:6, 34494 Başakşehir, İstanbul, TUR2026-05-29

Tatami

2 15:45

Pool

1/1

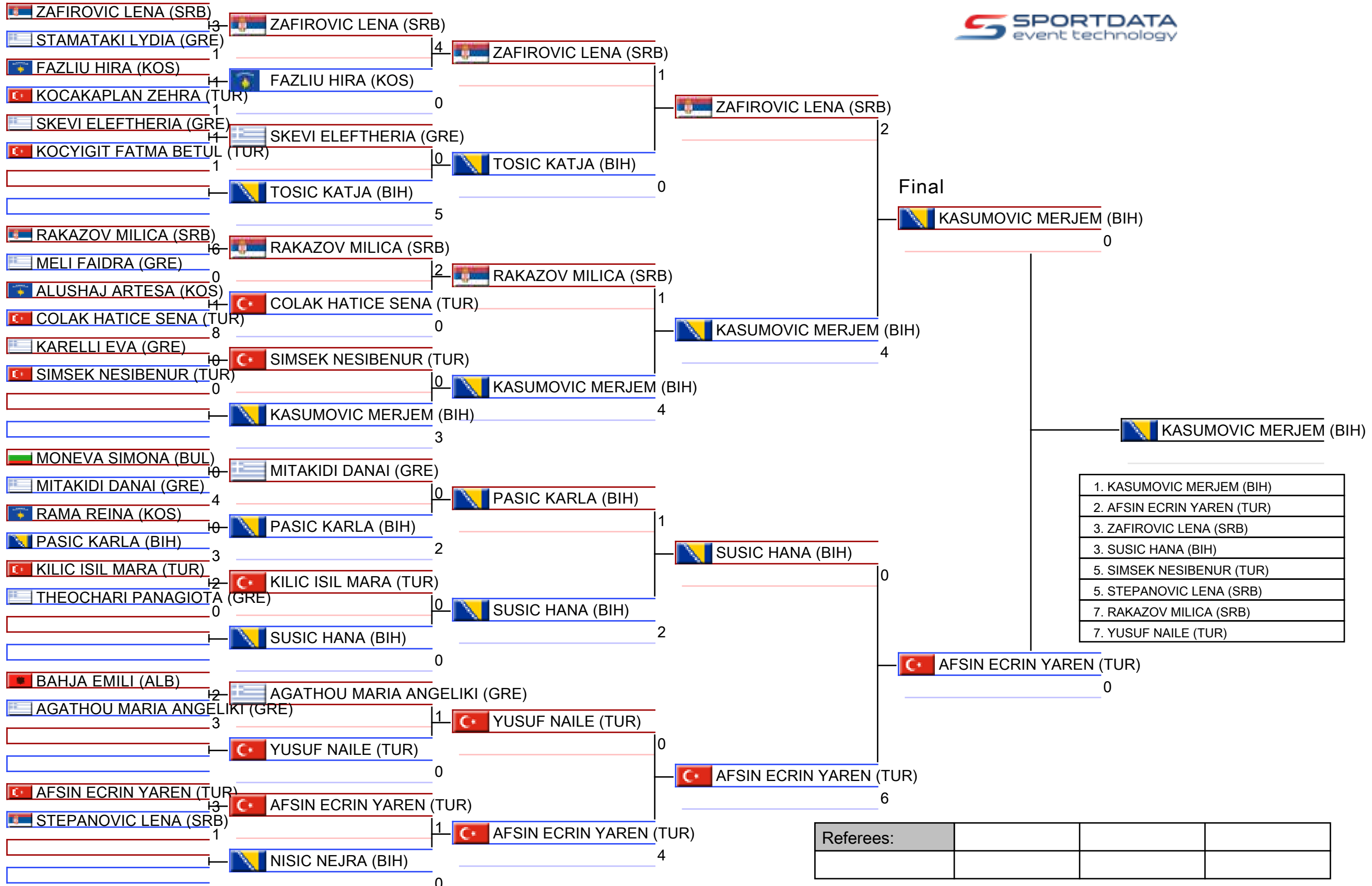

13 Yrs Kumite Female -39 kg

30th Balkan Karate Championships for Children 2026 - Istanbul

2026-05-29

Tatami
2 17:10

Pool
1

(c)sportdata GmbH & Co KG 2000-2026 (2026-05-31 14:44) v 12.2.0 build 1 (2026-05-24 19:07 CET) License: Lazar Piper SRB (expire 2027-01-23)

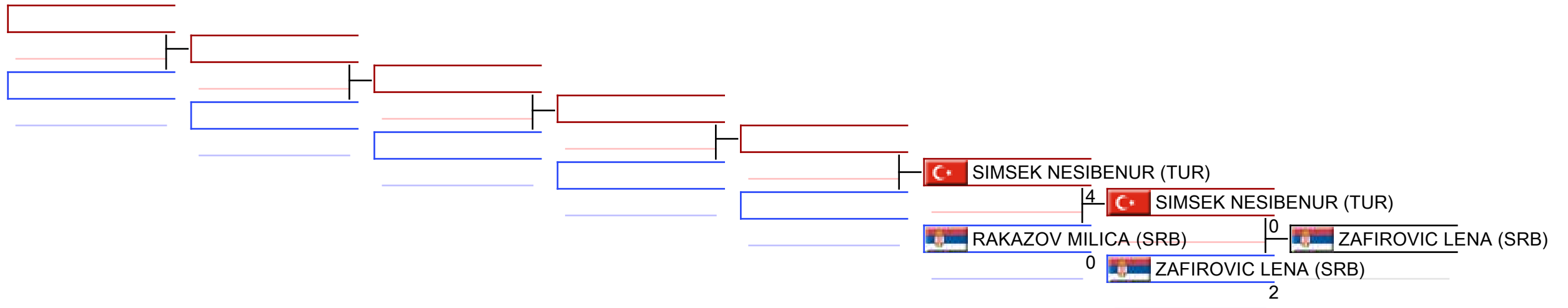

REPECHAGE: (1)

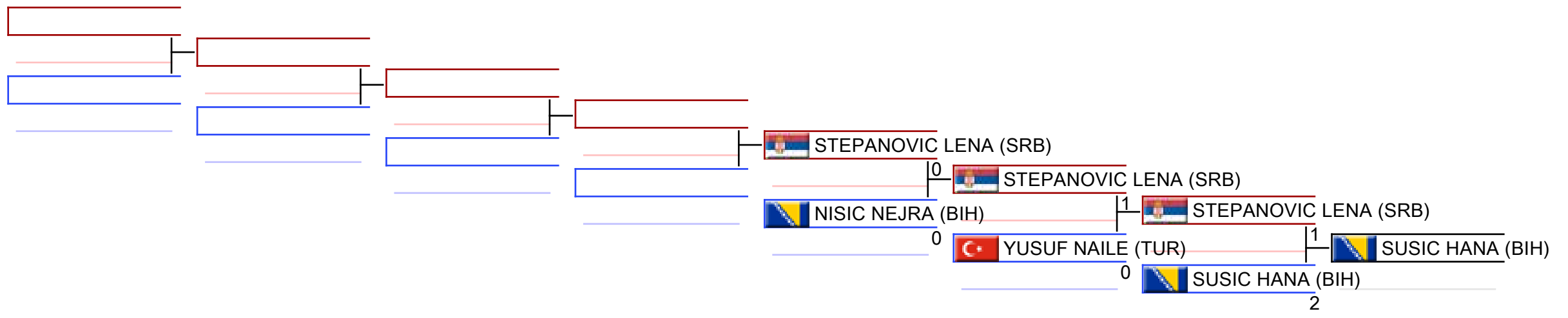

Referees:							
-----------	--	--	--	--	--	--	--

13 Yrs Kumite Female -44 kg

30th Balkan Karate Championships for Children 2026 - Istanbul, Basaksehir Spor Hall, Kayabaşı, TINAZTEPE CADDESİ NO:6, 34494 Başakşehir, İstanbul, TUR2026-05-31

Tatami

2 10:55

Pool

2/2

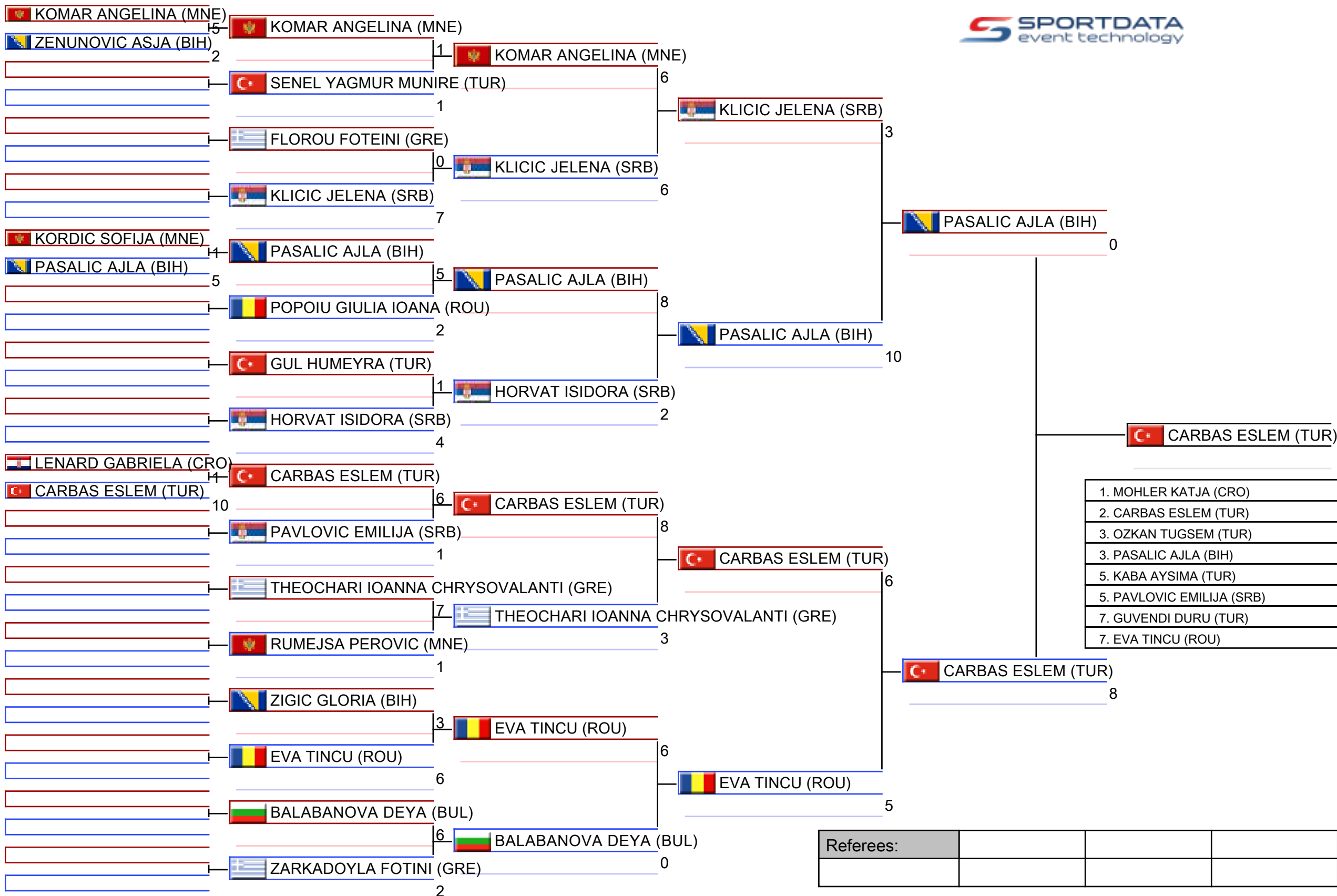

Referees:			

Pool winner-13 Yrs Kumite Female -44 kg

30th Balkan Karate Championships for Children 2026 - Istanbul, Basaksehir Spor Hall, Kayabaşı, TINAZTEPE CADDESİ NO:6, 34494 Başakşehir, İstanbul, TUR

Tatami

Pool

1/1

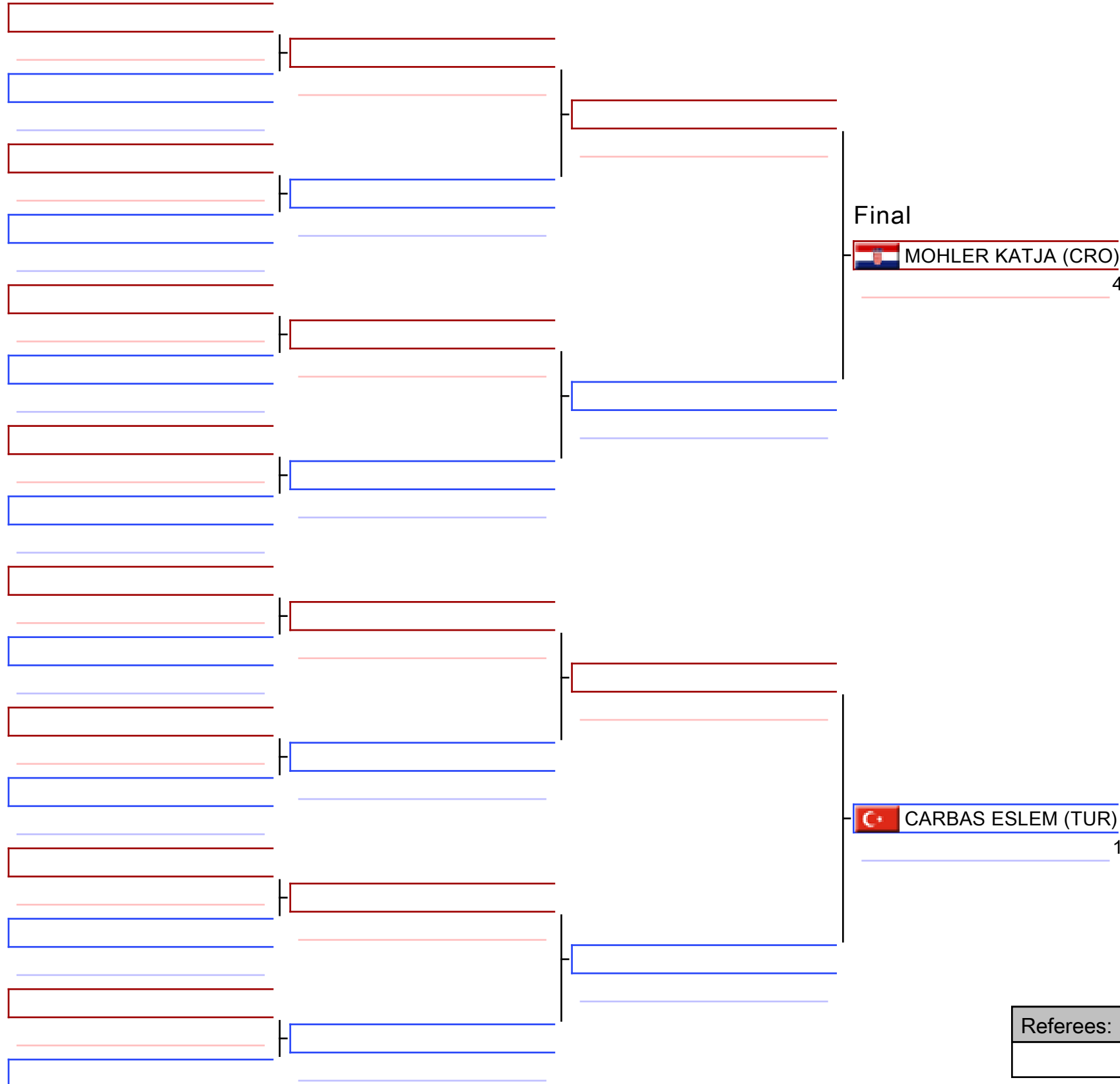

Final

MOHLER KATJA (CRO)

4

MOHLER KATJA (CRO)

CARBAS ESLEM (TUR)

1

1. MOHLER KATJA (CRO)
2. CARBAS ESLEM (TUR)
3. OZKAN TUGSEM (TUR)
3. PASALIC AJLA (BIH)
5. KABA AYSIMA (TUR)
5. PAVLOVIC EMILIJA (SRB)
7. GUVENDI DURU (TUR)
7. EVA TINCU (ROU)

Referees:			

13 Yrs Kumite Female -44 kg

30th Balkan Karate Championships for Children 2026 - Istanbul

2026-05-31

Tatami
2 12:00

Pool
1,2

(c)sportdata GmbH & Co KG 2000-2026 (2026-05-31 14:44) v 12.2.0 build 1 (2026-05-24 19:07 CET) License: Lazar Piper SRB (expire 2027-01-23)

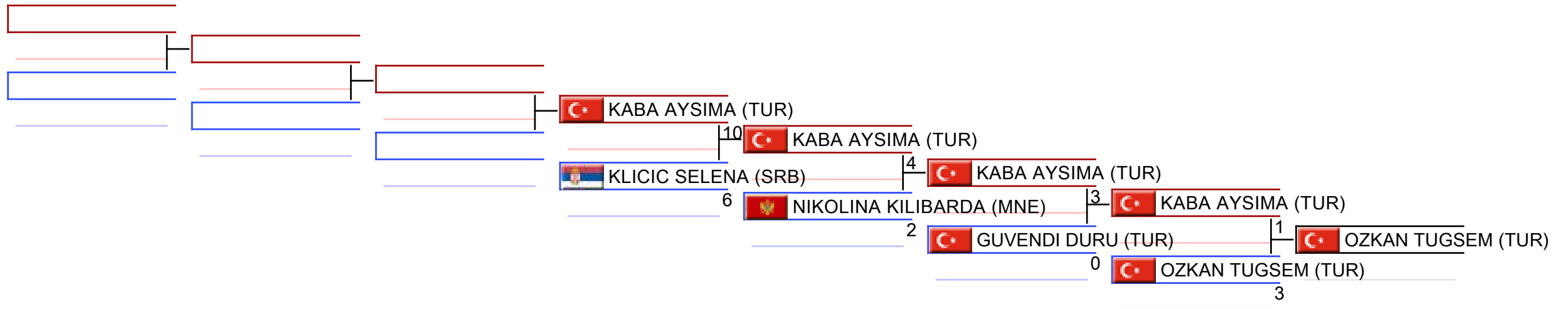

REPECHAGE: (1,2)

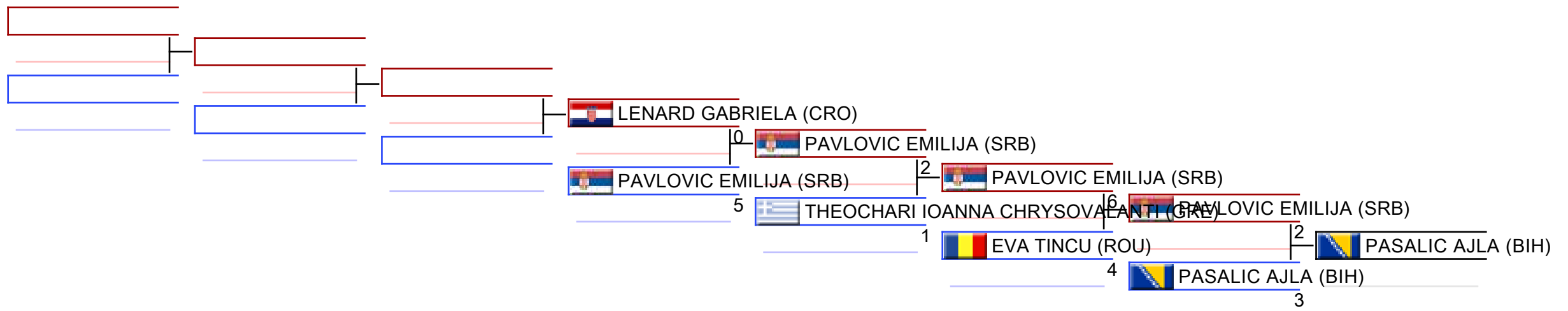

Referees:							
-----------	--	--	--	--	--	--	--

13 Yrs Kumite Female -49 kg

30th Balkan Karate Championships for Children 2026 - Istanbul, Basaksehir Spor Hall, Kayabaşı, TINAZTEPE CADDESİ NO:6, 34494 Başakşehir, İstanbul, TUR2026-05-29

Tatami

6 14:30

Pool

1/2

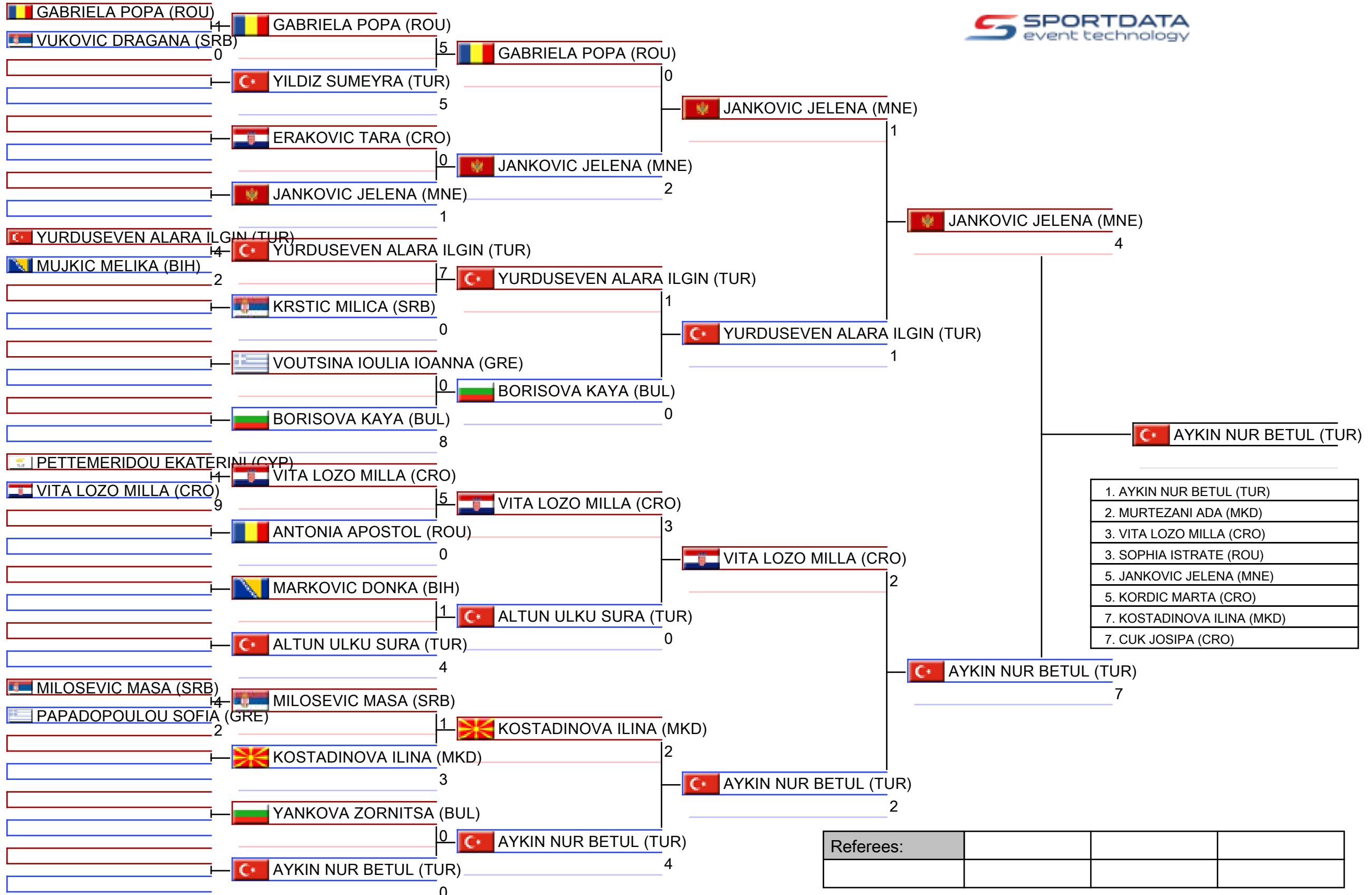

1. AYKIN NUR BETUL (TUR)
2. MURTEZANI ADA (MKD)
3. VITA LOZO MILLA (CRO)
3. SOPHIA ISTRATE (ROU)
5. JANKOVIC JELENA (MNE)
5. KORDIC MARTA (CRO)
7. KOSTADINOVA ILINA (MKD)
7. CUK JOSIPA (CRO)

Referees:			

13 Yrs Kumite Female -49 kg

30th Balkan Karate Championships for Children 2026 - Istanbul, Basaksehir Spor Hall, Kayabaşı, TINAZTEPE CADDESİ NO:6, 34494 Başakşehir, İstanbul, TUR2026-05-29

Tatami

6 16:20

Pool

2/2

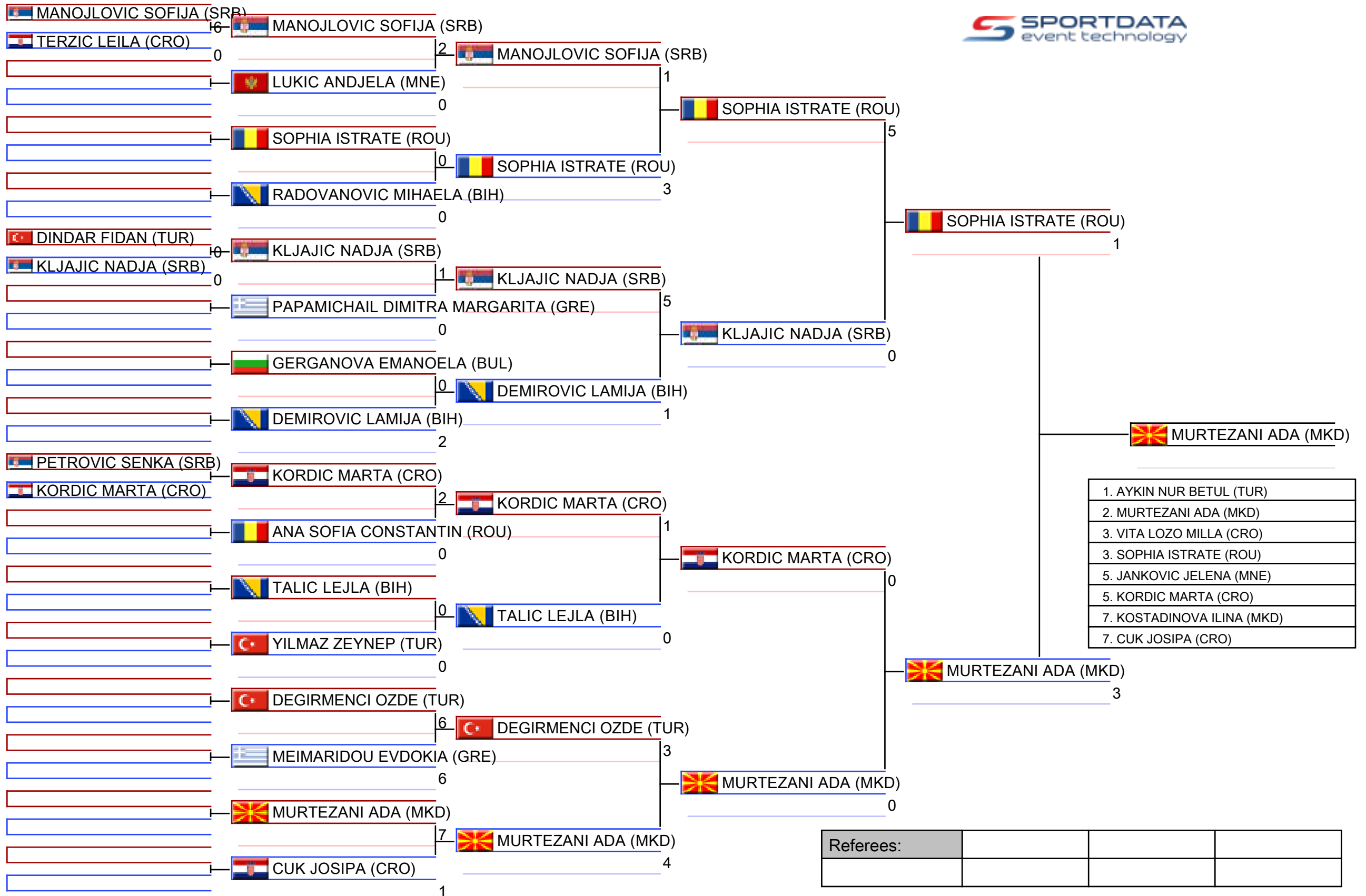

Referees:			

Pool winner-13 Yrs Kumite Female -49 kg

30th Balkan Karate Championships for Children 2026 - Istanbul, Basaksehir Spor Hall, Kayabaşı, TINAZTEPE CADDESİ NO:6, 34494 Başakşehir, İstanbul, TUR

Tatami

Pool

1/1

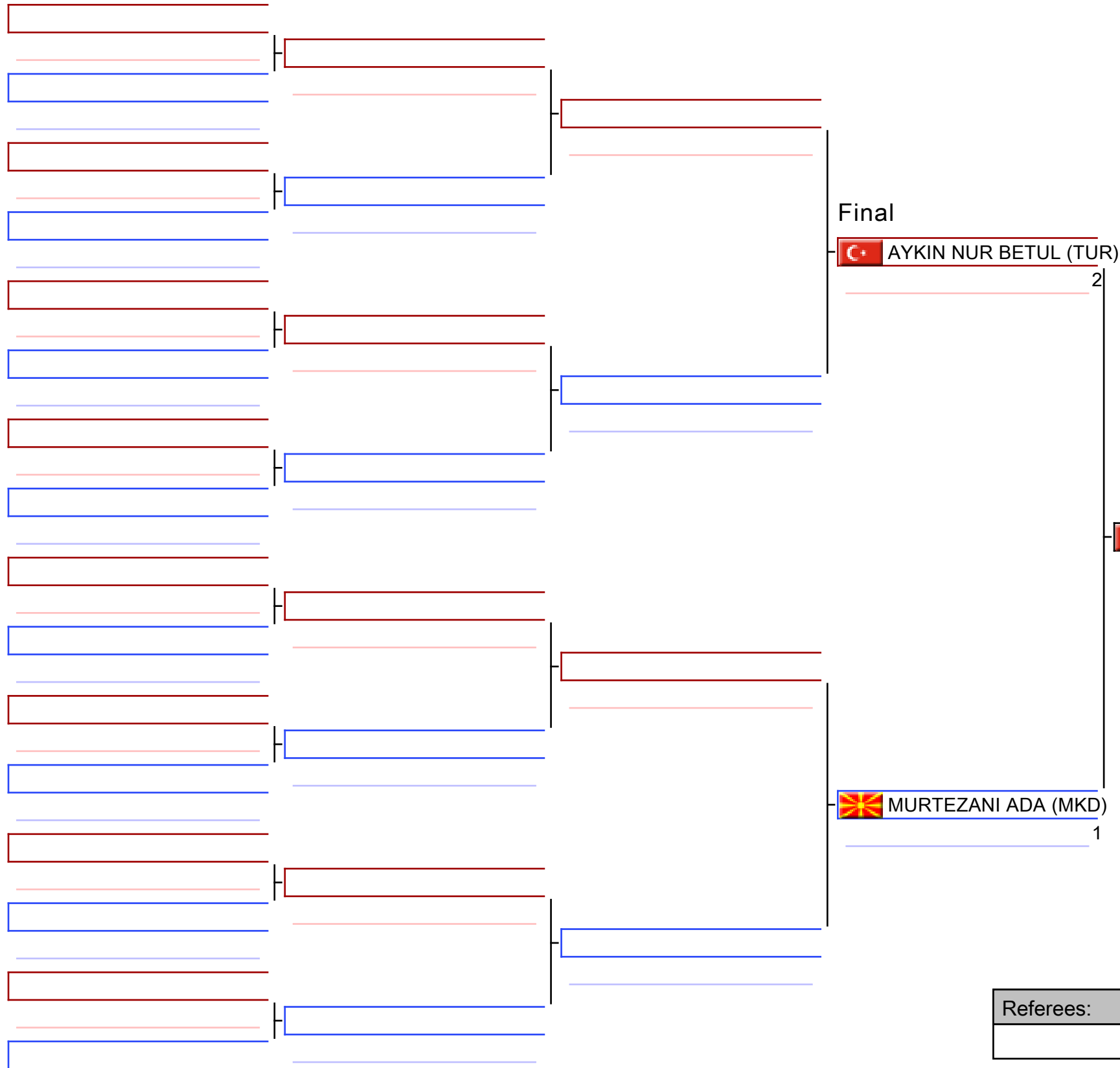

AYKIN NUR BETUL (TUR)

1. AYKIN NUR BETUL (TUR)
2. MURTEZANI ADA (MKD)
3. VITA LOZO MILLA (CRO)
3. SOPHIA ISTRATE (ROU)
5. JANKOVIC JELENA (MNE)
5. KORDIC MARTA (CRO)
7. KOSTADINOVA ILINA (MKD)
7. CUK JOSIPA (CRO)

Referees:			

13 Yrs Kumite Female -49 kg

30th Balkan Karate Championships for Children 2026 - Istanbul

2026-05-29

Tatami
6 17:25

Pool
1

(c)sportdata GmbH & Co KG 2000-2026 (2026-05-31 14:44) v 12.2.0 build 1 (2026-05-24 19:07 CET) License: Lazar Piper SRB (expire 2027-01-23)

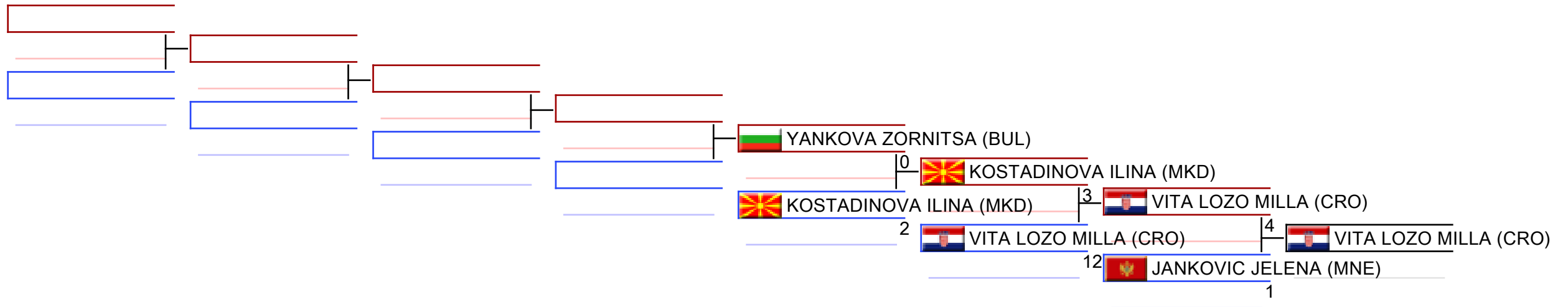

REPECHAGE: (1)

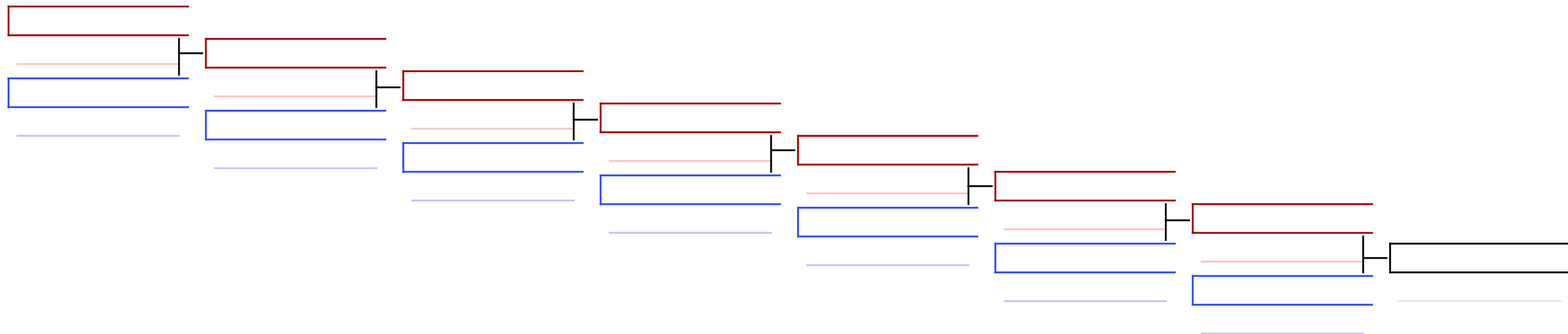

Referees:							
-----------	--	--	--	--	--	--	--

13 Yrs Kumite Female -49 kg

30th Balkan Karate Championships for Children 2026 - Istanbul

2026-05-29

Tatami
6 17:40

Pool
2

(c)sportdata GmbH & Co KG 2000-2026 (2026-05-31 14:44) v 12.2.0 build 1 (2026-05-24 19:07 CET) License: Lazar Piper SRB (expire 2027-01-23)

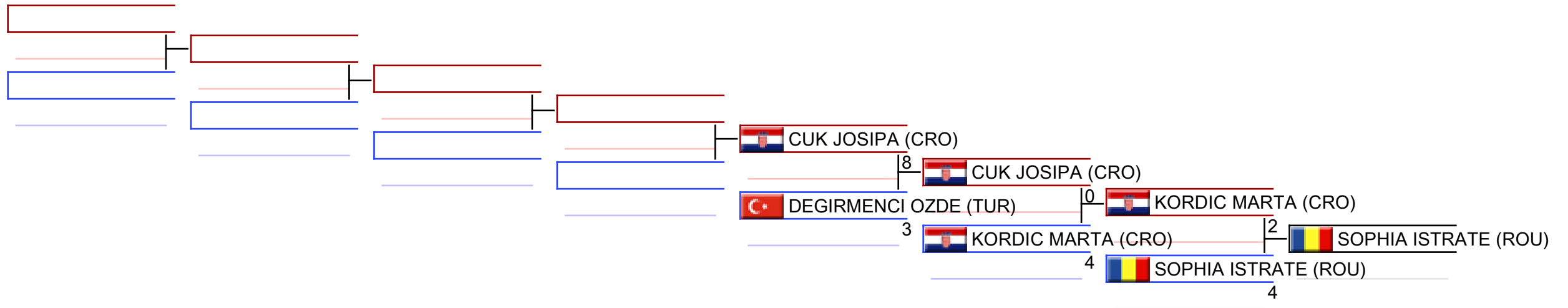

REPECHAGE: (2)

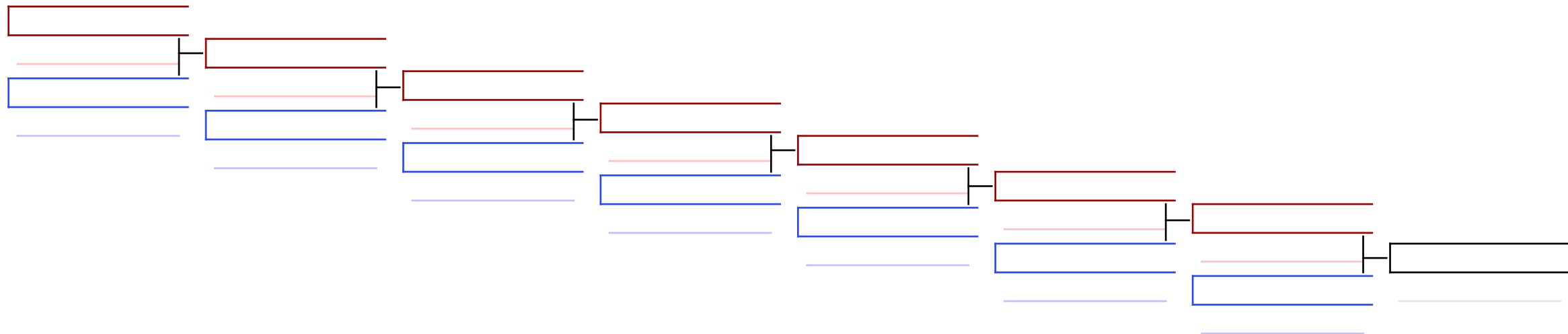

Referees:							
-----------	--	--	--	--	--	--	--

13 Yrs Kumite Female -54 kg

30th Balkan Karate Championships for Children 2026 - Istanbul, Basaksehir Spor Hall, Kayabaşı, TINAZTEPE CADDESİ NO:6, 34494 Başakşehir, İstanbul, TUR2026-05-31

Tatami

6 09:40

Pool

1/2

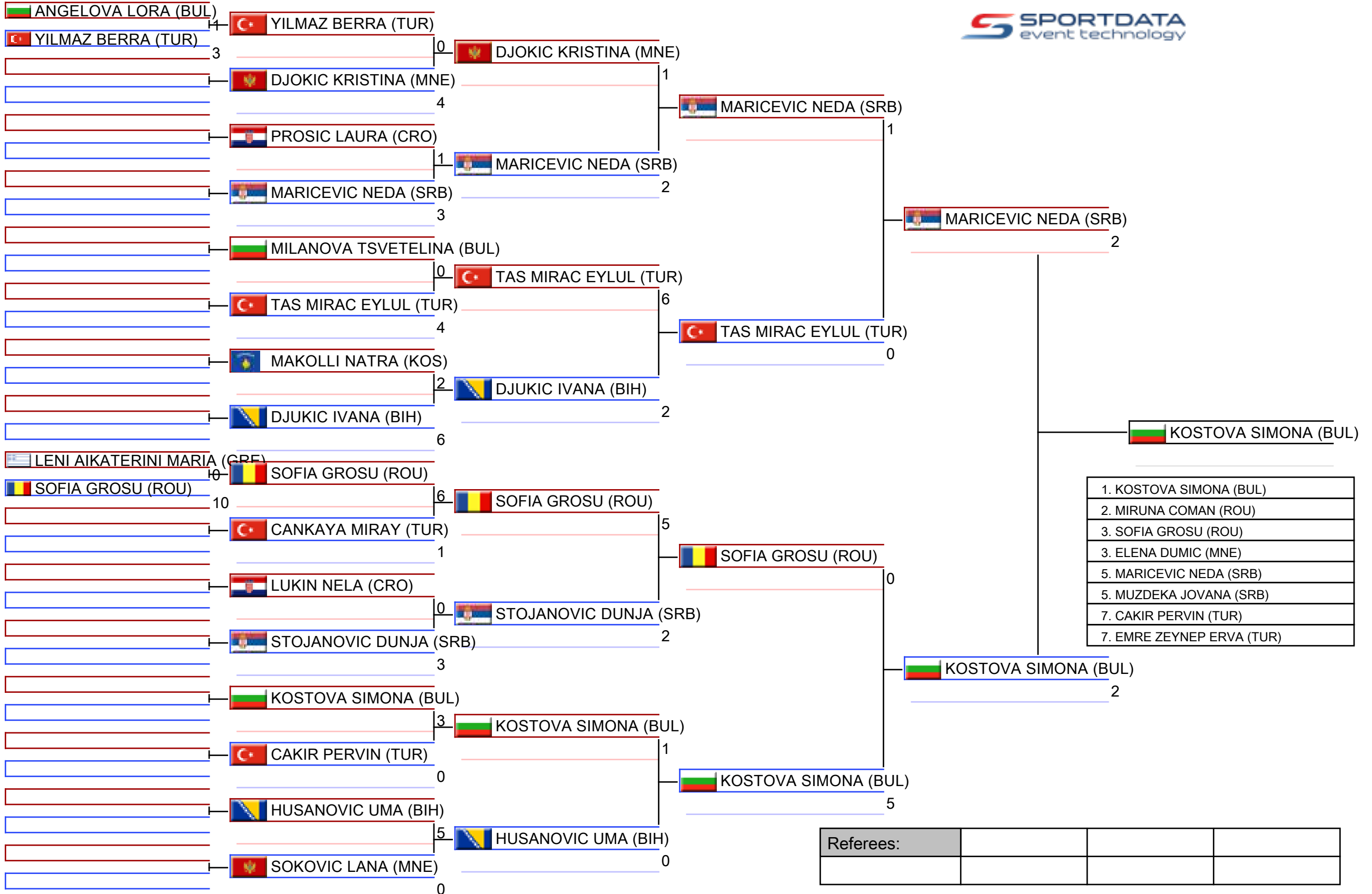

1. KOSTOVA SIMONA (BUL)
2. MIRUNA COMAN (ROU)
3. SOFIA GROSU (ROU)
3. ELENA DUMIC (MNE)
5. MARICEVIC NEDA (SRB)
5. MUZDEKA JOVANA (SRB)
7. CAKIR PERVIN (TUR)
7. EMRE ZEYNEP ERVA (TUR)

Referees:			

13 Yrs Kumite Female -54 kg

30th Balkan Karate Championships for Children 2026 - Istanbul, Basaksehir Spor Hall, Kayabaşı, TINAZTEPE CADDESİ NO:6, 34494 Başakşehir, İstanbul, TUR2026-05-31

Tatami

6 10:40

Pool

2/2

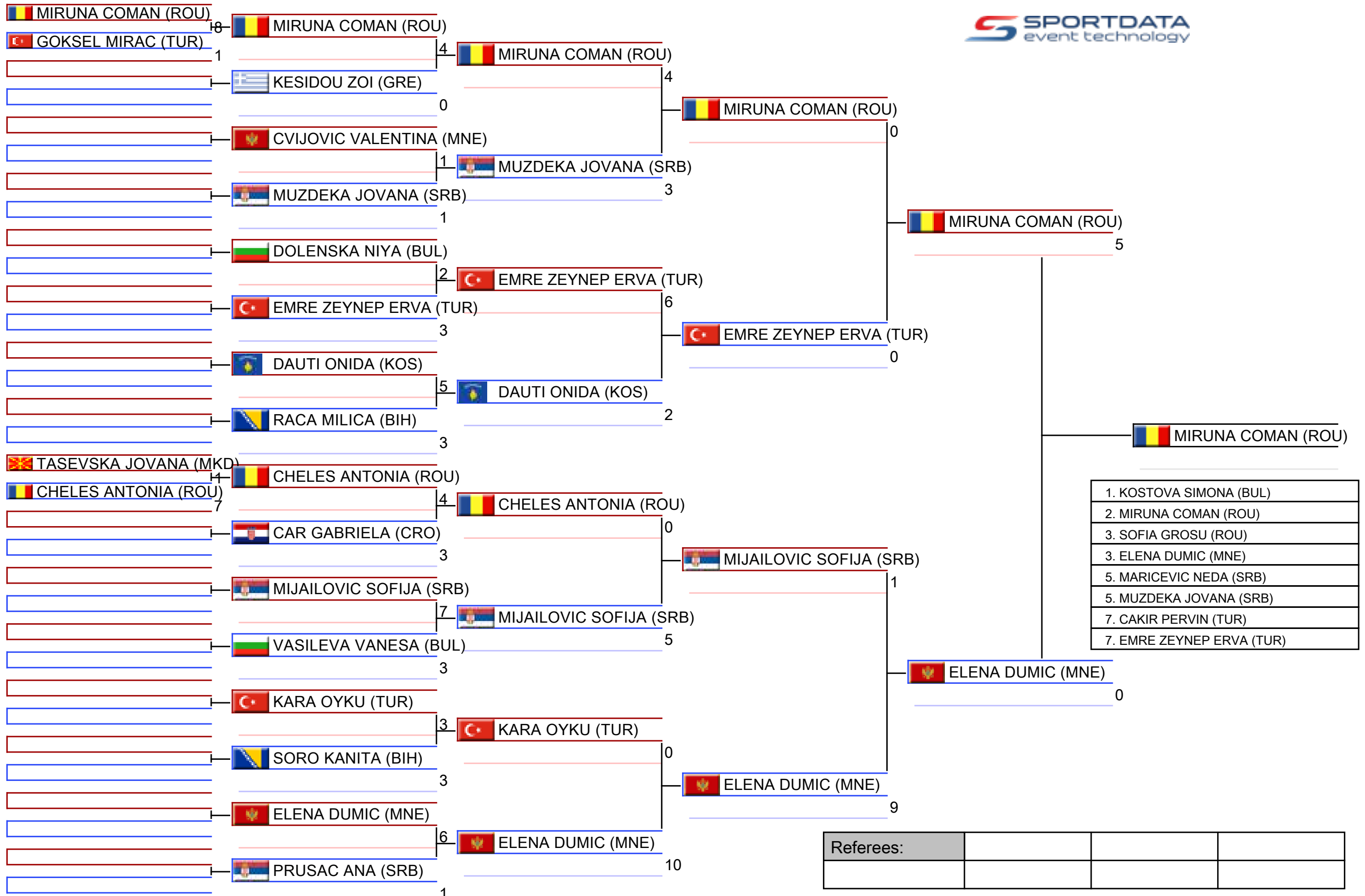

Referees:			

Pool winner-13 Yrs Kumite Female -54 kg

30th Balkan Karate Championships for Children 2026 - Istanbul, Basaksehir Spor Hall, Kayabaşı, TINAZTEPE CADDESİ NO:6, 34494 Başakşehir, İstanbul, TUR

Tatami

Pool

1/1

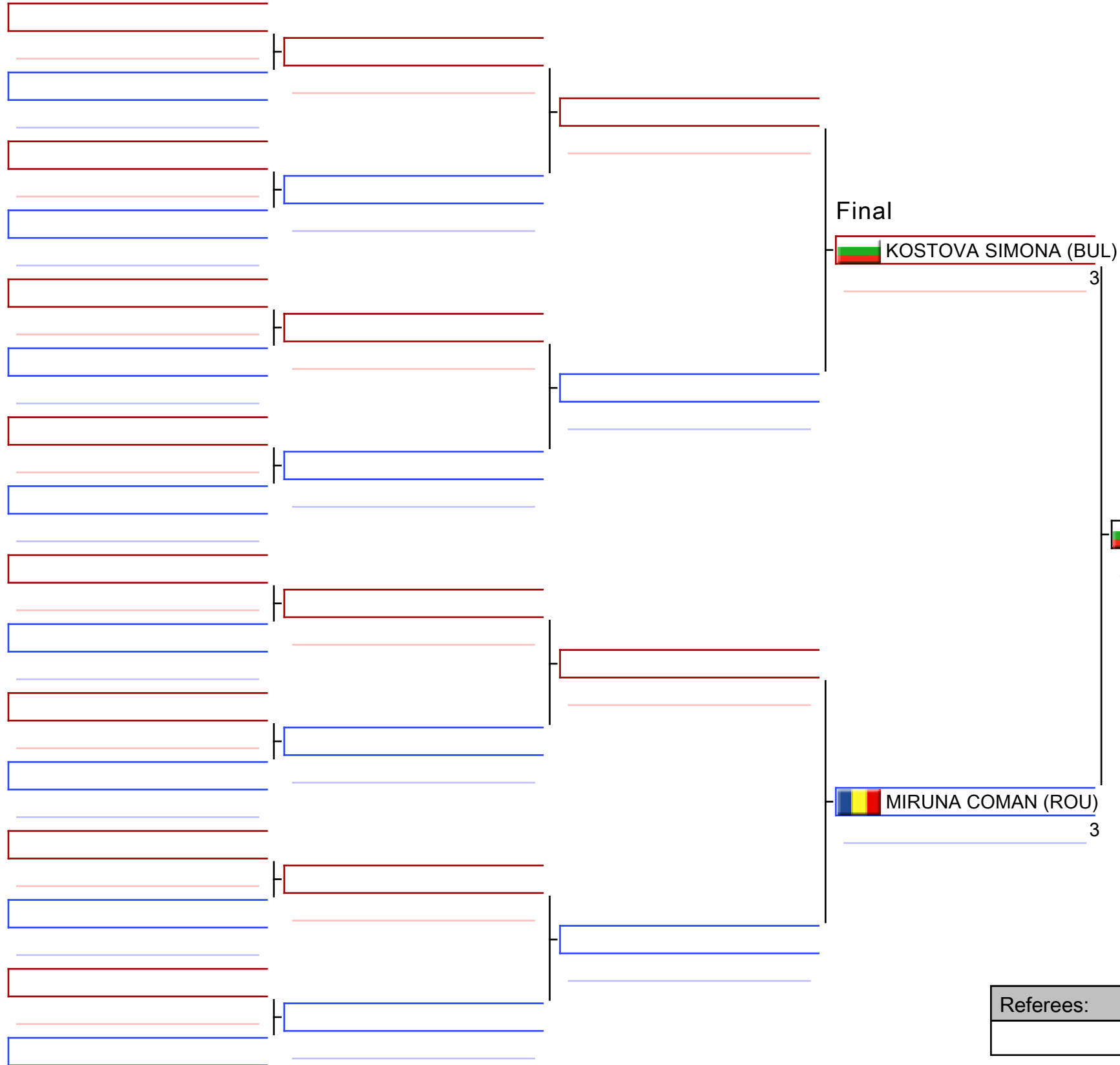

KOSTOVA SIMONA (BUL)

Final

KOSTOVA SIMONA (BUL)

3

MIRUNA COMAN (ROU)

3

1. KOSTOVA SIMONA (BUL)
2. MIRUNA COMAN (ROU)
3. SOFIA GROSU (ROU)
3. ELENA DUMIC (MNE)
5. MARICEVIC NEDA (SRB)
5. MUZDEKA JOVANA (SRB)
7. CAKIR PERVIN (TUR)
7. EMRE ZEYNEP ERVA (TUR)

Referees:			

13 Yrs Kumite Female -54 kg

30th Balkan Karate Championships for Children 2026 - Istanbul

2026-05-31

Tatami
6 11:40

Pool
1

(c)sportdata GmbH & Co KG 2000-2026 (2026-05-31 14:44) v 12.2.0 build 1 (2026-05-24 19:07 CET) License: Lazar Piper SRB (expire 2027-01-23)

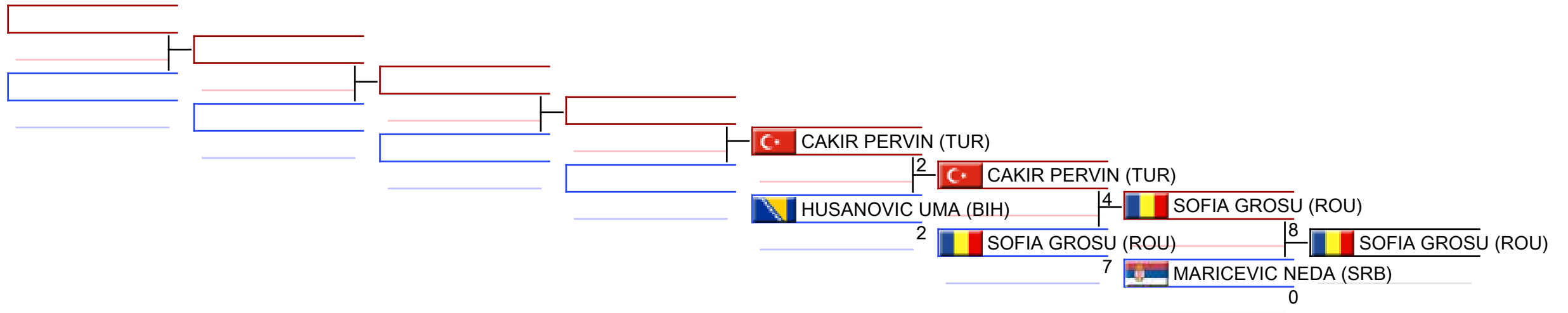

REPECHAGE: (1)

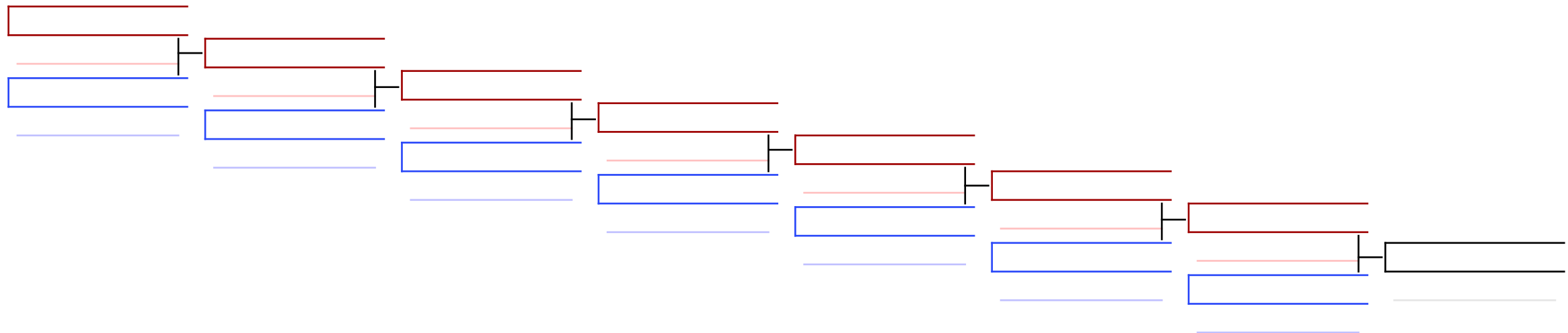

Referees:							
-----------	--	--	--	--	--	--	--

13 Yrs Kumite Female -54 kg

30th Balkan Karate Championships for Children 2026 - Istanbul

2026-05-31

Tatami
6 11:40

Pool
1,2

(c)sportdata GmbH & Co KG 2000-2026 (2026-05-31 14:44) v 12.2.0 build 1 (2026-05-24 19:07 CET) License: Lazar Piper SRB (expire 2027-01-23)



REPECHAGE: (1,2)

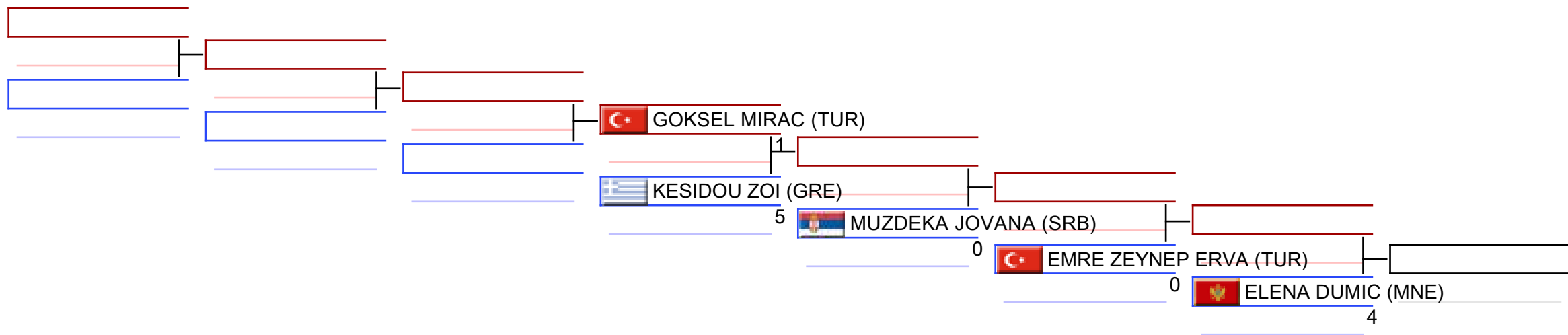

Referees:							
-----------	--	--	--	--	--	--	--

13 Yrs Kumite Female -54 kg

30th Balkan Karate Championships for Children 2026 - Istanbul

2026-05-31

Tatami
6 11:55

Pool
2

(c)sportdata GmbH & Co KG 2000-2026 (2026-05-31 14:44) v 12.2.0 build 1 (2026-05-24 19:07 CET) License: Lazar Piper SRB (expire 2027-01-23)

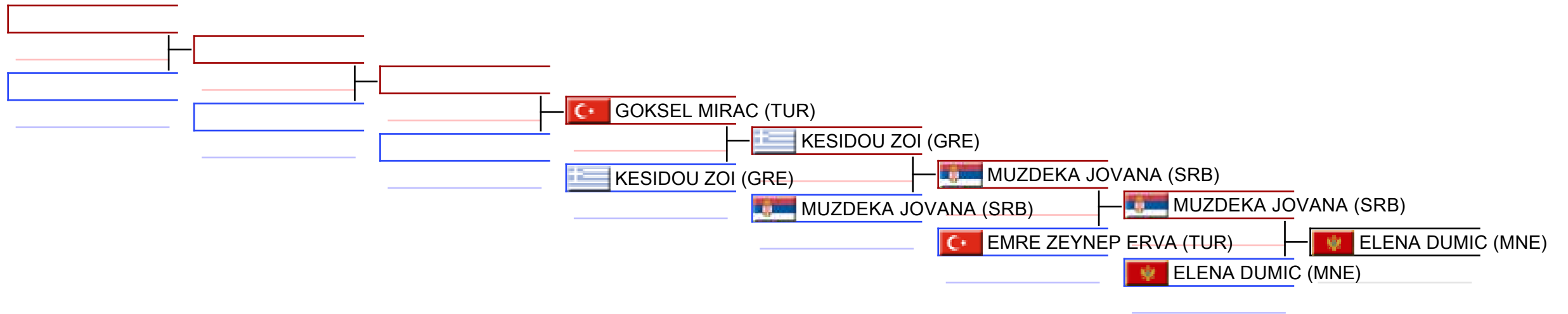

REPECHAGE: (2)

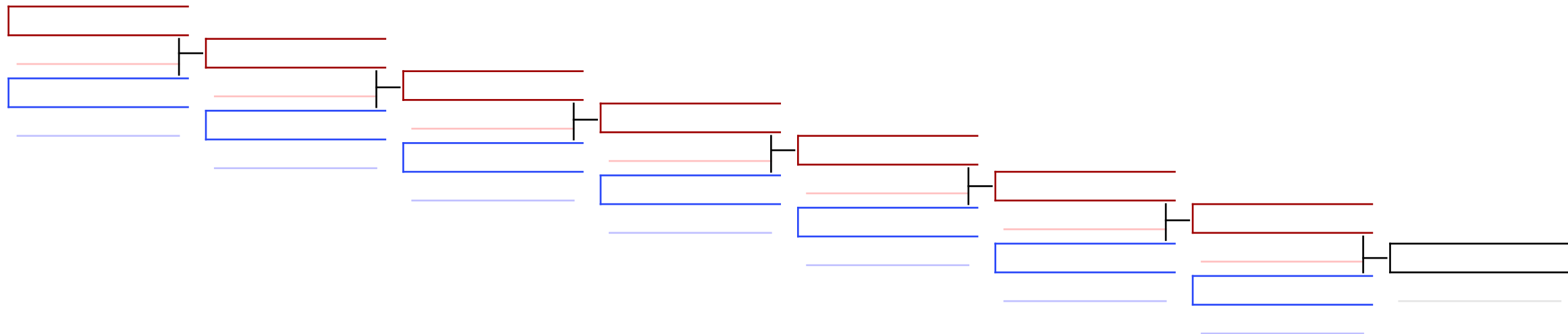

Referees:							
-----------	--	--	--	--	--	--	--

13 Yrs Kumite Female 54+ kg

30th Balkan Karate Championships for Children 2026 - Istanbul, Basaksehir Spor Hall, Kayabaşı, TINAZTEPE CADDESİ NO:6, 34494 Başakşehir, İstanbul, TUR2026-05-29

Tatami

1 14:30

Pool

1/2

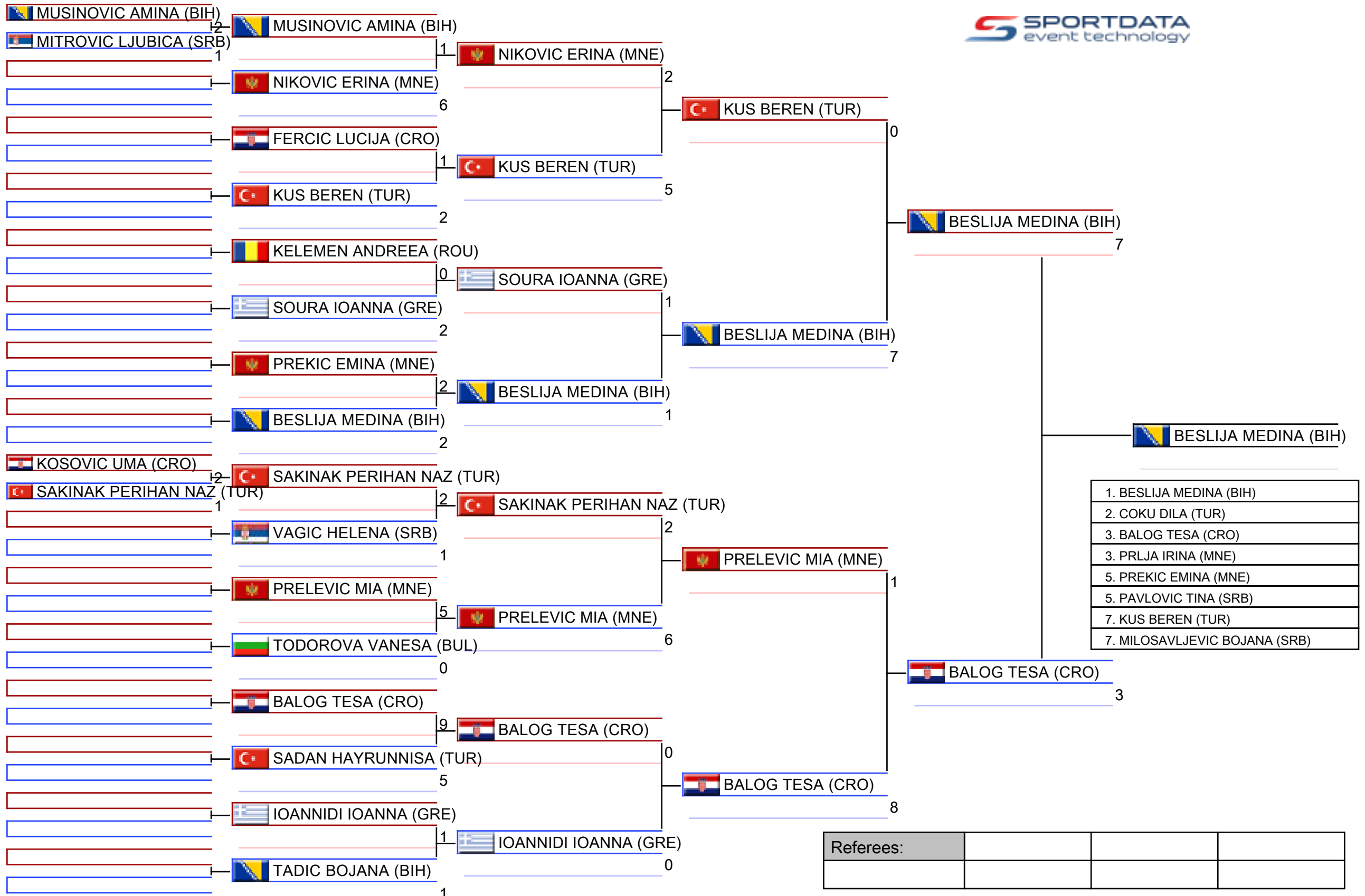

Referees:			

13 Yrs Kumite Female 54+ kg

30th Balkan Karate Championships for Children 2026 - Istanbul, Basaksehir Spor Hall, Kayabaşı, TINAZTEPE CADDESİ NO:6, 34494 Başakşehir, İstanbul, TUR2026-05-29

Tatami
1 16:15

Pool
2/2

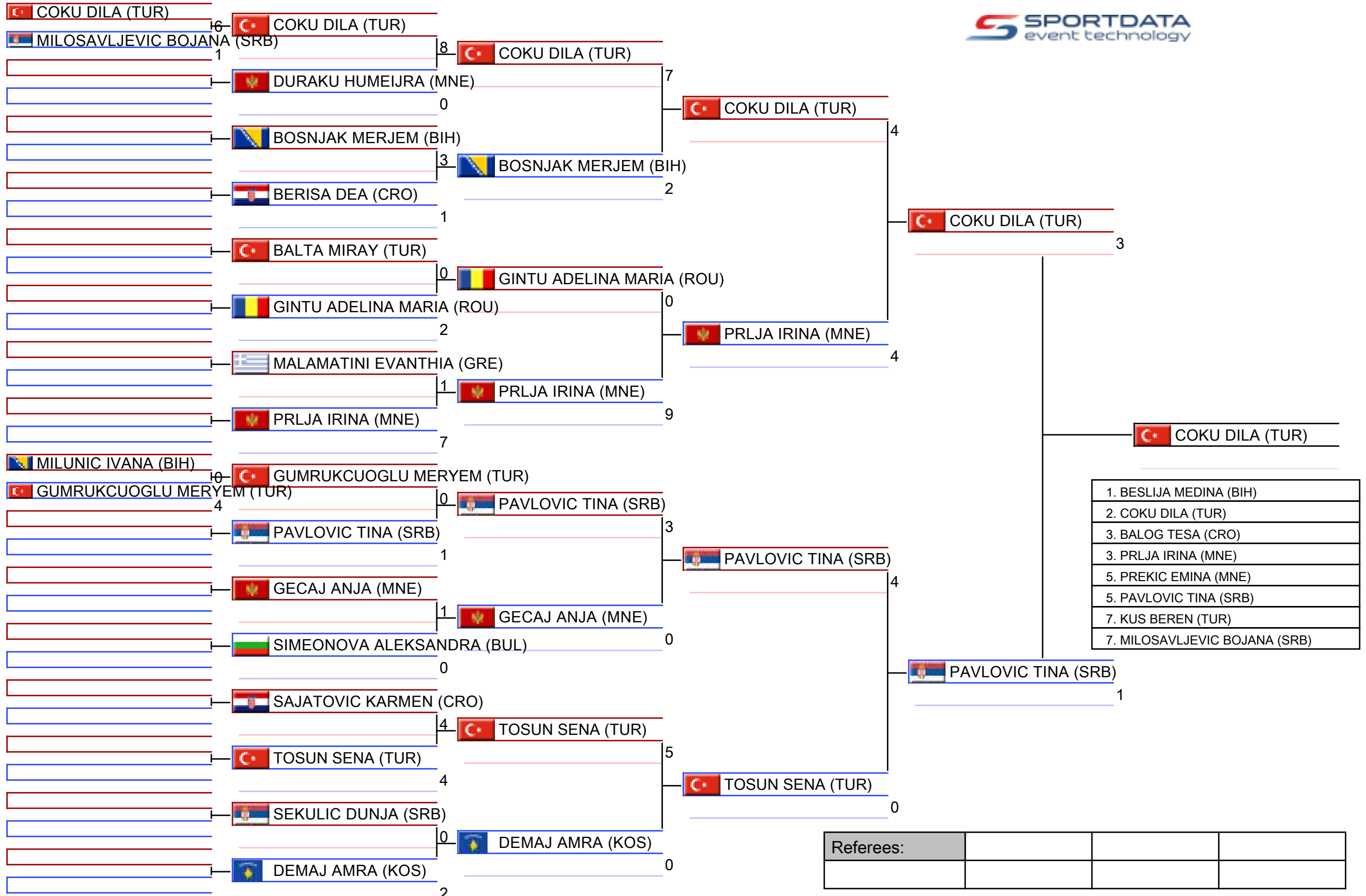

Pool winner-13 Yrs Kumite Female 54+ kg

30th Balkan Karate Championships for Children 2026 - Istanbul, Basaksehir Spor Hall, Kayabaşı, TINAZTEPE CADDESİ NO:6, 34494 Başakşehir, İstanbul, TUR

Tatami

Pool

1/1

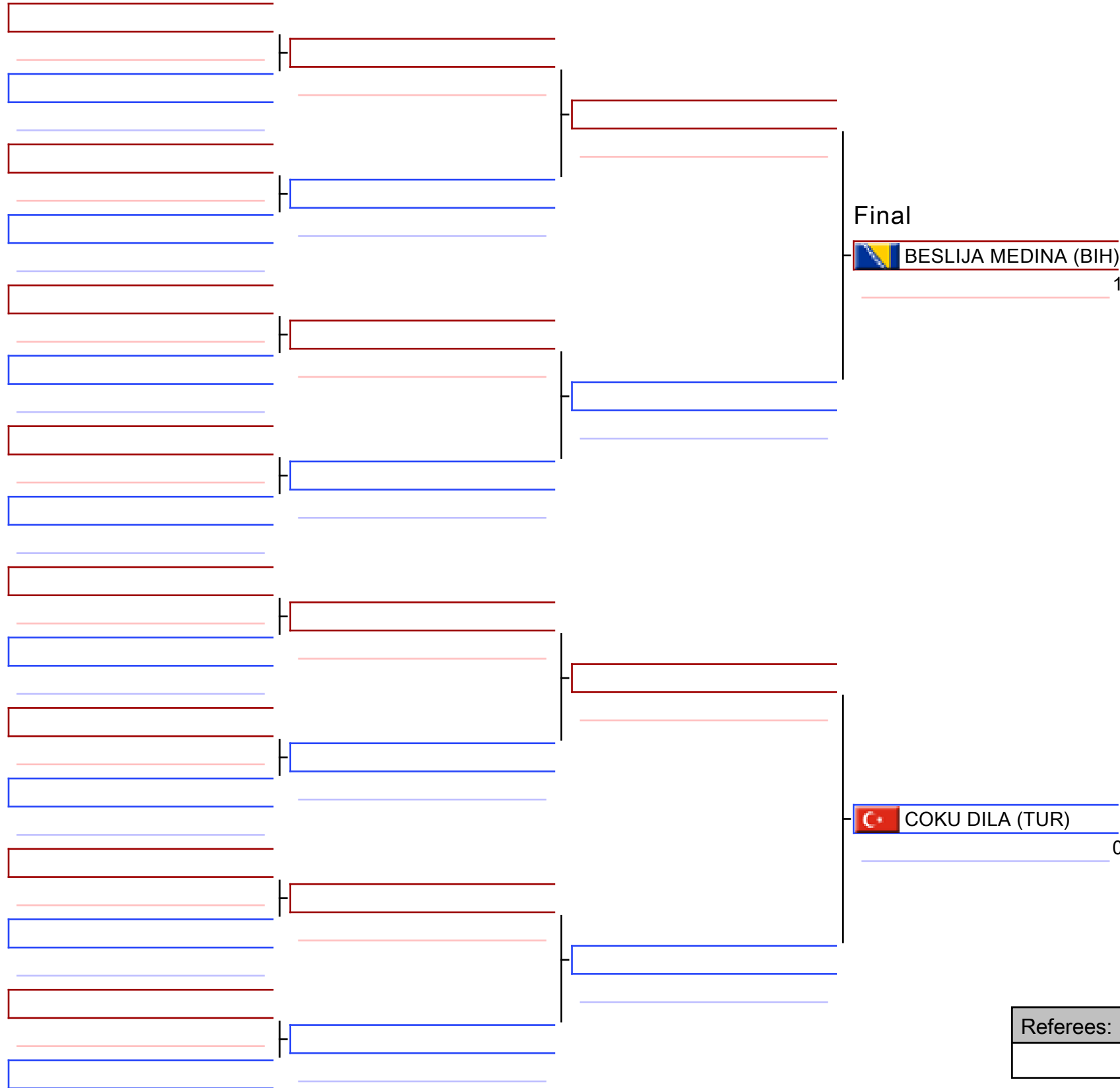

BESLIJA MEDINA (BIH)

1. BESLIJA MEDINA (BIH)
2. COKU DILA (TUR)
3. BALOG TESA (CRO)
3. PRLJA IRINA (MNE)
5. PREKIC EMINA (MNE)
5. PAVLOVIC TINA (SRB)
7. KUS BEREN (TUR)
7. MILOSAVLJEVIC BOJANA (SRB)

Referees:			

13 Yrs Kumite Female 54+ kg

30th Balkan Karate Championships for Children 2026 - Istanbul

2026-05-29

Tatami
1 17:15

Pool
1

(c)sportdata GmbH & Co KG 2000-2026 (2026-05-31 14:44) v 12.2.0 build 1 (2026-05-24 19:07 CET) License: Lazar Piper SRB (expire 2027-01-23)

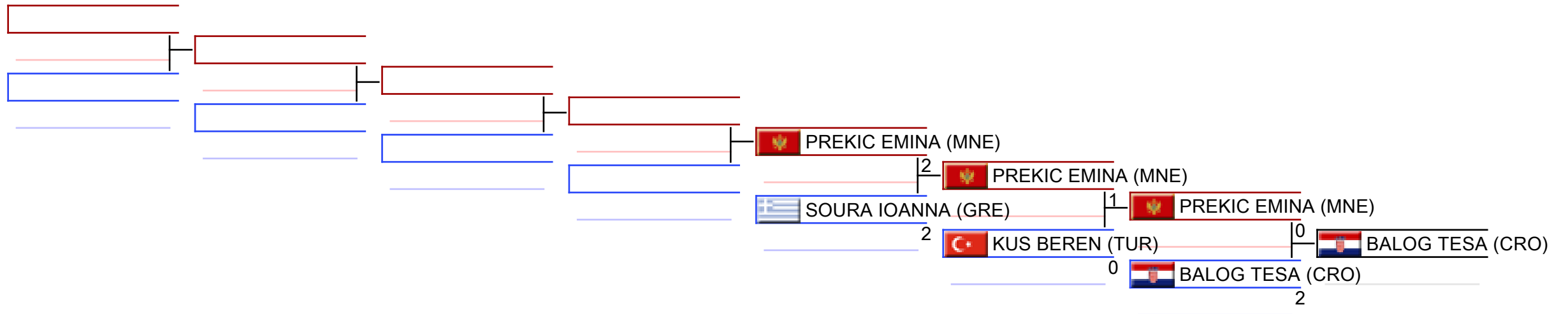

REPECHAGE: (1)

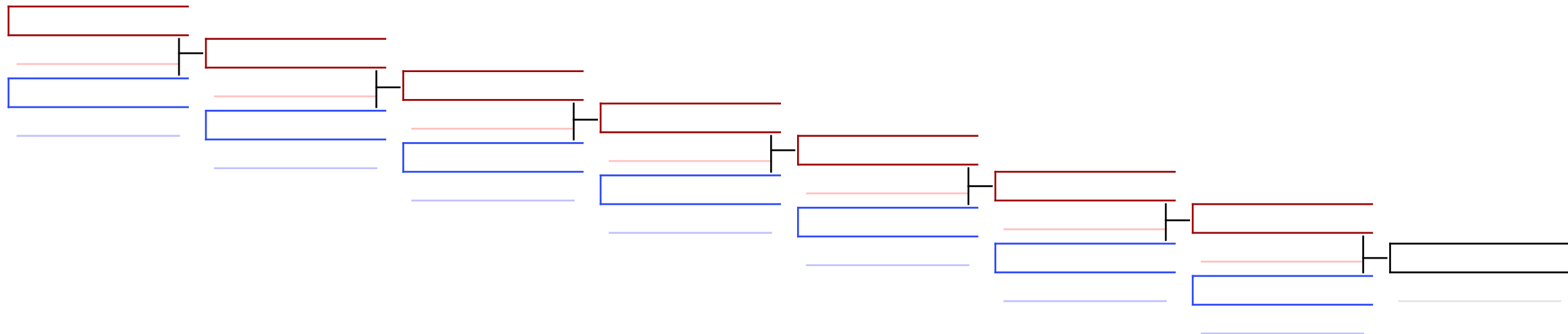

Referees:							
-----------	--	--	--	--	--	--	--

13 Yrs Kumite Female 54+ kg

30th Balkan Karate Championships for Children 2026 - Istanbul

2026-05-29

Tatami
1 17:30

Pool
2

(c)sportdata GmbH & Co KG 2000-2026 (2026-05-31 14:44) v 12.2.0 build 1 (2026-05-24 19:07 CET) License: Lazar Piper SRB (expire 2027-01-23)

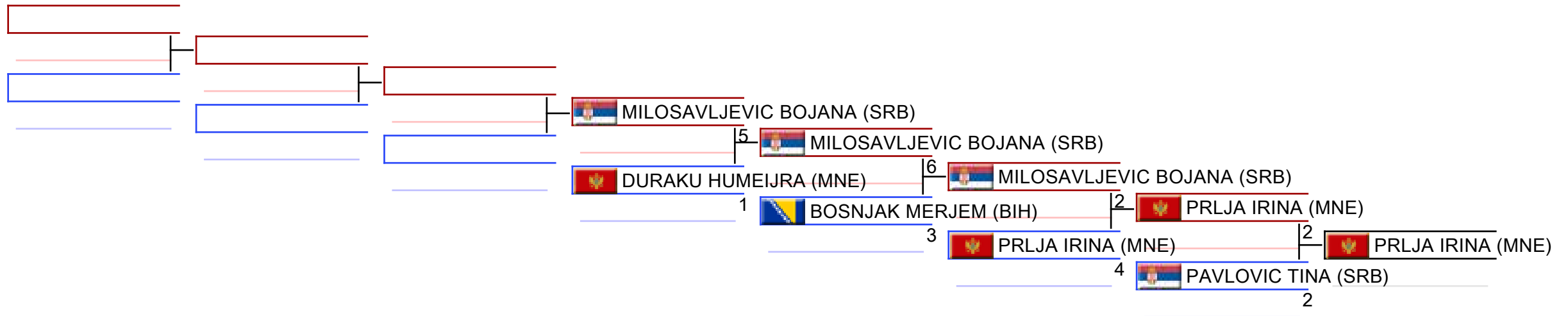

REPECHAGE: (2)

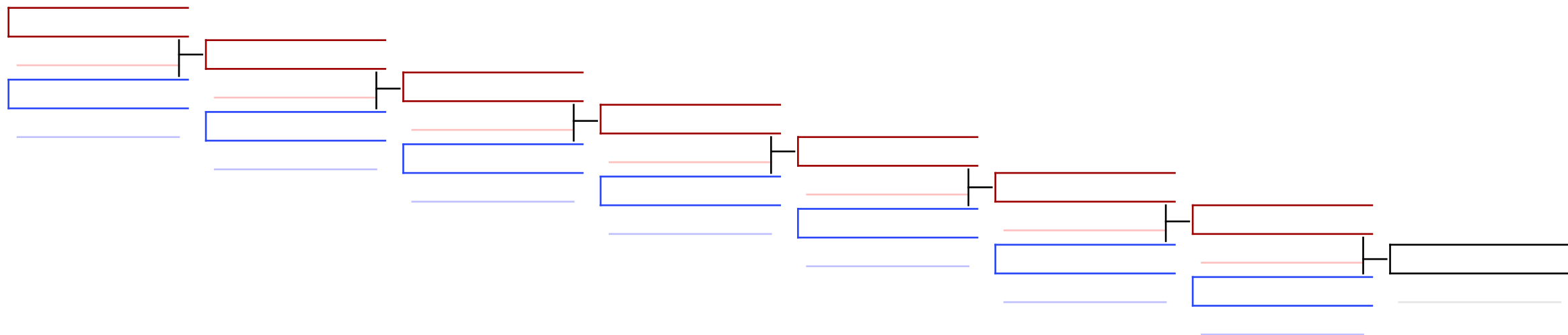

Referees:							
-----------	--	--	--	--	--	--	--

13 Yrs Kumite Male -40 kg

30th Balkan Karate Championships for Children 2026 - Istanbul, Basaksehir Spor Hall, Kayabaşı, TINAZTEPE CADDESİ NO:6, 34494 Başakşehir, İstanbul, TUR2026-05-30

Tatami

4 17:00

Pool

1/1

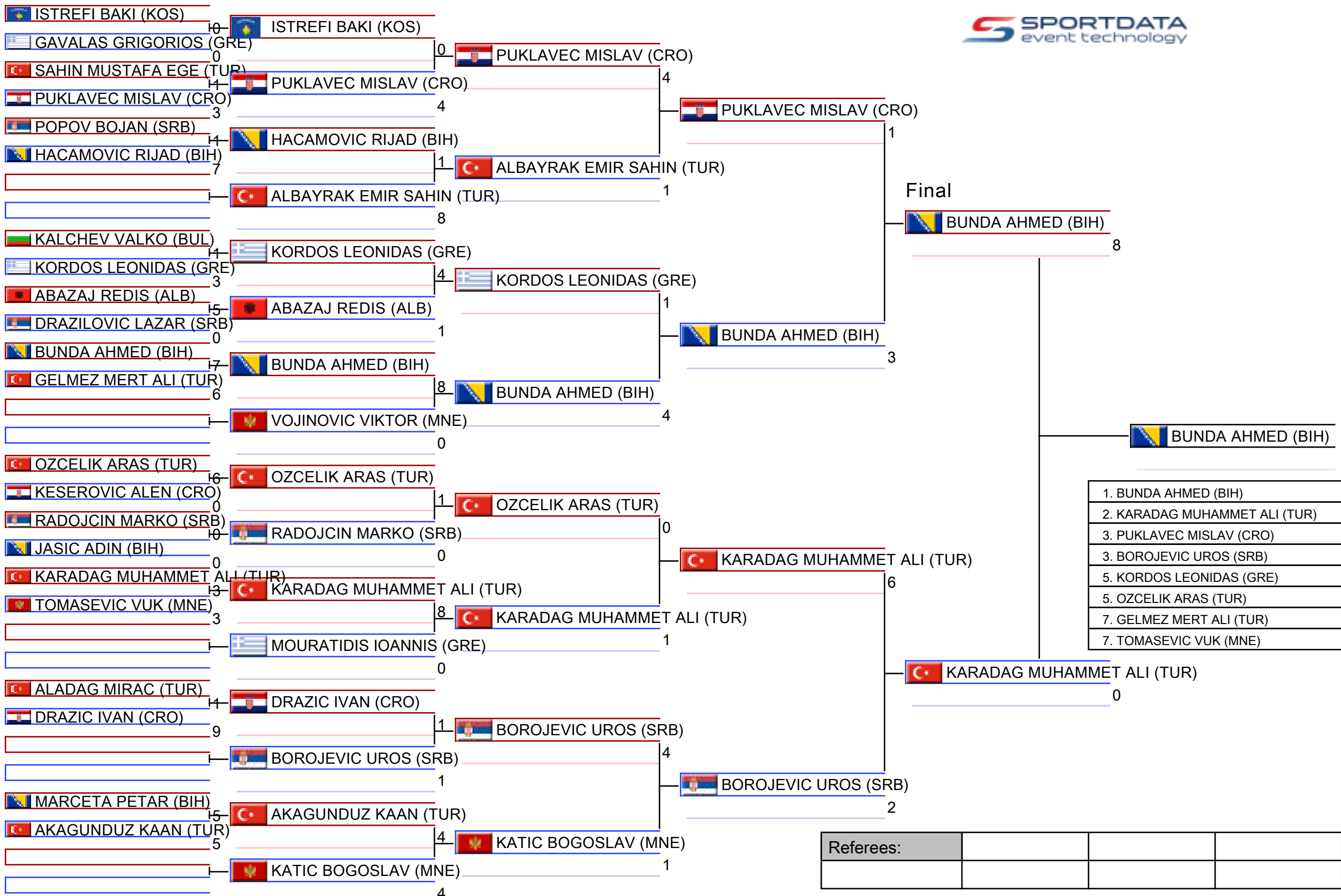

13 Yrs Kumite Male -40 kg

30th Balkan Karate Championships for Children 2026 - Istanbul

2026-05-30

Tatami
4 18:30

Pool
1

(c)sportdata GmbH & Co KG 2000-2026 (2026-05-31 14:44) v 12.2.0 build 1 (2026-05-24 19:07 CET) License: Lazar Piper SRB (expire 2027-01-23)

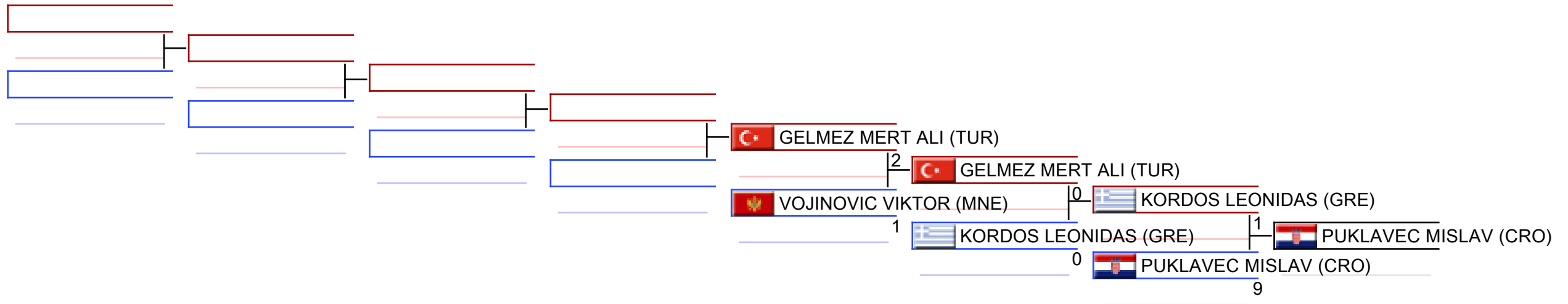

REPECHAGE: (1)

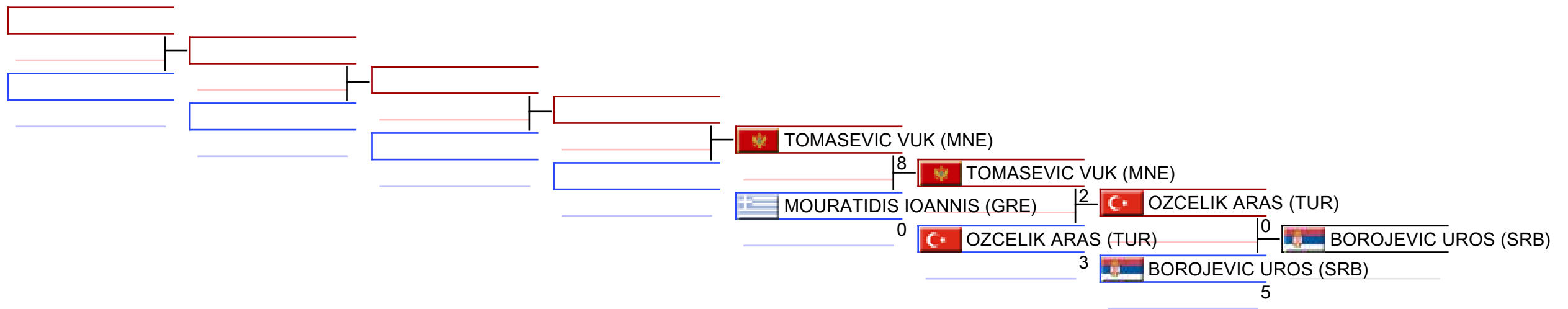

Referees:							
-----------	--	--	--	--	--	--	--

13 Yrs Kumite Male -45 kg

30th Balkan Karate Championships for Children 2026 - Istanbul, Basaksehir Spor Hall, Kayabaşı, TINAZTEPE CADDESİ NO:6, 34494 Başakşehir, İstanbul, TUR2026-05-30

Tatami

3 16:15

Pool

1/2

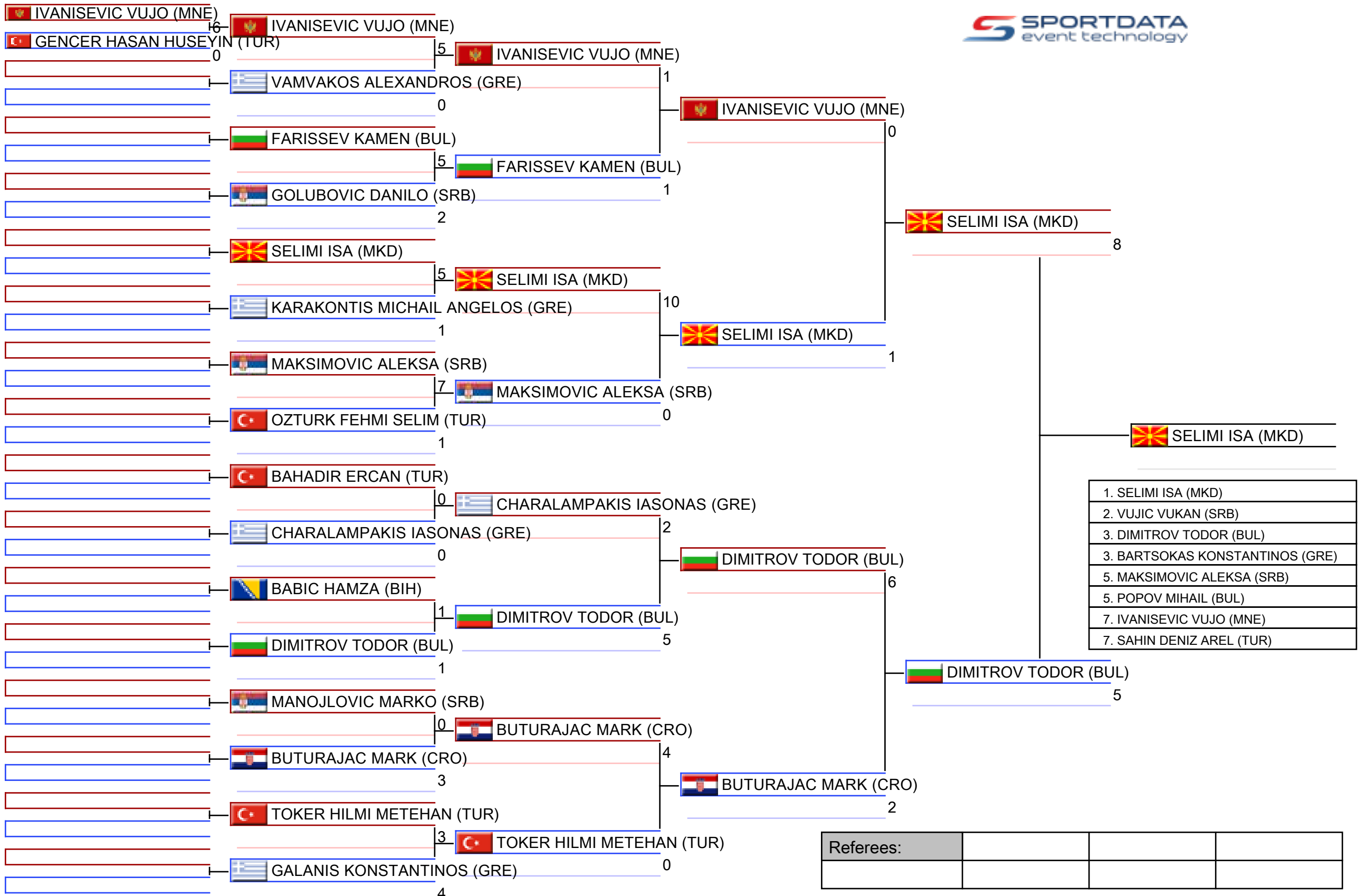

13 Yrs Kumite Male -45 kg

30th Balkan Karate Championships for Children 2026 - Istanbul, Basaksehir Spor Hall, Kayabaşı, TINAZTEPE CADDESİ NO:6, 34494 Başakşehir, İstanbul, TUR2026-05-30

Tatami

3 17:10

Pool

2/2

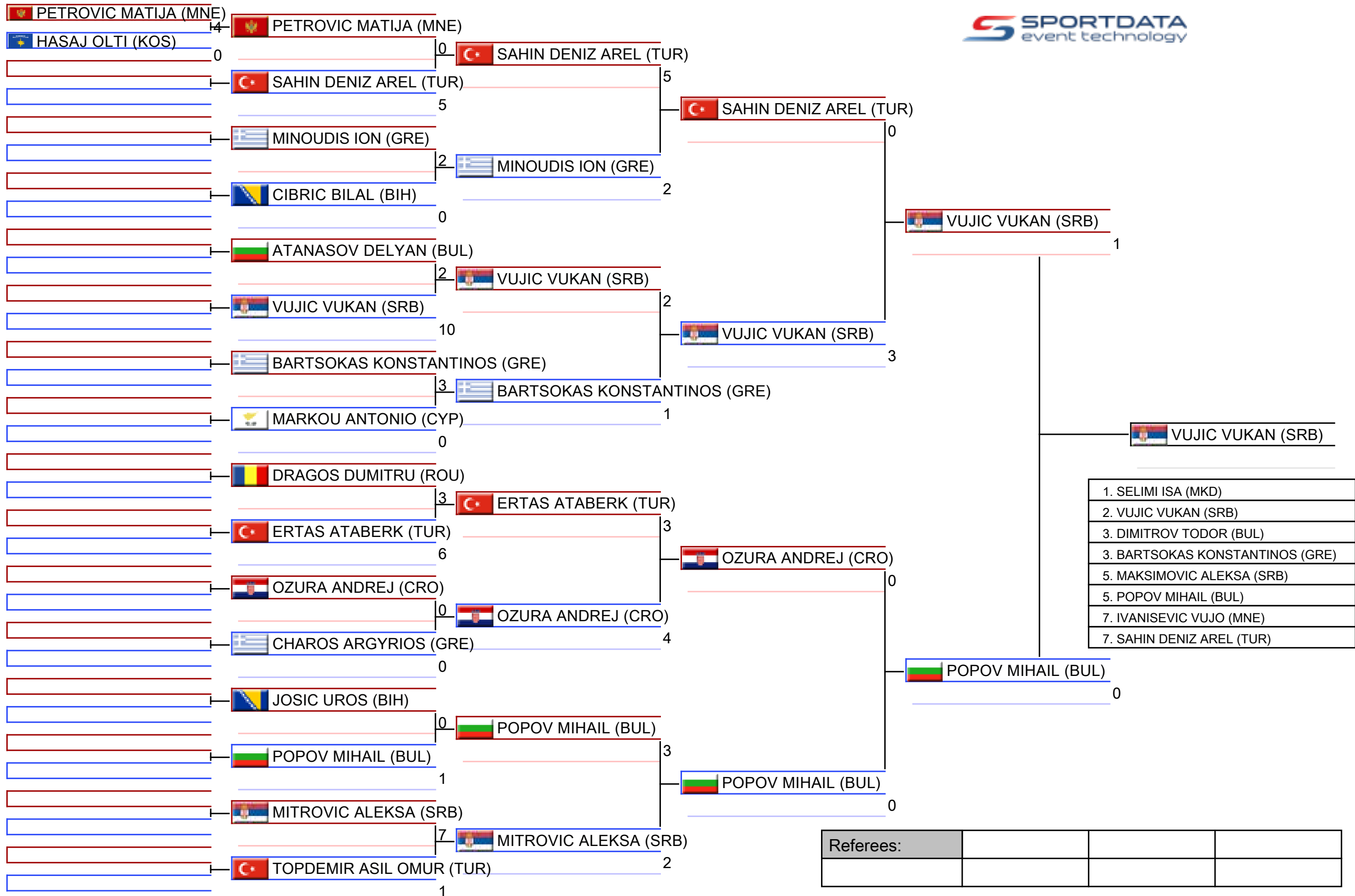

1. SELIMI ISA (MKD)
2. VUJIC VUKAN (SRB)
3. DIMITROV TODOR (BUL)
3. BARTSOKAS KONSTANTINOS (GRE)
5. MAKSIMOVIC ALEKSA (SRB)
5. POPOV MIHAIL (BUL)
7. IVANISEVIC VUJO (MNE)
7. SAHIN DENIZ AREL (TUR)

Referees:			

Pool winner-13 Yrs Kumite Male -45 kg

30th Balkan Karate Championships for Children 2026 - Istanbul, Basaksehir Spor Hall, Kayabaşı, TINAZTEPE CADDESİ NO:6, 34494 Başakşehir, İstanbul, TUR

Tatami

Pool
1/1

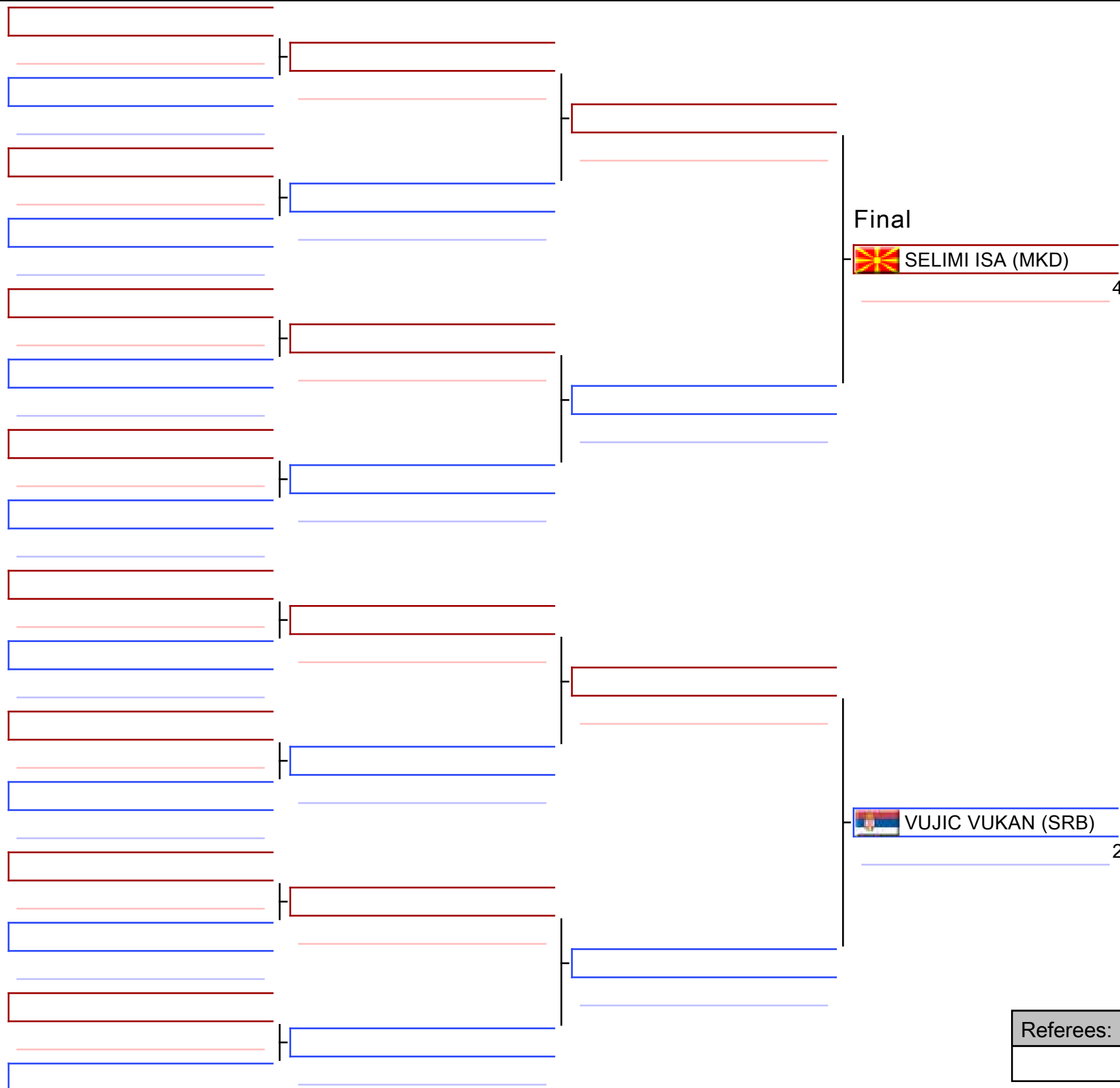

Final

SELIMI ISA (MKD)

4

SELIMI ISA (MKD)

VUJIC VUKAN (SRB)

2

1. SELIMI ISA (MKD)
2. VUJIC VUKAN (SRB)
3. DIMITROV TODOR (BUL)
3. BARTSOKAS KONSTANTINOS (GRE)
5. MAKSIMOVIC ALEKSA (SRB)
5. POPOV MIHAIL (BUL)
7. IVANISEVIC VUJO (MNE)
7. SAHIN DENIZ AREL (TUR)

Referees:			

13 Yrs Kumite Male -45 kg

30th Balkan Karate Championships for Children 2026 - Istanbul

2026-05-30

Tatami
3 18:05

Pool
1,2

(c)sportdata GmbH & Co KG 2000-2026 (2026-05-31 14:44) v 12.2.0 build 1 (2026-05-24 19:07 CET) License: Lazar Piper SRB (expire 2027-01-23)

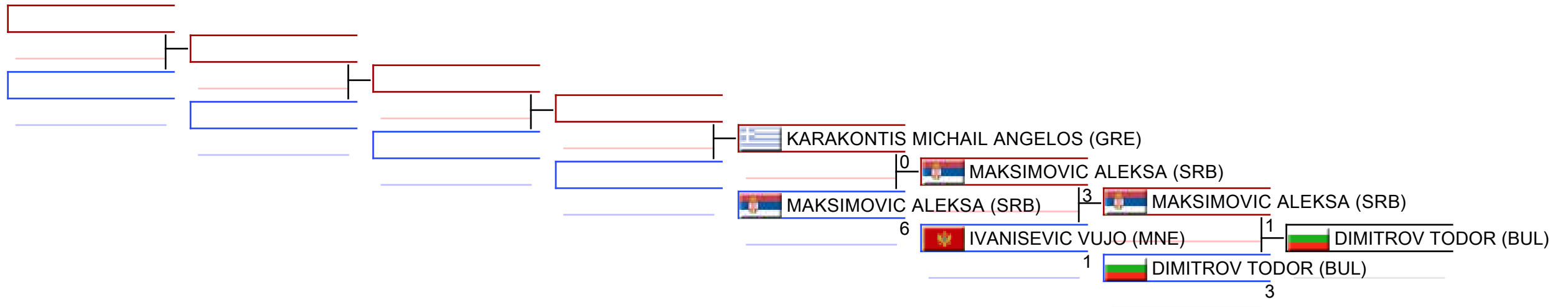

REPECHAGE: (1,2)

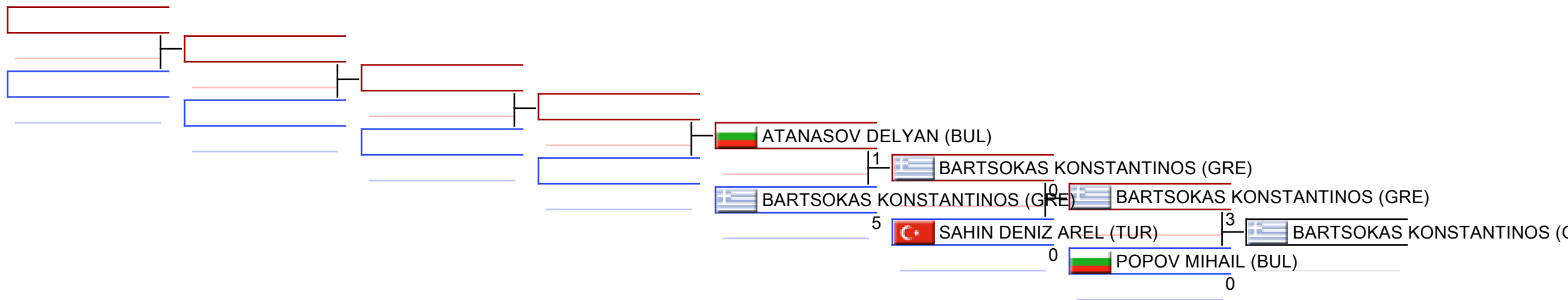

Referees:							
-----------	--	--	--	--	--	--	--

13 Yrs Kumite Male -50 kg

30th Balkan Karate Championships for Children 2026 - Istanbul, Basaksehir Spor Hall, Kayabaşı, TINAZTEPE CADDESİ NO:6, 34494 Başakşehir, İstanbul, TUR2026-05-31

Tatami

5 12:25

Pool

1/1

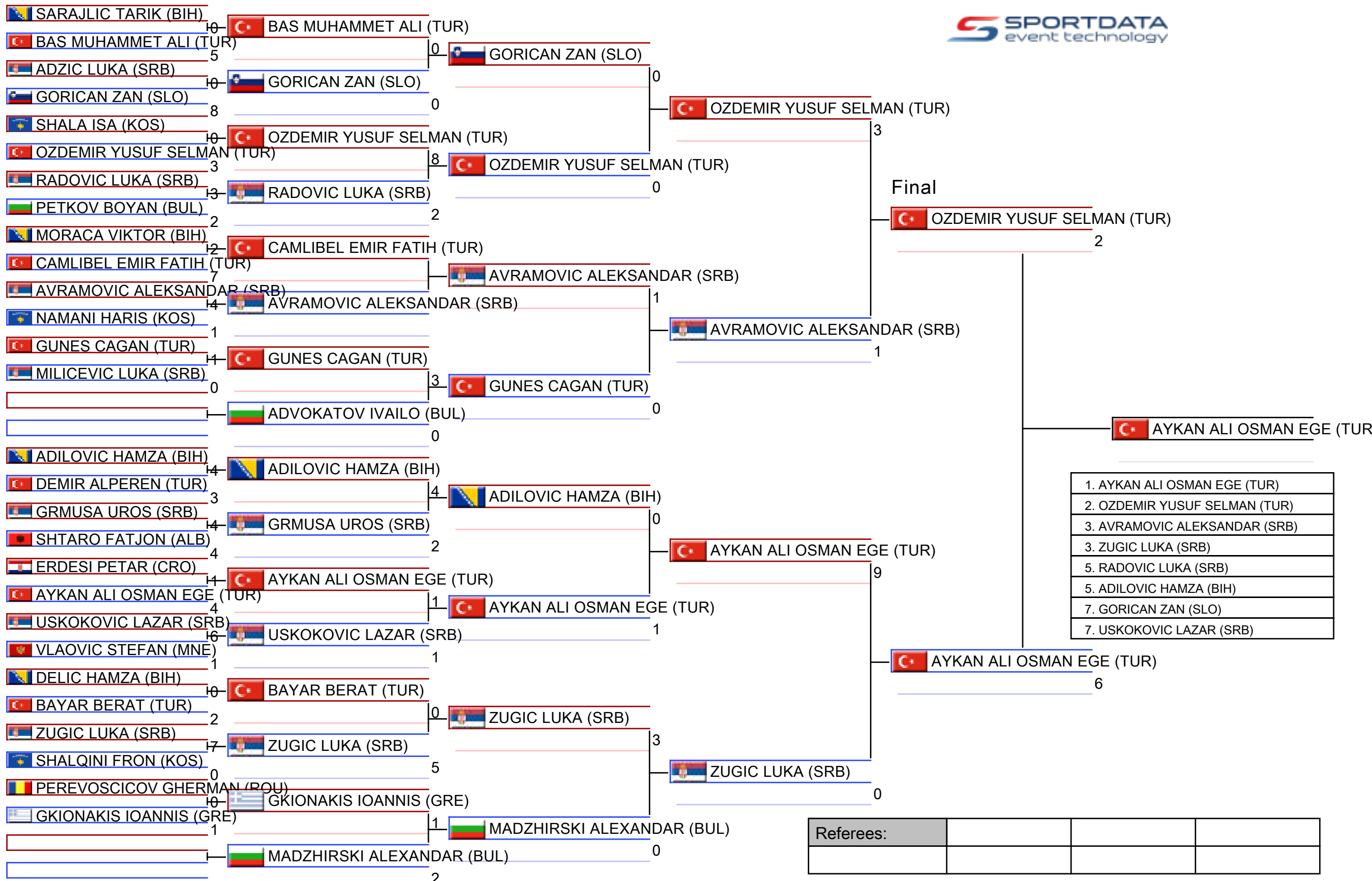

13 Yrs Kumite Male -50 kg

30th Balkan Karate Championships for Children 2026 - Istanbul

2026-05-31

Tatami
5 14:05

Pool
1

(c)sportdata GmbH & Co KG 2000-2026 (2026-05-31 14:44) v 12.2.0 build 1 (2026-05-24 19:07 CET) License: Lazar Piper SRB (expire 2027-01-23)

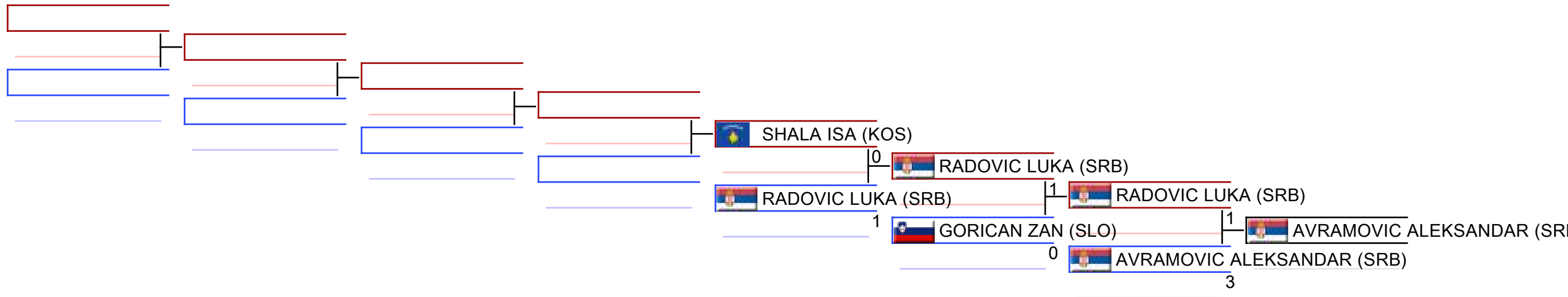

REPECHAGE: (1)

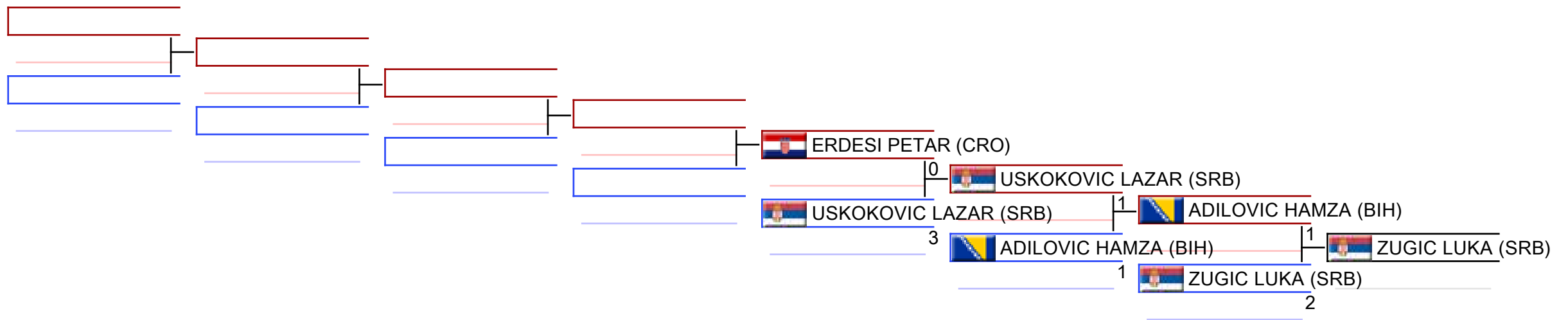

Referees:							
-----------	--	--	--	--	--	--	--

13 Yrs Kumite Male -55 kg

30th Balkan Karate Championships for Children 2026 - Istanbul, Basaksehir Spor Hall, Kayabaşı, TINAZTEPE CADDESİ NO:6, 34494 Başakşehir, İstanbul, TUR2026-05-30

Tatami

1 17:00

Pool

1/1

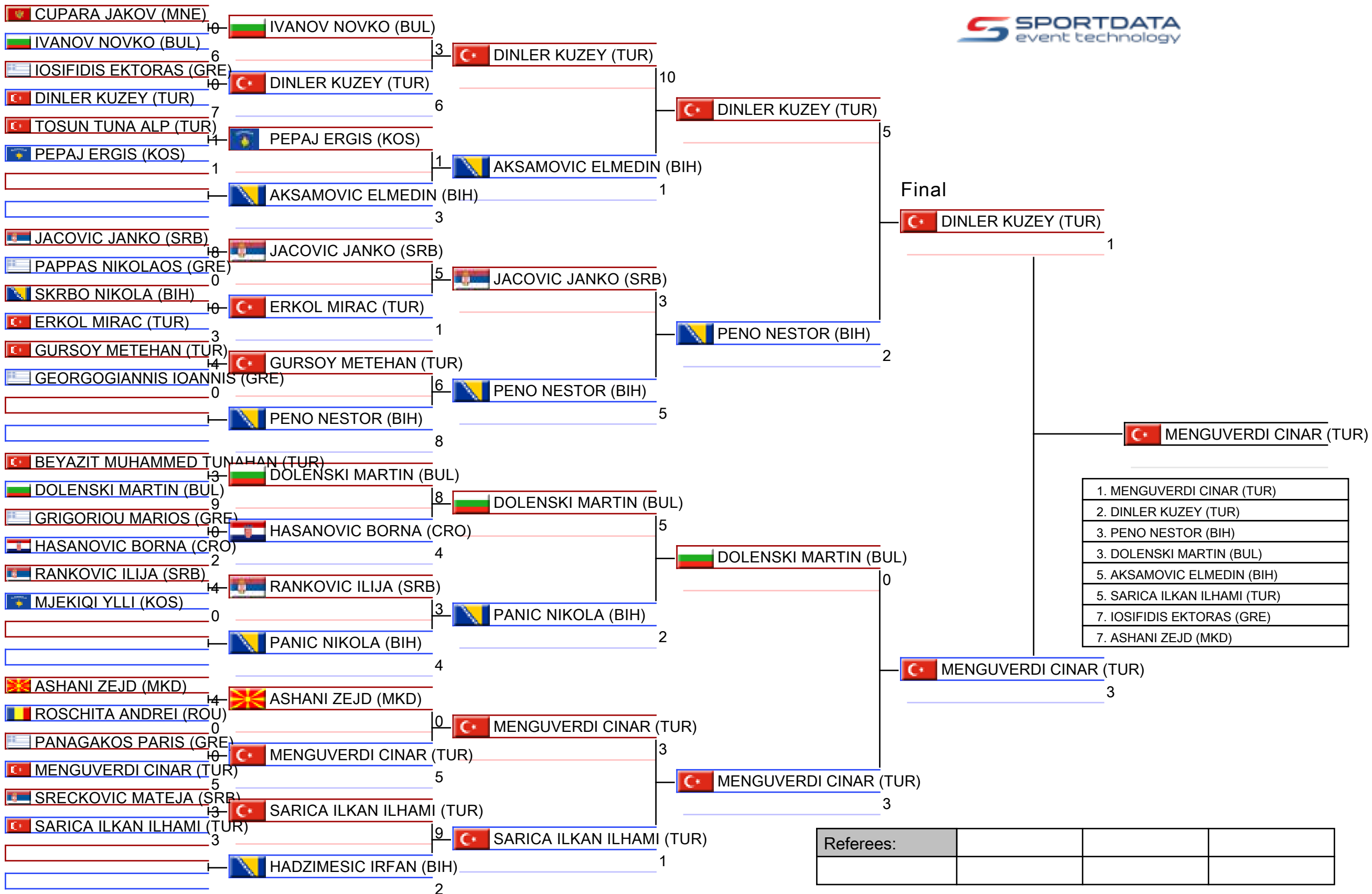

13 Yrs Kumite Male -55 kg

30th Balkan Karate Championships for Children 2026 - Istanbul

2026-05-30

Tatami
1 18:40

Pool
1

(c)sportdata GmbH & Co KG 2000-2026 (2026-05-31 14:44) v 12.2.0 build 1 (2026-05-24 19:07 CET) License: Lazar Piper SRB (expire 2027-01-23)

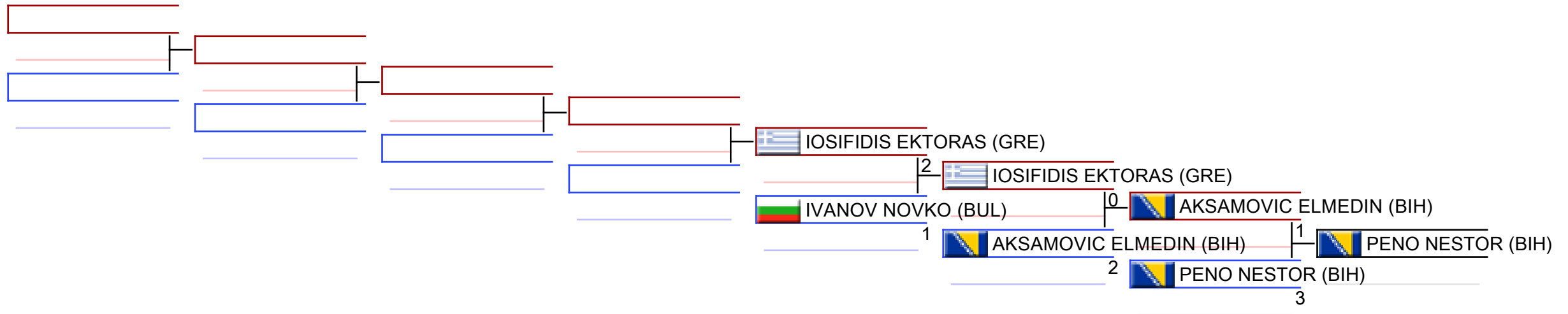

REPECHAGE: (1)

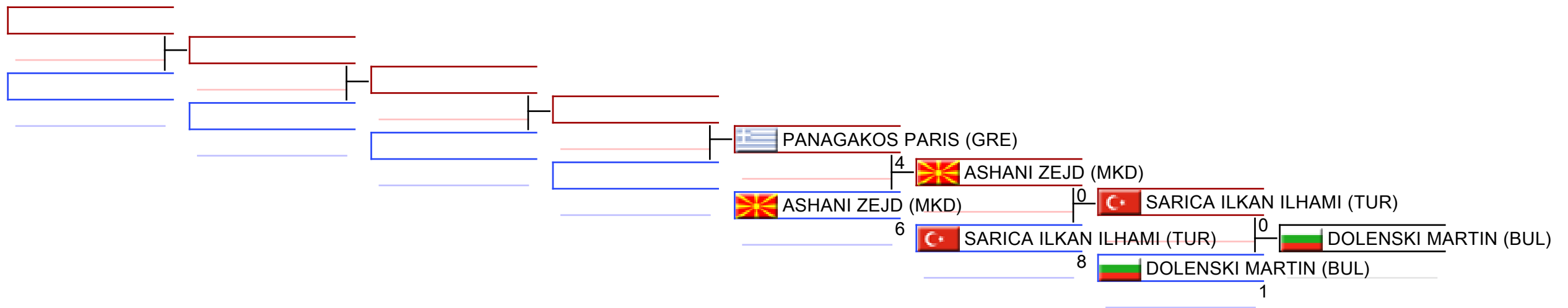

Referees:							
-----------	--	--	--	--	--	--	--

13 Yrs Kumite Male 55+ kg

30th Balkan Karate Championships for Children 2026 - Istanbul, Basaksehir Spor Hall, Kayabaşı, TINAZTEPE CADDESİ NO:6, 34494 Başakşehir, İstanbul, TUR2026-05-30

Tatami

2 15:50

Pool

1/2

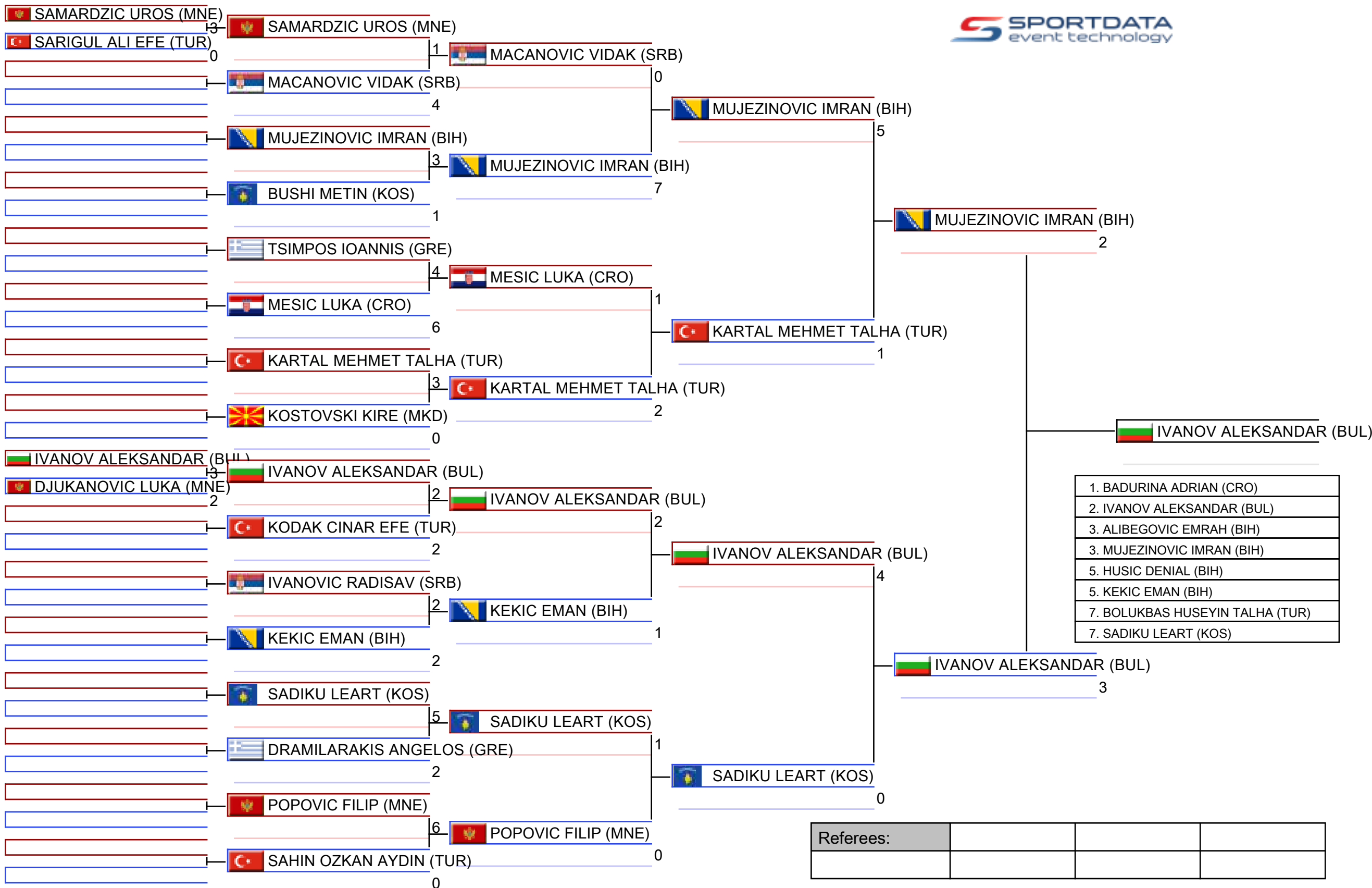

13 Yrs Kumite Male 55+ kg

30th Balkan Karate Championships for Children 2026 - Istanbul, Basaksehir Spor Hall, Kayabaşı, TINAZTEPE CADDESİ NO:6, 34494 Başakşehir, İstanbul, TUR2026-05-30

Tatami

2 16:50

Pool

2/2

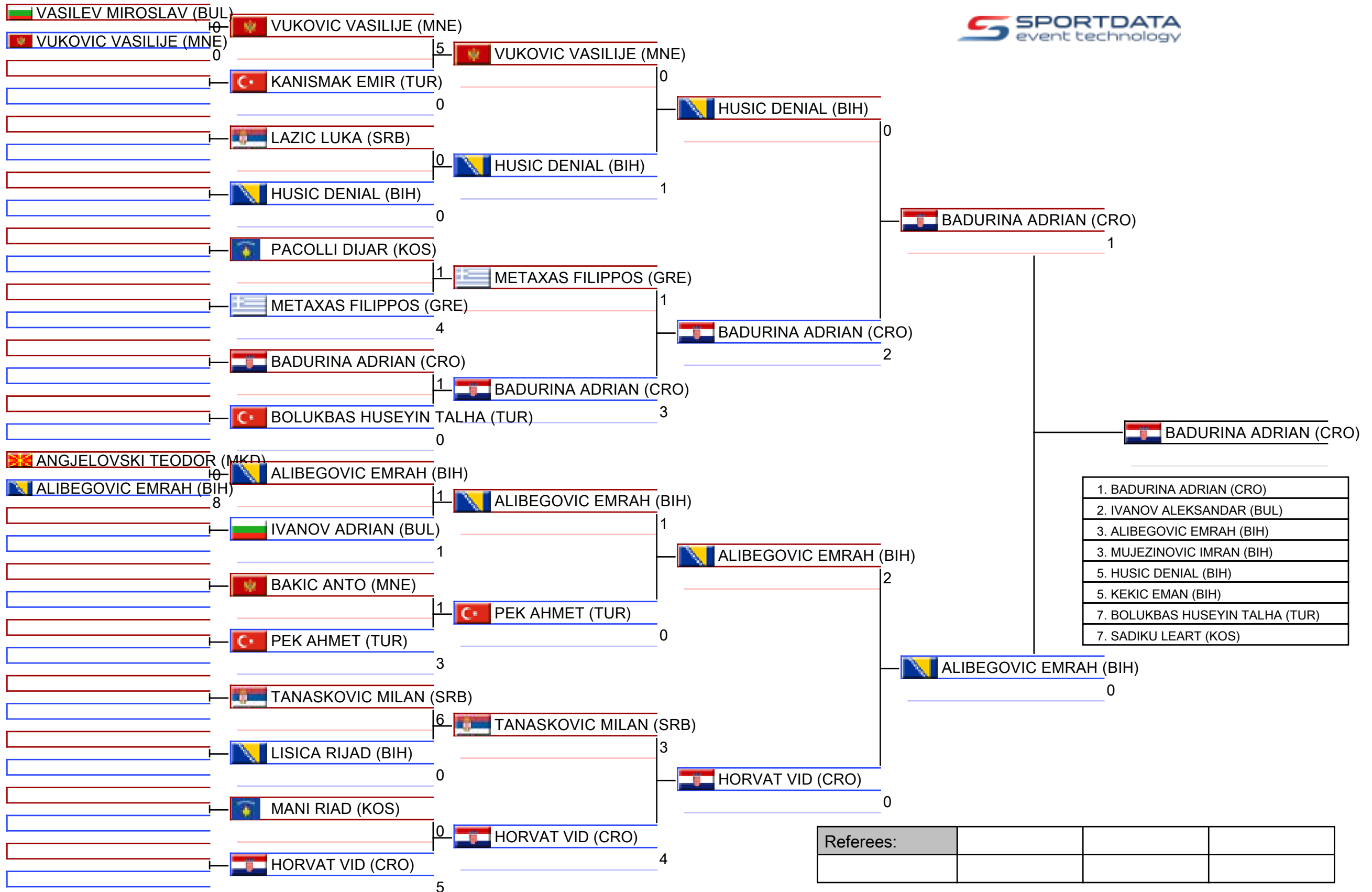

Referees:			

Pool winner-13 Yrs Kumite Male 55+ kg

30th Balkan Karate Championships for Children 2026 - Istanbul, Basaksehir Spor Hall, Kayabaşı, TINAZTEPE CADDESİ NO:6, 34494 Başakşehir, İstanbul, TUR

Tatami

Pool

1/1

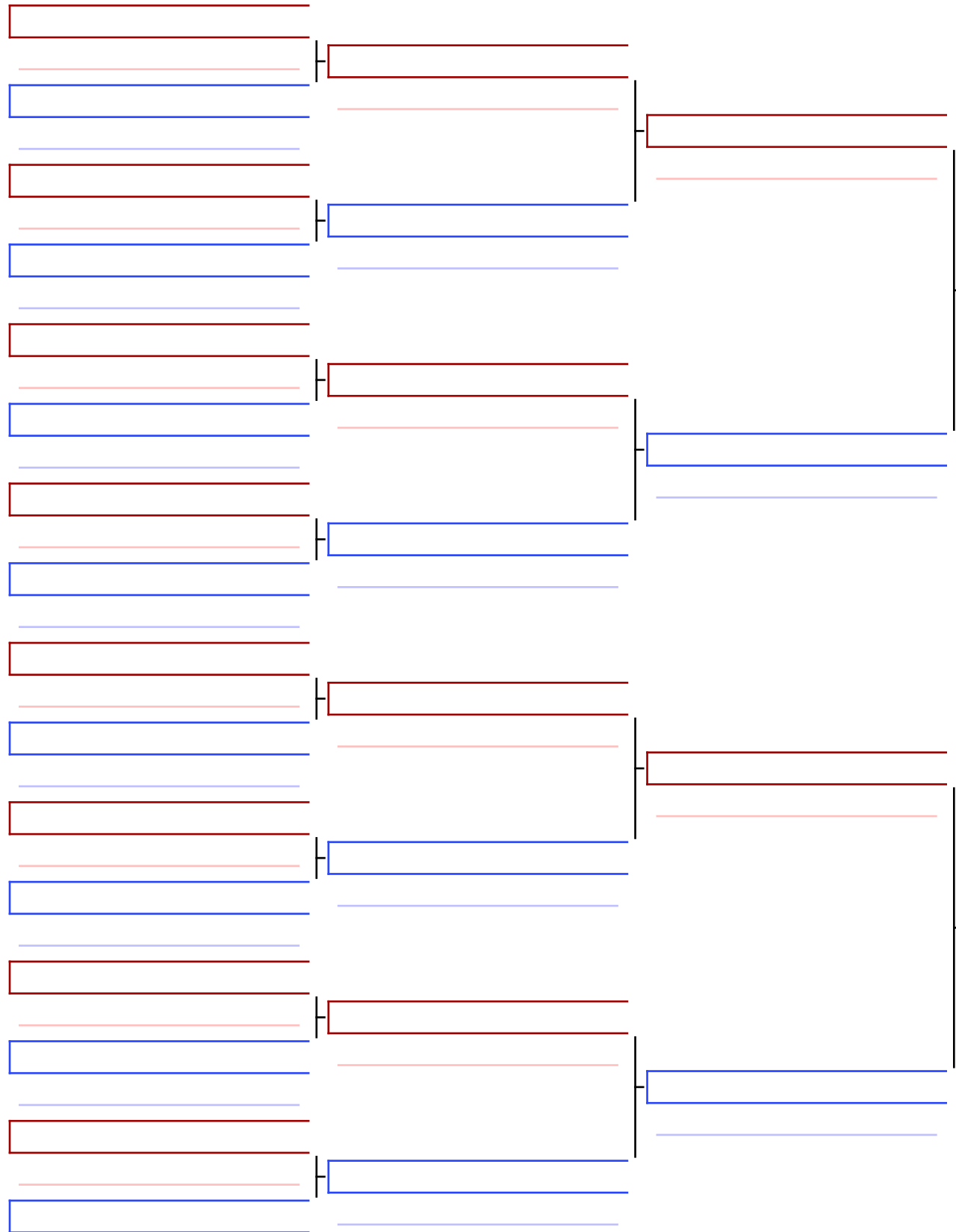

Final

 **IVANOV ALEKSANDAR (BUL)**

4

 **BADURINA ADRIAN (CRO)**

 **BADURINA ADRIAN (CRO)**

5

1. BADURINA ADRIAN (CRO)
2. IVANOV ALEKSANDAR (BUL)
3. ALIBEGOVIC EMRAH (BIH)
3. MUJEZINOVIC IMRAN (BIH)
5. HUSIC DENIAL (BIH)
5. KEKIC EMAN (BIH)
7. BOLUKBAS HUSEYIN TALHA (TUR)
7. SADIKU LEART (KOS)

Referees:			

13 Yrs Kumite Male 55+ kg

30th Balkan Karate Championships for Children 2026 - Istanbul

2026-05-30

Tatami
2 17:50

Pool
1,2

(c)sportdata GmbH & Co KG 2000-2026 (2026-05-31 14:44) v 12.2.0 build 1 (2026-05-24 19:07 CET) License: Lazar Piper SRB (expire 2027-01-23)

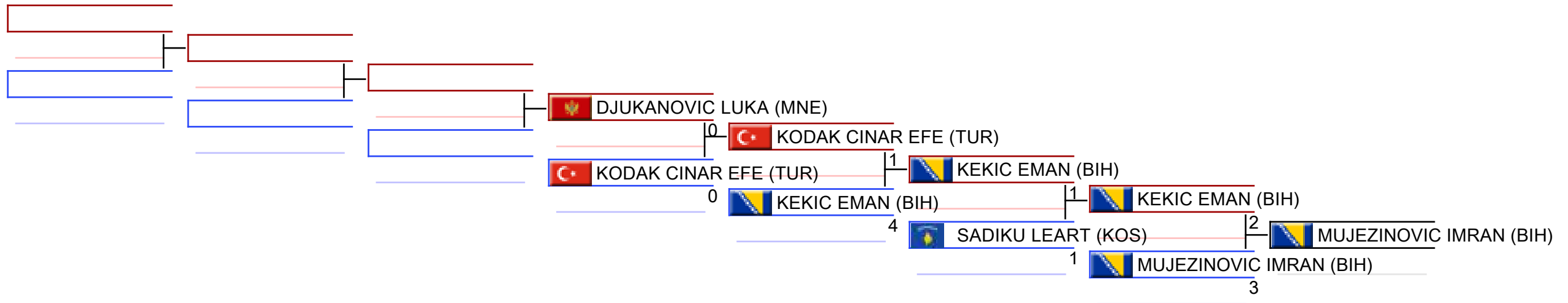

REPECHAGE: (1,2)

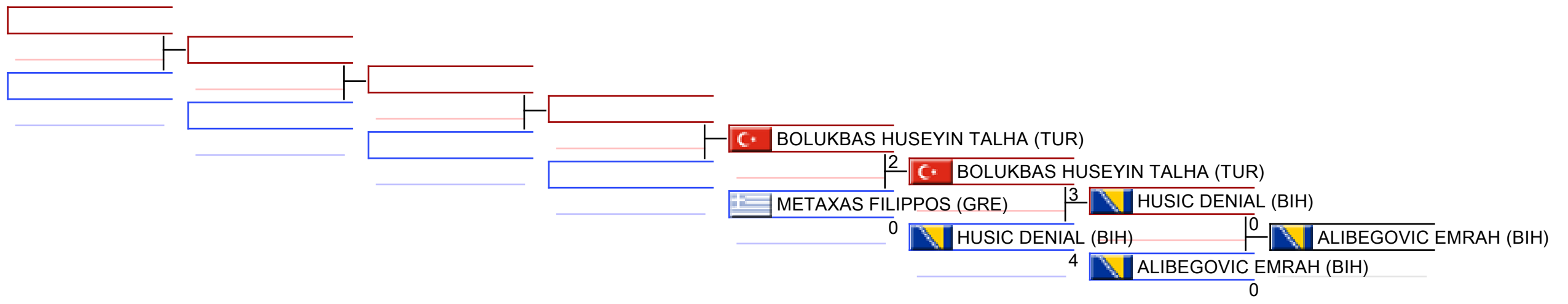

Referees:							
-----------	--	--	--	--	--	--	--

8-9 Yrs Kata Team Female

30th Balkan Karate Championships for Children 2026 - Istanbul, Basaksehir Spor Hall, Kayabaşı, TINAZTEPE CADDESİ NO:6, 34494 Başakşehir, İstanbul, TUR2026-05-31

Tatami
1 09:00

Pool
1/1

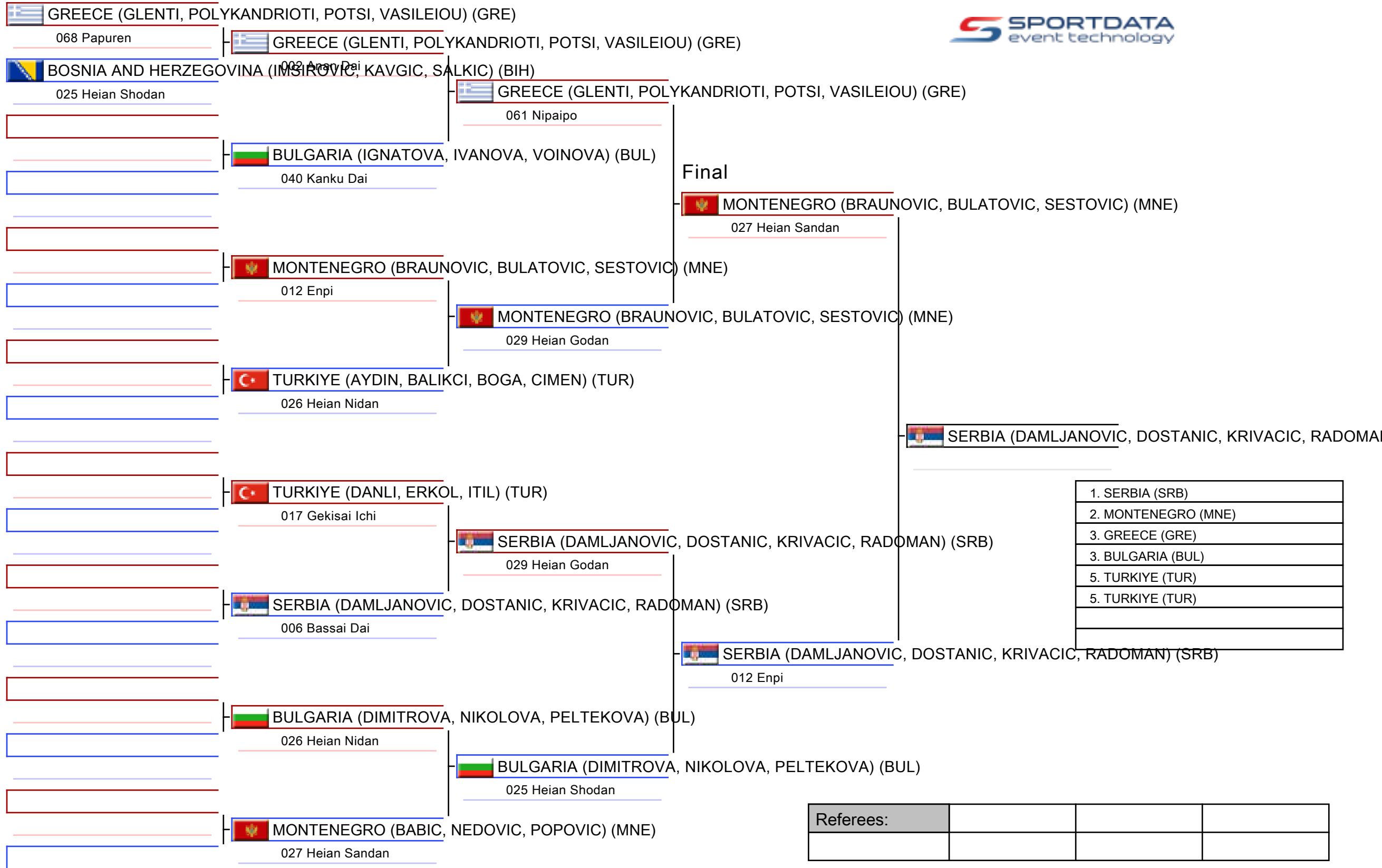

8-9 Yrs Kata Team Female

30th Balkan Karate Championships for Children 2026 - Istanbul

2026-05-31

Tatami
1 09:35

Pool
1

(c)sportdata GmbH & Co KG 2000-2026 (2026-05-31 14:44) v 12.2.0 build 1 (2026-05-24 19:07 CET) License: Lazar Piper SRB (expire 2027-01-23)

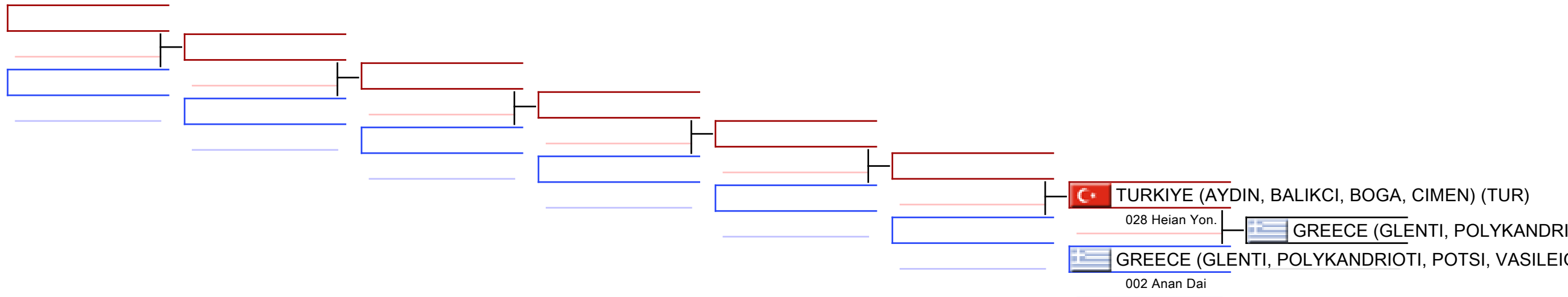

REPECHAGE: (1)

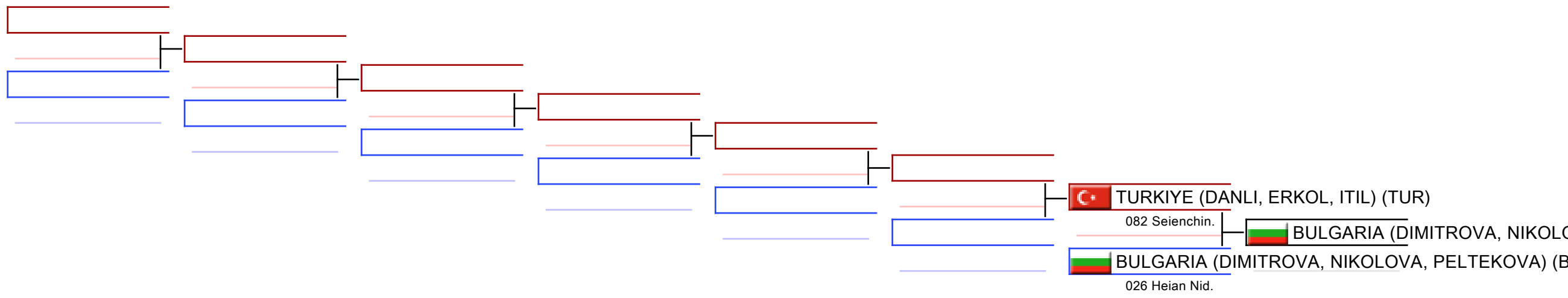

Referees:							
-----------	--	--	--	--	--	--	--

8-9 Yrs Kata Team Male

30th Balkan Karate Championships for Children 2026 - Istanbul, Basaksehir Spor Hall, Kayabaşı, TINAZTEPE CADDESİ NO:6, 34494 Başakşehir, İstanbul, TUR2026-05-31

Tatami
2 09:00

Pool
1/1

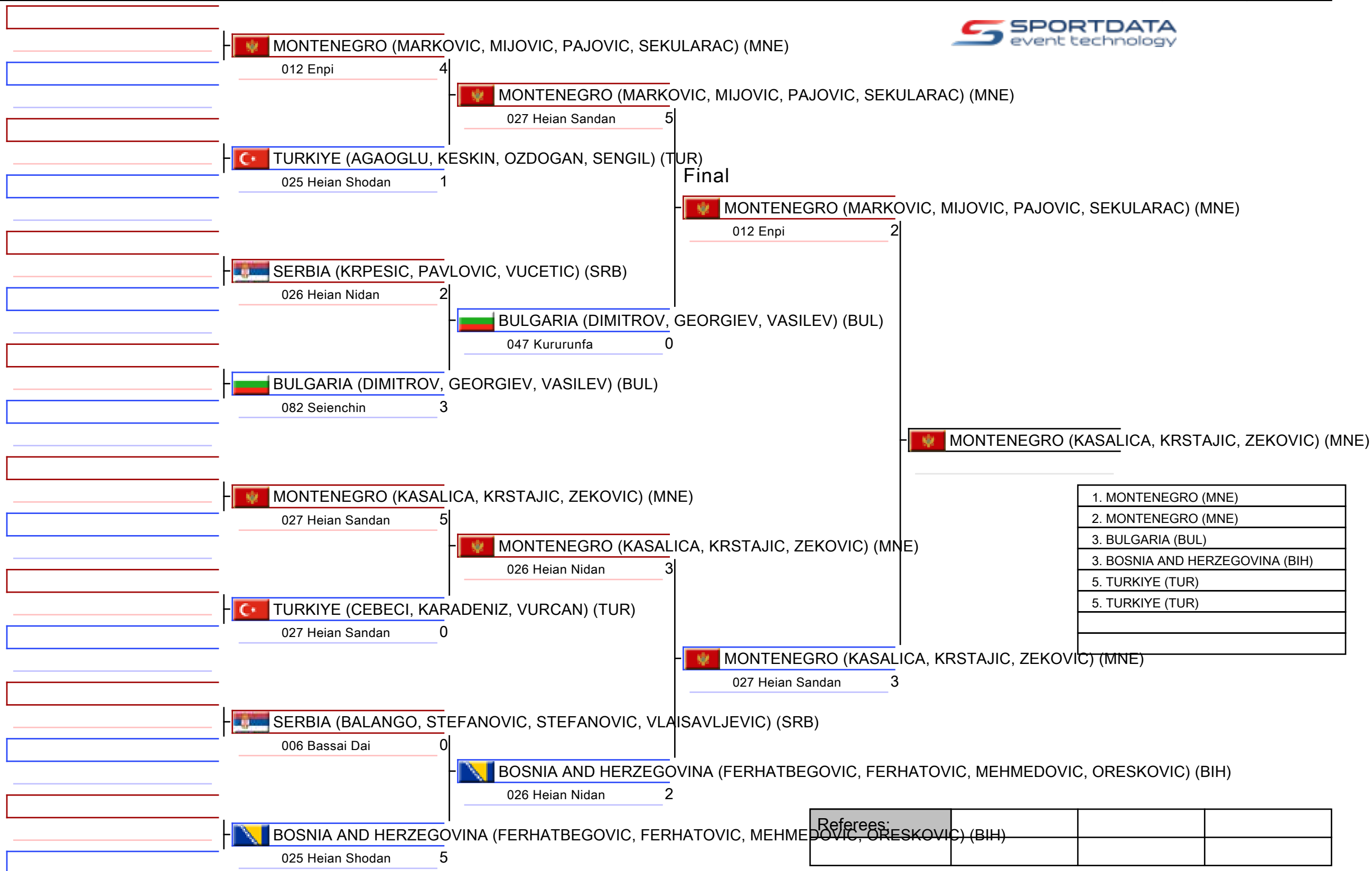

8-9 Yrs Kata Team Male

30th Balkan Karate Championships for Children 2026 - Istanbul

2026-05-31

Tatami
2 09:30

Pool
1

(c)sportdata GmbH & Co KG 2000-2026 (2026-05-31 14:45) v 12.2.0 build 1 (2026-05-24 19:07 CET) License: Lazar Piper SRB (expire 2027-01-23)

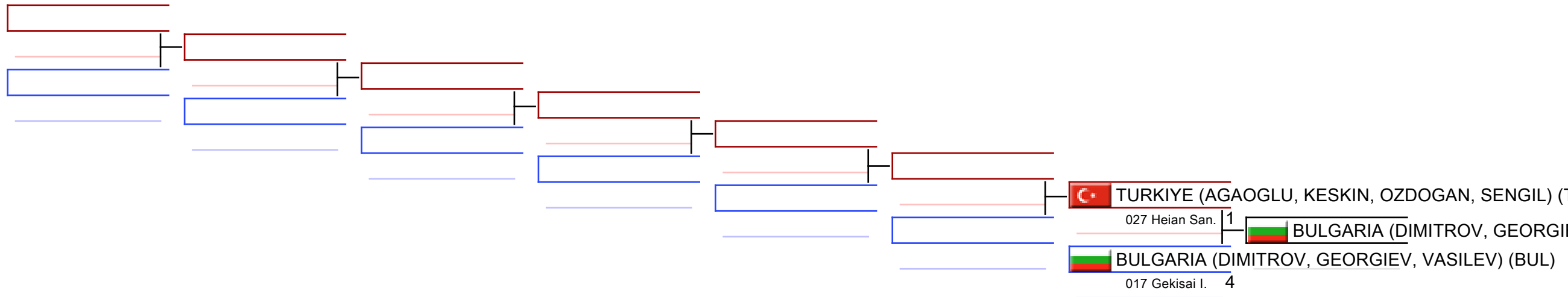

REPECHAGE: (1)

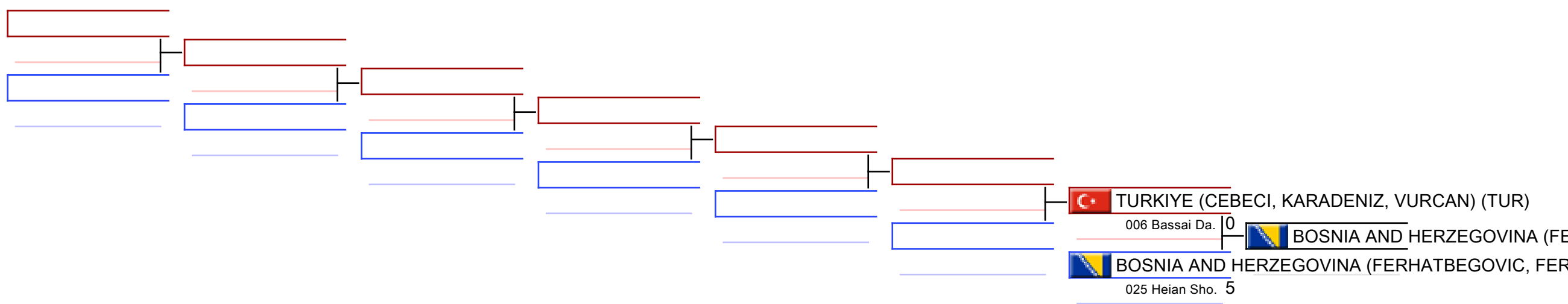

Referees:							
-----------	--	--	--	--	--	--	--

8 Yrs Kata Individual Female

30th Balkan Karate Championships for Children 2026 - Istanbul, Basaksehir Spor Hall, Kayabaşı, TINAZTEPE CADDESİ NO:6, 34494 Başakşehir, İstanbul, TUR2026-05-30

Tatami
6 09:00

Pool
1/1

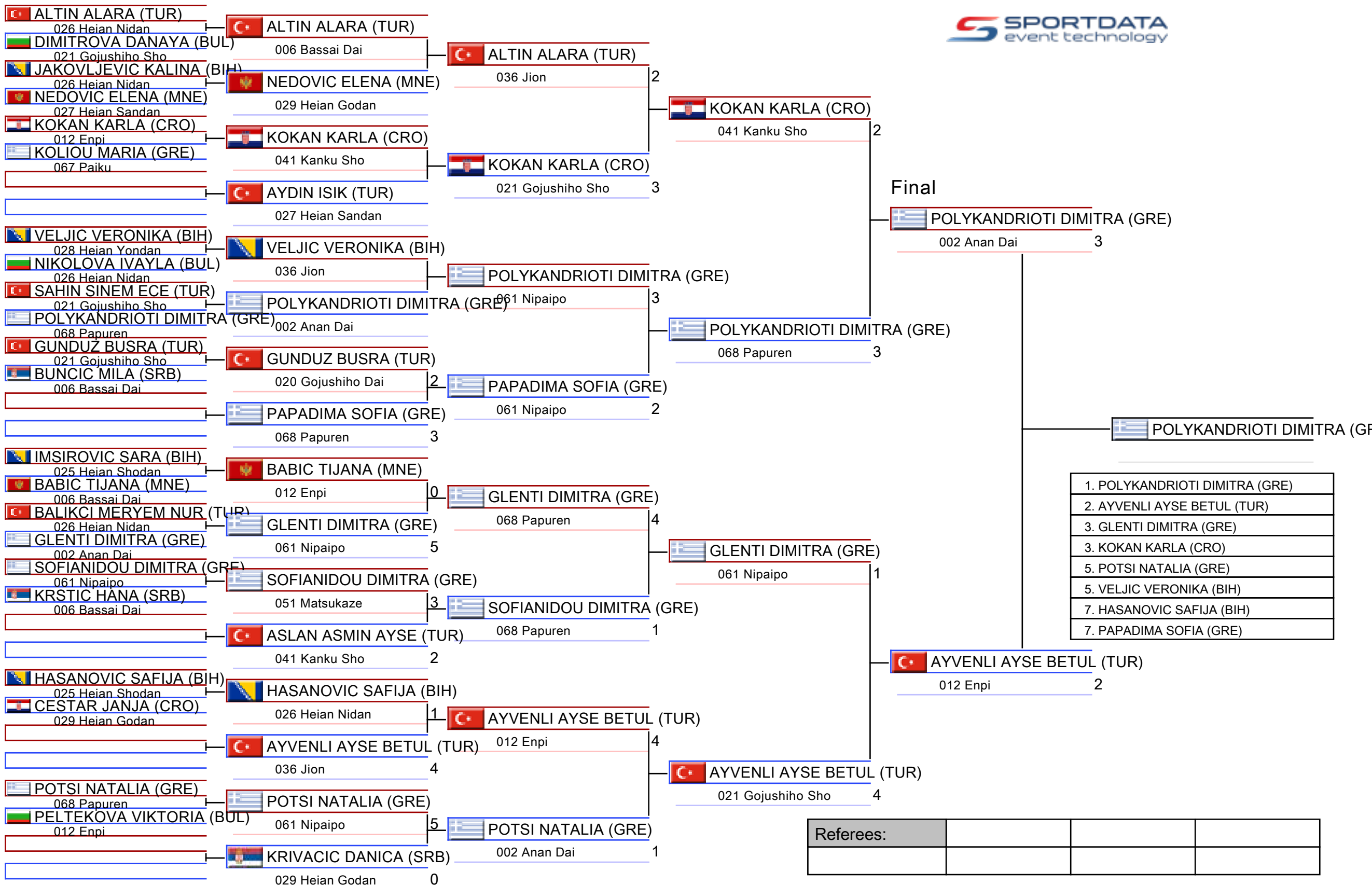

8 Yrs Kata Individual Female

30th Balkan Karate Championships for Children 2026 - Istanbul

2026-05-30

Tatami
6 11:05

Pool
1

(c)sportdata GmbH & Co KG 2000-2026 (2026-05-31 14:44) v 12.2.0 build 1 (2026-05-24 19:07 CET) License: Lazar Piper SRB (expire 2027-01-23)

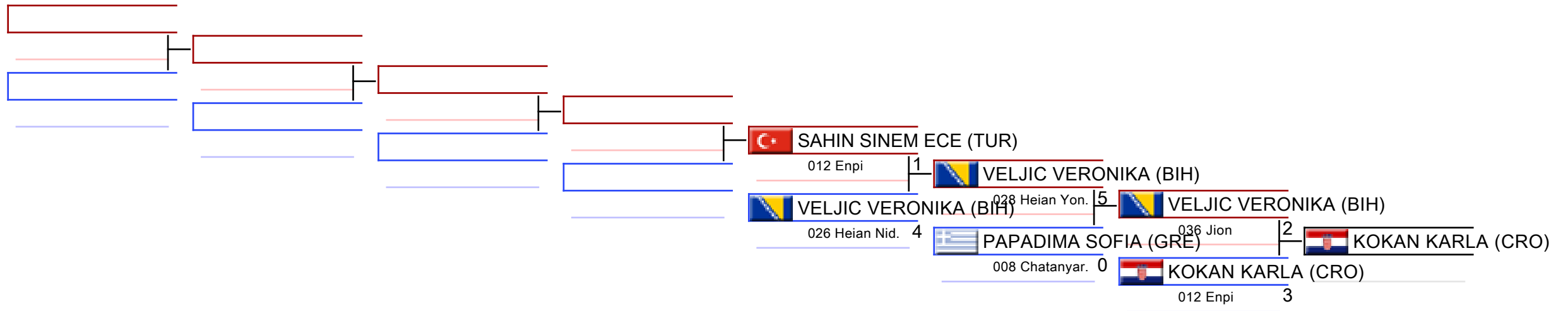

REPECHAGE: (1)

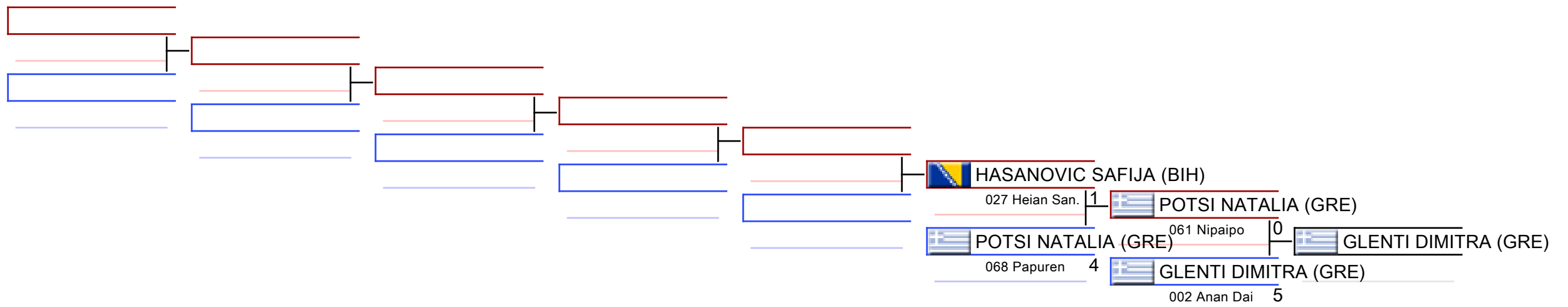

Referees:							
-----------	--	--	--	--	--	--	--

8 Yrs Kata Individual Male

30th Balkan Karate Championships for Children 2026 - Istanbul, Basaksehir Spor Hall, Kayabaşı, TINAZTEPE CADDESİ NO:6, 34494 Başakşehir, İstanbul, TUR2026-05-29

Tatami
6 09:00

Pool
1/1

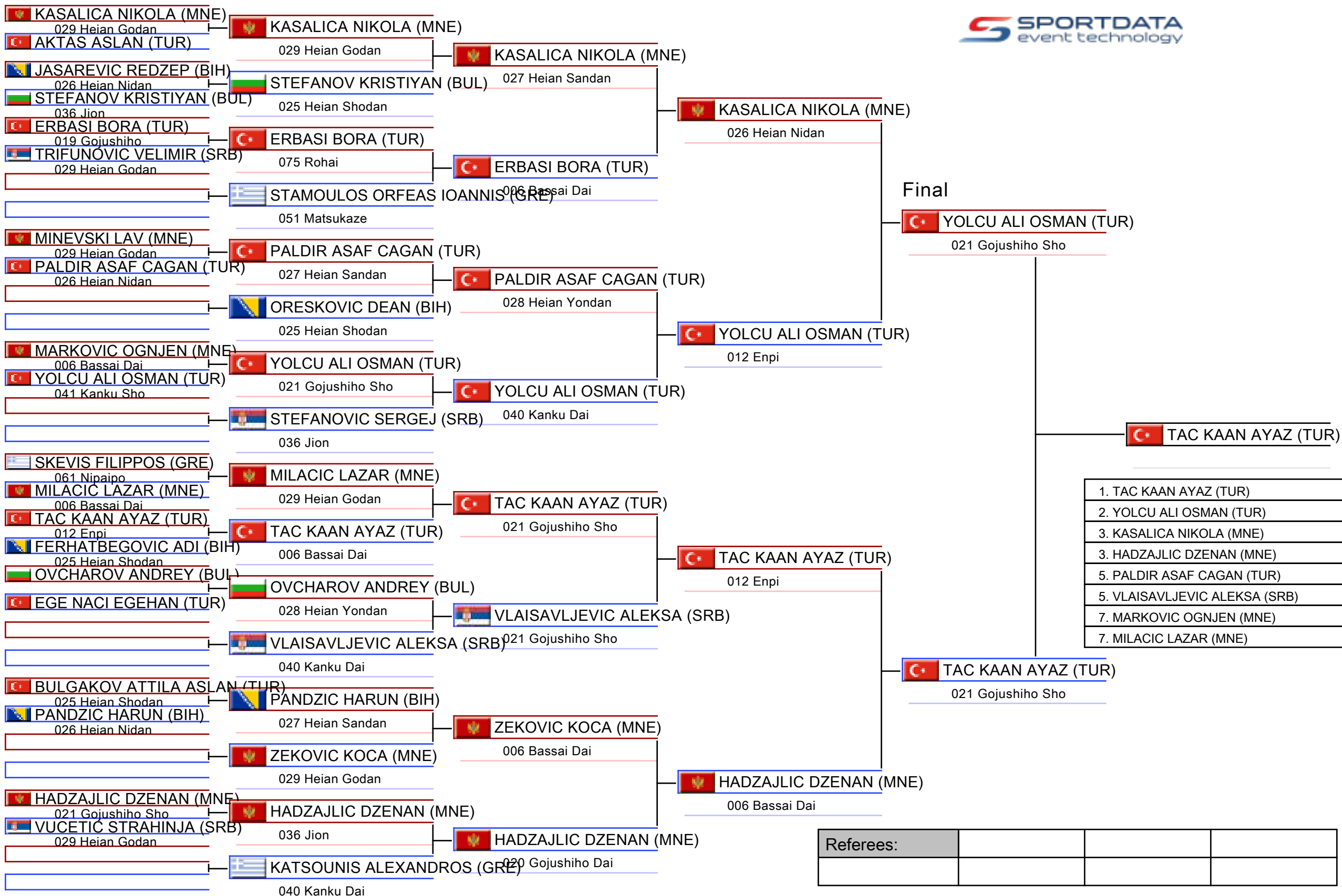

8 Yrs Kata Individual Male

30th Balkan Karate Championships for Children 2026 - Istanbul

2026-05-29

Tatami
6 11:00

Pool
1

(c)sportdata GmbH & Co KG 2000-2026 (2026-05-31 14:44) v 12.2.0 build 1 (2026-05-24 19:07 CET) License: Lazar Piper SRB (expire 2027-01-23)

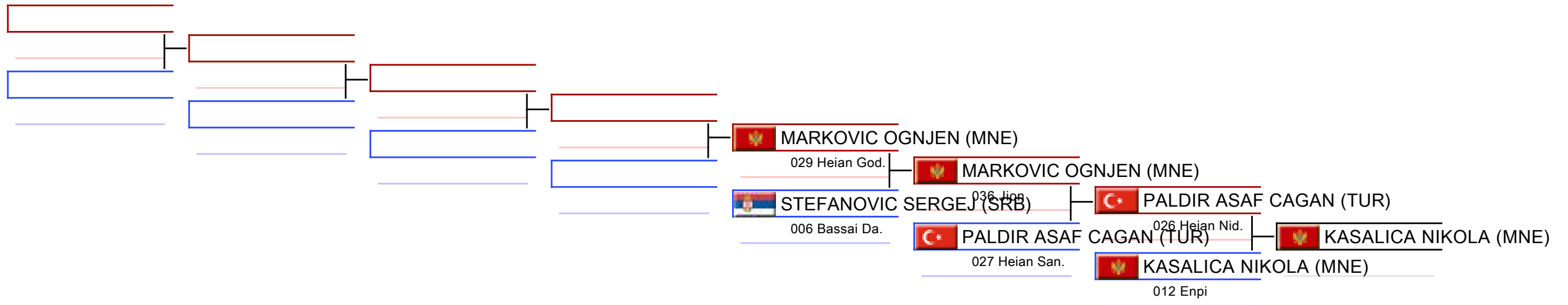

REPECHAGE: (1)

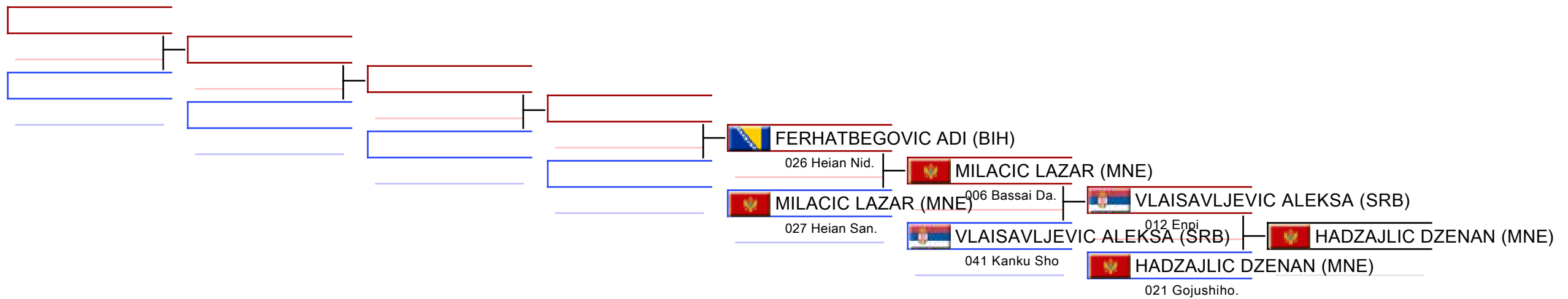

Referees:							
-----------	--	--	--	--	--	--	--

9 Yrs Kata Individual Female

30th Balkan Karate Championships for Children 2026 - Istanbul, Basaksehir Spor Hall, Kayabaşı, TINAZTEPE CADDESİ NO:6, 34494 Başakşehir, İstanbul, TUR2026-05-30

Tatami
5 09:00

Pool
1/1

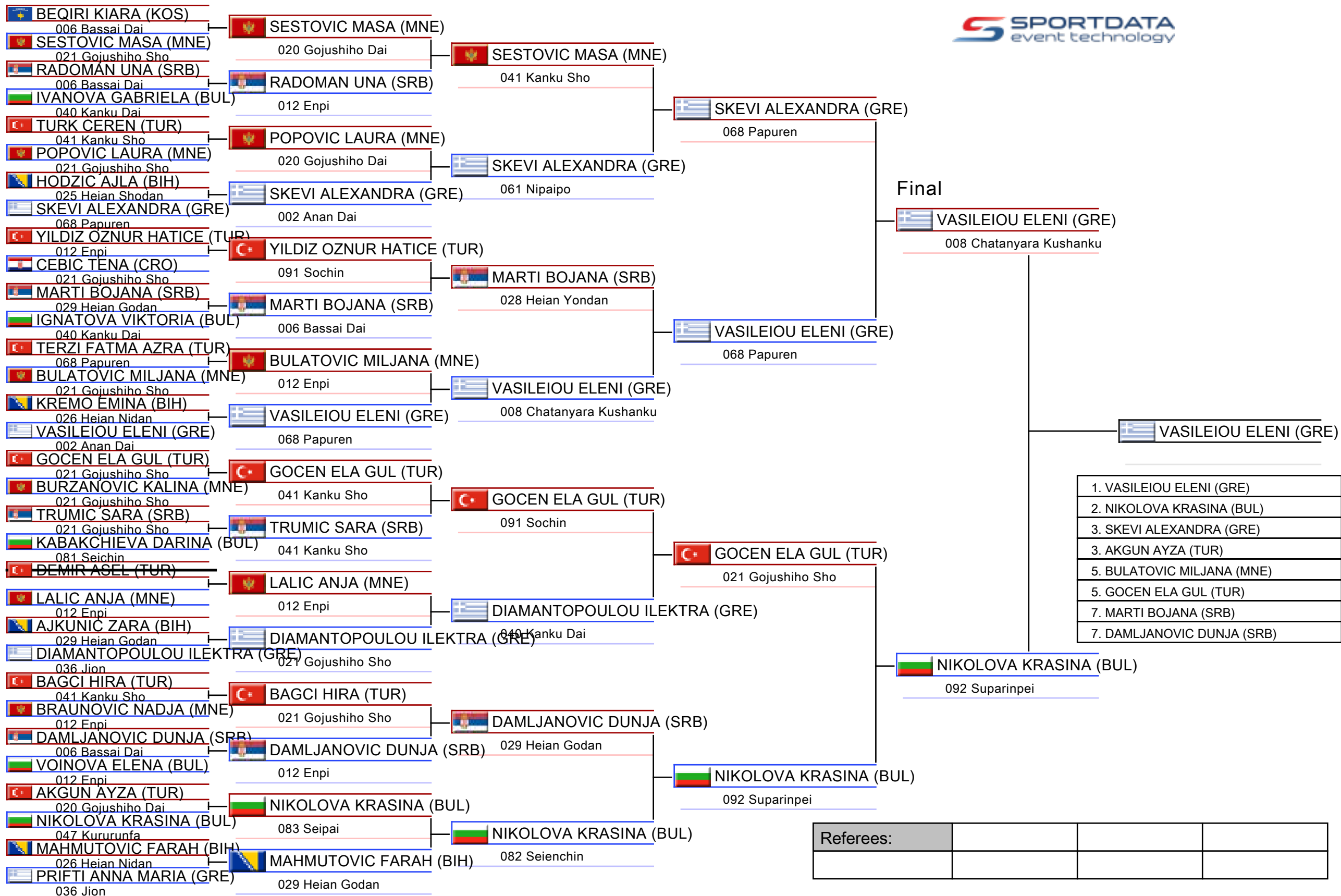

9 Yrs Kata Individual Female

30th Balkan Karate Championships for Children 2026 - Istanbul

2026-05-30

Tatami
5 11:30

Pool
1

(c)sportdata GmbH & Co KG 2000-2026 (2026-05-31 14:45) v 12.2.0 build 1 (2026-05-24 19:07 CET) License: Lazar Piper SRB (expire 2027-01-23)

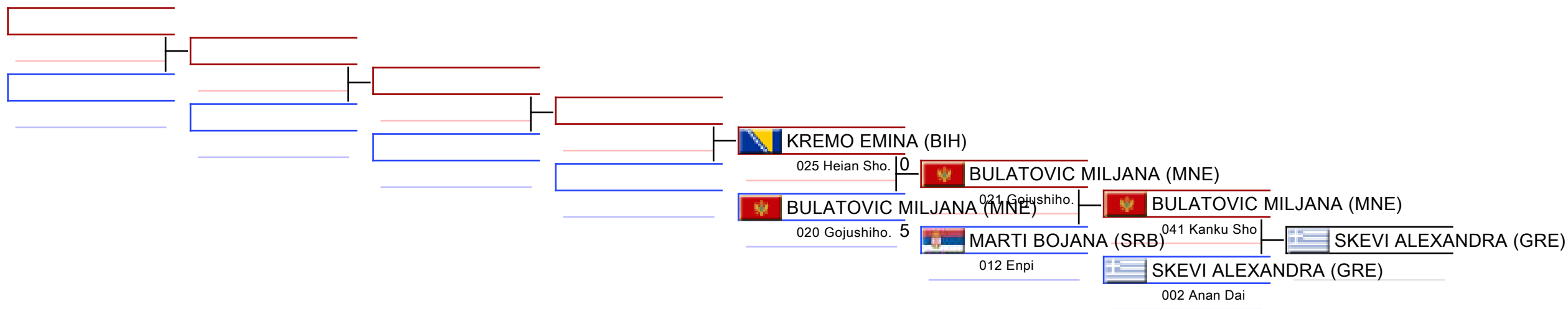

REPECHAGE: (1)



Referees:							
-----------	--	--	--	--	--	--	--

9 Yrs Kata Individual Male

30th Balkan Karate Championships for Children 2026 - Istanbul, Basaksehir Spor Hall, Kayabaşı, TINAZTEPE CADDESİ NO:6, 34494 Başakşehir, İstanbul, TUR2026-05-29

Tatami

5 09:00

Pool

1/2

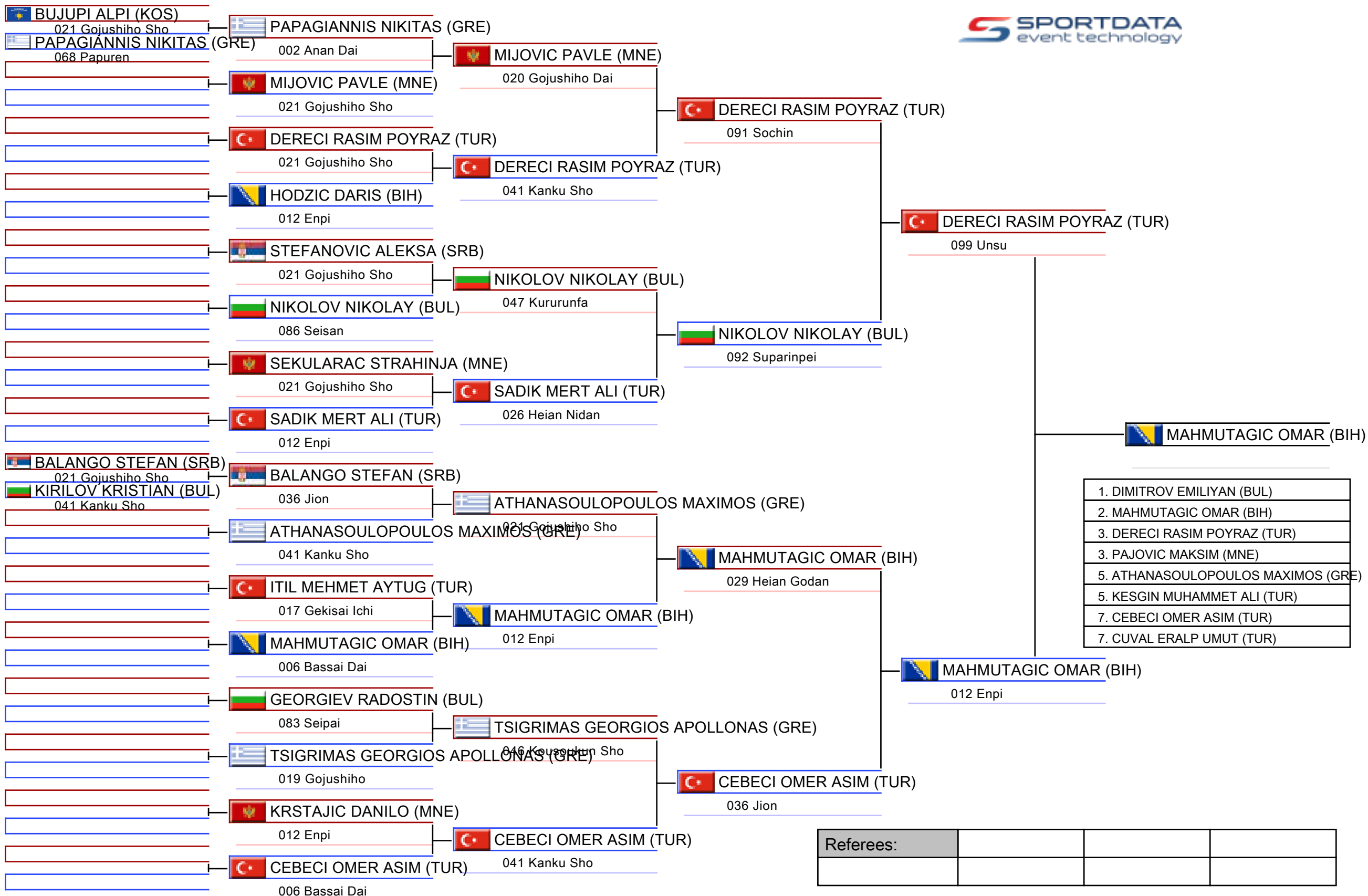

1. DIMITROV EMILIJAN (BUL)
2. MAHMUTAGIC OMAR (BIH)
3. DERECE RASIM POYRAZ (TUR)
3. PAJOVIC MAKSIM (MNE)
5. ATHANASOULOPOULOS MAXIMOS (GRE)
5. KESGIN MUHAMMET ALI (TUR)
7. CEBECE OMER ASIM (TUR)
7. CUVAL ERALP UMUT (TUR)

Pool winner-9 Yrs Kata Individual Male

30th Balkan Karate Championships for Children 2026 - Istanbul, Basaksehir Spor Hall, Kayabaşı, TINAZTEPE CADDESİ NO:6, 34494 Başakşehir, İstanbul, TUR

Tatami

Pool
1/1



Final

 MAHMUTAGIC OMAR (BIH)

021 Gojushiho Sho

 DIMITROV EMILIYAN (BUL)

 DIMITROV EMILIYAN (BUL)

092 Suparinpei

- | |
|------------------------------------|
| 1. DIMITROV EMILIYAN (BUL) |
| 2. MAHMUTAGIC OMAR (BIH) |
| 3. DERECI RASIM POYRAZ (TUR) |
| 3. PAJOVIC MAKSIM (MNE) |
| 5. ATHANASOULOPOULOS MAXIMOS (GRE) |
| 5. KESGIN MUHAMMET ALI (TUR) |
| 7. CEBECI OMER ASIM (TUR) |
| 7. CUVAL ERALP UMUT (TUR) |

Referees:			

9 Yrs Kata Individual Male

30th Balkan Karate Championships for Children 2026 - Istanbul

2026-05-29

Tatami
5 11:50

Pool
1,2

(c)sportdata GmbH & Co KG 2000-2026 (2026-05-31 14:45) v 12.2.0 build 1 (2026-05-24 19:07 CET) License: Lazar Piper SRB (expire 2027-01-23)

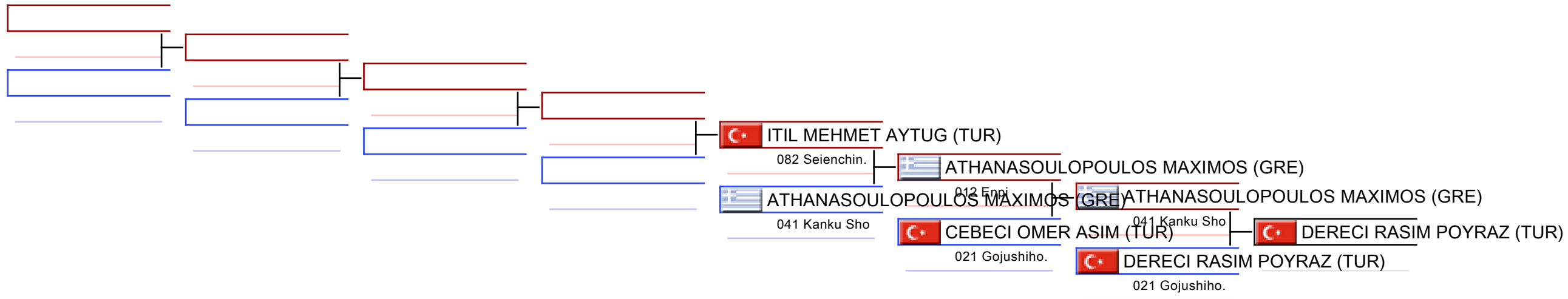

REPECHAGE: (1,2)

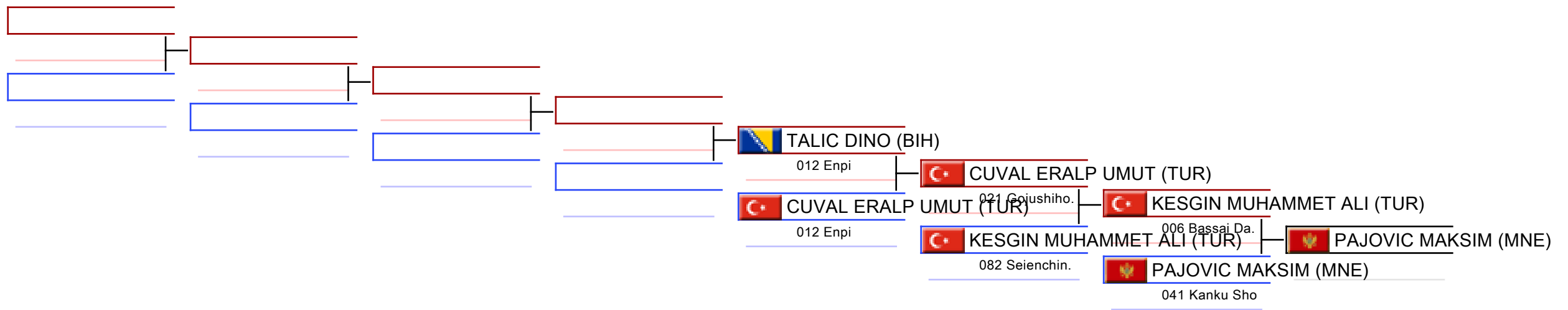

Referees:							
-----------	--	--	--	--	--	--	--



OFFICIAL RESULTS

30th Balkan Karate Championships for
Children 2026 - Istanbul - 2026-05-29

Official Results

10 Yrs Kata Individual Female			
1	RISTOV ISIDORA		SRB - SERBIA
2	LAMPRAKI PANAGIOTA		GRE - GREECE
3	SARAYDAR ESLEM MEVA		TUR - TURKIYE
3	UROSEVIC NIKOLINA		SRB - SERBIA
5	ISIK ERVA NUR		TUR - TURKIYE
5	JANCIC JANA		MNE - MONTENEGRO
7	DJORDJEVIC MIA		SRB - SERBIA
7	RADUNOVIC NINA		MNE - MONTENEGRO
9	KIRILOVA VELIZARA		BUL - BULGARIA
9	CAPRAZ BELINAY		TUR - TURKIYE
11	RADEVA VICTORIA		BUL - BULGARIA



10 Yrs Kata Individual Male			
1	VUCETIC TODOR		SRB - SERBIA
2	VUKMARKOVIC VIKTOR		MNE - MONTENEGRO
3	STERTSOS VASILEIOS		GRE - GREECE
3	AHMETAGIC IMRAN		BIH - BOSNIA AND HERZEGOVINA
5	YIRCALI OMER		TUR - TURKIYE
5	POLOVIC MARKO		MNE - MONTENEGRO
7	NACHEV VLADIMIR		BUL - BULGARIA
7	BABENOV HRISTOMIR		BUL - BULGARIA
9	SAVANOVIC ANDRIJA		BIH - BOSNIA AND HERZEGOVINA
9	PROFIROIU MATEI STEFAN		ROU - ROMANIA

10 Yrs Kumite Female -30 kg			
1	NENEZIC TEODORA		MNE - MONTENEGRO
2	PROSJANOVIC SAJRA		BIH - BOSNIA AND HERZEGOVINA
3	CIHAN ELIF ZUMRA		TUR - TURKIYE
3	ATAGUL ZEYNEP		TUR - TURKIYE
5	KYURKCHIEVA KALINA		BUL - BULGARIA
5	SENGOZ EDA		TUR - TURKIYE
7	SULAJ JEHONA		ALB - ALBANIA
7	ISTRATE CAMELIA		ROU - ROMANIA
9	KATELIEVA SOFIA		BUL - BULGARIA
9	MALICEVIC AJSA		BIH - BOSNIA AND HERZEGOVINA

10 Yrs Kumite Female -34 kg			
1	CECEN HILAL ESLEM		TUR - TURKIYE
2	LAFCI SINA		TUR - TURKIYE
3	YETKIN ELIF		TUR - TURKIYE
3	GALANI MARIA ALEKSANDRA		GRE - GREECE
5	RADOSAVLJEVIC SOFIJA		MNE - MONTENEGRO
5	AKMAZ DERIN		TUR - TURKIYE
7	CHELES ANDREEA		ROU - ROMANIA
7	VURAL EFLIN ERVA		TUR - TURKIYE

30th Balkan Karate Championships for
Children 2026 - Istanbul - 2026-05-29

Official Results

9	RISTIC JANA		SRB - SERBIA	
9	KARIC NEJLA		BIH - BOSNIA AND HERZEGOVINA	

10 Yrs Kumite Female -37 kg

1	MUJKIC SAJRA		BIH - BOSNIA AND HERZEGOVINA	
2	CEVIK NIDANUR		TUR - TURKIYE	
3	OSMAJIC SOFIJA		MNE - MONTENEGRO	
3	HODZIC DELILA		BIH - BOSNIA AND HERZEGOVINA	
5	HELVACI ELIF		TUR - TURKIYE	
5	IBRANOVIC AMINA		BIH - BOSNIA AND HERZEGOVINA	
7	SARAYDAR ESLEM MEVA		TUR - TURKIYE	
7	KOVACIC LUCIA		CRO - CROATIA	
9	PUZOVIC LANA		SRB - SERBIA	

10 Yrs Kumite Female -40 kg

1	OREK HIRANUR		TUR - TURKIYE	
2	GENC SELIN		TUR - TURKIYE	
3	JEVDJEVIC LAURA		MNE - MONTENEGRO	
3	MARAS MATEA		MNE - MONTENEGRO	
5	LUGONJA EMILIJA		BIH - BOSNIA AND HERZEGOVINA	
5	MESIC LANA		CRO - CROATIA	
7	BJEKOVIC TARA		SRB - SERBIA	
7	MUMINOVIC MIRNA		BIH - BOSNIA AND HERZEGOVINA	

10 Yrs Kumite Female 40+ kg

1	TSIOTA MELINA		GRE - GREECE	
2	HEROLD ANA		CRO - CROATIA	
3	TOMAK ZEYNEP OYKU		TUR - TURKIYE	
3	VUJIN ANDJELIJA		BIH - BOSNIA AND HERZEGOVINA	
5	YALNIZOGLU RABIA TUGBA		TUR - TURKIYE	
5	SIVRI YAGMUR SILA		TUR - TURKIYE	
7	DURAK DEFNE		TUR - TURKIYE	
7	GUNER IRMAK		TUR - TURKIYE	
9	KAVURIN SARA		SRB - SERBIA	

10 Yrs Kumite Male -30 kg

1	BUBANJA BORIS		MNE - MONTENEGRO	
2	DUNDERER OGUZ KAAAN		TUR - TURKIYE	
3	PANIC ISAK		BIH - BOSNIA AND HERZEGOVINA	
3	ODEMIS MUSTAFA SAMIL		TUR - TURKIYE	
5	TOMLJANOVIC ERIK		CRO - CROATIA	
5	DRODU EDUARD MARIAN		ROU - ROMANIA	
7	VASIC NEMANJA		BIH - BOSNIA AND HERZEGOVINA	
7	TURKER DERIN		TUR - TURKIYE	
9	MICETA FILIP		MNE - MONTENEGRO	
9	KOUROUPIS DIMOS		GRE - GREECE	

30th Balkan Karate Championships for
Children 2026 - Istanbul - 2026-05-29

Official Results

10 Yrs Kumite Male -35 kg			
1	CAN MUSTAFA		TUR - TURKIYE
2	BAYAR CAYAN ATEŞ		TUR - TURKIYE
3	GORDIC BOGDAN		BIH - BOSNIA AND HERZEGOVINA
3	TIHAK ARMAN		BIH - BOSNIA AND HERZEGOVINA
5	AYYILDIZ POYRAZ		TUR - TURKIYE
5	GEORGIEV GEORGI		BUL - BULGARIA
7	BABIC MIHAİLO		BIH - BOSNIA AND HERZEGOVINA
7	CINAR YUNUS EMRE		TUR - TURKIYE
9	GRAVALOS EFTHYMİOS		GRE - GREECE
9	MUHIC ARMEND		BIH - BOSNIA AND HERZEGOVINA

10 Yrs Kumite Male -40 kg			
1	PAPAZIS EMMANOUIL		GRE - GREECE
2	GURCAN ALPKAN		TUR - TURKIYE
3	KARAALI POYRAZ ATEŞ		TUR - TURKIYE
3	MIU RARES		ROU - ROMANIA
5	PARASKEVAS MARIOS		GRE - GREECE
5	MUJKANOVIC HARUN		BIH - BOSNIA AND HERZEGOVINA
7	KUTUCU SELİM ERDOĞAN		TUR - TURKIYE
7	TUNC ALI TAHA		TUR - TURKIYE

10 Yrs Kumite Male -45 kg			
1	AKYUZ DURSUN BERAT		TUR - TURKIYE
2	ALEKSOVSKI STEFAN		MKD - NORTH MACEDONIA
3	ALP ALP TİGIN		TUR - TURKIYE
3	BOYADZHIEV STEFAN		BUL - BULGARIA
5	ZJAKIC HARUN		BIH - BOSNIA AND HERZEGOVINA
5	OZ METEHAN		TUR - TURKIYE
7	GKIONIS EVANGELOS		GRE - GREECE
7	ZIVKOVIC MILUTIN		SRB - SERBIA

10 Yrs Kumite Male 45+ kg			
1	RADOVIC RELJA		SRB - SERBIA
2	KIRBAS MERT		TUR - TURKIYE
3	REMZI SINAN		BUL - BULGARIA
3	İLİNCİC LUKA		MNE - MONTENEGRO
5	YILMAZ PAMİR TANBEY		TUR - TURKIYE
5	DAVITKOV DUSAN		SRB - SERBIA
7	KRUNIC TADIJA		SRB - SERBIA
7	KARGI ERDEM		TUR - TURKIYE

10-11 Yrs Kata Team Female			
1	TURKIYE		TUR - TURKIYE

30th Balkan Karate Championships for
Children 2026 - Istanbul - 2026-05-29



Official Results

	- ALTINTAS ZEYNEP - KARADAG ZEYNEP - SANDAL ZEYNEP SARE - YORGUN MASAL			
2	GREECE - LAMPRAKI PANAGIOTA - PAPACHRISTOU EVGENIA - PILATOU DIMITRA		GRE - GREECE	
3	MONTENEGRO - JANCIC JANA - RADULOVIC ANJA - RASPOPOVIC GLORIJA - SHABANOVIQ IRSI		MNE - MONTENEGRO	
3	TURKIYE - CAPRAZ BELINAY - GUNDUZ RABIA ECEM - KAVAS BUGLEM - SARAYDAR ESLEM MEVA		TUR - TURKIYE	
5	SERBIA - JOVANOVIC MASA - MANOJLOVIC TIJANA - MIRIC DANKA		SRB - SERBIA	
5	MONTENEGRO - BOSKOVIC MONA - BULATOVIC NADJA - DJURICIC ANJA		MNE - MONTENEGRO	

10-11 Yrs Kata Team Male

1	TURKIYE - OZKANOGLU CINAR ALP - ULUTURK NECATI YUCEL - YILDIRIM KEREM ASLAN - YILMAZ KADIR MERT		TUR - TURKIYE	
2	TURKIYE - AKSOY METEHAN - BARKOL AYBARS UFUK - KIZILYAR ALI		TUR - TURKIYE	
3	MONTENEGRO - DROBNJAK LUKA - ILINCIC LUKA - TOMIC VASILIJJE - TOSIC TEODOR		MNE - MONTENEGRO	
3	MONTENEGRO - DRACA IVAN - OPACINA ANDRIJA - POLOVIC MARKO - VUKMARKOVIC VIKTOR		MNE - MONTENEGRO	
5	Macedonia - MANTAROSKI GORAZD - JANESKI DIMITAR - GJURIKJ SERGEJ - MOMIROSKI FILIP		MKD - NORTH MACEDONIA	
5	BULGARIA - IVANOV IVAN - NACHEV VLADIMIR - TOMOV GEORGY		BUL - BULGARIA	

11 Yrs Kata Individual Female

1	SKRBIC SARA		SRB - SERBIA	
2	ILIC SOFIJA		BIH - BOSNIA AND HERZEGOVINA	

30th Balkan Karate Championships for
Children 2026 - Istanbul - 2026-05-29

Official Results

3	GULEN ECRIN		TUR - TURKIYE	
3	RADULOVIC ANJA		MNE - MONTENEGRO	
5	UZUNESER MIHRINUR		TUR - TURKIYE	
5	PAPACHRISTOU EVGENIA		GRE - GREECE	
7	SHABANOVIQ IRSI		MNE - MONTENEGRO	
7	MUTLUOGLU RABIA		TUR - TURKIYE	
9	TZEDAKI MARIA		GRE - GREECE	
9	PARASCHIV MAYA ELENA		ROU - ROMANIA	

11 Yrs Kata Individual Male

1	SONMEZ ISMAIL HAKKI		TUR - TURKIYE	
2	AKBAS MUSTAFA SAID		TUR - TURKIYE	
3	ILINCIC LUKA		MNE - MONTENEGRO	
3	TSVYATKOV NIKOLAY		BUL - BULGARIA	
5	DAVCHEV JORDAN		MKD - NORTH MACEDONIA	
5	JASAREVIC NAZIF		BIH - BOSNIA AND HERZEGOVINA	
7	VLAD ANDREI JUSTINIAN		ROU - ROMANIA	
7	AKDENIZ SELIM EGE		TUR - TURKIYE	
9	TOMOV GEORGY		BUL - BULGARIA	
9	DIMOPOULOS DIMITRIOS		GRE - GREECE	

11 Yrs Kumite Female -32 kg

1	KRIVOKAPIC MIA		MNE - MONTENEGRO	
2	OZDEMIR SEMA NUR		TUR - TURKIYE	
3	BESIKCI ELIF GOKCE		TUR - TURKIYE	
3	EZEL ELA NUR		TUR - TURKIYE	
5	GASHI MARTINA		KOS - KOSOVO	
5	YAVUZ AYSEGUL		TUR - TURKIYE	
7	BASIC ZARA		CRO - CROATIA	
7	SPASOVA KATERINA		BUL - BULGARIA	
9	ADILOVIC DZEJNA		BIH - BOSNIA AND HERZEGOVINA	

11 Yrs Kumite Female -36 kg

1	LIVNJAK IMAN		BIH - BOSNIA AND HERZEGOVINA	
2	AZAK ELIF TUBA		TUR - TURKIYE	
3	PAPACHRISTOU EVGENIA		GRE - GREECE	
3	YILDIRIM HIRANUR		TUR - TURKIYE	
5	BROUZAKI MARIA		GRE - GREECE	
5	TODOROVIC MASA		MNE - MONTENEGRO	
7	STEFAN DIANA		ROU - ROMANIA	
7	PILATOU DIMITRA		GRE - GREECE	
9	CHARALAMPAKI GARYFALLIA ARIADNI		GRE - GREECE	

11 Yrs Kumite Female -40 kg

1	PETROVIC LJUBICA		SRB - SERBIA	
2	SUSIC SARA		BIH - BOSNIA AND HERZEGOVINA	
3	DEMIRCI MEDINE MERVE		TUR - TURKIYE	

30th Balkan Karate Championships for
Children 2026 - Istanbul - 2026-05-29

Official Results

3	DAMJANOVIC NIKOLINA		MNE - MONTENEGRO	
5	OZTURK INCI		TUR - TURKIYE	
5	BOYADZHIEVA BORISA		BUL - BULGARIA	
7	MUHIC IMAN		BIH - BOSNIA AND HERZEGOVINA	
7	LUKIC NINA		SRB - SERBIA	
9	ZDRAVKOVA KRISTINA		BUL - BULGARIA	
9	ONALAN BERCEM		TUR - TURKIYE	

11 Yrs Kumite Female -44 kg

1	YILDIZ ADA SU		TUR - TURKIYE	
2	RAJKOVIC ANA		BIH - BOSNIA AND HERZEGOVINA	
3	IMSIROVIC SARA		BIH - BOSNIA AND HERZEGOVINA	
3	RADINOVIC STASA		MNE - MONTENEGRO	
5	VOJINOVIC LENA		SRB - SERBIA	
5	YILMAZ AFRA		TUR - TURKIYE	
7	BUDAKER SIBEL		TUR - TURKIYE	
7	KARACHALIOU PANAGIOTA		GRE - GREECE	
9	JOVIC MILA		SRB - SERBIA	

11 Yrs Kumite Female 44+ kg

1	RADIC BOZANA		BIH - BOSNIA AND HERZEGOVINA	
2	ZEKOVIC AISA		BIH - BOSNIA AND HERZEGOVINA	
3	AKPUNAR BEGUM		TUR - TURKIYE	
3	YILMAZ NILDA OYKU		TUR - TURKIYE	
5	ZIOGOU AIKATERINI		GRE - GREECE	
5	RANKOVIC SOFIJA		SRB - SERBIA	
7	RALIC ISKRA		MNE - MONTENEGRO	
7	RISTOVA LANA		MKD - NORTH MACEDONIA	
9	VELENTZA MARIA IOANNA		GRE - GREECE	
9	BRNADIC MARA		CRO - CROATIA	

11 Yrs Kumite Male -35 kg

1	KAYA ISMAIL CUNEYT		TUR - TURKIYE	
2	DEREBAGI OMER EYMEN		TUR - TURKIYE	
3	AKCAY OMER		TUR - TURKIYE	
3	TEKE MUHAMMED BILAL		TUR - TURKIYE	
5	MAKRIS PANAGIOTIS		GRE - GREECE	
5	PETROVSKI ALEKSANDAR		MKD - NORTH MACEDONIA	
7	DOJCINOVIC MILAN		BIH - BOSNIA AND HERZEGOVINA	
7	MUSAT DARIUS		ROU - ROMANIA	
9	JOVANOVIC STRAHINJA		SRB - SERBIA	
9	RADULOVIC MIHAILO		SRB - SERBIA	

11 Yrs Kumite Male -40 kg

1	PAYLI SIYAR		TUR - TURKIYE	
2	SONMEZ ISMAIL HAKKI		TUR - TURKIYE	
3	KOZIC PAVEL		CRO - CROATIA	

30th Balkan Karate Championships for
Children 2026 - Istanbul - 2026-05-29

Official Results

3	CRNKOVIC BORNA		CRO - CROATIA	
5	DIMITROV KONSTANTIN		BUL - BULGARIA	
5	RAJILIC FILIP		BIH - BOSNIA AND HERZEGOVINA	
7	BOULIARIS PARASKEVAS		GRE - GREECE	
7	KAROUNIS KONSTANTINOS		GRE - GREECE	
9	PASALAU VLAD		ROU - ROMANIA	
9	MIJATOVIC MAKSIM		SRB - SERBIA	

11 Yrs Kumite Male -45 kg

1	KAYA ENES ARDA		TUR - TURKIYE	
2	FILIPOVIC ANTE		CRO - CROATIA	
3	BJELANOVIC ALEKSA		MNE - MONTENEGRO	
3	SAVAS MUHAMMET		TUR - TURKIYE	
5	CEBIC NEMANJA		SRB - SERBIA	
5	ZIVKOVIC ALJOSA		SRB - SERBIA	
7	CANI LUIS		ALB - ALBANIA	
7	TOKIC AHMED		BIH - BOSNIA AND HERZEGOVINA	
9	SKOURMPOUTIS DAMIANOS		GRE - GREECE	
9	VUKOVIC VIKTOR		MNE - MONTENEGRO	

11 Yrs Kumite Male -50 kg

1	LAZIC PAVLE		MNE - MONTENEGRO	
2	BUKVA HARUN		BIH - BOSNIA AND HERZEGOVINA	
3	KURNAZ MUSAB YAGIZ		TUR - TURKIYE	
3	TOMIC JOVAN		SRB - SERBIA	
5	KILINC AHMET		TUR - TURKIYE	
5	JURAGA DANI		CRO - CROATIA	
7	JOKIC ADRIJAN		BIH - BOSNIA AND HERZEGOVINA	
7	MUSTAFA AULON		MKD - NORTH MACEDONIA	

11 Yrs Kumite Male 50+ kg

1	PEKTAS EYMEN		TUR - TURKIYE	
2	AKELJIC HAMZA		BIH - BOSNIA AND HERZEGOVINA	
3	MLADENOVIC NIKOLA		SRB - SERBIA	
3	UCAK GOKALP		TUR - TURKIYE	
5	VACHEV GEORGI		BUL - BULGARIA	
5	SKRIJELJ EROL		MNE - MONTENEGRO	
7	SINANI ANAID		ALB - ALBANIA	
7	DJURDJEVIC VELJKO		BIH - BOSNIA AND HERZEGOVINA	
9	VUJOVIC PAVLE		SRB - SERBIA	

12 Yrs Kata Individual Female

1	BODROZIC ALEKSANDRA		SRB - SERBIA	
2	PAVLOVIC ANA		MNE - MONTENEGRO	
3	DRACA LANA		MNE - MONTENEGRO	
3	KAPLAN ZEYNEP		TUR - TURKIYE	
5	GUNDOGDU ZEYNEB NUR		TUR - TURKIYE	

30th Balkan Karate Championships for
Children 2026 - Istanbul - 2026-05-29

Official Results

5	KOZAK FATMA NUR		TUR - TURKIYE	
7	ADILOVIC ZAHRA		BIH - BOSNIA AND HERZEGOVINA	
7	TURAN ASYA MASAL		TUR - TURKIYE	
9	DIONYSOPOULOU ARCHONTIA		GRE - GREECE	
9	FLOREA DARIA		ROU - ROMANIA	
11	BULATOVIC MIA		MNE - MONTENEGRO	
11	CORDASIC ELENA		SRB - SERBIA	

12 Yrs Kata Individual Male

1	NIKIFOROS MICHAIL		GRE - GREECE	
2	CEVIK YUCEL		TUR - TURKIYE	
3	GUDER MUSTAFA EREN		TUR - TURKIYE	
3	EFE ER OZEN EGEMEN		TUR - TURKIYE	
5	TAS ALPEREN		TUR - TURKIYE	
5	YAGCI GOKBAY		TUR - TURKIYE	
7	RADIVOJEVIC UROS		SRB - SERBIA	
7	SARITOPRAK MEHMET		TUR - TURKIYE	
9	GRAMMATIKOS CHRISTOS GIANNOS		GRE - GREECE	
9	TATAREVIC DAVUD		BIH - BOSNIA AND HERZEGOVINA	

12 Yrs Kumite Female -35 kg

1	GRBOVIC ITANA		MNE - MONTENEGRO	
2	RADULOVIC SOFIJA		MNE - MONTENEGRO	
3	VRAILA ANGELIKI		GRE - GREECE	
3	HIDIC NASIHA		BIH - BOSNIA AND HERZEGOVINA	
5	HIDIC EJNA		BIH - BOSNIA AND HERZEGOVINA	
5	HODZIC IMAN		BIH - BOSNIA AND HERZEGOVINA	
7	STAMPOLI KONSTANTINA		GRE - GREECE	
7	HAMURCU ZEYNEP		TUR - TURKIYE	
9	JERAT ELLA		CRO - CROATIA	
9	ZAGRAN ANGELINA		BIH - BOSNIA AND HERZEGOVINA	

12 Yrs Kumite Female -40 kg

1	JOVANOVIC SARA		SRB - SERBIA	
2	HODZIC LAJLA		BIH - BOSNIA AND HERZEGOVINA	
3	DJUROVIC ANDJELA		MNE - MONTENEGRO	
3	OGNJAN ANASTASIJA		SRB - SERBIA	
5	NESIC ISKRA		SRB - SERBIA	
5	ISIK AYSE BETUL		TUR - TURKIYE	
7	YILMAZ BEYZANUR		TUR - TURKIYE	
7	KAYA EYLUL CEREN		TUR - TURKIYE	
9	GLINESCHE RAYSSA		ROU - ROMANIA	
9	VELKOVSKA KAJA		MKD - NORTH MACEDONIA	
11	VASTARDI AMALIA		GRE - GREECE	

12 Yrs Kumite Female -45 kg

1	DUNIC NIKA		CRO - CROATIA	
---	------------	---	---------------	--

30th Balkan Karate Championships for
Children 2026 - Istanbul - 2026-05-29

Official Results

2	DEVRNJA MILENA		SRB - SERBIA	
3	YAMAN SUMEYRA		TUR - TURKIYE	
3	VUJOSEVIC TEODORA		MNE - MONTENEGRO	
5	SIR KEVSER		TUR - TURKIYE	
5	ALEKSIC OLGA		MNE - MONTENEGRO	
7	DONDAR DEFNE		TUR - TURKIYE	
7	URAY RABIASU		TUR - TURKIYE	
9	KRASTEVA TSVETELINA		BUL - BULGARIA	
9	GEROKONSTANTI MYRTO PANAGIOTA		GRE - GREECE	

12 Yrs Kumite Female -50 kg

1	EZEL EYLUL		TUR - TURKIYE	
2	DJONBALJAJ ASIJA		MNE - MONTENEGRO	
3	ILIEVSKA DORA		MKD - NORTH MACEDONIA	
3	CIVAK FEYZA		TUR - TURKIYE	
5	LISICIC KATARINA		MNE - MONTENEGRO	
5	NIKOLIC ANDREA		SRB - SERBIA	
7	GRUJIC LENKA		SRB - SERBIA	
7	HRUSTANOVIC MERJEM		BIH - BOSNIA AND HERZEGOVINA	
9	HALILOVIC NEJRA		BIH - BOSNIA AND HERZEGOVINA	
9	LOKI ERINA		MKD - NORTH MACEDONIA	

12 Yrs Kumite Female 50+ kg

1	IYISEN YAGMUR		TUR - TURKIYE	
2	URAN MELIS		TUR - TURKIYE	
3	TOKLU MIRAY NUR		TUR - TURKIYE	
3	SESTAK DALIA		CRO - CROATIA	
5	KOTSIKONA ATHANASIA MARIA		GRE - GREECE	
5	MANGIC NEJLA		BIH - BOSNIA AND HERZEGOVINA	
7	KORJENIC AJLA		BIH - BOSNIA AND HERZEGOVINA	
7	TAHIROVIC AMINA		BIH - BOSNIA AND HERZEGOVINA	
9	TEMKOVA ANGELA		MKD - NORTH MACEDONIA	

12 Yrs Kumite Male -37 kg

1	MIKULIC PETAR		MNE - MONTENEGRO	
2	KASCELAN PAVLE		MNE - MONTENEGRO	
3	STANOJEVIC DIMITRIJE		SRB - SERBIA	
3	SAKOVIC FILIP		MNE - MONTENEGRO	
5	HYSENI OMER		KOS - KOSOVO	
5	BARJAKTAROVIC MATIJA		MNE - MONTENEGRO	
7	HASANI SIVEN		ALB - ALBANIA	
7	YALIM EREN DORUK		TUR - TURKIYE	
9	SILJ PAVLE		BIH - BOSNIA AND HERZEGOVINA	
9	ZALDANA LORENZO AARON		CRO - CROATIA	

12 Yrs Kumite Male -42 kg

1	RIBAR TOMA		CRO - CROATIA	
---	------------	---	---------------	--

30th Balkan Karate Championships for
Children 2026 - Istanbul - 2026-05-29

Official Results

2	NEZIRI EBUBEKR		MKD - NORTH MACEDONIA	
3	DINLER GUNEY BAYRAM		TUR - TURKIYE	
3	BAYRAKTAR HALIT KAAAN		TUR - TURKIYE	
5	ZILIC KERIM		BIH - BOSNIA AND HERZEGOVINA	
5	TASKIN EREN		TUR - TURKIYE	
7	CELIK ALI EMIR		TUR - TURKIYE	
7	MEMOVIC VEDAD		BIH - BOSNIA AND HERZEGOVINA	
9	BOZIC TADIJA		SRB - SERBIA	
9	KAFARATZIS CHRISTOS		GRE - GREECE	

12 Yrs Kumite Male -47 kg				
1	MARINOVIC JAKSA		MNE - MONTENEGRO	
2	ZEQIRAJ RRON		KOS - KOSOVO	
3	BAKOLAS IOANNIS		GRE - GREECE	
3	JANKOVIC MILOVAN		MNE - MONTENEGRO	
5	GUNGORMUS EFE		TUR - TURKIYE	
5	KAZANCIOGLU OMER MAHMUT		TUR - TURKIYE	
7	VLAD DIMITRIE TRAIAN		ROU - ROMANIA	
7	MIKIC TODOR		SRB - SERBIA	
9	ILINCIC ALEKSEJ		MNE - MONTENEGRO	

12 Yrs Kumite Male -52 kg				
1	KALOPER MUHAMED		BIH - BOSNIA AND HERZEGOVINA	
2	BARBARIC ANTE		CRO - CROATIA	
3	SKORIC ANDREJ		BIH - BOSNIA AND HERZEGOVINA	
3	RADOICIC ALEKSA		SRB - SERBIA	
5	NIKOLOV STANISLAV		BUL - BULGARIA	
5	ZEFI DED		GRE - GREECE	
7	JANEVSKI DAMJAN		MKD - NORTH MACEDONIA	
7	KOSEOGLU SELIM EMRE		TUR - TURKIYE	
9	TASAR AYZ		TUR - TURKIYE	
9	UNAL UTKU TAHA		TUR - TURKIYE	

12 Yrs Kumite Male 52+ kg				
1	KALINKOV SERGEJ		BIH - BOSNIA AND HERZEGOVINA	
2	BUJIC NJEGOS		BIH - BOSNIA AND HERZEGOVINA	
3	GACESA LUKA		BIH - BOSNIA AND HERZEGOVINA	
3	JOCIC ANDREJ		SRB - SERBIA	
5	TEZCAN IBRAHIM SABRI		TUR - TURKIYE	
5	ICEN MEHMET		TUR - TURKIYE	
7	GOSA OMAR		ALB - ALBANIA	
7	SOUEREF ALEXIOS IOSIF		GRE - GREECE	
9	SAGLAM HAYDAR		TUR - TURKIYE	
9	ZIVANOVIC LAZAR		SRB - SERBIA	

12-13 Yrs Kata Team Female				
1	SERBIA		SRB - SERBIA	

30th Balkan Karate Championships for
Children 2026 - Istanbul - 2026-05-29

Official Results

	- JEVDJENIJEVIC MINJA - MANOJLOVIC SOFIJA - NOVKOVIC ANDJELIJA - PAVLOVIC EMILIJA			
2	MONTENEGRO - BULATOVIC MIA - DJUKOVIC STEFANI - DRACA LANA - PAVLOVIC ANA		MNE - MONTENEGRO	
3	TURKIYE - DARGIN AZRA MELIHA - KUTLUG SADIYAH - SAVAS AYSE SEVDE - TANHAN MERYEM GOKCE		TUR - TURKIYE	
3	TURKIYE - KOZAK FATMA NUR - ASLAN GULSER - ALABAS NISA - TURKMEN HILAL		TUR - TURKIYE	
5	BULGARIA - DJAMIL SOFYIA - DOLENSKA NIYA - YANKOVA ZORNITSA		BUL - BULGARIA	
5	MONTENEGRO - HODZIC NADILA - PAVLICIC ANDREA - VODOPIC ZAJNEBA - BOSKOVIC LUNA		MNE - MONTENEGRO	

12-13 Yrs Kata Team Male

1	TURKIYE - AVINCSAL ZINAR DEVRAN - BALCI ASLAN - BIYIKLI ATA - EREN ENVER ALP		TUR - TURKIYE	
2	TURKIYE - AKGUN TAYLAN EGE - CINAR YAGIZ MIRAC - SARITOPRAK MEHMET - YUKSEL ERTUGRUL		TUR - TURKIYE	
3	MONTENEGRO - CUPARA JAKOV - PEROVIC BORIS - POPOVIC LAZAR - SELLOVIQ UZEJR		MNE - MONTENEGRO	
3	SERBIA - ARSIC FILIP - KOVACEVIC OGNJEN - MIJATOVIC LAZAR		SRB - SERBIA	
5	Macedonia - ILIEVSKI IVAN - JOVANOV ALEKSANDAR - TRENDAFILOV VASILIJ		MKD - NORTH MACEDONIA	
5	MONTENEGRO - BARJAKTAROVIC ANDRIJA - LEKOVIC BALSAA - MILOSEVIC MATIJA - VUKMARKOVIC DAVID		MNE - MONTENEGRO	

13 Yrs Kata Individual Female

1	BRACIC ISIDORA		MNE - MONTENEGRO	
---	----------------	---	------------------	--

30th Balkan Karate Championships for
Children 2026 - Istanbul - 2026-05-29

Official Results

2	MOMCILOVIC UNA		SRB - SERBIA	
3	CAKIR PERVIN		TUR - TURKIYE	
3	NOVKOVIC ANDJELIJA		SRB - SERBIA	
5	OZ ECRIN		TUR - TURKIYE	
5	BEREZNI DUNJA		SRB - SERBIA	
7	PAPADOPOULOU SOFIA		GRE - GREECE	
7	MAJKIC UNA		SRB - SERBIA	
9	DOLENSKA NIYA		BUL - BULGARIA	
9	CHELES ANTONIA		ROU - ROMANIA	
11	YANKOVA ZORNITSA		BUL - BULGARIA	

13 Yrs Kata Individual Male

1	BARJAKTAROVIC ANDRIJA		MNE - MONTENEGRO	
2	KOC ABDULKADIR		TUR - TURKIYE	
3	CESAR JAN		CRO - CROATIA	
3	KARAGOZ ZEYNEL		TUR - TURKIYE	
5	AVINCSAL ZINAR DEVRAN		TUR - TURKIYE	
5	POPOVIC LAZAR		MNE - MONTENEGRO	
7	RADMILOVIC MILAN		SRB - SERBIA	
7	MOURATIDIS IOANNIS		GRE - GREECE	
9	HASAJ OLTİ		KOS - KOSOVO	
9	KOVACEVIC OGNJEN		SRB - SERBIA	
11	JOVANOVA ALEKSANDAR		MKD - NORTH MACEDONIA	

13 Yrs Kumite Female -39 kg



1	KASUMOVIC MERJEM		BIH - BOSNIA AND HERZEGOVINA	
2	AFSIN ECRIN YAREN		TUR - TURKIYE	
3	ZAFIROVIC LENA		SRB - SERBIA	
3	SUSIC HANA		BIH - BOSNIA AND HERZEGOVINA	
5	SIMSEK NESIBENUR		TUR - TURKIYE	
5	STEPANOVIC LENA		SRB - SERBIA	
7	RAKAZOV MILICA		SRB - SERBIA	
7	YUSUF NAILE		TUR - TURKIYE	
9	NISIC NEJRA		BIH - BOSNIA AND HERZEGOVINA	

13 Yrs Kumite Female -44 kg

1	MOHLER KATJA		CRO - CROATIA	
2	CARBAS ESLEM		TUR - TURKIYE	
3	OZKAN TUGSEM		TUR - TURKIYE	
3	PASALIC AJLA		BIH - BOSNIA AND HERZEGOVINA	
5	KABA AYSIMA		TUR - TURKIYE	
5	PAVLOVIC EMILIIA		SRB - SERBIA	
7	GUVENDI DURU		TUR - TURKIYE	
7	EVA TINCU		ROU - ROMANIA	
9	NIKOLINA KILIBARDA		MNE - MONTENEGRO	
9	THEOCHARI IOANNA CHRYSOVALANTI		GRE - GREECE	

30th Balkan Karate Championships for
Children 2026 - Istanbul - 2026-05-29

Official Results

11	KLICIC SELENA		SRB - SERBIA	
11	LENARD GABRIELA		CRO - CROATIA	

13 Yrs Kumite Female -49 kg

1	AYKIN NUR BETUL		TUR - TURKIYE	
2	MURTEZANI ADA		MKD - NORTH MACEDONIA	
3	VITA LOZO MILLA		CRO - CROATIA	
3	SOPHIA ISTRATE		ROU - ROMANIA	
5	JANKOVIC JELENA		MNE - MONTENEGRO	
5	KORDIC MARTA		CRO - CROATIA	
7	KOSTADINOVA ILINA		MKD - NORTH MACEDONIA	
7	CUK JOSIPA		CRO - CROATIA	
9	YANKOVA ZORNITSA		BUL - BULGARIA	
9	DEGIRMENCI OZDE		TUR - TURKIYE	

13 Yrs Kumite Female -54 kg

1	KOSTOVA SIMONA		BUL - BULGARIA	
2	MIRUNA COMAN		ROU - ROMANIA	
3	SOFIA GROSU		ROU - ROMANIA	
3	ELENA DUMIC		MNE - MONTENEGRO	
5	MARICEVIC NEDA		SRB - SERBIA	
5	MUZDEKA JOVANA		SRB - SERBIA	
7	CAKIR PERVIN		TUR - TURKIYE	
7	EMRE ZEYNEP ERVA		TUR - TURKIYE	
9	HUSANOVIC UMA		BIH - BOSNIA AND HERZEGOVINA	
9	KESIDOU ZOI		GRE - GREECE	
11	GOKSEL MIRAC		TUR - TURKIYE	

13 Yrs Kumite Female 54+ kg

1	BESLIJA MEDINA		BIH - BOSNIA AND HERZEGOVINA	
2	COKU DILA		TUR - TURKIYE	
3	BALOG TESA		CRO - CROATIA	
3	PRLJA IRINA		MNE - MONTENEGRO	
5	PREKIC EMINA		MNE - MONTENEGRO	
5	PAVLOVIC TINA		SRB - SERBIA	
7	KUS BEREN		TUR - TURKIYE	
7	MILOSAVLJEVIC BOJANA		SRB - SERBIA	
9	SOURA IOANNA		GRE - GREECE	
9	BOSNJAK MERJEM		BIH - BOSNIA AND HERZEGOVINA	
11	DURAKU HUMEIJRA		MNE - MONTENEGRO	

13 Yrs Kumite Male -40 kg

1	BUNDA AHMED		BIH - BOSNIA AND HERZEGOVINA	
2	KARADAG MUHAMMET ALI		TUR - TURKIYE	
3	PUKLAVEC MISLAV		CRO - CROATIA	
3	BOROJEVIC UROS		SRB - SERBIA	
5	KORDOS LEONIDAS		GRE - GREECE	

30th Balkan Karate Championships for
Children 2026 - Istanbul - 2026-05-29

Official Results

5	OZCELIK ARAS		TUR - TURKIYE	
7	GELMEZ MERT ALI		TUR - TURKIYE	
7	TOMASEVIC VUK		MNE - MONTENEGRO	
9	VOJINOVIC VIKTOR		MNE - MONTENEGRO	
9	MOURATIDIS IOANNIS		GRE - GREECE	

13 Yrs Kumite Male -45 kg

1	SELIMI ISA		MKD - NORTH MACEDONIA	
2	VUJIC VUKAN		SRB - SERBIA	
3	DIMITROV TODOR		BUL - BULGARIA	
3	BARTSOKAS KONSTANTINOS		GRE - GREECE	
5	MAKSIMOVIC ALEKSA		SRB - SERBIA	
5	POPOV MIHAIL		BUL - BULGARIA	
7	IVANISEVIC VUJO		MNE - MONTENEGRO	
7	SAHIN DENIZ AREL		TUR - TURKIYE	
9	KARAKONTIS MICHAIL ANGELOS		GRE - GREECE	
9	ATANASOV DELYAN		BUL - BULGARIA	

13 Yrs Kumite Male -50 kg

1	AYKAN ALI OSMAN EGE		TUR - TURKIYE	
2	OZDEMIR YUSUF SELMAN		TUR - TURKIYE	
3	AVRAMOVIC ALEKSANDAR		SRB - SERBIA	
3	ZUGIC LUKA		SRB - SERBIA	
5	RADOVIC LUKA		SRB - SERBIA	
5	ADILOVIC HAMZA		BIH - BOSNIA AND HERZEGOVINA	
7	GORICAN ZAN		SLO - SLOVENIA	
7	USKOKOVIC LAZAR		SRB - SERBIA	
9	SHALA ISA		KOS - KOSOVO	
9	ERDESI PETAR		CRO - CROATIA	

13 Yrs Kumite Male -55 kg

1	MENGUVERDI CINAR		TUR - TURKIYE	
2	DINLER KUZHEY		TUR - TURKIYE	
3	PENO NESTOR		BIH - BOSNIA AND HERZEGOVINA	
3	DOLENSKI MARTIN		BUL - BULGARIA	
5	AKSAMOVIC ELMEDIN		BIH - BOSNIA AND HERZEGOVINA	
5	SARICA ILKAN ILHAMI		TUR - TURKIYE	
7	IOSIFIDIS EKTORAS		GRE - GREECE	
7	ASHANI ZEJD		MKD - NORTH MACEDONIA	
9	IVANOV NOVKO		BUL - BULGARIA	
9	PANAGAKOS PARIS		GRE - GREECE	

13 Yrs Kumite Male 55+ kg

1	BADURINA ADRIAN		CRO - CROATIA	
2	IVANOV ALEKSANDAR		BUL - BULGARIA	
3	ALIBEGOVIC EMRAH		BIH - BOSNIA AND HERZEGOVINA	
3	MUJEZINOVIC IMRAN		BIH - BOSNIA AND HERZEGOVINA	

30th Balkan Karate Championships for
Children 2026 - Istanbul - 2026-05-29

Official Results

5	HUSIC DENIAL		BIH - BOSNIA AND HERZEGOVINA	
5	KEKIC EMAN		BIH - BOSNIA AND HERZEGOVINA	
7	BOLUKBAS HUSEYIN TALHA		TUR - TURKIYE	
7	SADIKU LEART		KOS - KOSOVO	
9	METAXAS FILIPPOS		GRE - GREECE	
9	KODAK CINAR EFE		TUR - TURKIYE	
11	DJUKANOVIC LUKA		MNE - MONTENEGRO	

8 Yrs Kata Individual Female

1	POLYKANDRIOTI DIMITRA		GRE - GREECE	
2	AYVENLI AYSE BETUL		TUR - TURKIYE	
3	GLENTI DIMITRA		GRE - GREECE	
3	KOKAN KARLA		CRO - CROATIA	
5	POTSI NATALIA		GRE - GREECE	
5	VELJIC VERONIKA		BIH - BOSNIA AND HERZEGOVINA	
7	HASANOVIC SAFIJA		BIH - BOSNIA AND HERZEGOVINA	
7	PAPADIMA SOFIA		GRE - GREECE	
9	SAHIN SINEM ECE		TUR - TURKIYE	

8 Yrs Kata Individual Male

1	TAC KAAAN AYAZ		TUR - TURKIYE	
2	YOLCU ALI OSMAN		TUR - TURKIYE	
3	KASALICA NIKOLA		MNE - MONTENEGRO	
3	HADZAJLIC DZENAN		MNE - MONTENEGRO	
5	PALDIR ASAF CAGAN		TUR - TURKIYE	
5	VLAISAVLJEVIC ALEKSA		SRB - SERBIA	
7	MARKOVIC OGNJEN		MNE - MONTENEGRO	
7	MILACIC LAZAR		MNE - MONTENEGRO	
9	STEFANOVIC SERGEJ		SRB - SERBIA	
9	FERHATBEGOVIC ADI		BIH - BOSNIA AND HERZEGOVINA	

8-9 Yrs Kata Team Female

1	SERBIA - DAMLJANOVIC DUNJA - DOSTANIC ANJA - KRIVACIC DANICA - RADOMAN UNA		SRB - SERBIA	
2	MONTENEGRO - BRAUNOVIC NADJA - BULATOVIC MILJANA - SESTOVIC MASA		MNE - MONTENEGRO	
3	GREECE - POLYKANDRIOTI DIMITRA - GLENTI DIMITRA - VASILEIOU ELENI - POTSI NATALIA		GRE - GREECE	
3	BULGARIA - DIMITROVA DANAYA - NIKOLOVA IVAYLA - PELTEKOVA VIKTORIA		BUL - BULGARIA	
5	TURKIYE		TUR - TURKIYE	

30th Balkan Karate Championships for
Children 2026 - Istanbul - 2026-05-29

Official Results

	- AYDIN ISIK - BALIKCI MERYEM NUR - BOGA RAVZA - CIMEN EBRAR			
5	TURKIYE - DANLI ZEYNEP ESLEM - ERKOL AHSEN SULTAN - ITIL ELIF		TUR - TURKIYE	

8-9 Yrs Kata Team Male

1	MONTENEGRO - KASALICA NIKOLA - KRSTAJIC DANILO - ZEKOVIC KOCA		MNE - MONTENEGRO	
2	MONTENEGRO - MARKOVIC OGNJEN - MIJOVIC PAVLE - PAJOVIC MAKSIM - SEKULARAC STRAHINJA		MNE - MONTENEGRO	
3	BULGARIA - DIMITROV EMILIYAN - GEORGIEV RADOSTIN - VASILEV EMIL		BUL - BULGARIA	
3	BOSNIA AND HERZEGOVINA - FERHATBEGOVIC ADI - FERHATOVIC DAVUD - MEHMEDOVIC ADEMIR - ORESKOVIC DEAN		BIH - BOSNIA AND HERZEGOVINA	
5	TURKIYE - OZDOGAN EMIR YAGIZ - KESKIN AYAZ - AGAAGLU UMUT ARAS - SENGIL YUNUS EMRE		TUR - TURKIYE	
5	TURKIYE - CEBECI OMER ASIM - KARADENIZ EGEMEN YILMAZ - VURCAN EDIZ GOKHAN		TUR - TURKIYE	

9 Yrs Kata Individual Female

1	VASILEIOU ELENI		GRE - GREECE	
2	NIKOLOVA KRASINA		BUL - BULGARIA	
3	SKEVI ALEXANDRA		GRE - GREECE	
3	AKGUN AYZA		TUR - TURKIYE	
5	BULATOVIC MILJANA		MNE - MONTENEGRO	
5	GOCEN ELA GUL		TUR - TURKIYE	
7	MARTI BOJANA		SRB - SERBIA	
7	DAMLJANOVIC DUNJA		SRB - SERBIA	
9	KREMO EMINA		BIH - BOSNIA AND HERZEGOVINA	
9	MAHMUTOVIC FARAH		BIH - BOSNIA AND HERZEGOVINA	

9 Yrs Kata Individual Male

1	DIMITROV EMILIYAN		BUL - BULGARIA	
2	MAHMUTAGIC OMAR		BIH - BOSNIA AND HERZEGOVINA	
3	DERECI RASIM POYRAZ		TUR - TURKIYE	
3	PAJOVIC MAKSIM		MNE - MONTENEGRO	
5	ATHANASOULOPOULOS MAXIMOS		GRE - GREECE	

30th Balkan Karate Championships for
Children 2026 - Istanbul - 2026-05-29

Official Results











5	KESGIN MUHAMMET ALI		TUR - TURKIYE	
7	CEBECI OMER ASIM		TUR - TURKIYE	
7	CUVAL ERALP UMUT		TUR - TURKIYE	
9	ITIL MEHMET AYTUG		TUR - TURKIYE	
9	TALIC DINO		BIH - BOSNIA AND HERZEGOVINA	

The text 'MEDAL STANDING' is centered in a white, bold, sans-serif font. The background is a dark blue and black digital-themed graphic with a world map silhouette, light trails, and a hexagonal pattern.

MEDAL STANDING

30th Balkan Karate Championships for
Children 2026 - Istanbul - 2026-05-29

Medals - National Federation

Rank	National Federation	1. Place	2. Place	3. Place
1	 TURKIYE, TUR	19	25	36
2	 MONTENEGRO, MNE	10	8	23
3	 SERBIA, SRB	9	3	13
4	 BOSNIA AND HERZEGOVINA, BIH	8	10	16
5	 GREECE, GRE	5	2	9
6	 CROATIA, CRO	4	3	8
7	 BULGARIA, BUL	2	2	7
8	 NORTH MACEDONIA, MKD	1	3	1
9	 ROMANIA, ROU	0	1	3
10	 KOSOVO, KOS	0	1	0